

## Reda Instrumente GmbH

Gänsäcker 34 · P.O. Box 131  
D-78532 Tuttlingen

Telefon +49 / 74 62 / 94 45-0

Telefax +49 / 74 62 / 94 45-20

E-mail: [info@Reda-Instrumente.de](mailto:info@Reda-Instrumente.de)

<http://www.Reda-Instrumente.de>

Ausgabe Nr. 8

Datum: 02/2014

Charrière (Ch) French (F)	Durchmesser in mm	Inches
1	0,33	0,013
2	0,67	0,025
3	1,00	0,039
4	1,33	0,051
5	1,67	0,065
6	2,00	0,0787
7	2,33	0,092
8	2,67	0,105
9	3,00	0,1181
10	3,33	0,131
11	3,67	0,144
12	4,00	0,1575
13	4,33	0,170
14	4,67	0,184
15	5,00	0,1968
16	5,33	0,210
17	5,67	0,223
18	6,00	0,2362
19	6,33	0,249
20	6,67	0,263
21	7,00	0,2756
22	7,33	0,288
23	7,67	0,302
24	8,00	0,3150
25	8,33	0,328
26	8,67	0,341
27	9,00	0,3543
28	9,33	0,367
29	9,67	0,380
30	10,00	0,3973
31	10,33	0,407
32	10,67	0,420
34	11,33	0,446
36	12,00	0,4724
38	12,67	0,494
40	13,33	0,5199
45	15,00	0,5905

Gauge (G)	Durchmesser in mm	Inches
35	0,13	0,005
34	0,18	0,007
33	0,20	0,008
32	0,23	0,009
31	0,25	0,010
30	0,30	0,012
29	0,33	0,013
28	0,36	0,014
27	0,41	0,016
26	0,46	0,018
25	0,51	0,020
	0,53	0,021
24	0,56	0,022
23	0,64	0,025
22	0,71	0,028
21	0,81	0,032
20	0,89	0,035
	0,97	0,038
19	1,07	0,042
18	1,27	0,050
17	1,50	0,059
16	1,65	0,065
15	1,83	0,072
14	2,11	0,083
13	2,41	0,095
12	2,77	0,109
11	3,05	0,120
10	3,40	0,134
9	3,76	0,148
8	4,19	0,165
7	4,57	0,180
6	5,16	0,203

1 OZ	0,028 ml
5 OZ	0,140 ml
16 OZ	0,450 ml

35 OZ	1,0 l
128 OZ	3,7 l



---

## GARANTIE / WARRANTY / GARANTIA / GARANZIA

### GARANTIE

Wir gewähren auf alle **Reda**-Instrumente 5 Jahre Garantie.  
Voraussetzung ist der sach- und fachgerechte Einsatz der Instrumente.  
Von der Garantie sind Verschleißerscheinungen ausgeschlossen.

---

### WARRANTY

Our **Reda** products are free from manufacturing defects in material and workmanship. We therefore give on all instruments a guarantee of five years provided that the instruments are maintained and cleaned properly and used normally for their intended purpose.

---

### GARANTIA

Estamos convencidos de nuestra calidad y concedemos a todos los instrumentos de **Reda** 5 años de garantía contra cualquier defecto de fabricación, siempre y cuando se usen adecuadamente. De la garantía excluimos la manifestación de desgaste.

---

### GARANZIA

Siamo convinti della nostra qualità e concediamo cinque anni di garanzia sulla funzione dei tutti gli strumenti **Reda** sotto la presupposizione che l'utilizzo è da esperto.  
Escluso della garanzia sono tracce di consumo.

## **Arbeitsanweisung**

### **Aufbereitung (Reinigung) und Sterilisation von resterilisierbaren chirurgischen Instrumenten**

DIN EN ISO 17664:2004 (D)

Hersteller:  
REDA Instrumente GmbH, Gänsäcker 34  
78532 Tuttlingen

Alle von Reda gelieferten wieder verwendbaren Instrumente wurden ausschließlich für den chirurgischen Gebrauch konstruiert und dürfen zu keinen anderen Zwecken benutzt werden. Unsachgemäße Handhabung und sorglose Pflege sowie zweckentfremdeter Gebrauch können zu vorzeitigem Verschleiß der Instrumente führen. Die Produkte sind bei der Auslieferung nicht sterilisiert.

#### **Reinigungsvorbereitung**

Fabrikneue Instrumente müssen vor der ersten Anwendung den gesamten Aufbereitungsprozess durchlaufen. Instrumente unmittelbar nach Anlieferung aus den Folienverpackungen entnehmen und in trockenen Räumen bei gleichbleibender Raumtemperatur lufttrocknen lagern, um Kondensationsbildung zu vermeiden. Die Instrumente keinen Sonnenlichteinstrahlungen oder Dämpfen durch Chemikalien (Säuren oder scharfe Reinigern) aussetzen. Vor der ersten Sterilisation alle Schutzkappen und Folien vollständig entfernen und anschließend reinigen.

Gebrauchte Instrumente unmittelbar nach Beendigung des Eingriffs von Blut, Gewebe und Arzneimittel reinigen. Instrumente in eine freigegebene Lösung eines kombinierten Reinigungs- und Desinfektionsmittels, das keine proteinfixierende Wirkung besitzt, einlegen. Dosierung des Herstellers beachten. Nicht in NaCl Lösung einlegen, ansonsten Gefahr für Loch- bzw. Spannungsriss-Korrosion

Überfüllung von Instrumentensieben und Wasch-Trays vermeiden.

Gelenkinstrumente vor dem Aufbereiten öffnen. Zerlegbare Instrumente gemäß Bedienungsanleitung (Piktogramm) zur Reinigung zerlegen. Reinigungsgerechtes Zubehör verwenden. Für die manuelle Reinigung nie Metallbürsten oder Metallschwämme verwenden. Spülmaschinen und Ultraschallanlagen nicht überladen. Spül- oder Schallschatten vermeiden. Dosierung, Einwirkzeit und Einwirktemperatur bei der Desinfektion und Reinigung unbedingt einhalten. Nach der Reinigung sorgfältig spülen. Möglichst vollentsalztes (demineralisiertes) Wasser verwenden. Nach dem Spülen ausreichend trocknen. Abgenutzte, korrodierte, deformierte, poröse oder anderweitig beschädigte Instrumente aussortieren.

Aus hygienischen Gründen müssen Instrumente, die zur Reparatur eingesandt werden komplett aufbereitet werden. Gelenkinstrumente nach jeder Aufbereitung mit einem Pflegemittel auf Basis von Paraffinöl behandeln (gilt nicht für flexible Endoskope und Zubehör). Funktionsprüfung in zusammengebautem Zustand durchführen. Instrumente mit Rastensperre vor der Sterilisation nur im ersten Zahn schließen.

Als Sterilisationsverfahren empfehlen wir die Dampfsterilisation (üblicherweise mit Sattedampf bei 134° C)

Sterilisation ist kein Ersatz für Sauberkeit!

Die Broschüre "Instrumenten-Aufbereitung richtig gemacht" des Arbeitskreis Instrumenten-Aufbereitung dient als Anhalt.

Reda Instrumente GmbH  
78532 Tuttlingen



## IMPORTANT INFORMATION CONCERNING PREPARING AND STERILIZING SURGICAL INSTRUMENTS

Dear Sirs,  
please read the following instructions very carefully before using the instruments.

### 1. INITIAL USE

All instruments which are being used for the first time must be thoroughly cleaned, rinsed and then sterilized before using.

### 2. TREATING INSTRUMENTS AFTER USAGE

- a.) The instruments might be immediately thoroughly cleaned and disinfected. Please follow the manufacturer's instructions when using cleaning agents and disinfectants.
- b.) Instruments which may be dismantled must be cleaned and disinfected after being taken apart.
- c.) Cleaning may be carried out either manually or with a machine. Care should be taken that only cleaning agents and disinfectants are used, which are changed daily.
- d.) Following chemical disinfection and manual cleaning, all instruments must always be thoroughly rinsed under running water.
- e.) The temperature of water used in a machine for cleaning should not exceed 45°C.
- f.) Whether cleaning is carried out manually or by machine, we especially ask you to ensure that the correct dosage for cleaning solutions or the correct combination of disinfectant and cleaning solution, is employed. Similar importance should be applied to the length of time the agents require to perform properly and to the temperature set.
- g.) Hinged instruments should be opened before cleaning.
- h.) Please ensure that the perforated instrument trays, when loaded, do not exceed 10 kg in weight.
- i.) Please take care that when instruments are being cleaned they are arranged proper in a manne that fluids can circulate freely.
- j.) Deposits remaining after the cleaning process must be completely removed in the first rinse which now follows. The optimum temperature for final rinsing has proved to be between 70° and 90° C. Please use only purified water in this final cleaning stage.
- k.) The instruments must be carefully dried after cleaning and rinsing is completed.
- l.) Moving parts and the cutting edges of shears and scissors must be treated with preservatives which are both suitable and physiologically safe.

### 3. TESTING FOR CORRECT FUNCTIONING

- a.) Instruments must be carefully and thoroughly checked before every occasion that they are used.

- b.) After each time they are cleaned, the instruments must be macroscopically clean, i.e., visibly free from proteinbased residues and other soiling.
- c.) Care should be taken so that cracks, breakages and corrosion are noticed.
- d.) Instruments with flecks should be separated and taken out for special treatment.
- e.) All moving parts as well as working tips and blades should be checked with special care.
- f.) Checking should be carried out according to the extent to which the instruments will be used.
- g.) Instruments which are in any way defective or damaged should be immediately sorted out from the others.

### 4. STERILIZATION

- a.) All stainless steel surgical instruments supplied by us may be sterilized in an autoclave.
- b.) Please follow the manufacturer's operating instructions when using autoclave. All machines used must comply with all current quality and other standards.
- c.) Instruments are being sterilized/ autoclaved at a temperature of 134°C.
- d.) Sterilization packing material must comply with all current standards.
- e.) Instruments with ratchets or self-retaining mechanisms should be sterilized opened or in the first ratchet position.
- f.) Please ensure that perforated instrument trays, when loaded do not exceed 10 kg in weight.

### 5. IN GENERAL

- a.) All surgical instruments supplied by us have been thoroughly inspected before dispatch and leave our factory in perfect condition. Damage which can arise as a result of transporting, cleaning, preserving, sterilizing or storing, must be prevented.
- b.) Please handle surgical instruments always with the utmost care.
- c.) Instruments must be stored in a clean and dry place.
- d.) If you have any queries or problems please contact us at any time:

We should like to point out that, if the above-mentioned directions are not followed or the instruments supplied by us are not properly used, all guarantee claims become void and any consequences must be borne by yourselves.

## SUGERENCIAS PARA LA LIMPIEZA, ESTERILIZACIÓN Y MANTENIMIENTO DE INSTRUMENTOS QUIRÚRGICOS

### ENJUAGADO

Tras el uso enjuagar enseguida los instrumentos bajo un chorro de agua caliente (no hirviendo). El enjuagado debe servir para quitar los residuos de sangre, mucosas y tejidos.

### LIMPIEZA

Si la limpieza no se efectúa inmediatamente después del enjuagado, los instrumentos tienen que sumergirse en una solución de agua y detergente con PH neutro (7)

Para los instrumentos muy delicados (algunos tipos de porta agujas o tijeras se aconseja una limpieza manual: ver punto "C").

#### a.- Limpieza en la pila de ultrasonido

Los instrumentos tienen que estar en la pila el tiempo necesario recomendado por el fabricante para efectuar el ciclo del lavado, generalmente de 5 a 10 minutos.

Los instrumentos con bisagras o juntas (articulaciones) tienen que sumergirse en la pila en posición abierta.

Asegurarse de que las hojas afiladas de las tijeras, bisturís para gingivectomía, curetas, etc. no estén en contacto con otros instrumentos.

Todos los instrumentos deben estar completamente sumergidos en la solución de lavado.

No poner instrumentos de diferentes metales (acero inoxidable, instrumentos cromados, latón, etc.) en el mismo ciclo de lavado.

Cambiar a menudo la solución para el lavado, como mínimo todas las veces que lo recomienda el fabricante de la pila de ultrasonidos.

Enjuagar concienzudamente los instrumentos con agua corriente tras lavado con ultrasonidos para quitar los residuos de la solución de lavado.

#### b.- Limpieza con lavadora

Seguir las indicaciones del fabricante. Asegurarse de que los instrumentos hayan sido lubricados tras el último ciclo de lavado y antes del ciclo de esterilización.

#### c.- Limpieza manual

La mayor parte de los fabricantes de instrumentos indican el lavado con los ultrasonidos como el modo mejor y más eficaz para limpiar los instrumentos quirúrgicos, especialmente los que tienen bisagras, cierres y en general articulaciones. Si la limpieza con los ultrasonidos no es posible, se aconseja usar el método siguiente:

- Usar cepillos rígidos de plástico, nylon, etc.
- Cepillar concienzudamente los instrumentos más delicados y, si es posible, enjuagar, limpiar y esterilizar estos instrumentos separadamente.
- Verificar que toda la superficie de estos instrumentos esté limpia.
- Tras haber cepillado los instrumentos, enjuagarlos bajo el chorro de agua corriente.
- Durante el enjuagado abrir y cerrar las tijeras, las pinzas hemostáticas, los porta agujas y los demás instrumentos con bisagras o juntas y asegurarse de que las partes internas de las bisagras estén perfectamente enjuagadas como la superficie externa del instrumento.

### SECADO, LUBRIFICACIÓN E INSPECCIÓN

Tras las operaciones de limpieza y de enjuagado, los instrumentos quirúrgicos tienen que ser secados perfectamente.

Todos los instrumentos con juntas o bisagras (acción "metal contra metal") como tijeras, pinzas hemostáticas, porta agujas, fórceps de extracción, etc., tienen que ser lubricados. Se aconsejan lubricantes específicos para el instrumental quirúrgico. No usar aceites o lubricantes industriales.

A este punto es buena norma inspeccionar el estado de cada instrumento y verificar el funcionamiento según el uso específico. Controlar y asegurarse de que:

- Las hojas de las tijeras estén lisas de arriba abajo y de que, una vez cerradas, no hagan juego. Probar las tijeras cortando gasa muy fina. Tres cuartas parte de la hoja tienen que cortar la gasa sin retenerla.
- Las puntas de las pinzas estén al mismo nivel.

- Las pinzas hemostáticas y los porta agujas no dejen pasar la luz entre las puntas cuando estén cerradas, se abran y cierren fácilmente y que las bisagras no estén demasiado flojas.
- Controlar el desgaste de la porta agujas sobre la superficie interna de las puntas.
- Las cánulas metálicas de aspiración estén bien limpias en su interior.
- Los instrumentos cortantes y los bisturís tengan las hojas bien afiladas y no estropeadas.

### ESTERILIZACIÓN EN AUTOCLAVE

Tras haber enjuagado, limpiado, secado, lubricado e inspeccionado los instrumentos, éstos pueden ser preparados para la esterilización separadamente o en serie.

Instrumentos individuales:

Las bolsas especiales monouso son el ideal para contener los instrumentos. Asegurarse de que las bolsas que contendrán los instrumentos con cierres y articulaciones (pinzas hemostáticas, porta agujas, etc.) sean lo bastante grandes como para contener los citados instrumentos en posición abierta.

Instrumentos en serie:

Poner los instrumentos en los especiales cestos o bandejas de acero inoxidable. Poner los instrumentos más pesados en la parte inferior cuando sean necesarias varias bandejas.

No cerrar nunca los instrumentos durante el ciclo en autoclave. Un instrumento cerrado no estará nunca bien esterilizado, ya que el vapor no puede penetrar en la parte de cierre a contacto "metal contra metal". En el instrumento podría además romperse en la parte de la bisagra a causa de la expansión del metal debida al calor durante el ciclo del autoclave.

No cargar demasiado la cámara del autoclave ya que algunos instrumentos podrían formar "zonas de sombra" sobre otros en los que el vapor no penetraría.

### ATENCIÓN

Al final del ciclo de esterilización - antes del ciclo de secado- abrir ligeramente la portezuela del autoclave y preceder con el ciclo desecado según las instrucciones del fabricante. Si la portezuela del autoclave se abre completamente antes del ciclo de secado, el aire frío de la habitación entraría en la cámara del autoclave causando la formación de condensación sobre los instrumentos y de consecuencia aparecerían las manchas de agua que vemos a menudo en los mismos.

### ESTERILIZACIÓN EN FRÍO:

La mayor parte de las soluciones para la esterilización en frío esterilizan los instrumentos completamente tras 10 horas de inmersión. Esta acción química prolongada puede ser más perjudicial para los instrumentos que el ciclo normal de 20 minutos en autoclave.

Si los instrumentos tienen necesidad de ser simplemente "desinfectados", el proceso en frío es adecuado, ya que la desinfección tiene lugar en 10 minutos solamente.

Recuerde bien la diferencia entre:

**ESTÉRIL** - término absoluto (ningún organismo logra sobrevivir) y

**DESINFECTADO** - perfectamente limpio.

Usen siempre la técnica más adecuada de esterilización/limpieza de los instrumentos según el uso que se haga posteriormente de ellos.

Recuerden que la esterilización de los instrumentos no sustituye la limpieza de los mismos.

Recomendamos no volver a usar ni esterilizar los artículos de un solo uso.

Si se tratan en el modo correcto los instrumentos contruidos con las modernas aleaciones inoxidables pueden durar muchos años.

## INDICAZIONI PER LA CURA, PULITURA E LA STERILIZZAZIONE DELLO STRUMENTARIO CHIRURGICO RISTERILIZZABILE

### Misure preventive anticorrosione

- 1) Raggruppare accuratamente gli strumenti correttamente confezionati e sterilizzati prima dell'operazione; selezionarli secondo l'intervento. Verificare sempre che la confezione esterna sia integra e che lo strumento stesso non sia danneggiato.
- 2) Assicurarsi tramite l'indicatore di sterilizzazione collocato all'interno del vaglio che il contenuto sia stato sterilizzato.
- 3) Disporre gli strumenti seguendo l'ordine di utilizzo durante l'operazione; lasciare gli strumenti non necessari nel vaglio; predisporre gli strumenti solo immediatamente prima dell'operazione.
- 4) Nel corso dell'operazione rimuovere dagli strumenti sangue ed altri materiali biologici; dopo l'uso, riporre gli strumenti nel corretto alloggiamento.
- 5) Risciacquare opportunamente gli strumenti cavi, al fine di evitare l'adesione di sangue e polvere d'osso.
- 6) Per la pulitura degli strumenti utilizzare una soluzione lattata o una soluzione salina, ma non immergerli nelle suddette soluzioni.
- 7) Iniziare l'operazione di pulitura subito dopo l'intervento. Strumenti utilizzati su pazienti con possibili infezioni: smaltire in modo analogo, eliminando sangue, polvere d'osso parti di tessuto in eccesso.
- 8) Pulire gli strumenti in un luogo previsto nell'ambito della sala operatoria.

Nel caso in cui gli strumenti vadano collocati direttamente nella centrale di sterilizzazione, è necessario dapprima coprirli, per evitare il rischio di contaminazione ai danni del personale o dell'ambiente circostante.

### Disinfezione

Durante l'uso di disinfettanti chimici è necessario osservare scrupolosamente le indicazioni del produttore; utilizzare le soluzioni sempre previa diluizione. Nella fase termica di disinfezione con acqua bollente assicurarsi che l'acqua sia priva di corpi estranei.

### Pulitura

Indipendentemente dal metodo utilizzato per la pulitura (meccanico o manuale) si raccomanda di verificare attentamente quale detergente vada utilizzato con ciascun metodo. Valori pH consigliati: tra 7,0 e 8,5.

### 1) Pulitura meccanica

Osservare scrupolosamente le istruzioni d'uso fornite dal produttore della macchina pulitrice. Predisporre gli

strumenti per la pulitura meccanica. Tutti gli strumenti appuntiti e delicati dovrebbero essere puliti manualmente.

Non sovraccaricare i vagli, mettere gli strumenti pesanti sul fondo del vaglio. Se necessario, immergere e risciacquare gli strumenti molto sporchi (strumenti cavi), prima di collocarli nella lavatrice.

### 2) Pulitura ad ultrasuoni

#### (fa parte dei metodi di pulitura meccanica)

Prima di inserire uno strumento nel bagno ad ultrasuoni, rimuovere i materiali organici in eccesso. I bagni ad ultrasuoni sono consigliati per le filettatrici o gli strumenti con solchi profondi. L'ultrasuono deve essere seguito da un programma di risciacquo normale.

### 3) Pulitura manuale

Richiede diverse spazzole in nylon, una canna da soffio ed un ugello da soffio/ un dispositivo ad aria compressa pulito, detergenti e solventi come per la pulitura meccanica.

Per gli additivi di pulitura osservare le indicazioni fornite dal produttore.

Per la pulitura degli strumenti dotati di cannula, passare più volte lo spazzolino di nylon attraverso la cannula eseguendo movimenti rotatori (non utilizzare spazzole in lana d'acciaio/metallo) fino alla completa rimozione dei residui eliminabili con questo metodo.

Soffiare poi con aria compressa nella cannula.

### 4) Asciugatura

Ogni strumento deve essere asciugato completamente sia internamente che esternamente per evitare la formazione di ruggine o malfunzionamenti.

### Indicazioni per la sterilizzazione della strumentazione

Pulire immediatamente ed asciugare bene gli strumenti usati, non utilizzare detergenti e disinfettanti con additivi fortemente acidi o alcalini (ad es. soda, soda caustica o acidi)!

### Sterilizzare la strumentazione solo a vapore A 134°!

Prima della sterilizzazione, assicurarsi che gli strumenti siano perfettamente funzionanti ed integri. La sterilizzazione non sostituisce la pulitura.



## Index

03: Diagnostik  
05: Narkose  
07: Skalpelle, Messer  
09: Scheren  
10: Mikroscheren  
11: Pinzetten  
12: Mikrochirurgie-Pinzetten  
  
13: Klemmen  
15: Tuchklemmen  
17: Tupferzangen  
19: Wundhaken  
21: Sonden, Watteträger  
23: Trokare, Biopsiekanülen, Führungsnadeln  
  
25: Nadelhalter  
27: Naht  
29: Sterilisations-Instrumente  
  
31: Verband, Gips  
33, 34: Knochenchirurgie  
41: Neurochirurgie  
43, 44: Ophthalmologie  
45: Otologie  
47: Rhinologie  
49: Mund und Zunge  
51: Tonsillektomie  
53: Laryngo-, Bronchoskopie  
55: Tracheotomie  
57: Thorax  
61: Herz- und Gefäßchirurgie  
63: Galle  
65: Magen, Darm  
67: Urologie  
69: Rektum  
71: Gynäkologie  
73: Geburtshilfe  
75: Dermatologie  
89: Sterilisation, Behälter  
91: Hochfrequenz-Chirurgie

## Index

Diagnostic  
Anesthesia  
Scalpels  
Scissors  
Micro Scissors  
Thumb and Tissue Forceps  
Microsurgery Forceps  
Atrauma Bulldog Clamps  
Hemostatic Forceps  
Towel Forceps  
Dressing Forceps  
Retractors  
Probes, Cotton Applicators  
Trocars  
  
Needle Holders  
Suturing Instruments  
Sterilization Instruments  
  
Plaster of Paris  
Bone Surgery  
Neurosurgery  
Ophtalmology  
Otology  
Rhinology  
Mouth and Tongue  
Tonsils  
Larynx  
Tracheotomy  
Thorax  
Cardiovascular Surgery  
Gall and Kidney  
Intestines, Stomach  
Urology  
Rectum  
Gynecology  
Obstetrics  
Dermatology, Hygiene  
Different Containers  
High Fequency Surgery

## Indice

03:	Diagnóstico
05:	Anestesia
07:	Bisturíes
09:	Tijeras
10:	Tijeras p/micro cirugía
11:	Pinzas de disección
12:	Pinzas p/micro cirugía Clamp Atrauma Bulldog
13:	Pinzas hemostáticas
15:	Pinzas de campo
17:	Pinzas p/tapones
19:	Separadores
21:	Sondas, Porta-algodón
23:	Trócares
25:	Porta-agujas
27:	Instrumentos para sutura
29:	Instrumentos para la esterilización
31:	Vendajes enyesados
33, 34:	Cirugía ósea
41:	Neurocirugía
43, 44:	Oftalmología
45:	Otología
47:	Rinología
49:	Boca y lengua
51:	Amígdalas
53:	Laringe
55:	Traqueotomía
57:	Tórax
61:	Cirugía cardiovascular
63:	Vesícula biliar
65:	Intestinos, Estómago
67:	Urología
69:	Recto
71:	Ginecología
73:	Obstetricia
75:	Dermatología, Higiene
89:	Contenedores varios
91:	Electrocirugía

## Index

Diagnostica
Anestesia
Bisturi
Forbici
Forbici per microchirurgia
Pinze per dissezione
Pinze per microchirurgia
Pinze Atrauma Bulldog
Pinze emostatiche
Pinze fissateli
Pinze per medicatura
Divaricatori
Sonde, Portacotone
Trequarti
Port'aghi
Strumenti per suture
Strumenti per la sterilizzazione
Bendaggi gessati
Chirurgia ossea
Neurochirurgia
Oftalmologia
Otologia
Rinologia
Bocca e lingua
Tonsille
Laringe
Tracheotomia
Torace
Chirurgia cardiovascolare
Vescicola biliare, rene
Intestini, Stomaco
Urologia
Retto
Ginecologia
Ostetrica
Dermatologia, Igiene
Vassoi diversi
Elettrochirurgia

Die Firma REDA Instrumente GmbH wurde im September 1990 gegründet. Ziel der Firmengründung war die Herstellung und der Vertrieb von chirurgischen Instrumenten.

Von anfangs 3 Mitarbeitern ist die Firma REDA innerhalb von sechs Geschäftsjahren zu einem mittelständischen Unternehmen gewachsen. Die Betriebsgröße beträgt heute mehr als 30 Mitarbeiter. Firma REDA exportiert in fast alle Länder der Welt und stellt dem Kunden weltweit Produkte und Dienstleistungen mit hoher Qualität zur Verfügung. Die Erwartungen der Kunden sollen stets erfüllt werden.

Um dieses zu erreichen, sind zufriedene und motivierte Mitarbeiter notwendig. Aus diesem Grund besitzen alle Mitarbeiter einen hohen Grad an Selbständigkeit und Eigenverantwortung für das Unternehmen. Darüber hinaus wird der familiäre Charakter seitens der Geschäftsführung unterstrichen und gefördert.

Der partnerschaftliche Stil setzt sich auch im hohen Maße bei den Geschäftsbeziehungen mit unseren Lieferanten und Kunden durch. Ziel ist es, Fehler zu vermeiden und kostenbewußt zu handeln.

Durch den Aufbau und den Unterhalt eines Qualitätsmanagementsystems nach den GMP regulation of the FDA, der DIN ISO 13485, Richtlinie 93/42 und die Zertifizierung des Systems wollen wir die erreichte Marktposition und Wettbewerbsfähigkeit halten und in der Zukunft weiter ausbauen.

In Zusammenarbeit mit Ärzten entwickeln, fertigen und vertreiben wir in den Bereichen:

- Allgemein- und Viszeralchirurgie
- Gefäß-, Mikro- und Neurochirurgie
- Herz- und Thoraxchirurgie
- Gynäkologie und Urologie
- HNO, Ophthalmologie
- Orthopädie
- Plastische Chirurgie
- Laparoskopie
- Endo-Neurochirurgie
- Arthroskopie
- Sinuskopie
- Cystoskopie
- Hysteroskopie
- Gynäkologie

Sehr gut ausgebildetes Personal und ein umfassender Maschinenpark ermöglichen es uns, die hohe Qualität und Präzision unserer Produkte umzusetzen und zu erreichen.

Unsere moderne EDV und die schlanke Organisation sind die wichtigsten Bestandteile unserer hohen Produktivität. Dadurch können wir unseren Kunden stets eine hohe Lieferbereitschaft und Flexibilität garantieren.

REDA Instrumente GmbH  
Deutschland - Tuttlingen, 02/2014

REDA INSTRUMENTS GmbH was founded in September 1990. Starting with just three employees, REDA has grown within six years to a company who now employs over thirty people while still retaining the values of a family run business, and we pride ourselves on our customer service.

REDA exports to countries all over the world, offering to their customers a full range of surgical instruments.

REDA has a first class quality management system built upon the regulations of the FDA. In 1997 we became registered to DIN ISO 13485 and EEC 93/42.

REDA are able to offer a complete range of surgical instruments covering all types of surgery, including:

- General and Visceral Surgery
- Micro- Neuro- and Vascular Surgery
- Heart and Thorax Surgery
- Gynaecology
- ENT, Ophtalmology
- Orthopaedics etc.
- Laparoscopy
- Endo-Neurosurgery
- Arthroscopy
- Urology
- Gynaecology

We strive to offer first class products, manufactured by our highly trained precision engineers using most up to date C & C machines.

At our modern offices, together with modern technology, we can offer our customers a fast and efficient service from our large stocked warehouse.

REDA Instrumente GmbH  
Deutschland - Tuttlingen, 02/2014



REDA Instrumente GmbH fundada en 1990 en Tuttlingen, Alemania, comenzó con éxito y con la intención de ocupar un lugar de privilegio como líder en la fabricación y venta internacional de instrumentos quirúrgicos de calidad superior.

Nuestra compañía comenzó con un pequeño staff integrado por el grupo familiar y fué creciendo con paso firme contando en la actualidad con un personal capacitado de aproximadamente 30 operarios y con presencia internacional a través de sus distribuidores en las principales capitales del mundo.

Un gran porcentaje de nuestra producción se compone de productos solicitados bajo características y marcas de nuestros clientes.

Con el objetivo de asegurar nuestro alto nivel de calidad nuestra empresa mantiene un staff muy entusiasta acompañado de una integrada relación con la gerencia, independencia en el empleo y motivación propia para el bienestar del personal.

Nos satisface trabajar junto a nuestros proveedores y en busca de un claro objetivo que nos permita lograr mutuos beneficios. Estamos seguros que éste sistema de trabajo nos permite evitar errores y lograr una mejor manufacturación de nuestros productos, la mayoría de ellos se diseñan con la colaboración y asesoramiento de médicos profesionales.

Nuestras especialidades en cirugía incluyen instrumentos para:

- cirugía general y visceral
- cirugía vascular, microcirugía, neurocirugía
- cirugía cardiovascular
- ginecología y urología
- ORL, Oftalmología
- Ortopedia
- cirugía plástica
- Laparoscopia
- Endo-neurocirugía
- Atroscopia
- sinuscopia
- cistoscopia
- histeroscopia
- ginecología

Estamos orgullosos de nuestra calidad, manteniendo periódicamente los tests correspondientes de GMP que exigen los standards regulares de agencias tales como la FDA, contando con los certificaciones de DIN ISO 13485 and EEC 93/42.

Desde los inicios, a través de modernos equipos computarizados logramos producir solamente instrumental de alta calidad.

REDA Instrumente GmbH  
Deutschland - Tuttlingen, 02/2014

La REDA Instrumente GmbH fondata nel 1990 a Tuttlingen in Germania incominciò con l'intenzione di produrre e vendere strumenti chirurgici di qualità superiore sul mercato internazionale.

La nostra ditta incominciò con uno staff di 3 persone che attualmente è cresciuto a circa 30 persone con una presenza internazionale in tutti i paesi del mondo.

Una grande percentuale della nostra produzione è composta di prodotti richiesti a base caratteristiche e con il marchio dei nostri clienti.

Per poter assicurare il nostro alto livello di qualità la nostra impresa tiene uno staff molto entusiasta accompagnato da una relazione con la direzione, l'indipendenza e la propria motivazione per il benessere del personale.

Noi desideriamo lavorare in relazioni commerciali fra il fornitore ed il cliente, quale ci permette di ottenere un effetto utile reciproco. Siamo sicuri che questo tipo di collaborazione aiuta a limitare malintesi ed errori nella produzione e fornitura dei nostri prodotti. La maggiore parte dei nostri prodotti vengono sviluppati con la collaborazione di chirurghi professionali.

Le nostre specialità nella chirurgia includono strumenti per:

- Chirurgia generale e viscerale
- Micro chirurgia, neurochirurgia, chirurgia per vasi
- Chirurgia cardiovascolare e toracica
- Ginecologia e urologia
- ENT, oftalmologia
- Ortopedia
- Chirurgia plastica
- Laparoscopia
- Endo neurochirurgia
- Artroscopia
- Sinuscopia
- Cistoscopia
- Isteroscopia
- Ginecologia

Siamo orgogliosi della nostra qualità mantenuta periodicamente con i test corrispondenti agli standard GMP che mantengono o superano gli standard regolari come tali della FDA, la certificazione DIN ISO 13485 and EEC 93/42. Il nostro sistema moderno computerizzato ci permette di produrre solamente strumenti di alta qualità.

REDA Instrumente GmbH  
Deutschland - Tuttlingen, 02/2014

Blutdruckmeßgeräte  
Sphygmomanometer  
Esfigmomanómetros  
Sfigmomanometri



**DIPLOMAT  
PRESAMETER**

Preiswertes und sehr beliebtes Quecksilbergerät in Metalltui. Lichtgraue Kunststoffbeschichtung. Glasröhre von höchster Präzision mit Innendurchmesser 4,2 mm +/- 0,2 mm. Gute Ablesbarkeit der eloxierten Skala bis 300 mmHG. Vernickelte Metallteile. Mit Quecksilbersicherung. Maximale Fehlertoleranz des Gerätes: +/- 3 mmHg. Mit Latexpolster und verchromtem Ablaufventil.

**Nr. 03112-00 - Mit Wickelmanschette aus Baumwolle komplett mit Latexpolster 2-Schlauch.**

**Nr. 03112-01 - Mit Hakenmanschette aus Baumwolle komplett mit Latexpolster 2-Schlauch.**

**Nr. 03112-02 - Mit kalibrierter Nylon-Velcromanschette komplett mit Latexpolster 2-Schlauch.**

Economical and attractive mercurial sphygmomanometer in metal case. Enamelled in light gray color. Precision glass tube with inside diameter 4,2 mm +/- 0,2 mm. Anodized faceplate with easy-to-read graduated scale. Maximum reading 300 mmHg. Nickel-plated metal parts. Mercury lock. Maximum error throughout range +/- 3 mmHg. Complete with latex bulb and chrome-plated air-release valve.

**No. 03112-00 - With cotton bandage cuff complete with 2-tube latex bladder.**

**No. 03112-01 - With cotton hook cuff complete with 2-tube latex bladder.**

**No. 03112-02 - With calibrated nylon velcro complete with 2-tube latex bladder.**

Tensiómetro de mercurio económico y de una gran difusión en estuche metálico. Recubierto con plástico de color gris claro. Tubo vidrio de máxima precisión con diámetro interior de 4,2 mm +/- 0,2 mm. Lectura cómoda en la escala anodizada hasta 300 mmHg. Partes metálicas niqueladas. Tiene cierre de seguridad en el depósito de mercurio. Tolerancia de errores máxima del aparato +/- 3 mmHg. Pera latex y válvula cromada.

**No. 03112-00 - Con brazaletes de venda de algodón, completo, bolsa latex de 2 tubos.**

**No. 03112-01 - Con brazaletes de ganchos de algodón, completo, con bolsa latex de 2 tubos.**

**No. 03112-02 - Con brazaletes velcro de nilón, calibrado, completo con bolsa latex de 2 tubos.**

Sfigmomanometro a mercurio economico ed elegante in astuccio di metallo. Verniciato in grigio chiaro. Colonna di precisione di vetro con diametro interno 4,2 mm +/- 2 mm. Quadrante anodizzato con scala graduata di facile lettura. Valore massimo 300 mmHg. Parti metalliche nichelate. Chiusura di sicurezza del mercurio. Tolleranza +/- 3 mmHg. Completo di monopalla in latex e valvola di sfiato cromata.

**No. 03112-00 - Con bracciale di cotone a fascia, complete di camera d'aria in latex a due tubi.**

**No. 03112-01 - Con bracciale di cotone a ganci, completo di camera d'aria in latex a due tubi.**

**No. 03112-02 - Con bracciale calibrato velcro-nylon completo di camera d'aria in latex a due tubi.**

Blutdruckmeßgeräte  
Sphygmomanometer  
Esfigmomanómetros  
Sfigmomanometri

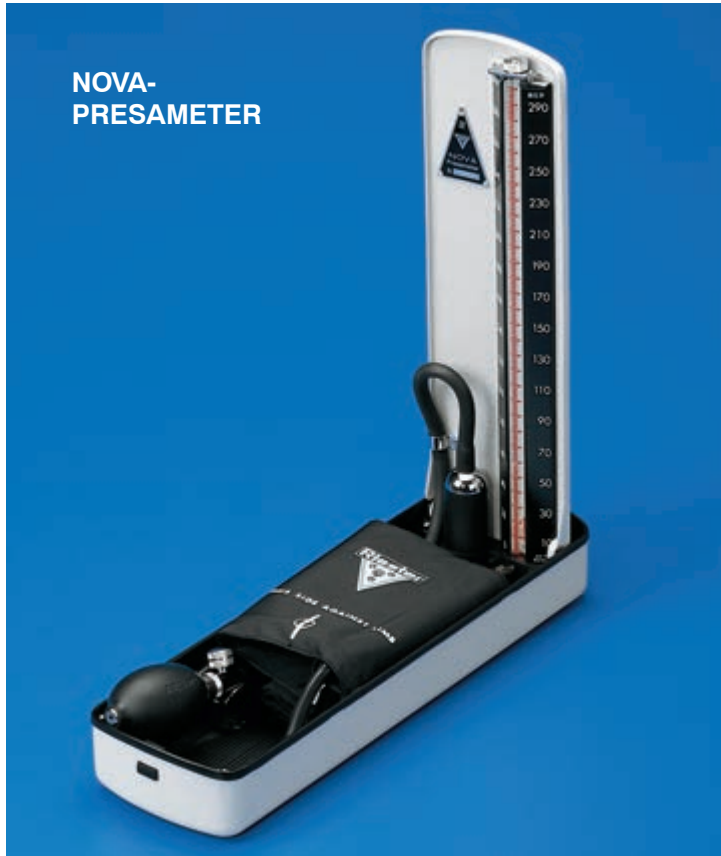

Qualitativ sehr hochwertiges Quecksilbergerät in Metallgehäuse mit 2-farbiger Einbrennlackierung (hellgrau und schwarz). Glasröhre von höchster Präzision mit Innendurchmesser 4,2 mm +/- 0,2 mm. Gute Ablesbarkeit der eloxierten Skala bis 300 mmHg. Verchromte Metallteile. Mit Quecksilbersicherung und Ballhalterung. Maximale Fehlertoleranz des Gerätes: +/- 3 mmHg. Mit Latexball und verchromtem Ablaßventil.

**Nr. 03113-00 - Mit Wickelmanschette aus Baumwolle komplett mit Latexpolster 2-Schlauch.**

**Nr. 03113-01 - Mit Hakenmanschette aus Baumwolle komplett mit Latexpolster 2-Schlauch.**

**Nr. 03113-02 - Mit kalibrierter Nylon-Velcromanschette komplett mit Latexpolster 2-Schlauch.**

High quality extra-sturdy mercurial sphygmomanometer in metal case. Enamelled in light gray with contrasting trim. Precision glass tube with inside diameter 4,2 mm +/- 0,2 mm. Anodized faceplate with easy-to-read graduated scale. Maximum reading 300 mmHg. Chrome-plated metal parts. Mercury lock. Bulb holder. Maximum error throughout range +/- 3 mmHg. With latex bulb and chrome-plated air release valve.

**No. 03113-00 - With cotton bandage cuff complete with 2-tube latex bladder.**

**No. 03113-01 - With cotton hook cuff complete with 2-tube latex bladder.**

**No. 03113-02 - With calibrated nylon velcro complete with 2-tube latex bladder.**

Tensiómetro de mercurio de alta calidad en estuche metálico barnizado al fuego en gris claro y negro. Tubo vidrio de precisión máxima con diámetro interior de 4,2 mm +/- 0,2 mm. Cómoda lectura de la escala anodizada hasta 300 mmHg. Partes metálicas cromadas. El depósito de mercurio lleva un cierre de seguridad. Soporte para pera. Tolerancia de errores máxima del aparato +/- 3 mmHg. Con pera latex y válvula cromada.

**No. 03113-00 - Con brazaletes de venda de algodón completo, con bolsa latex con 2-tubos.**

**No. 03113-01 - Con brazaletes de ganchos de algodón completo, con bolsa latex con 2-tubos.**

**No. 03113-02 - Con brazaletes velcro de nilón calibrado completo, con bolsa latex con 2-tubos.**

Sfigmomanometro a mercurio di alta qualità, molto robusto, in astuccio di metallo, verniciato in grigio chiaro con eleganti rifiniture. Colonna di precisione di vetro con diametro interno 4,2 mm +/- 0,2 mm. Quadrante anodizzato con scala graduata di facile lettura. Valore massimo 300 mmHg. Parti metalliche cromate. Chiusura di sicurezza del mercurio. Supporto per monopalla. Tolleranza +/- 3 mmHg. Con monopalla in latex e valvola di sfiato cromata.

**No. 03113-00 - Con bracciale di cotone a fascia completo di camera d'aria di latex a 2-tubi.**

**No. 03113-01 - Con bracciale di cotone a ganci completo di camera d'aria di latex a 2-tubi.**

**No. 03113-02 - Con bracciale calibrato velcro-nylon completo di camera d'aria di latex a 2-tubi.**

Blutdruckmeßgeräte  
Sphygmomanometer  
Esfigmomanómetros  
Sfigmomanometri

**NOVA  
WANDMODELL**

Quecksilbergerät von höchster Qualität, ideal für Praxis und Klinik. Nicht schwenkbar. Lichtgrau kunststoffbeschichtete Metallplatte. Glasröhre von höchster Präzision mit Innendurchmesser 4,2 mm +/- 0,2 mm. Gute Ablesbarkeit der eloxierten Skala bis 300 mmHg. Verchromte Metallteile. Quecksilbersicherung. Kunststoffbeschichteter Metallkorb zur optimalen Aufbewahrung des Zubehörs. Spiralschlauch dehnbar bis zu 3 m. Maximale Fehlertoleranz des Gerätes: +/- 3 mmHg. Mit Latexball und verchromtem Ablaßventil. Befestigungsschrauben und Dübel werden mitgeliefert.

**Nr. 03114-00 - Mit Wickelmanschette aus Baumwolle komplett mit Latexpolster 2-Schlauch.**

**Nr. 03114-01 - Mit Hakenmanschette aus Baumwolle komplett mit Latexpolster 2-Schlauch.**

**Nr. 03114-02 - Mit kalibrierter Nylon-Velcromanschette komplett mit Latexpolster 2-Schlauch.**

High quality mercurial sphygmomanometer ideal for use in hospitals and physicians' offices. Non-swiveling metal housing enameled in light gray. Precision glass tube with inside diameter 4,2 mm +/- 0,2 mm. Anodized faceplate with easy-to-read graduated scale. Maximum reading 300 mmHg. Chrome-plated metal parts. Mercury lock. Plastic coated metal basket for convenient accessory storage. Coiled tubing extensible to 3 m. Maximum error throughout range +/- 3 mmHg. With latex bulb and chrome-plated air-release-valve. Mounting hardware included.

**No. 03114-00 - With cotton bandage cuff complete with 2-tube latex bladder.**

**No. 03114-01 - With cotton hook cuff complete with 2-tube latex bladder.**

**No. 03114-02 - With calibrated nylon velcro cuff complete with 2-tube latex bladder.**

Tensiómetro de mercurio de alta calidad y fiabilidad, ideal para consultorios y clínicas. Fijo, no movable. Placa metal recubierta plástico de color gris claro. Tubo vidrio de precisión máxima y diámetro interior de 4,2 mm +/- 0,2 mm. Cómoda lectura de la escala anodizada hasta 300 mmHg. Partes metálicas cromadas. Con cierre de seguridad en el depósito de mercurio. Cestillo metálico recubierto de plástico para la colocación del accesorio. Con tubo espiral extensible hasta 3 metros. Tolerancia de errores máxima del aparato: +/- 3 mmHg. Con pera latex y válvula cromada. Se incluyen tacos y tornillos para la sujeción.

**No. 03114-00 - Con brazaletes de venda de algodón completo con bolsa latex con 2 tubos.**

**No. 03114-01 - Con brazaletes de ganchos de algodón completo con bolsa latex con 2 tubos.**

**No. 03114-02 - Con brazaletes velcro de nilón calibrado completo con bolsa latex con 2 tubos.**

Sfigmomanometro a mercurio di alta qualità, ideale per ospedali ed ambulatori. Corpo dell'apparecchio in metallo, non orientabile, verniciato in grigio chiaro. Colonna di precisione di vetro con diametro interno 4,2 mm +/- 0,2 mm. Quadrante anodizzato con scala graduata di facile lettura. Valore massimo 300 mmHg. Parti metalliche cromate. Chiusura di sicurezza del mercurio. Cestello porta accessori in metallo rivestito di plastica. Tubo a spirale estensibile fino a 3 m. Tolleranza +/- 3 mmHg. Con monopalla in latex e valvola di sfiato cromata. Fornito con accessori di montaggio.

**No. 03114-00 - Con bracciale di cotone a fascia completo di camera d'aria di latex a 2-tubi.**

**No. 03114-01 - Con bracciale di cotone a ganci completo di camera d'aria di latex a 2-tubi.**

**No. 03114-02 - Con bracciale calibrato velcro-nylon completo di camera d'aria di latex a 2-tubi.**



Blutdruckmeßgeräte  
Sphygmomanometer  
Esfigmomanómetros  
Sfigmomanometri



EXACTA-SPEZIAL

Noch modernere Ausführung unseres bisherigen sehr bekannten und beliebten Exacta Manometers. Sehr interessant im Preis. Metallgehäuse, schwarz einbrennlackiert. Mit spezialgehärteter Kupfer-Beryllium Membrane. Keine Nullpunktfixierung. Gut ablesbare Aluminiumskala  $\varnothing$  49 mm bis 300 mmHg. Metallklemme an der Rückseite des Manometers zum Einhängen an der Manschette. Mit Latexball und verchromtem Ablaufventil. In Vinyltasche mit Reißverschluß. Maximale Fehlertoleranz des Gerätes:  $\pm$  3 mm Hg.  
**No. 03120-00 - Mit kalibrierter Nylon-Velcromanschette komplett mit Latexpolster 2-Schlauch.**

Latest version of our well-known Exacta classic sphygmomanometer, with an especially attractive price. Metal housing with baked-on black enamel finish. Special tempered copper-beryllium diaphragm. No stop pin. Easy-to-read graduated aluminium scale 49 mm  $\varnothing$ . Maximum reading 300 mmHg. Clip on rear of manometer for attachment to cuff. With latex bulb and chrome-plated air release valve, in vinyl zipper case. Maximum error  $\pm$  3 mmHg throughout range.  
**No. 03120-00 - With calibrated nylon-velcro cuff complete with 2-tube latex bladder.**

Modelo más moderno que nuestro anterior Exacta manómetro muy popular y conocido. Con precio muy económico. Caja metálica barnizada al fuego de color negro. Con membrana cobreberilio endurecido especial. Sin fijación a cero. Buena lectura de la escala aluminio  $\varnothing$  49 mm hasta 300 mmHg. Con pinza metálica a la parte posterior del manómetro para ganchar en el brazalete. Con pera de latex y válvula cromada. En estuche de vinyl con cierre de cremallera. Tolerancia de errores máxima del aparato:  $\pm$  3 mmHg.  
**No. 03120-00 - Con brazalete velcro de nilón calibrado completo con bolsa de latex con 2 tubos.**

La più recente versione dei famosi sfigmomanometri tradizionali Exacta, ad un prezzo veramente interessante. Realizzato in metallo rifinitura smaltata a forno. Membrana speciale di rame-berillio indurito. Senza fissaggio a zero. Scala graduata in alluminio  $\varnothing$  49 mm di facile lettura. Valore massimo 300 mmHg. Con morsetto nella parte posteriore del manometro per l'attacco al bracciale. Monopalla di latex e valvola di sfiato cromata. Fornito in borsa di vinilpelle con cerniera lampo. Tolleranza  $\pm$  3 mmHg.  
**No. 03120-00 - Con bracciale calibrato velcro-nylon completo di camera d'aria di latex a 2 tubi.**



Blutdruckmeßgeräte  
Sphygmomanometer  
Esfigmomanómetros  
Sfigmomanometri



Sehr preisgünstiges, modernes und beliebtes Einhandmodell. Stabiles Kunststoffgehäuse, schwarz. Spezialgehärteter Kupfer-Beryllium Membrane. Keine Nullpunktfixierung. Gut ablesbare Aluminiumskala  $\varnothing$  63 mm bis 300 mmHg. Löffel aus rostfreiem Stahl. Mit Latexball und verchromtem Ablaufventil. Mit verchromter Schlauchverschraubung auf der rechten Seite unterhalb des Manometers. In Vinyltasche mit Reißverschluss. Maximale Fehlertoleranz des Gerätes:  $\pm$  3 mmHg.

**No. 03122-00 - Mit kalibrierter Nylon-Velcromanschette komplett mit Latexpolster 1-Schlauch.**

Very attractive and economical modern palm-style sphygmomanometer. Black housing of engineering plastic with chrome-plated tube connection at lower right. Special tempered copper-beryllium diaphragm. No stop pin. Easy-to-read graduated aluminium scale  $\varnothing$  63 mm. Maximum reading 300 mmHg. Stainless steel handle. With latex bulb and chrome-plated air release valve, in vinyl zipper case. Maximum error  $\pm$  3 mmHg throughout range.

**No. 03122-00 - With calibrated nylon-velcro cuff complete with 1-tube latex bladder.**

Modelo de mano, muy económico, moderno y popular. Estuche plástico duro de color negro. Con membrana cobre-berilio endurecido especial. Sin fijación a cero. Buena lectura de la escala de aluminio  $\varnothing$  63 mm hasta 300 mmHg. Con cuchara de acero inoxidable. Con pera de latex y válvula cromada. Con atornilladura de tubo cromada al lado derecho debajo del manómetro. En estuche de vinilino con cierre de cremallera. Tolerancia de errores máxima del aparato:  $\pm$  3 mmHg.

**No. 03122-00 - Con brazalete velcro de nilón, calibrado, completo con bolsa de latex con 1 tubo.**

Sfigmomanometro molto elegante, moderno ed economico. Modello a mano. Scatola del manometro in materiale sintetico robusto con uscita laterale cromata per collegamento del tubo (in basso a destra). Membrana speciale in rame-berillio indurito. Senza fissaggio a zero. Scala graduata in alluminio di facile lettura,  $\varnothing$  63 mm. Valore massimo 300 mmHg. Manico in acciaio inossidabile. Con monopalla di latex, valvola di sfiato cromata. Fornito in borsa di vinilpelle con chiusura lampo. Tolleranza  $\pm$  3 mmHg.

**No. 03122-00 - Con bracciale calibrato velcro-nylon completo di camera d'aria di latex add 1 tubo.**

Blutdruckmeßgeräte  
Sphygmomanometer  
Esfigmomanómetros  
Sfigmomanometri



Einhandblutdruckmessgerät, besonders geeignet für Kinderarztpraxen. Wurde speziell in der kinderfreundlichen Farbe blau gestaltet. Verchromtes Metallgehäuse. Spezialgehärtete Kupfer-Beryllium Membrane. Keine Nullpunktfixierung. Gut ablesbare blau-weiße Aluminiumskala  $\varnothing$  49 mm bis 300 mmHg. Löffel aus rostfreiem Stahl. Blauer Weichkunststoffball und verchromtes Ablaufventil. Verchromte Schlauchverschraubung am Manometeroberteil. In blauer Kunstledertasche mit Reißverschluss. Maximale Fehlertoleranz:  $\pm$  3 mmHg. Komplett mit 3 verschiedenen blauen, kalibrierten Nylon-Velcro-Manschetten, mit Latexpolster 1-Schlauch. Alle Manschetten werden mit besonders kinderfreundlichem Bäreindruck geliefert.

**Nr. 03126-00 - Komplettes Set mit 3 austauschbaren Manschetten mit Metallkonnektoren.**  
Neugeborene: 15,5 x 5,0 cm - Säuglinge: 23,0 x 7,2 cm - Kinder: 35,5 x 10,0 cm

Modern palm-model sphygmomanometer specially designed for pediatric use. Interchangeable cuffs equipped with metal tube connectors for quick and reliable attachment to unit of cuff appropriate to age of patient. Scale, bulb, cuffs, and case in attractive light blue color, with cuffs printed with child-friendly bear motif. Chrome-plated metal housing with tube connection at top. Stainless steel handle. Special tempered copper-beryllium diaphragm. No stop pin. Easy-to-read graduated manometer scale  $\varnothing$  49 mm. Maximum reading 300 mmHg. With soft plastic bulb, chrome-plated air-release valve, and set of three interchangeable cuffs, in leatherette zipper case. Maximum error  $\pm$  3 mmHg throughout range.

**No. 03126-00 - Complete with set of three interchangeable cuffs with metal connectors.**  
Newborn: 15,5 x 5,0 cm - Infant: 23,0 x 7,2 cm - Child: 35,5 x 10,0 cm

Tensiómetro a mano, apropiado especialmente p. consultorios de pediatra. Se fabrica en color azul, agradable p. niños. Estuche metálico cromado. Membrana cobre-berilio endurecido especial. Sin fijación a cero. Buena lectura de la escala aluminio de colores azul y blanco  $\varnothing$  49 mm hasta 300 mmHg. Cuchara de acero inoxidable. Pera de hule de plástico suave azul. Válvula cromada. Atornilladura de tubo cromada a la parte superior del manómetro. En estuche de cuero artificial, azul. c. cierre de cremallera. Tolerancia de errores máxima:  $\pm$  3 mmHg. 3 brazaletes velcro de nilón, calibrados, con bolsas latex, 1 tubo de tamanos diferentes de color azul. Los tres brazaletes llevan impreso unos osos especialmente atractivo p. niños.

**No. 03126-00 - Juego, completo con 3 brazaletes intercambiables con conectores metálicos.**  
Recien nacidos: 15,5 x 5,0 cm - Lactantes: 23,0 x 7,2 cm - Niños: 35,5 x 10,0 cm

Sfigmomanometro moderno, modello a mano, per uso pediatrico. Bracciali intercambiabili corredati di connettori di metallo per un veloce e sicuro attacco all'apparecchio del bracciale più adatto all'età del paziente. Scala graduata, monopalla, bracciali e astuccio di colore azzurro. Bracciali con stampato motivo adatto per bambini. Manometro cromato con uscita per collegamento tubo nella parte superiore. Manico in acciaio inossidabile. Membrana speciale in rame-berillio indurito. Senza fissaggio a zero. Scala graduata del manometro  $\varnothing$  49 mm di facile lettura. Valore massimo 300 mmHg. Monopalla in plastica morbido, valvola di sfianto cromata e set di 3 bracciali intercambiabili in astuccio di finta pella con cerniera lampo. Tolleranza  $\pm$  3 mmHg.

**Nr. 03126-00 - Comprende set di 3 bracciali intercambiabili con raccordi di metallo.**  
Neonati: 15,5 x 5,0 cm - Bambini piccoli: 23,0 x 7,2 cm - Bambini: 35,5 x 10,0 cm



Blutdruckmeßgeräte  
Sphygmomanometer  
Esfigmomanómetros  
Sfigmomanometri



MINIMUS II

Weltweit bekanntes und überaus beliebtes Einhandmodell. Verchromtes Metallgehäuse. Spezialgehärtete Kupfer-Beryllium Membrane. Keine Nullpunktfixierung. Gut ablesbare Aluminiumskala  $\varnothing$  49 mm bis 300 mmHg. Löffel aus rostfreiem Stahl. Mit Latexball und verchromtem Abbläventil. Mit verchromter Schlauchverschraubung am Manometeroberteil. In Vinyltasche mit Reißverschluß. Maximale Fehlertoleranz des Gerätes:  $\pm$  3 mmHg.

**Nr. 03132-00 - Mit Wickelmanschette aus Baumwolle komplett mit Latexpolster 1-Schlauch.**

**Nr. 03132-01 - Mit Hakenmanschette aus Baumwolle komplett mit Latexpolster 1-Schlauch.**

**Nr. 03132-02 - Mit kalibrierter Nylon-Velcromanschette komplett mit Latexpolster 1-Schlauch.**

World-famous palm-style aneroid sphygmomanometer. Chrome-plated metal housing. Special tempered copper-beryllium diaphragm. No stop pin. Easy-to-read graduated aluminum scale 49 mm  $\varnothing$ . Maximum reading 300 mmHg. Stainless steel handle. With latex bulb and chrome-plated air release valve. In vinyl zipper case. Maximum error  $\pm$  3 mmHg throughout range.

**No. 03132-00 - With cotton bandage cuff, complete with 1-tube latex bladder.**

**No. 03132-01 - With cotton hook cuff, complete with 1-tube latex bladder.**

**No. 03132-02 - With calibrated nylon-velcro cuff, complete with 1-tube latex bladder.**

Modelo de mano, de fama mundial y preferido por los medicos. Caja metálica cromada donde se aloja el mecanismo. Con membrana cobre-berilio endurecido especial. Sin fijación a cero. Buena lectura de la escala de aluminio  $\varnothing$  49 mm hasta 300 mmHg. Con cuchara de acero inoxidable. Con pera latex y válvula cromada. Con atornilladura de tubo cromada a la parte superior del manómetro. En estuche de vinilio con cierre de cremallera. Tolerancia máxima del aparato:  $\pm$  3 mmHg.

**No. 03132-00 - Con brazalete de venda de algodón completo con bolsa de latex con 2 tubos.**

**No. 03132-01 - Con brazalete de ganchos de algodón completo con bolsa de latex con 2 tubos.**

**No. 03132-02 - Con brazalete velcro de nilón calibrado completo con bolsa de latex con 2 tubos.**

Sfigmomanometro ad aneroido, modello a mano di fama mondiale. Manometro cromato con uscita per collegamento tubo cromata, nella parte superiore. Membrana speciale di rame-berillio indurito. Senza fissaggio a zero. Scala graduata in alluminio  $\varnothing$  49 mm di facile lettura. Valore massimo 300 mmHg. Manico in acciaio inossidabile. Con monopalla di latex e valvola di sfianto cromato. Fornito in borsa vinilpelle con cerniera lampo. Tolleranza  $\pm$  3 mmHg.

**No. 03132-00 - Con bracciale di cotone a fascia completo di camera d'aria latex ad 1 tubo.**

**No. 03132-01 - Con bracciale di cotone a ganci completo di camera d'aria di latex ad 1 tubo.**

**No. 03132-02 - Con bracciale calibrato velcro-nylon completo di camera d'aria di latex ad 1 tubo.**

Blutdruckmeßgeräte  
Sphygmomanometer  
Esfigmomanómetros  
Sfigmomanometri



**MINIMUS III**

Weltweit bekanntes und beliebtes Einhandmodell. Verchromtes Metallgehäuse. Spezialgehärtete Kupfer-Beryllium Membrane. Keine Nullpunktfixierung. Gut ablesbare Aluminiumskala  $\varnothing$  49 mm bis 300 mmHg. Löffel aus rostfreiem Stahl. Latexball und verchromtes Ablaßventil. Zwei verchromte Schlauchverschraubungen an der rechten Seite unterhalb des Manometers. In Vinyltasche mit Reißverschluss. Maximale Fehlertoleranz des Gerätes:  $\pm$  3 mmHg.

**Nr. 03133-00 - Mit Wickelmanschette aus Baumwolle, komplett mit Latexpolster mit Doppelschlauch.**

**Nr. 03133-01 - Mit Hakenmanschette aus Baumwolle, komplett mit Latexpolster mit Doppelschlauch.**

**Nr. 03133-02 - Mit kalibrierter Nylon-Velcromanschette, komplett mit Latexpolster mit Doppelschlauch.**

World-famous and popular palm-style sphygmomanometer. Chrome-plated metal housing with 2 chromed-tube connections at lower right. Special tempered copper-beryllium diaphragm. No stop pin. Easy-to-read graduated aluminium scale  $\varnothing$  49 mm. Maximum reading 300 mmHg. Stainless steel handle. With latex bulb and chrome-plated air release valve. In vinyl zipper case. Maximum error  $\pm$  3 mmHg throughout range.

**No. 03133-00 - With cotton bandage cuff, complete with double-tube latex bladder.**

**No. 03133-01 - With cotton hook cuff, complete with double-tube latex bladder.**

**No. 03133-02 - With calibrated nylon velcro cuff complete with double-tube latex bladder.**

Modelo de mano, conocido en el mundo entero y de gran aceptación. Caja metálica cromada donde se aloja el mecanismo. Membrana cobre-berilio endurecido especial. Sin fijación a cero. Buena lectura de la escala aluminio  $\varnothing$  49 mm hasta 300 mmHg. Cuchara de acero inoxidable. Pera latex y válvula cromada. Dos atornilladuras de tubo cromadas al lado derecho debajo del manómetro. En estuche vinílico con cierre de cremallera. Tolerancia de errores máxima:  $\pm$  3 mmHg.

**No. 03133-00 - Con brazalete de venda de algodón, completo con bolsa de latex doble tubos.**

**No. 03133-01 - Con brazalete de ganchos de algodón, completo con bolsa de latex doble tubos.**

**No. 03133-02 - Con brazalete velcro de nilón calibrado, completo con bolsa de latex doble tubos.**

Sfigmomanometro ad aneroide di fama mondiale. Manometro in metallo cromato con uscita cromata laterale (in basso a destra) per collegamento a due tubi. Membrana speciale di rame-berillio indurito. Senza fissaggio a zero. Scala graduata in alluminio  $\varnothing$  49 mm di facile lettura. Valore massimo 300 mmHg. Manico in acciaio inossidabile. Con monopalla di latex e valvola di sfiato cromata. Fornito in borsa vinilpelle con cerniera lampo. Tolleranza  $\pm$  3 mmHg.

**No. 03133-00 - Con bracciale di cotone a fascia, completo di camera d'aria di latex a 2 tubi.**

**No. 03133-01 - Con bracciale di cotone a ganci, completo di camera d'aria di latex a 2 tubi.**

**No. 03133-02 - Con bracciale calibrato velcro-nylon completo di camera d'aria a 2 tubi.**

Diagnostik-Bestecke mit Standardbeleuchtung  
 Diagnostic Sets with Standard illumination  
 Estuches de diagnóstico con iluminación standard  
 Combinazioni per diagnostica con illuminazione standard



**Nr. 03161-00**

Weltbekanntes und preiswertes Otoskop mit Standardbeleuchtung 2,5 V. Besonders geeignet für Studenten und Ärzte.  
Set bestehend: Aus **Otoskopkopf** verchromt, mit Steckverschluss. **Verchromter Batteriegriff 28 mm ø** für 2 Batterien Typ C. Mit abnehmbarem Abdeckglas in Kunststoff-Fassung mit Plastikconnector für den pneumatischen Test. Die verchromte Schwenklinse ist abnehmbar und vergrößert 4,0-fach. Die Lichtstärke kann anhand des Rheostates reguliert werden. Mit 3 wiederverwendbaren Ohrtrichtern 2, 3 und 4 mm ø. Komplet in silberfarbener Kunststofftasche.

**No. 03161-00**

World famous otoscope set at a budget price for physicians and students. 2,5 V standard illumination for use with 2 batteries type C.  
Set includes: **Otoscope head** with pin contact fitting. Chrome-plated. Fixed protective lens in plastic mount may be removed for introduction of instruments. Plastic connector for pneumatic otoscopy. Removable swivel-mounted 4 x magnifier. 2, 3 and 4 mm reusable specula included. **Battery handle 28 mm ø** for 2 C-cell batteries. Chrome-plated. With thumb wheel for securing pin contact heads. With rheostat for adjustment of illumination. Complete in silver-colored plastic pouch.

**No. 03161-00**

Otoscopio muy popular y económico con iluminación standard 2,5 V apropiado para estudiantes y médicos, de fama mundial.  
**Cabeza otoscopio cromada**, con cierre de tornillo. **Mango a pilas cromado 28 mm ø** para dos pilas tipo C. Con cristal de cubierto desmontable en armadura plástica. Con conector plástico para el test neumático. La lente giratoria es desmontable y amplifica 4,0 veces mas. La intensidad de la luz es regulable con el reostato. Con tres espejuelos reutilizables 2, 3 y 4 mm ø. Completo en bolsa de plástico de color gris plata.

**No. 03161-00**

Combinazione otoscopio molto conosciuta, ad un prezzo economico, per ambulatori e studenti. Illuminazione standard 2,5 V con 2 batterie tipo C.  
La combinazione comprende: **Testa otoscopio** con chiusura a vite. Cromata. La lente di protezione fissa in supporto di plastica può essere tolta per l'inserimento di strumenti. Connettore di plastica per test pneumatico. Lente d'ingrandimento 4 x in montatura girevole estraibile. Inclusi specoli riusabili da 2, 3 e 4 mm. **Manico a pila ø 28 mm** per 2 batterie tipo C. Cromato. Con ruota ad orlo zigrinato per fissare la testa dell'otoscopio con chiusura a vite. Con reostato per la regolazione dell'illuminazione. Fornito in busta di plastica colore grigio argento.

Diagnostik-Bestecke mit Standardbeleuchtung  
 Diagnostic Sets with Standard illumination  
 Estuches de diagnóstico con iluminación standard  
 Combinazioni per diagnostica con illuminazione standard



UNI II

**Nr. 03161-01**

Weltbekanntes und preisgünstiges **May-Ophthalmoskop**: mit Standardbeleuchtung 2,5 V. Besonders für Studenten und Ärzte geeignet. Ophthalmoskop mit Steckverschluß. Anhand des Linsenrades können Korrekturlinsen von 0 bis +20 und 0 bis -20 Dioptrien gewählt werden. Mit einer Blende: großer Kreis. Mit verchromtem **Batteriegriff**: 28 mm  $\phi$  für 2 Batterien Typ C. Die Lichtstärke kann anhand des Rheostates reguliert werden. Komplett in silbergrauer Kunststofftasche.

**No. 03161-01**

World-famous ophthalmoscope set at a budget price for physicians and students. 2,5 V standard illumination for use with 2 batteries Type C. Set includes: **May ophthalmoscope head**: Pin contact fitting. Lens selection wheel permits choice of corrective lenses from 0 to +20 and 0 to -20 diopters. Single large circle aperture. **Battery handle**: 28 mm  $\phi$  for 2 C-cell batteries. Chrome-plated. With thumb wheel for securing pin-contact heads. Rheostat for adjustment of illumination. Complete in silver-gray plastic pouch.

**No. 03161-01**

**Oftalmoscopio May**: muy popular y económico con iluminación standard 2,5 V, apropiado para estudiantes y médicos de fama mundial. Oftalmoscopio con cierre de tornillo. Con ayuda de la rueda de lentes se puede elegir lentes de corrección de 0 a +20 y 0 a -20 dioptrías. Y con una apertura: gran círculo. Con **mango a pilas**: cromado 28 mm  $\phi$  para dos pilas tipo C. La intensidad de la luz es regulable con el reostato. Completo en bolsa de plástico de color gris plata.

**No. 03161-01**

Combinazione oftalmoscopio molto conosciuta, a prezzo economico, per ambulatori e studenti. Illuminazione standard 2,5 V con 2 batterie tipo C. La combinazione comprende: **Oftalmoscopio di May**: Con chiusura a vite. La rotella di selezione delle lenti permette la scelta di lenti di correzione da 0 a +20 e da 0 a -20 diottrie. Apertura singola a cerchio grande. **Manico a pila**:  $\phi$  28 mm per 2 batterie tipo C. Cromato. Con ruota ad orlo zigrinato per fissare la testa dell'otoscopio con chiusura a vite. Reostato per la regolazione dell'illuminazione. Fornito con busta di plastica di colore grigio argento.

Diagnostik-Bestecke mit Standardbeleuchtung  
 Diagnostic Sets with Standard illumination  
 Estuches de diagnóstico con iluminación standard  
 Combinazioni per diagnostica con illuminazione standard



**Nr. 03161-02**

Weltbekanntes diagnostisches Besteck mit Standardbeleuchtung 2,5 V. Äußerst beliebt und sehr preiswert. Besonders geeignet für Studenten und Ärzte. Das Set besteht aus folgenden Teilen: **Otoskopkopf** verchromt, mit Steckverschluß. Abnehmbares Abdeckglas in Kunststofffassung, mit Plastikconnector für pneumatischen Test. Abnehmbarer Schwenklinse (Vergrößerung 4,0-fach). 3 wiederverwendbaren Ohrtrichtern 2, 3 und 4 mm ø. **May-Ophthalmoskop** mit Steckverschluß. Anhand des Linsenrades können Korrekturlinsen von 0 bis +20 und 0 bis -20 Dioptrien gewählt werden. Mit einer Blende: großer Kreis. **Batteriegriff** verchromt, 28 mm ø für 2 Batterien Typ C. Die Lichtstärke kann anhand des Rheostates am Batteriegriff reguliert werden. Alle Teile komplett in silbergrauer Kunststofftasche.

**No. 03161-02**

World-famous otoscope/ophthalmoscope diagnostic set at a budget price for physicians and students. 2,5 V Standard illumination for use with 2 batteries type C. Set includes: **Otoscope head** - Pin contact fitting. Chrome-plated. Fixed protective lens in plastic mount may be removed for introduction of instruments. Plastic connector for pneumatic otoscopy. Removable swivel-mounted 4 x magnifier. 2, 3 and 4 mm reusable specula included. **May ophthalmoscope head**. Pin contact fitting. Lens selection wheel permits choice of corrective lenses from 0 to +20 and 0 to -20 diopters. Single large circle aperture. **Battery handle**. 28 mm ø for 2 C-cell batteries. Chrome-plated. With thumb wheel for securing pin-contact heads. Rheostat for adjustment of illumination.

**No. 03161-02**

Este estuche de diagnóstico con iluminación standard 2,5 V es muy popular y muy económico, apropiado para estudiantes y médicos. Juego, compuesto de: **Cabeza otoscopio** cromado, con cierre de tornillo. Con cristal de cubierto en armadura plástica, con conector plástico para el test neumático. Con lente giratorio desmontable (amplificación: 4 veces más). **Cabeza oftalmoscopio May** con cierre de tornillo. Con ayuda de la rueda de lentes se puede elegir lentes de corrección de 0 a +20 y 0 a -20 dioptrías. Con una apertura: gran círculo. **Mango a pilas** cromado, 28 mm ø para dos pilas tipo C. La intensidad de la luz es regulable con el reostato al tope del mango. Todos los partes se presentan en una bolsa plástica de color gris plata.

**No. 03161-02**

Combinazione per diagnostica otoscopio/oftalmoscopio a prezzo economico, per ambulatori e studenti. Illuminazione standard 2,5 V con 2 batterie tipo C. La combinazione comprende: **Testa otoscopio** - Chiusura a vite. Cromata. La lente di protezione fissa in supporto di plastica può essere tolta per l'inserimento di strumenti. Connettore di plastica per test pneumatico. Lente d'ingrandimento 4 x in montatura girevole estraibile. Inclusi specoli da 2, 3 e 4 mm riusabili. **Oftalmoscopio May**. Chiusura a vite. La rotella di selezione permette la scelta di lenti di correzione da 0 a +20 e da 0 a -20 diottrie. Apertura singola a cerchio grande. **Manico a pila** ø 28 mm con 2 batterie tipo C. Cromato. Con ruota ad orlo zigrinato per fissare la testa dell'otoscopio con chiusura a vite. Reostato per la regolazione dell'illuminazione. Fornita in busta di plastica colore grigio argento.



Diagnostik-Bestecke mit Standardbeleuchtung  
 Diagnostic Sets with Standard illumination  
 Estuches de diagnóstico con iluminación standard  
 Combinazioni per diagnostica con illuminazione standard



### ECO "T" 03161-03T

- a) Otoskop, mit Schraubverschluss und 3 Ohrtrichtern, 2-3-4 mm  
 Otoscope with screw fitting and 3 ear speculas with, 2-3-4 mm  
 Otopscopio, con cierre a tornillo y con 3 espéculos auriculares de 2-3-4 mms  
 Testa otoscopio: chiusura a vite, connettore di plastica per test pneumatico,  
 3 specoli (2, 3 e 4 mm) riutilizzabili, lente di protezione da togliere
- b) Ophthalmoskop, 0 bis +20 und 0 bis -20 Dioptrien, mit Schraubverschluss  
 Ophthalmoscope from 0 to +20 and 0 to -20 dioptres with screw fitting  
 Oftalmoscopio, 0 a + 20 y 0 a - 20 dioptrías, con cierre a tornillo  
 Testa oftalmoscopio: chiusura a vite, lenti di correzione da 0 a +20 e da 0 a -20 diottrie.
- c) Nasenspekulum  
 Nasal Speculum  
 Espéculo nasal  
 Specoli nasali divaricabili
- d) Lampenträger mit Schraubverschluss  
 Bent arm illuminator with screw fitting  
 Porta-lámpara, con cierre a tornillo  
 Porta lampada con 2 specchi laringei, misura 3 e 4.
- e) 2 Kehlkopfspiegel No. 3 und 4  
 2 laryngeal mirrors no. 3 and 4  
 Espejos laringeos Nos. 3 y 4  
 Porta lampada con 2 specchi laringei, misura 3 e 4.
- f) Mundspatelhalter  
 Tongue blade holder  
 Abaja-lenguas  
 Porta abbassa-lingua
- g) Batteriegriff für 2 Batterien mit Schraubverschluss (ohne Batterien)  
 Battery handle for 2 batteries  
 Mango para 2 pilas, con cierre a tornillo (sin pilas)  
 Manico a pila (senza pila), illuminazione regolabile
- h) Ersatzlämpchen 2.5 V  
 Spare lamp 2.5 V  
 Bombillo de repuesto 2.5 V  
 Lampadina di ricambio

### ECO "C" 03161-03C

Inhalt gleich wie oben, mit drehbarem Schnellverschluss.  
 Contents same as above, but with quick plug-in connector.  
 Mismo contenido como arriba pero con CIERRE RAPIDO GIRATORIO.  
 Lo stesso contenuto come sopra ma con chiusura a baionetta.

Diagnostik-Bestecke mit Xenonbeleuchtung  
 Diagnostic Sets with Xenon illumination  
 Estuches de diagnóstico con iluminación Xenon  
 Combinazioni per diagnostica con illuminazione Xenon



Kleine, sehr moderne Qualitätsinstrumente aus Kunststoff, grau, mit Xenonbeleuchtung XL 2.5 V. Sehr preiswert und aufgrund der Größe besonders gut für die Arzttasche geeignet. Schraubverschluss. **Otoskop:** Fiber-Optik. Anschluß für pneumatischen Test. Lupe vergrößert 2,5-fach. Batteriegriff für 2 Batterien Typ AA. **Ophthalmoskop:** Korrekturlinsen: 0 bis +20 und 0 bis -20 Dioptrien. Blenden: Kreis groß + klein, Halbkreis, Fixierstern und Grünfilter. Griff für 2 Batterien Typ AA. Das Otoskop- und das Otoskop/Ophthalmoskop-Besteck werden jeweils mit einem Metallkonnector für pneumatischen Test und Plastikröhrchen mit jeweils 5 wiederverwendbaren Ohrtrichtern 2,5 und 4,0 mm geliefert. Komplet in modernem schwarzen Kunststoffetui.

**Nr. 03171-00 - Otoskop mit Griff AA.**

**Nr. 03171-01 - Ophthalmoskop mit Griff AA.**

**Nr. 03171-02 - Otoskop/Ophthalmoskop jeweils mit Griff AA.**

Economically priced state-of-the-art quality instrument made of plastics, gray color, with Xenon illumination XL 2.5 V. Due to its small size it is most suitable for each practitioner's bag. **Otoscope:** Fiber optic. Screw type fitting. 2.5 x magnifying glass. Battery handle for 2 AA-cell batteries. **Ophthalmoscope:** Corrective lenses ranging from 0 to +20 and 0 to -20 diopters. Apertures: large and small circle, semi-circle, fixation star and green filter. Otoscope and otoscope/ophthalmoscope set each contain a metal connector for pneumatic otoscopy as well as plastic tube with 5 each reusable ear specula 2,5 and 4,0 mm. All sets come in modern black plastic case.

**No. 03171-00 - Otoloscope with AA-handle.**

**No. 03171-01 - Ophthalmoscope with AA-handle.**

**No. 03171-02 - Otoloscope/ophthalmoscope with 1 each AA-handle.**

Instrumentos de calidad, muy moderno y pequeño de plástico resistente, gris, con iluminación Xenon XL 2.5 V. Muy económico y gracias al tamaño apropiado para el bolsillo del médico. Cierre roscado. **Otoscopio:** fibra óptica. Conexión para test neumático. Lupa aumenta 2,5 veces más. Mango a pilas para 2 pilas, tipo AA. **Oftalmoscopio:** Lentes de corrección: 0 hasta +20 y o hasta -20 dioptrías. Aberturas: círculo grande y pequeño, semicírculo, estrella fijadora y filtro verde. Con mango para 2 pilas, tipo AA. Juego de otoscopio y de otoscopio/oftalmoscopio con conector metálico para el test neumático y con 5 espejuelos reutilizables de 2,5 y 4,0 mm en tubito de plástico. Todos los juegos se presentan en estuche de plástico negro moderno.

**No. 03171-00 - Otoscopio con mango AA.**

**No. 03171-01 - Oftalmoscopio con mango AA.**

**No. 03171-02 - Oto/oftalmoscopio con mangos AA.**

Strumento piccolo, moderno, di alta qualità realizzato in plastica, grigio, con illuminazione Xenon XL 2.5 V. Molto economico e, date le sue dimensioni, il più adatto a stare nella borsa del medico. **Otoscopio:** con attacco a vite. Lente d'ingrandimento 2,5X. Manico a pila per 2 batterie tipo AA. **Oftalmoscopio:** Lenti correttive da 0 a +20 e da 0 a -20 diottrie. Aperture: a cerchio grande e piccolo, semicerchio, a stella, filtro verde. Con manico per 2 batterie tipo AA. L'otoscopio e la combinazione otoscopio/oftalmoscopio hanno un connettore per test pneumatico e tubo di plastica con 5 specoli auricolari 2,5 e 4,0 mm. cad. Tutte le combinazioni sono fornite in un moderno astuccio di plastica nera.

**No. 03171-00 - Otoscopio con manico AA.**

**No. 03171-01 - Oftalmoscopio con manico AA.**

**No. 03171-02 - Oto/Oftalmoscopio con manici AA.**







Nystagmusbrille  
 Nystagmus spectacles  
 Anteojos para nistagmo  
 Occhiali nistagmo



### FRENZEL

03167-03  
 Beleuchtete Nystagmusbrille  
 mit querliegendem Batterie-  
 handgriff und festen Gläsern

Energiequelle:  
 2 Stück 4-Volt-Lämpchen  
 2 Stück Baby-Zellen 1.5 V

03167-03  
 Anteojos para nistagmo, con  
 iluminación, con mango para  
 pilas en forma horizontal,  
 vidrios fijos,

Alimentación:  
 2 unidades de bombillos de  
 4 voltios  
 2 unidades de pilas de  
 1.5 voltios

03167-03  
 Nystagmus spectacles for  
 observation of the eyes during  
 examination of the vestibular  
 apparatus, with battery handle  
 and fixed glasses. Illuminated  
 on inside of lenses.

Source of energy:  
 2 bulbs 4-volt  
 2 baby-battery cells 1.5 V

03167-03  
 Occhiali Nistagmo illuminati  
 con manopolo a batteria,  
 lenti fisse.  
 Per la rilevazione della reazione  
 patologica del nistagmo.

Alimentazione:  
 2 lampadine 4 Volt  
 2 batterie 1,5 Volt

Stirnspiegel  
Head Mirror  
Espejos frontales  
Specchi frontali



03180-93  
ø 90 mm



ZIEGLER  
03180-90  
compl.



03180-92

03180-90  
Ziegler-Stirnspiegel,  
komplett, mit schwarzem  
Stirnreifen,  
mit Kugelgelenk,  
90 mm ø

03180-90  
Ziegler Head Mirror,  
complete with black head  
band, with ball socket,  
90 mm ø

03180-90  
Ziegler espejo frontal, com-  
pleto con cinta negra,  
con articulación,  
90 mm ø

03180-90  
Specchio frontale, Ziegler,  
completo con fascia nera,  
con snodo sferico,  
90 mm di ø

03180-92  
Stirnreifen, allein

03180-92  
head band, only

03180-92  
cinta, suelta

03180-92  
fascia, sola

03180-93  
Spiegel, allein  
90 mm ø

03180-93  
Mirror, only  
90 mm ø

03180-93  
Espejo, suelto  
90 mm ø

03180-93  
Specchio,  
solo 90 mm ø

Stirnlampe  
Head Light  
Lámpara frontal  
Lampada frontale



CLAR  
03195-00

komplett mit Stirnstreifen und Kabel  
complete with head band and cable  
completo con cinta frontal y cable  
completa con fascia frontale e cordone



03195-01  
ø 55 mm

Spiegel aus Glas ohne Fassung  
Glass Mirror without frame  
Reflector de cristal, sin montura  
Riflettore di cristallo, senza montatura



03195-06  
6 Volt



03195-07 Kleintransformator  
220 Volt = 0 - 10 Volt / 3 Watt  
Mini-Transformer Unit  
Transformador eléctrico pequeño  
Mini-trasformatore elettrico

03195-08 Kleintransformator  
110 Volt = 0 - 10 Volt / 3 Watt  
Mini-Transformer Unit  
Transformador eléctrico pequeño  
Mini-trasformatore elettrico

03195-09 CLAR-Spiegel-Gelenkverbindung  
CLAR special socket joint  
Articulación especial de CLAR  
Snodo speciale di CLAR

03195-04 Stirnstreifen, alleine  
head band, only  
cinta frontal, suelta  
fascia frontale, sola

03195-10 CLAR Kopfspange allein aus  
Metall mit Kabelaschen und  
Fixierschraube mit Gelenk  
CLAR spring metal head band  
only, with cable clips and fixing  
screw with socket joint  
Casco frontal de resorte metálico  
suelto de CLAR, con bridas de  
cable, y tornillo de sujeción con  
articulación  
Fascia metallica a casco di CLAR,  
solo, con portacordoni e vite di  
fissaggio a snodo

Stethoskope  
Stethoscopes  
Estetoscopios  
Stetoscopi

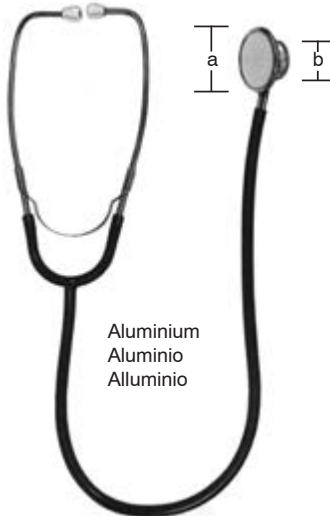

Aluminium  
Aluminio  
Alluminio

DUPLEX



Aluminium  
Aluminio  
Alluminio

ANESTOPHON  
03248-00

	a	b	
03246-00	48 mm, 1.9"	30 mm, 1.2"	
03246-01	39 mm, 1.5"	25 mm, 1.0"	Baby
03246-02	21 mm, 0.8"	21 mm, 0.8"	Neonatal



PINARD  
03260-15 15 cm, 6"  
ALU



PINARD  
03262-18 18 cm, 7"  
Holz, wood, madera, legno

Perkussionshämmer  
Percussion Hammers  
Martillos de percusión  
Martelli da percussione



TAYLOR - USA Mod.  
03288-17 17 cm, 6 <sup>3</sup>/<sub>4</sub>"  
03288-20 20 cm, 8"



BABINSKY  
03292-22 22 cm, 8 <sup>3</sup>/<sub>4</sub>"

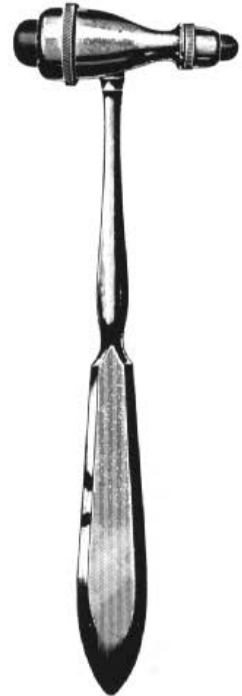

TROEMNER  
03294-24 24 cm, 9 <sup>1</sup>/<sub>2</sub>"



DEJERINE  
03304-20 20 cm, 8"



BERLINER  
03306-17 17 cm, 6 <sup>3</sup>/<sub>4</sub>"

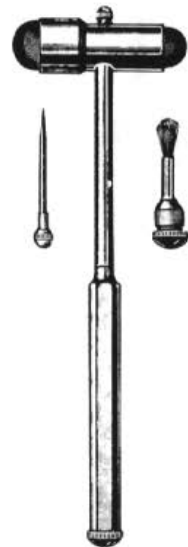

BUCK  
03308-18 18 cm, 7"

Prüf- und Meßinstrumente  
 Examination and Measuring Instruments  
 Instrumentos para exámenes y medidas  
 Strumenti per esaminare e misurare

Dynamometer  
 Dynamometer  
 Dinamómetro  
 Dinamometro

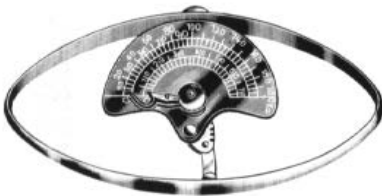

COLLIN  
 03310-01 Erwachsene, Adult,  
 adultos, adulti  
 03310-02 Kind, child, niños, bambini

Winkelmesser  
 Goniometer  
 Goniómetro  
 Goniometro



MOELTGEN  
 03312-01

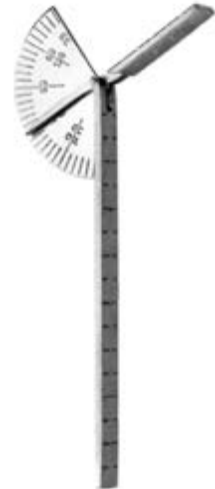

Finger-Goniometer  
 Finger goniometer  
 Goniómetro para dedos  
 Goniometro per le dita  
 03314-01



WARTENBERG  
 03320-19 19 cm, 7 1/2"



Wachstuchbandmaß  
 Tape Measure, oil cloth  
 Cinta métrica, tela encerada  
 Metro a nastro in tela cerata

03350-15 1,8 m

mm / Inch

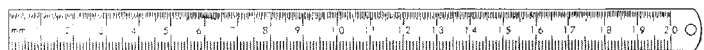

Metall

03340-10	10 cm	4"
03340-15	15 cm	6"
03340-20	20 cm	8"
03340-30	30 cm	12"
03340-50	50 cm	20"

Schieblehren  
Calipers  
Calibres  
Calibro

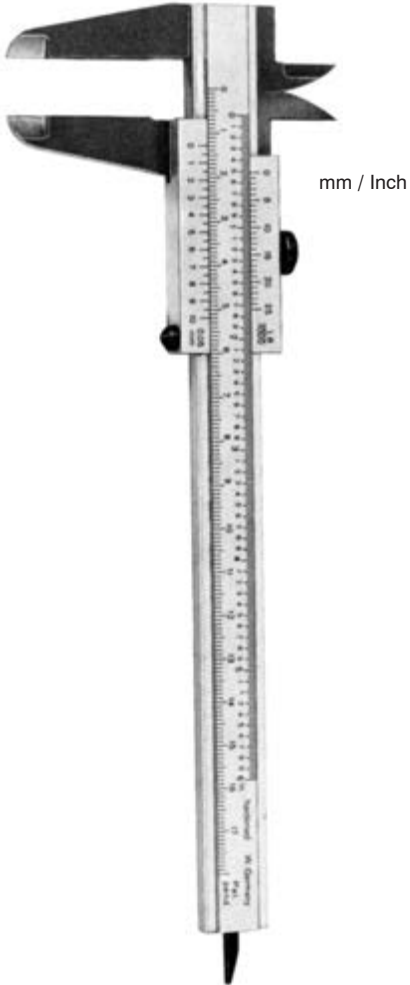

03360-21  
21 cm, 8 1/4"

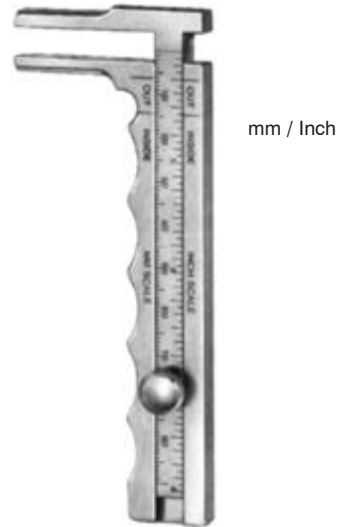

TOWNLEY  
03361-10  
11,5 cm, 4 1/2"



Saugrohre  
Suction tubes  
Tubos de aspiración  
Cannule per aspirazione



POOLE 20 cm, 8"  
05130-05 5.5 mm ø, 0.2"  
(17 Fr.)

05130-10 10 mm ø, 0.4"  
(30 Fr.)



POOLE 19 cm, 7 1/2"  
05140-05 5.5 mm ø, 0.2"  
(17 Fr.)

05140-08 8 mm ø, 0.3"  
(23 Fr.)



BABY-YANKAUER, compl.  
05150-21 21 cm, 8 1/4"

YANKAUER, compl.  
05150-27 27 cm, 10 1/2"

Kathetereinführzangen, Saugrohre  
 Catheter Introducing Forceps, Suction tubes  
 Pinzas para catéteres, Tubos de aspiración  
 Pinze per introdurre le sonde, Cannule per aspirazione

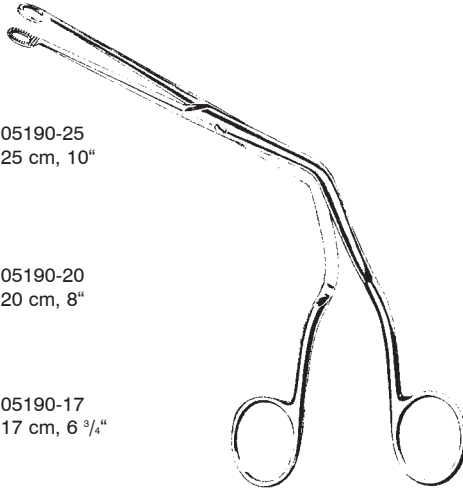
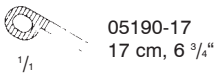
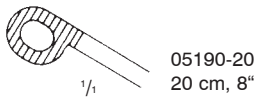
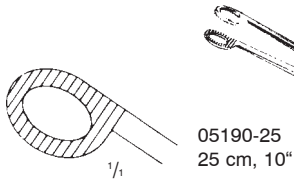

MAGILL



ANDREW-PYNCHON  
 05170-24  
 6 mm ø, 1/2"  
 24 cm, 9 1/2"



COOLEY  
 05160-02  
 8 mm ø, 0.3"  
 36 cm, 14 1/4"



COOLEY  
 05160-03  
 8 mm ø, 0.3"  
 30 cm, 11 3/4"



DE BAKEY  
 05160-04  
 3 mm ø, 0.1"  
 27 cm, 10 1/2"

Laryngoskope  
Laryngoscopes  
Laringoscopios  
Laringoscopi



McINTOSH

Fig. 0	5,5 cm	2 1/4"	05210-00
Fig. 1	7,5 cm	3"	05210-01
Fig. 2	9,0 cm	3 1/2"	05210-02
Fig. 3	11,0 cm	4 3/8"	05210-03
Fig. 4	13,5 cm	5 1/4"	05210-04

Cold light  
05211-00  
05211-01  
05211-02  
05211-03  
05211-04



05239-03  
Halogen-Lampe  
Halogen Lamp  
Lámpara Halógena  
Lampada Alogena



05239-01  
f./p. Fig. 0-1



05239-02  
f./p. Fig. 2-4



FOREGGER

Fig. 0	5,5 cm	2 1/4"	05220-00
Fig. 1	7,0 cm	2 3/4"	05220-01
Fig. 2	9,0 cm	3 1/2"	05220-02
Fig. 3	11,0 cm	4 3/8"	05220-03
Fig. 4	13,5 cm	5 1/4"	05220-04

Cold light  
05221-00  
05221-01  
05221-02  
05221-03  
05221-04



05239-03  
Halogen-Lampe  
Halogen Lamp  
Lámpara Halógena  
Lampada Alogena



05239-01  
f./p. Fig. 0-1



05239-02  
f./p. Fig. 2-4

Laryngoskope  
Laryngoscopes  
Laringoscopios  
Laringoscopi

## MILLER



05230-00  
55 mm, 2 1/2"  
Nutzlänge  
working length  
largo útil  
lunghezza utile

für Säuglinge  
for babies  
para neonatales  
per neonati



05230-01  
80 mm, 3 1/8"  
Nutzlänge  
working length  
largo útil  
lunghezza utile

für Kinder  
for children  
para niños  
per bambini

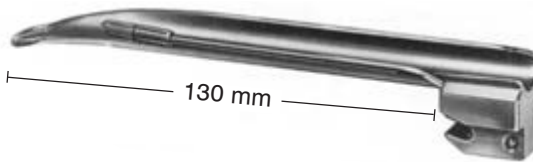

05230-02  
130 mm, 5"  
Nutzlänge  
working length  
largo útil  
lunghezza utile

für Jugendliche  
for adolescents  
para adolescentes  
per adolescenti

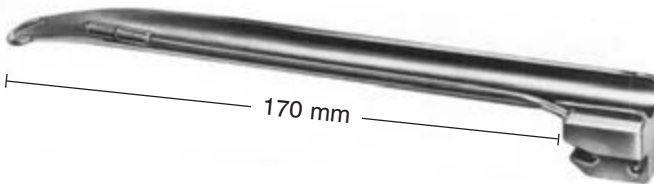

05230-03  
170 mm, 6 3/4"  
Nutzlänge  
working length  
largo útil  
lunghezza utile

für Frauen  
for women  
para mujeres  
per donne



05230-04  
180 mm, 7"  
Nutzlänge  
working length  
largo útil  
lunghezza utile

für Männer  
for men  
para hombres  
per uomini



05239-01  
f./p. Fig. 0-1



05239-02  
f./p. Fig. 2-4

Laryngoskope  
Laryngoscopes  
Laringoscopios  
Laringoscopi



McINTOSH

05203-00

Set bestehend aus:  
1 Etui  
1 Batteriegriff 05234-28  
3 Spatel (Fg. 1-3)

Set consisting of:  
1 Case  
1 Handle  
3 Blades (Fg. 1-3)

Juego compuesto de:  
1 Estuche  
1 Mango  
3 Hoja (Fg. 1-3)

Set composto da:  
1 Astuccio  
1 Manico  
3 Spatole (Fg. 1-3)

05204-00

Set bestehend aus:  
1 Etui  
1 Batteriegriff 05234-28  
4 Spatel (Fg. 1-4)

Set consisting of:  
1 Case  
1 Handle  
4 Blades (Fg. 1-4)

Juego compuesto de:  
1 Estuche  
1 Mango  
4 Hoja (Fg. 1-4)

Set composto da:  
1 Astuccio  
1 Manico  
4 Spatole (Fg. 1-4)



FOREGGER

05223-00

Set bestehend aus:  
1 Etui  
1 Batteriegriff 05234-28  
3 Spatel (Fg. 2-4)

Set consisting of:  
1 Case  
1 Handle  
3 Blades (Fg. 2-4)

Juego compuesto de:  
1 Estuche  
1 Mango  
3 Hoja (Fg. 2-4)

Set composto da:  
1 Astuccio  
1 Manico  
3 Spatole (Fg. 2-4)

05224-00

Set bestehend aus:  
1 Etui  
1 Batteriegriff 05234-28  
4 Spatel (Fg. 1-4)

Set consisting of:  
1 Case  
1 Handle  
4 Blades (Fg. 1-4)

Juego compuesto de:  
1 Estuche  
1 Mango  
4 Hoja (Fg. 1-4)

Set composto da:  
1 Astuccio  
1 Manico  
4 Spatole (Fg. 1-4)

Batteriegriffe, Warmlicht  
Battery handles, warm light  
Mango de pila, luz caliente  
Manico a batteria, luce calda



05233-18 18 mm  $\varnothing$ ,  $\frac{3}{4}$ "



05234-28 28 mm  $\varnothing$ , 1"  
05234-37 37 mm  $\varnothing$ , 1  $\frac{1}{2}$ "



05238-01 30 mm  $\varnothing$ , 1  $\frac{1}{4}$ "

Batteriegriffe, Kaltlicht  
Battery handles, cold light  
Mango de pila, luz fria  
Manico a batteria per luce fredda



05238-02  
18 mm  $\varnothing$   
 $\frac{3}{4}$ "



05238-03  
30 mm  $\varnothing$   
 $1 \frac{1}{4}$ "

Batteriegriffe, Warmlicht  
 Battery handles, warm light  
 Mango de pila, luz caliente  
 Manico a batteria, luce calda



05240-30 30 mm  $\varnothing$ , 1 1/4"  
 Griff mit Trafo-Anschluß  
 Handle with Transformer-connection  
 Mango con conexión al transformador  
 Manico con connessione al trasformatore



05241-11 Trafo 120 V  
 05241-22 Trafo 230 V

Trafo 120 Volt mit amerikanischem Netzanschluß  
 Transformer 120 Volt with american mains connection  
 Transformador 120 V con conexión americana  
 Trasformatore 120 V ricarica batteria

Trafo 230 Volt mit 1,40 m (55") langem Kabel  
 Transformer 230 Volt with cable 1,40 m (55") long  
 Transformador, 230 V con cable de 1,40 m (55")  
 Trasformatore 230 V ricarica batteria



Laryngoskope  
Laryngoscopes  
Laringoscopios  
Laringoscopi

Operation Laryngoskop:  
rostfreier Edelstahl  
Rohr: innen matt/außen glänzend  
Griff: ganz matt

Operation Laryngoscope:  
stainless steel  
tube: inner surface matt/outer  
surface polished  
handle: matt

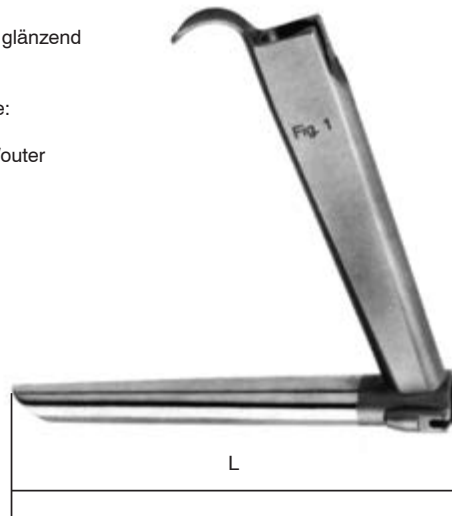

Laringoscopio para operaciones:  
Acero inoxidable  
Pala: Superficie interior: Mate  
Superficie exterior: Brillante  
Mango entero: Mate

Laringoscopio a luce  
fredda per microchirurgia  
endolaringeo  
tubo: interiore opaco – esterno lucido  
manico: opaco

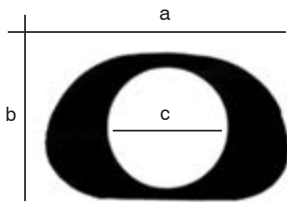

Nr.	L (mm)	a (mm)	b (mm)	c (mm)	Lichtträger light guide Portador de luz portatore di luce
05301-01	135	21,8	14,0	13,0	05302-01
05301-02	152	22,5	14,8	13,0	05302-01
05301-03	182	23,0	15,0	14,0	05302-02
05301-04	172	29,5	18,0	17,0	05302-02
05301-05	172	31,5	21,5	19,0	05302-02

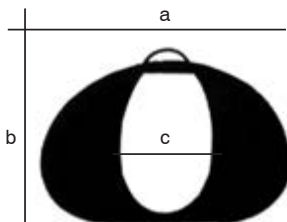

Nr.	L (mm)	a (mm)	b (mm)	c (mm)	Lichtträger light guide Portador de luz portatore di luce
05301-06	182	29,0	20,0	16,0 x 26,0	05302-02
05301-07	222	29,0	20,0	16,0 x 26,0	05302-03

Laryngoskope  
Laryngoscopes  
Laringoscopios  
Laringoscopi

05300-01/02 Bruststütze für Erwachsene/Kinder bestehend aus:  
05300-03 Stützstange für Erwachsene 34 cm / 05300-06 Ring / 05300-05 Gelenk  
05300-04 Stützstange für Kinder 24 cm / 05300-06 Ring / 05300-05 Gelenk  
05300-01/02 Chest Support for adults/children complete consisting of:  
05300-03 Support rod for adults 34 cm / 05300-06 Ring / 05300-05 Joint  
05300-04 Support rod for children 24 cm / 05300-06 Ring / 05300-05 Joint  
05300-01/02 Soporte pectoral para adultos/niños compuesto de:  
05300-03 para adultos 34 cm / 05300-06 / 05300-05  
05300-04 para niños 24 cm / 05300-06 / 05300-05  
05300-01/02 Braccio portalarinoscopio sternale per adulti/bambini composto da:  
05300-03 per adulti 34 cm / 05300-06 anello / 05300-05 giunto  
05300-04 per bambini 24 cm / 05300-06 anello / 05300-05 giunto

Operationslaryngoskop, Kleinsasser  
Operation laryngoscope, Kleinsasser  
Laringoscopios operativo, Kleinsasser  
Laringoscopio operativo, Kleinsasser

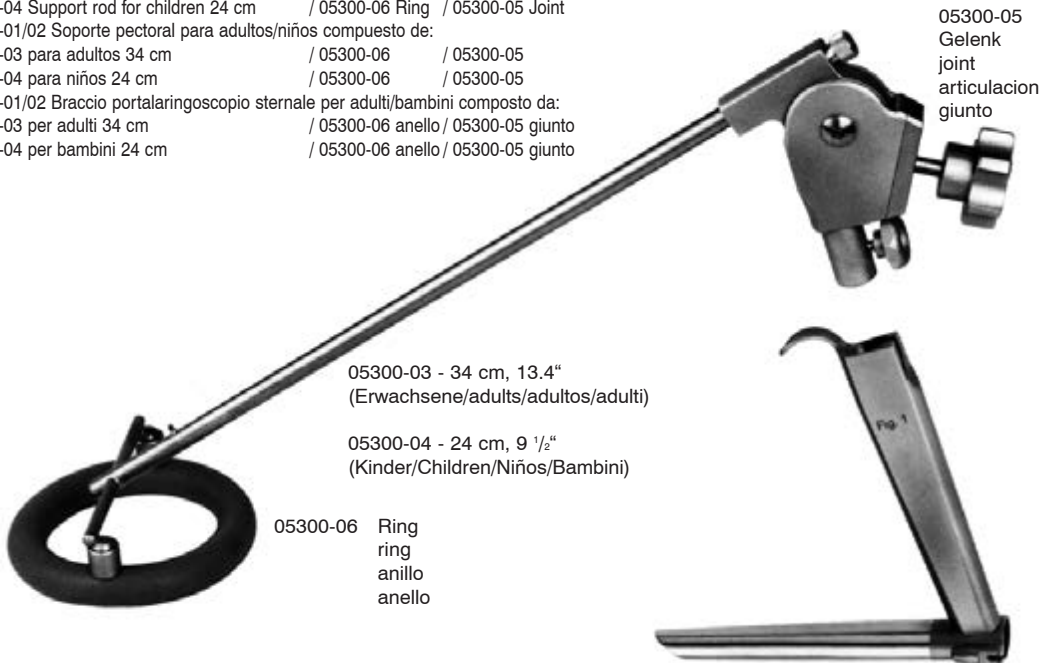

05300-05  
Gelenk  
joint  
articulacion  
giunto

05300-03 - 34 cm, 13.4"  
(Erwachsene/adults/adultos/adulti)

05300-04 - 24 cm, 9 1/2"  
(Kinder/Children/Niños/Bambini)

05300-06 Ring  
ring  
anillo  
anello

Fiberglas-Lichtträger – Fiberglas-light-guide –  
Portador de luz fria – portatore di luce fredda  
a fibre di vetro



05302-01 for Laryngoskope  
05301-01 - 05301-02

05303-01  
Injektionskanüle für Laryngoskope: 05301-01 - 05301-07  
Injetion drain tube for Laryngoscopes: 05301-01 - 05301-07  
Canúla de inyeccion para laringoscopios: 05301-01 - 05301-07  
Cannula da iniezione per laringoscopi: 05301-01 - 05301-07

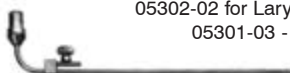

05302-02 for Laryngoskope  
05301-03 - 05301-06

05304-01  
Rauchabsaugrohr für Laryngoskop: 05301-03 - 05301-07  
Suction tube for Laryngoscopes: 05301-03 - 05301-07  
Canúla de succion para laringoscopios: 05301-03 - 05301-07  
Tubo di aspirazione per laringoscopi: 05301-03 - 05301-07

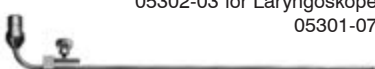

05302-03 for Laryngoskope  
05301-07



Laryngoskope  
Laryngoscopes  
Laringoscopios  
Laringoscopi

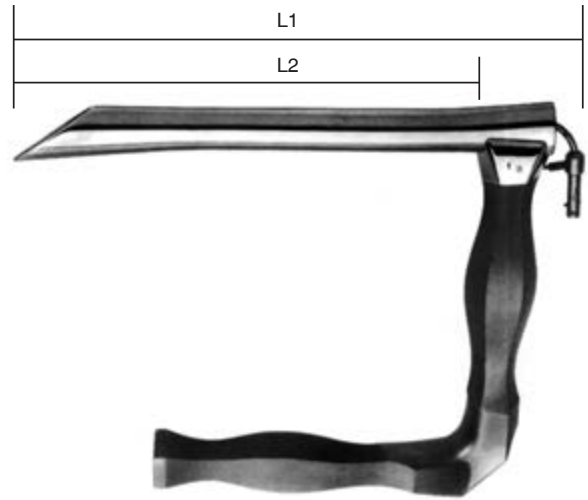

## HOLINGER

Nr.	L1	L2	Lichtträger light guide Portador de luz portatore di luce
05310-01	180 mm	157 mm	05311-01
05310-02	170 mm	146 mm	05311-02
05310-03	120 mm	98 mm	05311-03
05310-04	90 mm	77 mm	05311-04

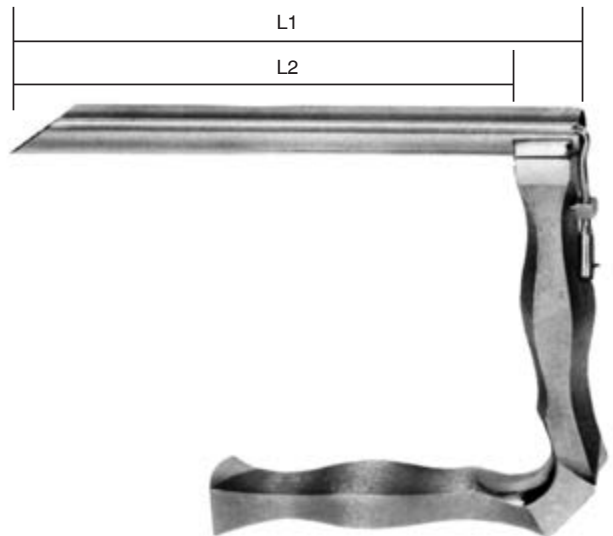

## JACKSON

Nr.	L1	L2	Außen-Dm Outer-dm dm-exterior dm-esterno	Innen-Dm Inner-dm dm-interior dm-interno	Lichtträger light guide Portador de luz portatore di luce
05320-01	160 mm	135 mm	17,5 mm	14,5 mm	05321-01
05320-02	160 mm	135 mm	14,5 mm	12,0 mm	05321-02
05320-03	120 mm	105 mm	14,0 mm	11,5 mm	05321-03
05320-04	90 mm	75 mm	13,0 mm	10,0 mm	05321-04

Skalpelli-Griffe  
 Scalpel Handles  
 Mangos de bisturíes  
 Manici per lama bisturi

passend zu den Klängen  
 for blades  
 para las hojas  
 per lama bisturi

Ⓐ No. 10, 11, 12, 13, 14, 15, 16, 17, 18, 19

Ⓑ No. 20, 21, 22, 23, 24, 25



07103-00

Fig. 3

Ⓐ



07103-01

Fig. 3 grad.

Ⓐ



07103-02

Fig. 3 L

Ⓐ

Skalpell-Griffe  
Scalpel Handles  
Mangos de bisturías  
Manici per lama bisturi



07104-00  
Fig. 4  
Ⓟ



07104-02  
Fig. 4 L  
Ⓟ

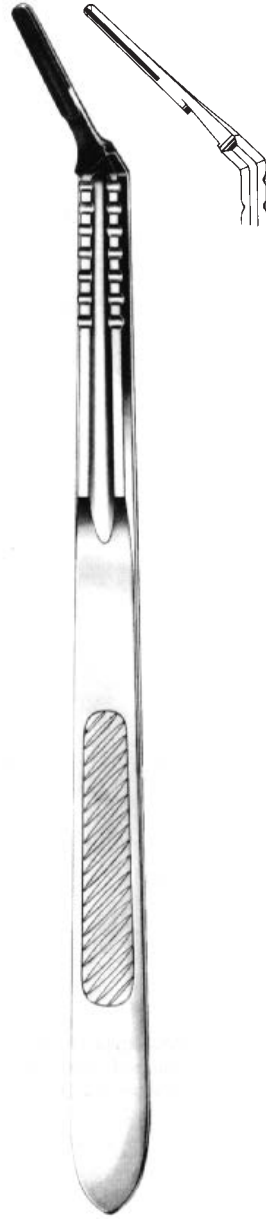

07105-02  
Fig. 4 L  
Ⓟ

Skalpelli-Griffe  
Scalpel Handles  
Mangos de bisturíes  
Manici per lama bisturi



07106-01  
14,5 cm 5 3/4"

(A)



07106-02  
14 cm 5 1/2"

(A)

Skalpelli-Griffe  
Scalpel Handles  
Mangos de bisturíes  
Manici per lama bisturi



07107-00  
16,5 cm, 6 1/2"  
Fig. 7  
Ⓐ



07107-01  
12 cm, 4 3/4"  
Fig. 7K  
Ⓐ



07107-03  
22,5 cm, 8.9"  
Ⓐ



07107-04  
22,5 cm, 8.9"  
Ⓐ

Skalpelli-Griffe  
Scalpel Handles  
Mangos de bisturíes  
Manici per lama bisturi



07108-00  
Fig. 8

(A)

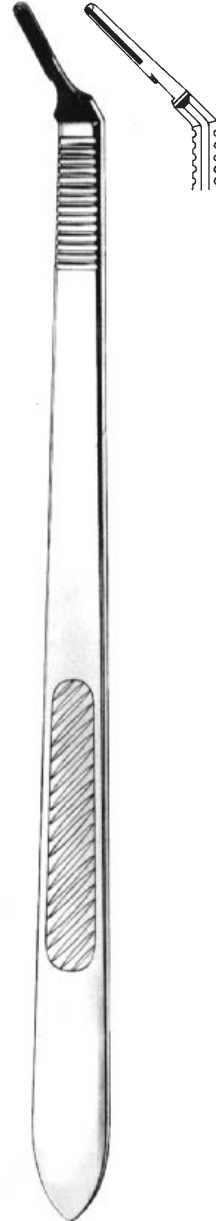

07109-03  
Fig. 3 L

(A)



Skalpelli-Griffe  
Scalpel Handles  
Mangos de bisturías  
Manici per lama bisturi



07161-00 07162-00 07165-00 07167-00

Packung mit 10 Stück  
box of 10  
en cajas de 10 pzas  
confezione di 10

07109-10 10,0 cm, 4"  
07109-13 13,0 cm, 5"  
07109-15 15,5 cm, 6"

Skalpelli-Klingen, Steril  
Scalpel Blades, Sterile  
Hojas de bisturí, estéril  
Lame per bisturi, sterili

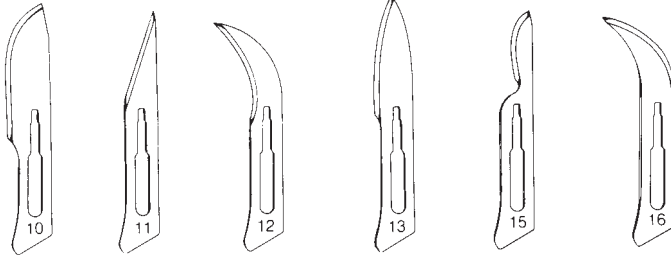

07110-00

07111-00

07112-00

07113-00

07115-00

07116-00

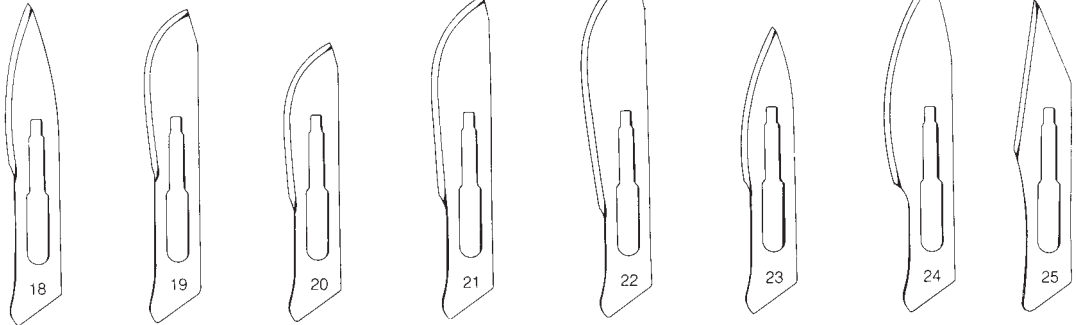

07118-00

07119-00

07120-00

07121-00

07122-00

07123-00

07124-00

07125-00



Packung mit 100 Stück  
in packages of 100 each  
en cajas de 100 c/u  
confezione di 100 pezzi

Skalpelli-Klingen-Entferner  
Scalpel Blade Remover  
Quita hojas  
Togliilama



07130-00



Amputationsmesser  
Amputation Knives  
Cuchillos para amputaciòn  
Coltelli per amputazione

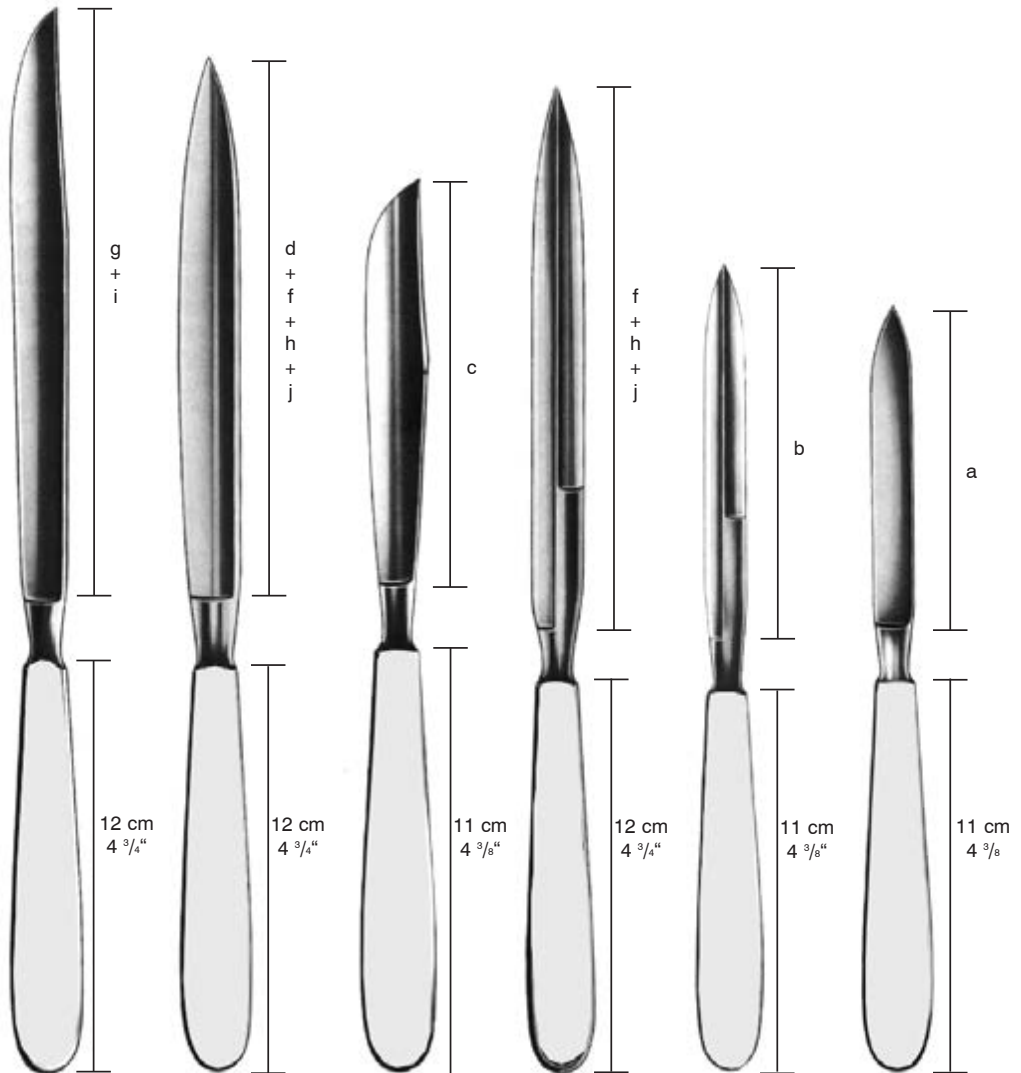

LISTON  
07200-17  
07200-20

REDA  
07201-13  
07201-16  
07201-19  
07201-22

LANGENBECK  
07202-12

CATLIN  
doppelschneidig  
double cutting  
filo doble  
doppio taglio  
07203-16  
07203-19  
07203-22

07204-11  
Zwischenknochen-  
messer doppel-  
schneidig  
Inerosseous knife  
double cutting  
Cuchillo interóseo  
filo doble  
Coltello interosseo  
doppio taglio

07205-09  
Phalangen-  
messer  
Phalangeal knife  
Cuchillos para  
falanges  
Coltello per falangi

Schnittlänge  
Length of blades  
Largo de hojas  
Lunghezze delle lame

a - 9,5 cm	c - 12,0 cm	e - 15,0 cm	g - 17,0 cm	i - 20,0 cm
b - 11,0 cm	d - 13,0 cm	f - 16,0 cm	h - 19,0 cm	j - 22,0 cm
a - 3 3/4"	c - 4 3/4"	e - 6"	g - 6 3/4"	i - 8"
b - 4 3/8"	d - 5"	f - 6 1/4"	h - 7 1/2"	j - 8 3/4"

Klingenbrecher, Rasierklingen  
Blade Breakers, Razor Blades  
Rompe-hojas, hojas de afeitar  
Lama di rasoio, Rompilamette



TROUTMAN-CHRIS  
07290-09 9 cm, 3 1/2"



REDA  
07291-11 11 cm, 4 3/8"



CASTROVIEJO  
07294-13 13 cm, 5 1/8"

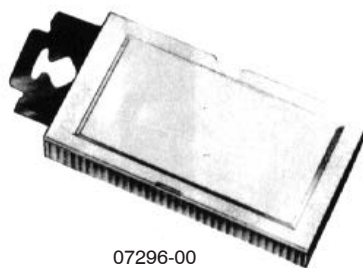

07296-00

Packung = 10 Stück  
package = 10 each  
caja = 10 c/u  
confezione = 10 pezzi

Skalpelle mit Metallheft  
 Scalpels with Metal Handle  
 Bisturíes, mango metálico  
 Bisturi, manico di metallo



Fig. 1  
 07402-01  
 15 cm, 6"  
 30 mm, 1.2"



Fig. 2  
 07402-02  
 15 cm, 6"  
 36 mm, 1.4"



Fig. 3  
 07402-03  
 15,5 cm, 6"  
 40 mm, 1 1/2"



Fig. 4  
 07402-04  
 16 cm, 6 1/4"  
 45 mm, 1 3/4"



Fig. 5  
 07402-05  
 16 cm, 6 1/4"  
 50 mm, 2"



Fig. 6  
 07402-06  
 15 cm, 6"  
 27 mm, 1"



Fig. 7  
 07402-07  
 15 cm, 6"  
 35 mm, 1.4"



Fig. 8  
 07402-08  
 16 cm, 6 1/4"  
 40 mm, 1 1/2"



Fig. 9  
 07402-09  
 16 cm, 6 1/4"  
 47 mm, 1.9"



Fig. 10  
 07402-10  
 17 cm, 6 3/4"  
 50 mm, 2"

Resektions- und Knorpelmesser  
 Resection and Cartilage Knives  
 Cuchillos para resección/cartilagos  
 Coltelli per resezione e cartilagini



6,5 cm  
2.6"

Beinhautmesser  
 mit Schaber  
 Periosteum Knife  
 with raspatory  
 Cuchillo para  
 periostio, con  
 periostótamo  
 Coltello per  
 periostio con  
 raschino

19 cm, 7 1/2"

07403-01

Metallheft  
 metal handle  
 mango metálico  
 manico di metallo



6,5 cm  
2.6"

19 cm, 7 1/2"

07403-02

Holzheft  
 wooden handle  
 mango de madera  
 manico in legno



5,5 cm  
2.2"

18 cm, 7"

LANGENBECK  
07410-05



18 cm, 7"

LANGENBECK  
07412-05

Sezier-, Hirn- und Organmesser  
Autopsy- Brain- and Post mortem knives  
Cuchillos para autopsia- cerebro- órganos  
Coltelli per cartilagini- cervello e organi

Schnittlänge  
Length of blades  
Largo de hojas  
Lunghezze delle lame

- a - 8,5 cm, 3,4"
- b - 9,5 cm, 3 3/4"
- c - 11,0 cm, 4 3/8"
- d - 14,0 cm, 5 1/2"
- e - 16,0 cm, 6 1/4"
- f - 17,0 cm, 6 3/4"
- g - 19,5 cm, 7 3/4"
- h - 20,0 cm, 8"
- i - 24,0 cm, 9 1/2"

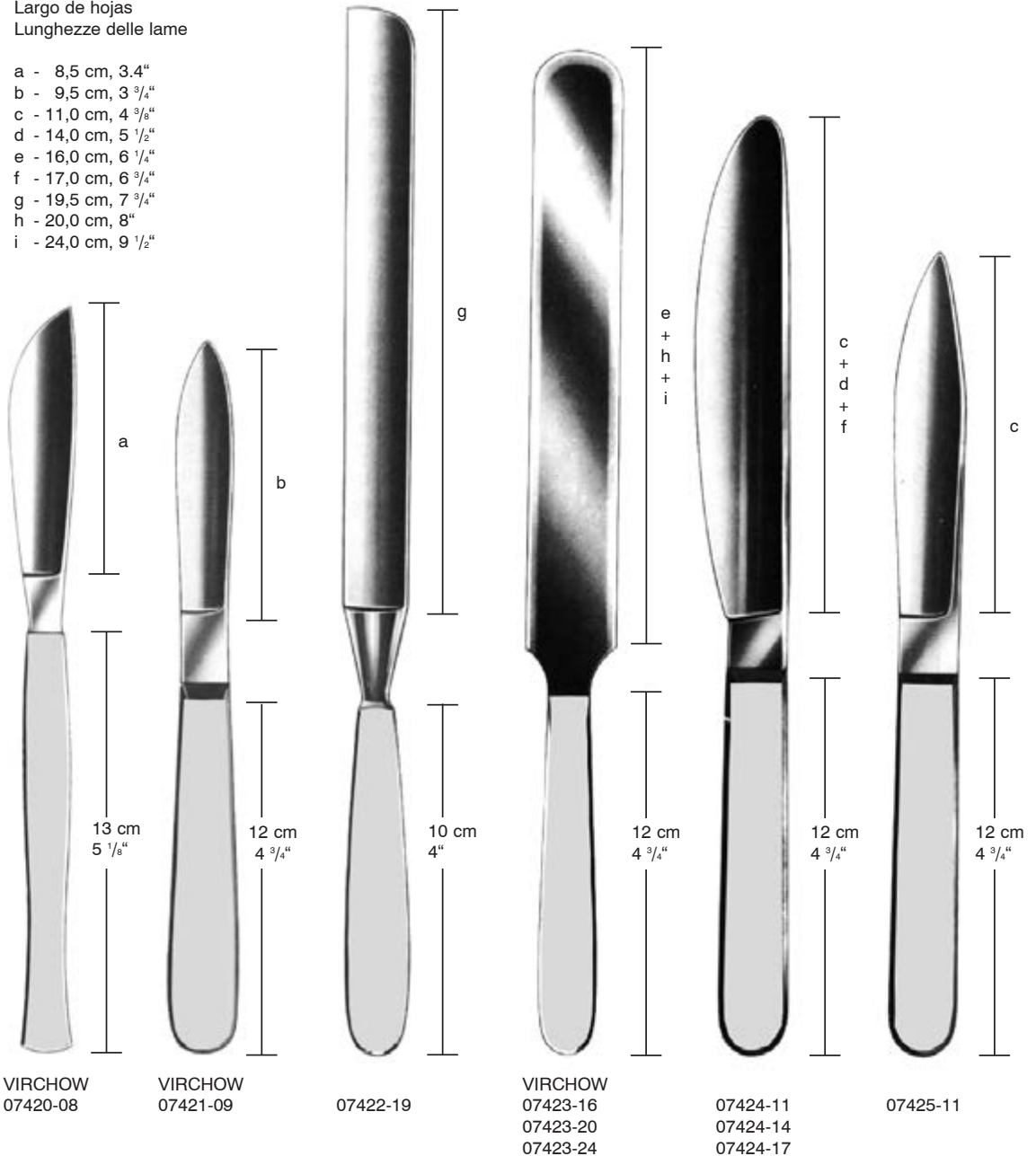



Dermatome, Rasiermesser  
 Dermatome, Razor  
 Dermátomo, Navajas  
 Dermatomo, Rasoio



SCHINK  
 07490-00  
 30 cm, 11 3/4"  
 0,1 - 2 mm  
 compl.  
 mit/with/con

07490-01 (1) Stk./ pcs/ pzas  
 07490-02 (2) Stk./ pcs/ pzas



07490-01  
 Ersatzklinge  
 Spare blade  
 Hoja de repuesto  
 Lama di ricambio per dermatomo

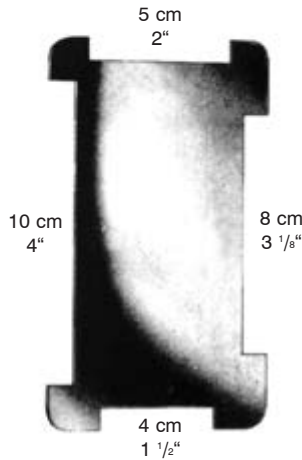

07490-02  
 Spannplatte  
 Skin straightening plate  
 Placa para extender la piel  
 Placca per stendipelle



07496-00  
 Rasiermesser 8 cm, 3 1/8"  
 Razors 8 cm, 3 1/8"  
 Navajas 8 cm, 3 1/8"  
 Rasoio 8 cm, 3 1/8"

Dermatome  
 Dermatome  
 Dermátomo  
 Dermatomo



07496-31  
 Ersatzklingen  
 Spare blades  
 Hoja de repuesto  
 Lama di ricambio



07296-00  
 Ersatzklingen  
 Spare blades  
 Hoja de repuesto  
 Lama di ricambio



07499-01  
 Ersatzklingen  
 Spare blades  
 Hoja de repuesto  
 Lama di ricambio

für handelsübliche Rasierklingen  
 for usual razor blades  
 para hojas de afeitar usuales  
 per lamette da barba normali

**HUMBY**  
 07495-31 31 cm, 12 1/4"  
 0,1 - 1,5 mm  
 mit 1 Klinge  
 with 1 blade  
 con 1 hoja  
 con 1 lama

**SILVER**  
 07498-00 19 cm, 7 1/2"  
 mit 1 Klinge  
 with 1 blade  
 con 1 hoja  
 con 1 lama

**WATSON**  
 07499-00 30 cm, 11 3/4"  
 0,1 - 1,5 mm  
 mit 1 Klinge  
 with 1 blade  
 con 1 hoja  
 con 1 lama

Chirurgische Scheren  
 Operating Scissors  
 Tijeras para cirugía  
 Forbici per chirurgia

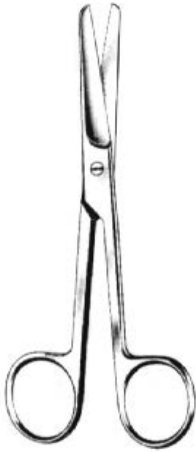

STANDARD

- 09102-11 11,5 cm, 4 1/2"
- 09102-13 13,0 cm, 5"
- 09102-14 14,5 cm, 5 3/4"
- 09104-14 TC**
- 09102-15 15,5 cm, 6"
- 09102-16 16,5 cm, 6 1/2"
- 09102-18 18,5 cm, 7 1/4"
- 09102-20 20,0 cm, 8"



STANDARD

- 09110-11 11,5 cm, 4 1/2"
- 09110-13 13,0 cm, 5"
- 09110-14 14,5 cm, 5 3/4"
- 09114-14 TC**
- 09110-15 15,5 cm, 6"
- 09110-16 16,5 cm, 6 1/2"
- 09110-18 18,5 cm, 7 1/4"
- 09110-20 20,0 cm, 8"



STANDARD

- 09120-11 11,5 cm, 4 1/2"
- 09120-13 13,0 cm, 5"
- 09120-14 14,5 cm, 5 3/4"
- 09124-14 TC**
- 09120-15 15,5 cm, 6"
- 09120-16 16,5 cm, 6 1/2"
- 09120-18 18,5 cm, 7 1/4"
- 09120-20 20,0 cm, 8"



STANDARD

- 09103-11 11,5 cm, 4 1/2"
- 09103-13 13,0 cm, 5"
- 09103-14 14,5 cm, 5 3/4"
- 09105-14 TC**
- 09103-15 15,5 cm, 6"
- 09103-16 16,5 cm, 6 1/2"
- 09103-18 18,5 cm, 7 1/4"
- 09103-20 20,0 cm, 8"



STANDARD

- 09111-11 11,5 cm, 4 1/2"
- 09111-13 13,0 cm, 5"
- 09111-14 14,5 cm, 5 3/4"
- 09115-14 TC**
- 09111-15 15,5 cm, 6"
- 09111-16 16,5 cm, 6 1/2"
- 09111-18 18,5 cm, 7 1/4"
- 09111-20 20,0 cm, 8"

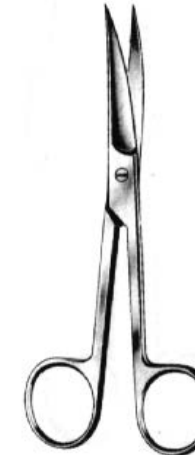

STANDARD

- 09121-11 11,5 cm, 4 1/2"
- 09121-13 13,0 cm, 5"
- 09121-14 14,5 cm, 5 3/4"
- 09125-14 TC**
- 09121-15 15,5 cm, 6"
- 09121-16 16,5 cm, 6 1/2"
- 09121-18 18,5 cm, 7 1/4"
- 09121-20 20,0 cm, 8"

Chirurgische Scheren  
 Operating Scissors  
 Tijeras para cirugía  
 Forbici per chirurgia



Inzisionsschere  
 Incision Scissors  
 Tijera de incision  
 Forbici per incisione

09128-14  
 14,0 cm  
 5 1/2"

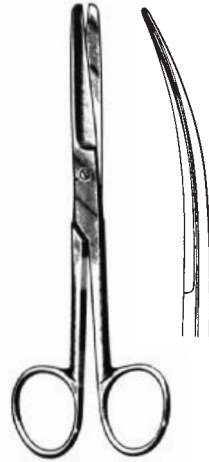

— DEAVER —  
 09130-14 14 cm 09131-14  
 5 1/2"

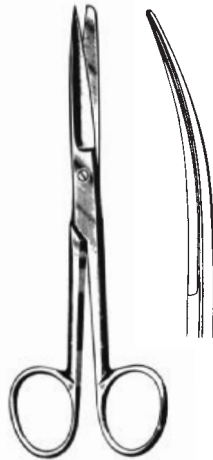

— DEAVER —  
 09140-14 14 cm 09141-14  
 5 1/2"

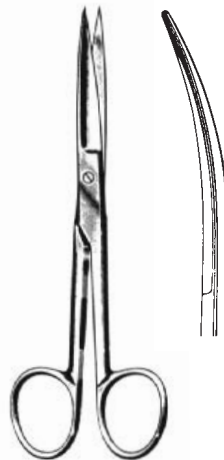

— DEAVER —  
 09150-14 14 cm 09151-14  
 5 1/2"

Präparierscheren  
 Dissecting Scissors  
 Tijeras de disección  
 Forbici per dissezione



MAYO

09160-14	14,5 cm	09161-14
<b>09164-14 TC</b>	5 3/4"	<b>09165-14 TC</b>
09160-17	17,0 cm	09161-17
<b>09164-17 TC</b>	6 3/4"	<b>09165-17 TC</b>
09160-19	19,0 cm	09161-19
	7 1/2"	
09160-23	23,0 cm	09161-23
<b>09164-23 TC</b>	9"	<b>09165-23 TC</b>
09160-28	28,0 cm	09161-28
	11"	

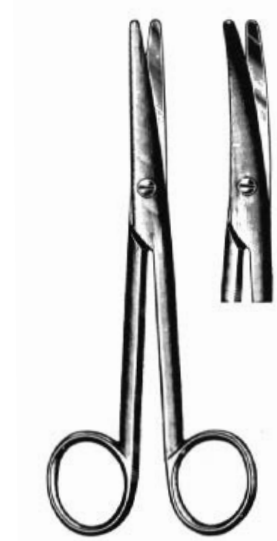

MAYO-STILLE

09170-15	15,0 cm	09171-15
<b>09174-15 TC</b>	6"	<b>09175-15 TC</b>
09170-17	17,0 cm	09171-17
<b>09174-17 TC</b>	6 3/4"	<b>09175-17 TC</b>
09170-21	21,0 cm	09171-21
<b>09174-21 TC</b>	8 1/4"	<b>09175-21 TC</b>

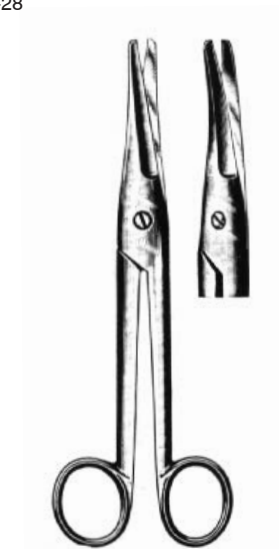

MAYO-NOBLE

09180-17	17,0 cm	09181-17
	6 3/4"	



Präparierscheren  
Dissecting Scissors  
Tijeras de disección  
Forbici per dissezione



LEXER  
09190-16  
**09194-16 TC**  
16 cm, 6 1/4"

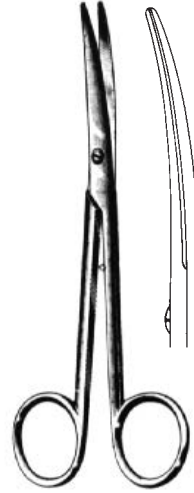

LEXER  
09191-16  
**09195-16 TC**  
16 cm, 6 1/4"



— LEXER BABY —  
09202-10 09203-10  
**09206-10 TC 09207-10 TC**  
10 cm, 4"

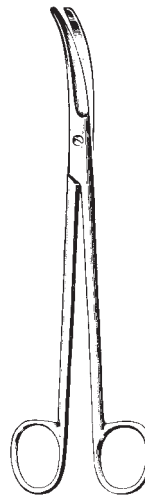

JORGENSEN  
09204-22  
22 cm, 8 3/4"

Präparierscheren  
Dissecting Scissors  
Tijeras de disección  
Forbici per dissezione



METZENBAUM	
09280-12	09284-12 TC
12 cm	4 3/4"
09280-15	09284-15 TC
15 cm	6"
09280-18	09284-18 TC
18 cm	7"
09280-20	09284-20 TC
20 cm	8"
09280-23	09284-23 TC
23 cm	9"
09280-25	09284-25 TC
25 cm	10"
09280-28	09284-28 TC
28 cm	11"
09280-30	09284-30 TC
30 cm	12"



METZENBAUM	
09281-12	09285-12 TC
12 cm	4 3/4"
09281-15	09285-15 TC
15 cm	6"
09281-18	09285-18 TC
18 cm	7"
09281-20	09285-20 TC
20 cm	8"
09281-23	09285-23 TC
23 cm	9"
09281-25	09285-25 TC
25 cm	10"
09281-28	09285-28 TC
28 cm	11"
09281-30	09285-30 TC
30 cm	12"



METZENBAUM FINO	
09282-15	09286-15 TC
15 cm	6"
09282-18	09286-18 TC
18 cm	7"
09282-20	09286-20 TC
20 cm	8"
09282-23	09286-23 TC
23 cm	9"
09282-25	09286-25 TC
25 cm	10"
09282-28	09286-28 TC
28 cm	11"

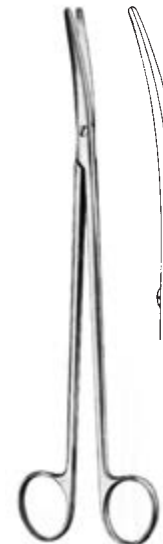

METZENBAUM FINO	
09283-15	09287-15 TC
15 cm	6"
09283-18	09287-18 TC
18 cm	7"
09283-20	09287-20 TC
20 cm	8"
09283-23	09287-23 TC
23 cm	9"
09283-25	09287-25 TC
25 cm	10"
09283-28	09287-28 TC
28 cm	11"



Präparierschere, Kapselschere  
Dissecting Scissors, Capsula Scissor  
Tijeras de disección, Tijera p. cápsula  
Forbici per dissezione, Forbici per capsula



WELLER  
09289-28  
28 cm, 11"



RESANO  
09290-25  
25 cm, 10"

Präparierscheren, Ligaturscheren  
 Dissecting Scissors, Ligature Scissors  
 Tijeras de disección, Tijeras para ligaduras  
 Forbici per dissezione, Forbici per legature



METZENBAUM "S"

09291-18 18 cm, 7" 09295-18 TC  
 09291-20 20 cm, 8" 09295-20 TC  
 09291-23 23 cm, 9" 09295-23 TC

**Wellenschliff - wave cut**

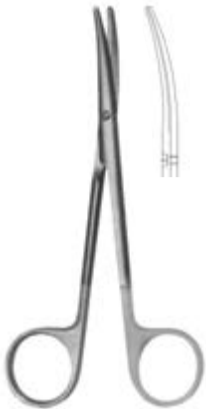

09296-15 TC  
 14,5 cm 5 3/4"



09296-18 TC  
 18 cm 7"



09296-23 TC  
 23 cm 9"

Präparierscheren  
 Dissecting Scissors  
 Tijeras de disección  
 Forbici per dissezione

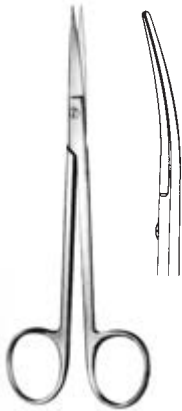

— SANVENERO —  
 09302-14 14 cm 09303-14  
 5 1/2"



— JOSEPH —  
 09304-14 14 cm 09305-14  
 5 1/2"

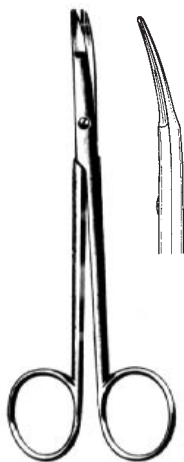

KILNER  
 09310-12 12 cm **09314-12 TC**  
 09310-15 15 cm  
 09312-12 12 cm gerade/straight/recta/retta



— REYNOLDS —  
 09320-15 15 cm 09321-15  
 09321-18  
**09325-15 TC**

Chirurgische Scheren, fein  
 Operating Scissors, fine  
 Tijeras para cirugía, finas  
 Forbici per chirurgia, fine



IRIS



09340-09 9 cm  
 09340-10 10 cm  
 09340-11 11 cm  
**09344-11 TC**

gerade  
 straight  
 rectas  
 rette



09341-09  
 09341-10  
 09341-11  
**09345-11 TC**

gebogen  
 curved  
 curvas  
 curve

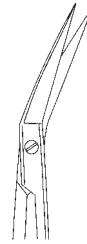

09346-11 11 cm

abgewinkelt  
 angled  
 angulada  
 angolata

Chirurgische Scheren, Präparierscheren  
Operating Scissors, Dissecting Scissors  
Tijeras para cirugía, Tijeras de disección  
Forbici per chirurgia, Forbici per dissezione

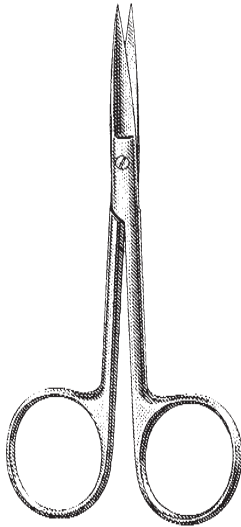

KNAPP  
10 cm, 4"  
09348-01 09348-02

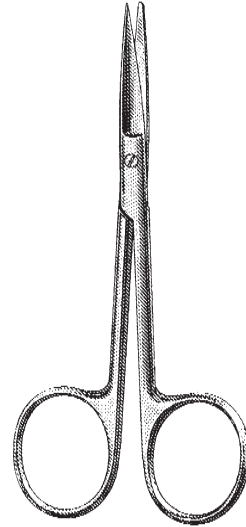

KNAPP  
10 cm, 4"  
09348-03 09348-04

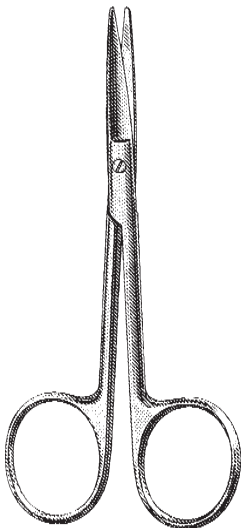

KNAPP  
10 cm, 4"  
09348-05 09348-06



LITTLER  
12 cm, 4 3/4"  
09349-12

Präparierscheren, feines Modell  
Dissecting Scissors, fine pattern  
Tijeras de disección, finas  
Forbici per preparazione, modello fino

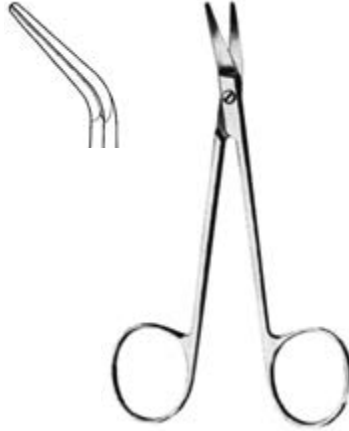

GRAEFE  
09350-10  
10 cm 4"



COTTLE  
09358-11  
11,5 cm 4 1/2"

Präparierscheren, feines Modell  
Dissecting Scissors, fine pattern  
Tijeras de disección, finas  
Forbici per preparazione, modello fino



— GRADLE —  
09350-09 9,5 cm, 3<sup>3</sup>/<sub>4</sub>" 09351-09



— —  
09352-09 9,5 cm, 3<sup>3</sup>/<sub>4</sub>" 09353-09



— —  
09354-10 10 cm, 4" 09355-10



— —  
09356-10 10 cm, 4" 09357-10

Scheren  
Scissors  
Tijeras  
Forbici

Sehnenscheren  
Tendon Scissors  
Tijeras para tendones  
Forbici per tenotomia

Enucleationsschere  
Enucleation Scissors  
Tijera para enucleación  
Forbici per enucleazione

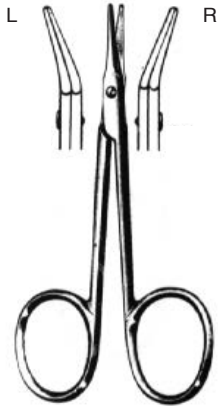

09347-09 AEBLI 9 cm 09349-09  
3 1/2"



STEVENS  
11 cm  
4 3/8"



09360-11 09361-11  
09362-11 09363-11



LANDOLT  
09381-11  
12 cm, 4 3/4"

Nasenscheren - Nasal Scissors - Tijeras nasales - Forbici nasali



STRABISMUS  
09370-11 09371-11  
09374-11 TC 09375-11 TC  
11 cm, 4 3/8"



HEYMANN  
09401-18  
18 cm, 7"



FOMON  
09403-15  
15 cm, 6"



Tonsillen-, Gefäßscheren  
 Tonsil, Vascular Scissors  
 Tijeras amígdalas y vasculares  
 Forbici per tonsilli e vascolari



COTTLE  
 09405-16  
**09406-16 TC**  
 16 cm, 6 1/4"

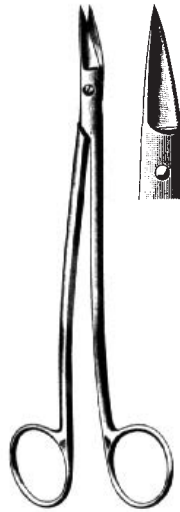

DEAN  
 09425-17 09427-17  
 17 cm, 6 3/4"

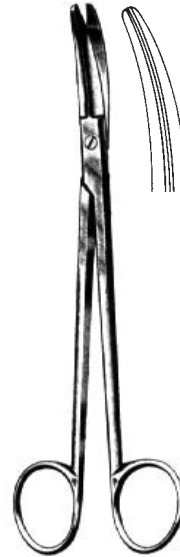

BOETTCHER  
 09435-18  
 18 cm, 7"

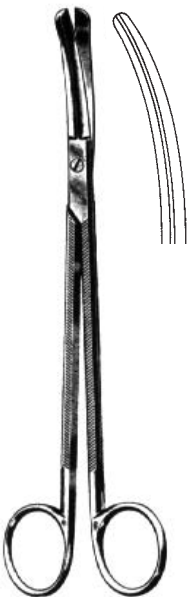

GOOD  
 09437-19  
 19 cm, 7 1/2"

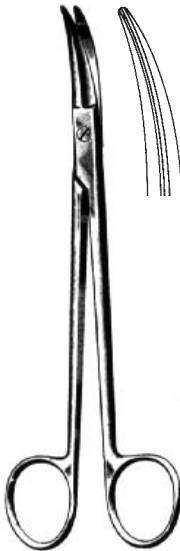

PRINCE  
 09439-17  
 17 cm, 6 3/4"



09468-15  
 15 cm, 6"



09470-11  
 11 cm, 4 3/8"

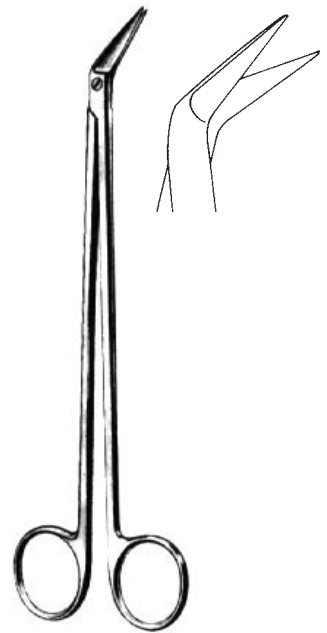

POTTS-DE MARTEL  
 09473-21  
 21 cm, 8 1/4"

Scheren, Thorax und Gefäße  
 Scissors, thorax and vascular  
 Tijeras, torácicas y vasculares  
 Forbici vascolari e toraciche



DIETRICH  
 09475-25 – 09475-00  
 17 cm, 6 3/4"



09475-25  
**09476-25 TC**  
 18 cm, 7"

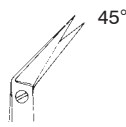

09475-45  
**09476-45 TC**  
 18 cm, 7"

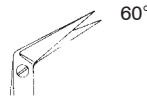

09475-60  
**09476-60 TC**  
 17,5 cm, 6,9"

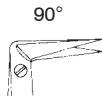

09475-90  
**09476-90 TC**  
 17 cm, 6 3/4"



09475-00  
**09476-00 TC**  
 17 cm, 6 3/4"



DIETRICH  
 09477-01  
 17 cm, 6 3/4"

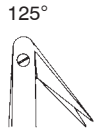

DE BAKEY  
 (POTTS-SMITH)



**09478-25**  
 19 cm  
 7 1/2"



**09478-45**  
 19 cm  
 7 1/2"



**09478-60**  
 19 cm  
 7 1/2"



**09479-25**  
 23 cm  
 9"

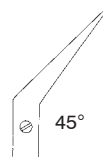

**09479-45**  
 23 cm  
 9"

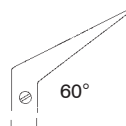

**09479-60**  
 23 cm  
 9"

Gefäßscheren  
 Vascular Scissors  
 Tijeras vasculares  
 Forbici vascolari



POTTS-SMITH  
 19 cm, 7 1/2"

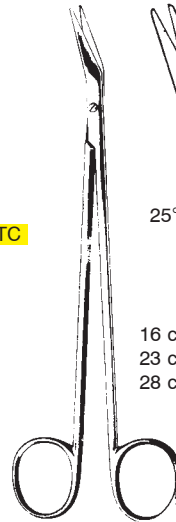
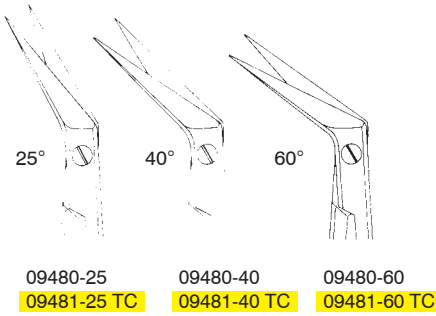

DE BAKEY

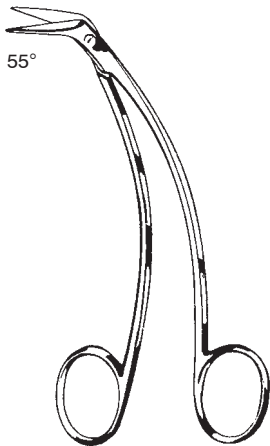
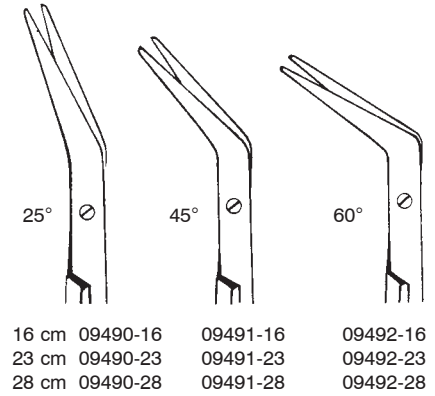

FAVALORO  
 09496-15    15 cm, 6"

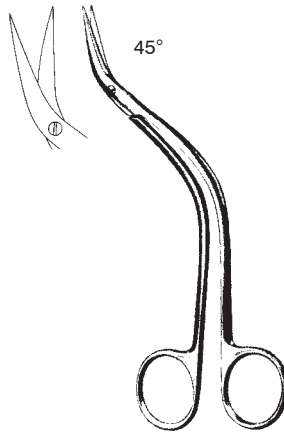

DE BAKEY  
 09497-15    15,5 cm, 6"



KELLY  
 09540-16    09541-16  
**09542-16 TC**    **09543-16 TC**  
 16 cm, 6 1/4"

Gynäkologische Scheren  
 Gynecological Scissors  
 Tijeras ginecológicas  
 Forbici ginecologiche



SIMS

09510-20	20 cm, 8"	09511-20
09510-23	23 cm, 9"	09511-23
09516-23 TC	23 cm, 9"	09517-23 TC



09512-20  
 09512-23



09513-20  
 09513-23



09514-20  
 09514-23



09515-20  
 09515-23



SIEBOLD

09523-24 24 cm, 9 1/2"

Gynäkologische Scheren  
 Gynecological Scissors  
 Tijeras ginecológicas  
 Forbici ginecologiche

Parametriumscheren - Parametrium scissors - Parametrium nasales - Parametrium nasali

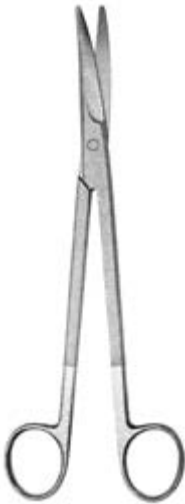

REDA

09501-23	23 cm, 9"
09505-23 TC	23 cm, 9"
09505-26 TC	26 cm, 10 1/4"
09505-30 TC	30 cm, 12"



09501-22	22,5 cm, 8.9"
09507-23 TC	23 cm, 9"
09507-26 TC	26 cm, 10 1/4"
09507-30 TC	30 cm, 12"



WERTHEIM

09525-22 22,5 cm, 8.9"



DOYEN

09530-17 09531-17  
17,5 cm, 6.9"



DUBOIS

09536-27 09537-27  
27 cm, 10 1/2"

Episiotomiescheren, Nabelschnurscheren  
 Episiotomy Scissors, Umbilical Scissors  
 Tijeras para episiotomía, Tijeras umbilicales  
 Forbici per episiotomia, Forbici ombelicali



gezahnt  
 saw edge  
 dentadas  
 dentellata

WALDMANN  
 09548-18  
 18 cm, 7"



U.S.A. Mod.  
 09550-10  
 10,5 cm, 4"

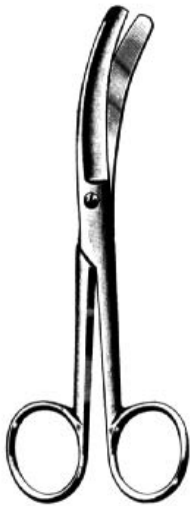

BUSCH  
 09551-16  
 16 cm, 6 1/4"



SCHUMACHER  
 09553-16  
 16 cm, 6 1/4"



BRAUN-STADLER  
 09560-14 14,5 cm, 5 3/4"  
 09560-22 22,0 cm, 8 3/4"

Neurochirurgische Scheren, Gefäßschere, Präparierscheren  
 Neurosurgical Scissors, Vascular Scissors, Dissecting Scissors  
 Tijera para neurocirugía, Tijeras vasculares, Tijeras de disección  
 Forbici per neurochirurgia, Forbici vascolari, Forbici per preparazione

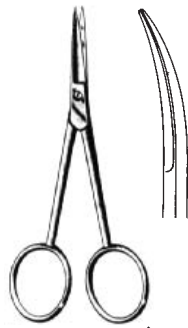

09580-11 09581-11  
 11 cm, 4 3/8"

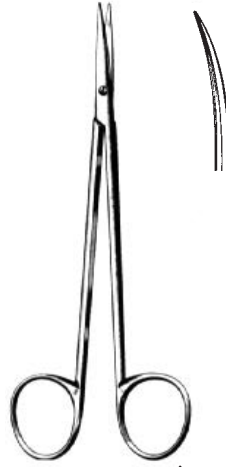

09582-15 09583-15  
 15 cm, 6"

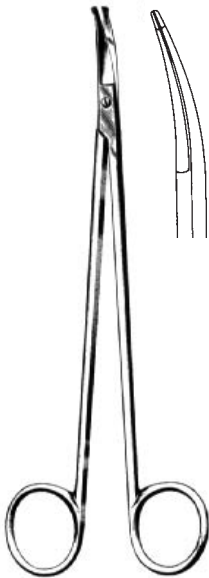

STRULLY  
 09601-22  
 22 cm, 8 3/4"



TOENNIS-ADSON  
 09610-18  
 18 cm, 7"

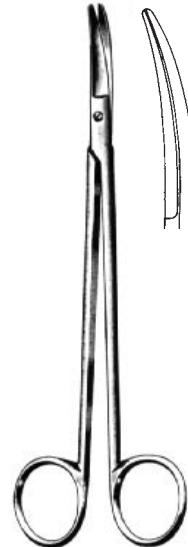

TOENNIS-ADSON  
 09611-18  
 18 cm, 7"

Knorpelscheren, Nasenschere, Gefäßscheren  
 Cartilage Scissors, Nasel Scissors, Vascular Scissors  
 Tijeras para cartilago, Tijeras nasales, Tijeras vasculares  
 Forbici per cartilagene, Forbici nasali, Forbici vascolari

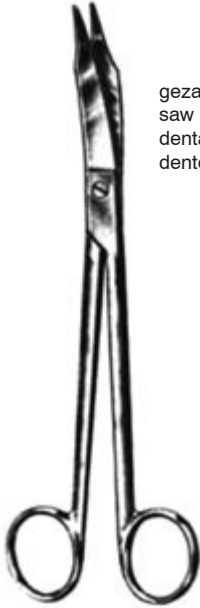

gezahnt  
 saw edge  
 dentadas  
 dentellata

MARTIN  
 09613-20  
 20 cm, 8"



McINDOE  
 09614-19  
 19 cm, 7 1/2"



FOMON  
 09617-13  
 13 cm, 5 1/8"



SCHMIEDEN-TAYLOR  
 09619-17  
 17 cm, 6 3/4"



Gefäßscheren, Präparierscheren  
Vascular Scissors, Dissecting Scissors  
Tijeras vasculares, Tijeras de disección  
Forbici vascolari, Forbici per preparazione

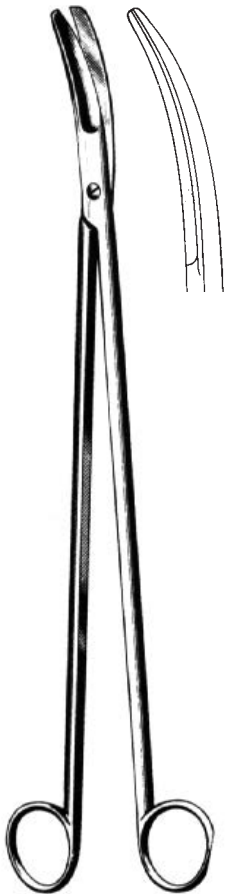

CRAFOORD  
09641-30  
30 cm, 11 <sup>3</sup>/<sub>4</sub>"



THOREK  
09643-19 19 cm, 7 <sup>1</sup>/<sub>2</sub>"  
09643-25 25 cm, 10"

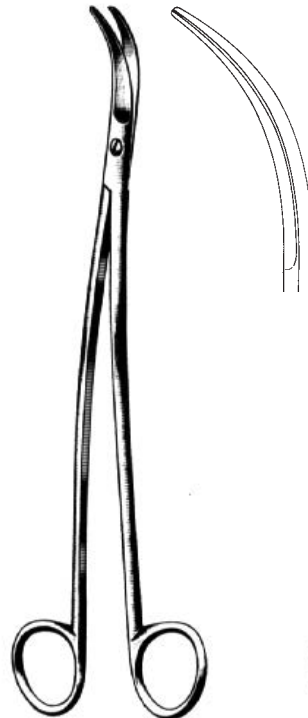

SATINSKY  
09651-24  
24,5 cm, 9 <sup>1</sup>/<sub>2</sub>"

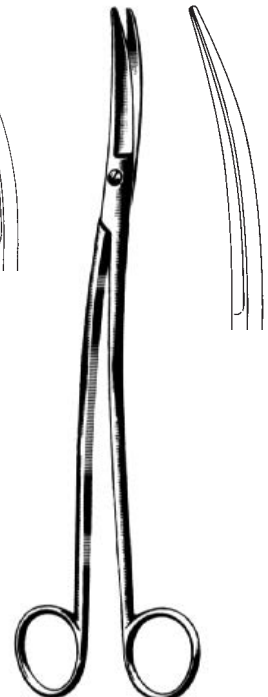

KLINKENBERGH-LOTH  
09661-23  
23 cm, 9"

Darmscheren, Nagelspaltschere, Fadenscheren  
 Enterotomy Scissors, Nail Splitting Scissors, Stitch Scissors  
 Tijeras para intestino, Tijeras para hender uña, Tijeras para hilos  
 Forbici per enterotomia, Forbici per staccare unghie, Forbici per legature



FERGUSSON  
 09770-18  
 18 cm, 7"

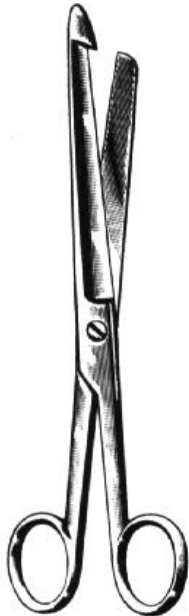

09772-21  
 21 cm, 8 1/4"



09774-21  
 21 cm, 8 1/4"



— SYSTRUNK —  
 09775-13 09777-13  
 13 cm, 5 1/8"



SPENCER  
 09802-09  
 9 cm, 3 1/2"



SPENCER  
 09802-11  
 11 cm, 4 3/8"



NORTHBENT  
 09803-09 9 cm, 3 1/2"  
 09803-13 13 cm, 5 1/8"



LITTAUER  
 09804-14  
 14 cm, 5 1/2"



HEATH  
 09809-15  
 15 cm, 6"

Zahnfleissscheren, feine Scheren, Drahtschere  
 Gum Scissors, Delicate Scissors, Wire Cutting Scissors  
 Tijeras para encías, Tijeras finas, Tijeras para alambre  
 Forbici per gengiva, Forbici delicate, Forbici per filo di metallo

1 Schneide gezahnt  
 1 blade toothed  
 1 hoja dentada  
 1 taglio della lama dentellato

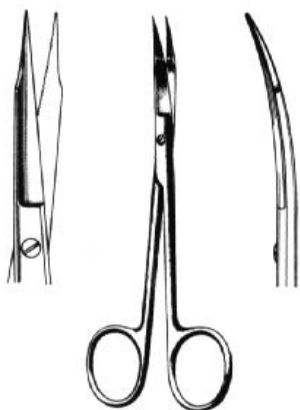

— GOLDMAN-FOX —  
 09820-13 13 cm, 5 1/8" 09821-13

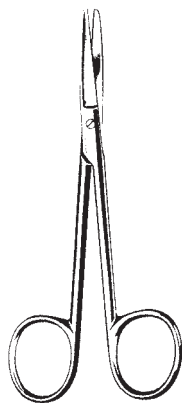

WAGNER  
 12 cm, 4 3/4"

gerade  
 straight  
 rectas  
 rette



Fig. 1  
 09828-12



Fig. 2  
 09826-12



Fig. 3  
 09824-12

gebogen  
 curved  
 curvas  
 curve



Fig. 1  
 09823-12



Fig. 2  
 09829-12



Fig. 3  
 09825-12



QUINBY  
 09827-12 12 cm, 4 3/4"



UNIVERSAL  
 09831-12 12 cm, 4 3/4"  
 09835-12 TC 12 cm, 4 3/4"

Kronenscheren  
Crown Scissors  
Tijeras para coronas  
Forbici per corona

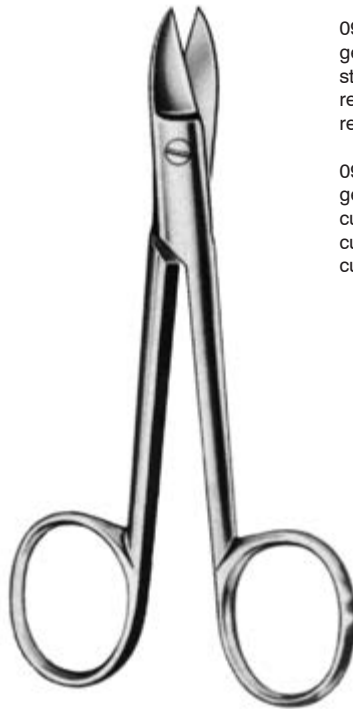

09850-10  
gerade spitz  
straight pointed  
rectas agudas  
rette acute

09851-10  
gebogen spitz  
curved pointed  
curvas agudas  
curve acute

BEEBEE  
10,5 cm, 4"

Zahnfleissscheren  
Gum Scissors  
Tijeras para encias  
Forbici per gengiva



LA GRANGE  
09854-11  
11,5 cm, 4 1/2"



gezahnt  
saw edge  
dentadas  
dentellata

LOCKLIN  
09859-16  
16 cm, 6 1/4"



gezahnt  
saw edge  
dentadas  
dentellata

LOCKLIN  
09860-16  
16,5 cm, 6 1/2"



LOCKLIN  
**09861-16 TC**  
16,5 cm, 6 1/2"

Verbandscheren, Gipsschere  
 Bandage Scissors, Plaster Scissors  
 Tijeras para vendajes, Tijeras para yeso  
 Forbici per bendaggi, Forbici per gesso

Gaze  
 Gauze  
 Gaza  
 Garza



SMITH US ARMY  
 09898-20  
 20 cm, 8"



LISTER  
 9 cm, 3 1/2" 09901-09  
 11 cm, 4 3/8" 09901-11  
 14 cm, 5 1/2" 09901-14  
 18 cm, 7" 09901-18  
 20 cm, 8" 09901-20

09905-14 TC  
 09905-18 TC



LISTER  
 09906-18 18 cm, 7"  
 09906-20 20 cm, 8"



BERGMANN  
 09911-23  
 23 cm, 9"

Gipsscheren, Verbandscheren  
Plaster Scissors, Bandage Scissors  
Tijeras para yeso, Tijeras para vendajes  
Forbici per gesso, Forbici per bendaggi



ESMARCH  
09913-20 20 cm, 8"  
09913-22 22 cm, 8 3/4"



SEUTIN  
09915-23  
23 cm, 9"

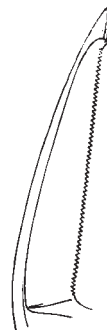

gezahnt  
toothed  
dentadas  
dentellata

REDA EXCENTER  
09921-16 16 cm, 6 1/4"  
09921-19 19 cm, 7 1/2"

Verbandscheren, Gipsschere  
 Bandage Scissors, Plaster Scissors  
 Tijeras para vendajes, Tijeras para yeso  
 Forbici per bendaggi, Forbici per gesso



KNOWLES  
 09930-14  
 14 cm, 5 1/2"



KNOWLES  
 09931-14  
 14 cm, 5 1/2"



LORENZ  
 09933-23  
 23 cm, 9"



BRUNS  
 09935-23 23 cm, 9" **09939-23 TC**  
 AAAAAAAAA 09937-23 23 cm, 9"



09941-20  
 20 cm, 8"

in verschiedenen Farben lieferbar  
 in different colours available  
 en diferentes colores disponibles  
 in differenti colori disponibile



UNIVERSAL  
 09950-15 15 cm, 6"  
 09950-18 18 cm, 7"



Supercut Scheren, gezahnt  
 Supercut Scissors, saw edge  
 Tijeras Supercut, dentadas  
 Forbici Supercut, dentellate



09960-14    09961-14  
 14,5 cm, 5 3/4"



MAYO  
 09962-14    14,5 cm    09963-14  
 09962-17    17,0 cm    09963-17  
 09962-23    23,0 cm    09963-23

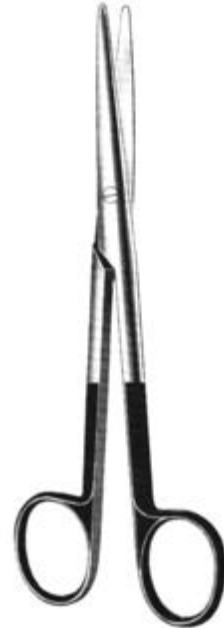

MAYO-STILLE  
 09964-15    15,0 cm    09965-15  
 09964-17    17,0 cm    09965-17



BABY METZENBAUM  
 09966-11    09967-11  
 11,5 cm, 4 1/2"

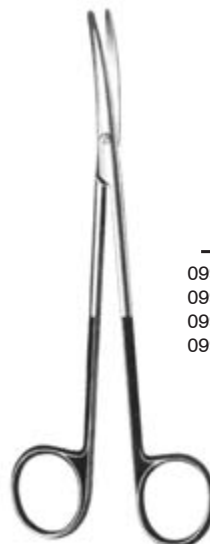

METZENBAUM  
 09970-14    14,5 cm    09971-14  
 09970-18    18,0 cm    09971-18  
 09970-20    20,0 cm    09971-20  
 09970-23    23,0 cm    09971-23

Supercut Scheren, gezahnt  
 Supercut Scissors, saw edge  
 Tijeras Supercut, dentadas  
 Forbici Supercut, dentellate



IRIS  
 09980-11 09981-11  
 11,5 cm, 4 1/2"



WAGNER  
 09982-12 09983-12  
 12 cm, 4 3/4"



STEVENS  
 09984-11 09985-11  
 11,5 cm, 4 1/2"



LaGrange  
 09986-11 11,5 cm, 4 1/2"



LISTER  
 09990-14 14,5 cm, 5 3/4"  
 09990-18 18,0 cm, 7"



REYNOLDS  
 09993-15 15 cm, 6"  
 09993-18 18 cm, 7"



KILNER/RAGNELL  
 09995-12 12 cm, 4 3/4"

Face-Lift-Scheren  
 Face-Lift-Scissors  
 Tijeras para Face-Lift  
 Forbici per Face-Lift



GORNEY  
 19 cm, 7 1/2"



10010-19  
**10012-19 TC**  
 10014-19 Supercut



10011-19  
**10013-19 TC**  
 10015-19 Supercut

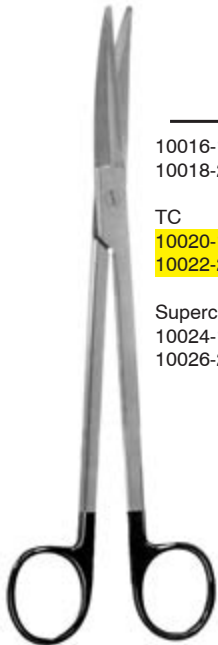

REES

10016-17	17,0 cm, 6 3/4"	10017-17
10018-20	20,5 cm, 8"	10019-20
TC		
<b>10020-17</b>	17,0 cm, 6 3/4"	<b>10021-17</b>
<b>10022-20</b>	20,5 cm, 8"	<b>10023-20</b>
Supercut		
10024-17	17,0 cm, 6 3/4"	10025-17
10026-20	20,5 cm, 8"	10027-20



KAYE



TC		
<b>10028-14</b>	14,5 cm, 5 3/4"	<b>10029-14</b>
<b>10030-18</b>	18,5 cm, 7 1/4"	<b>10031-18</b>
<b>10032-23</b>	23,0 cm, 9"	<b>10033-23</b>
Supercut		
10034-14	14,5 cm, 5 3/4"	10035-14
10036-18	18,5 cm, 7 1/4"	10037-18
10038-23	23,0 cm, 9"	10039-23

Face-Lift-Scheren  
 Face-Lift-Scissors  
 Tijeras para Face-Lift  
 Forbici per Face-Lift

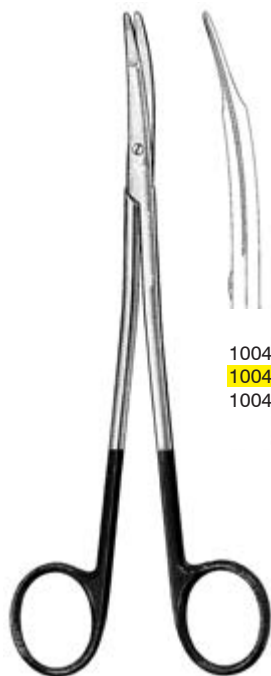

10040-18  
 10041-18 TC  
 10042-18 Supercut

FREEMAN  
 18 cm, 7"

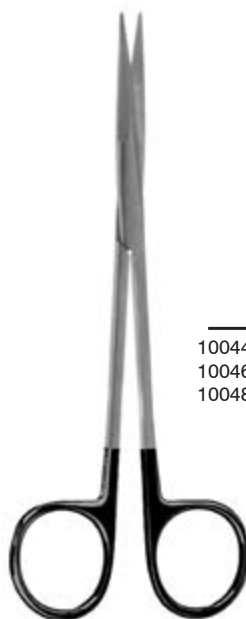

10044-14  
 10046-14 TC  
 10048-14 Supercut

10045-14  
 10047-14 TC  
 10049-14 Supercut

PECK JOSEPH  
 14,5 cm, 5 3/4"

Augenscheren  
Ophthalmic Scissors  
Tijeras oculares  
Forbici oculistiche



spitz  
pointed  
agudas  
acute

WESTCOTT  
10102-11  
11 cm, 4 3/8"



stumpf  
blunt  
romas  
smusse

WESTCOTT  
10104-11  
11 cm, 4 3/8"



spitz  
pointed  
agudas  
acute

NOYES  
10110-12 10111-12  
12 cm, 4 3/4"



WECKER  
11 cm, 4 3/8"



10113-11

spitz  
pointed  
agudas  
acute



10115-11

spitz / stumpf  
pointed / blunt  
agudas / romas  
acute / smusse



10117-11

stumpf  
blunt  
romas  
smusse

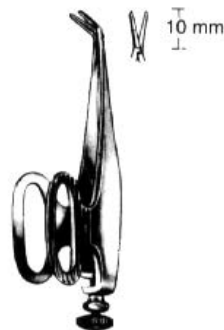

BARRAQUER  
10119-10 5,5 cm, 2.2"  
(Colibri)

Mikro-Scheren  
 Micro-Scissors  
 Micro-Tijeras  
 Micro-Forbici



10120-16  
 10120-18  
 10120-22

16,0 cm, 6 1/4"  
 18,5 cm, 7 1/4"  
 22,5 cm, 8.9"



10121-16  
 10121-18  
 10121-22



10122-16  
 10122-18  
 10122-22

16,0 cm, 6 1/4"  
 18,5 cm, 7 1/4"  
 22,5 cm, 8.9"



10123-16  
 10123-18  
 10123-22



10124-16  
 10124-18  
 10124-22

16,0 cm, 6 1/4"  
 18,5 cm, 7 1/4"  
 22,5 cm, 8.9"



10125-16  
 10125-18  
 10125-22

Circumflex

Mikro-Scheren  
Micro-Scissors  
Micro-Tijeras  
Micro-Forbici



25°

10126-25

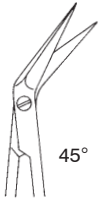

45°

10126-45

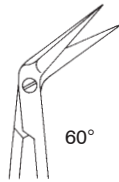

60°

10126-60



25°

10127-25

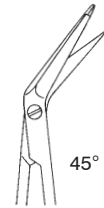

45°

10127-45

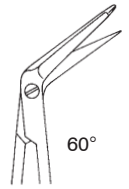

60°

10127-60

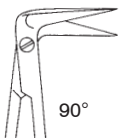

90°

10126-90

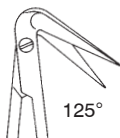

125°

10126-00

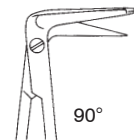

90°

10127-90

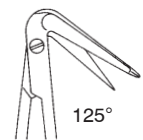

125°

10127-00



REDA  
18 cm, 7"

Mikro-Scheren  
Micro-Scissors  
Micro-Tijeras  
Micro-Forbici



10128-09  
9 cm, 3 1/2"



10128-15 - 10130-15  
15 cm, 6"

10128-15  
gerade  
straight  
rectas  
rette

10129-15  
gebogen  
curved  
curvas  
curvo

10130-15  
gebogen, 1 Schneide gezahnt  
curved, 1 blade toothed  
curvas, 1 hoja dentada  
curva, 1 lama dentellata

halbscharf  
semi-sharp  
medio roma  
lame semi smusse



HEPP-SCHEIDEL  
10131-14 14 cm, 5 1/2"  
10131-18 18 cm, 7"



HEPP-SCHEIDEL  
10132-18  
18 cm, 7"



HEPP-SCHEIDEL  
10137-01  
18 cm, 7"  
spitz  
pointed  
agudas  
acute

HEPP-SCHEIDEL  
10137-02  
18 cm, 7"  
stumpf  
blunt  
romas  
smusse



Augen-, Mikroscheren  
 Ophthalmic, Micro Scissors  
 Tijeras oculares, micro tijeras  
 Forbici oculistiche, micro chirurg.

**Iridektomie, Iridectomy, Iridectomía, iridectomia**

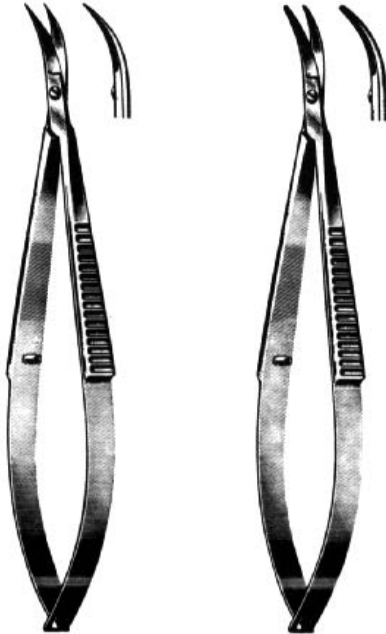

CASTROVIEJO  
 10133-10 10 cm, 4"

CASTROVIEJO  
 10135-10 10 cm, 4"



VANNAS  
 10140-08 8 cm, 3 1/8"



VANNAS  
 10141-08 8 cm, 3 1/8"



10142-08  
 kniegebogen  
 angular  
 acodada  
 angolate



10143-08  
 aufgewinkelt  
 angled up  
 acodada hacia arriba  
 angolate verso l'alto

**Hornhautscheren, Corneal scissors, Tijeras corneales, Forbici corneali**



CASTROVIEJO  
 10151-11 11 cm, 4 3/8"



CASTROVIEJO  
 10153-11 11 cm, 4 3/8"



CASTROVIEJO  
 10155-11 11 cm, 4 3/8"



Mikro-Scheren  
Micro-Scissors  
Micro-Tijeras  
Micro-Forbici



— REDA —  
10202-18 - 10203-18  
18 cm, 7"



GOMEL



10313-14  
14 cm  
5 1/2"



10313-16  
16 cm  
6 1/4"

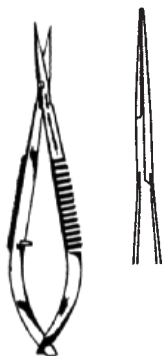

REDA micro  
10320-09  
9 cm, 3 1/2"



REDA  
10330-19 - 10333-19  
18,5 cm, 7 1/4"



10330-19



10331-19



10333-19

Anatomische und chirurgische Pinzetten  
 Dressing and Tissue Forceps  
 Pinzas de disección, sin/con dientes  
 Pinze per dissezione, chirurgiche/anatomiche

## STANDARD



USA

STILLE

cm				
10,5	4 1/4"	11102-10		
11,5	4 1/2"	11102-11		
12,0	4 3/4"			11104-12
13,0	5 1/8"	11102-13		11104-13
14,5	5 3/4"	11102-14	11103-14	11104-14
15,0	6"			11104-15
16,0	6 1/4"	11102-16		
18,0	7"	11102-18		11104-18
20,0	8"	11102-20		
21,0	8 1/4"			11104-21
25,0	10"	11102-25		11104-25
30,0	12"	11102-30		

 schmal  
 narrow  
 estrecha  
 stretta

POTTS-SMITH

 POTTS-SMITH  
 1x2

cm					
11,5	4 1/2"	11110-11			
13,0	5 1/8"	11110-13			
14,5	5 3/4"	11110-14	11114-14 TC		
16,0	6 1/4"	11110-16	11114-16 TC		
18,0	7"	11110-18		11112-18	11116-18 TC
20,0	8"	11110-20	11114-20 TC		11126-18
21,0	8 1/4"			11112-21	11116-21 TC
25,0	10"	11110-25	11114-25 TC	11112-25	11116-25 TC
30,0	12"	11110-30			11126-25

Chirurgische Pinzetten  
Tissue Forceps  
Pinzas de disección, con dientes  
Pinze per dissezione, chirurgiche

STANDARD	1x2	USA	1x2	STILLE	1x2	schmal narrow estrecha stretta
cm						
10,5	4 1/4"	11120-10				
11,5	4 1/2"	11120-11				11130-11
12,0	4 3/4"		11122-12			
13,0	5 1/8"	11120-13	11122-13			11130-13
14,5	5 3/4"	11120-14	11122-14			11130-14
15,0	6"			11124-15		
15,5	6"		11122-15			
16,0	6 1/4"	11120-16				11130-16
18,0	7"	11120-18	11122-18			11130-18
20,0	8"	11120-20				11130-20
21,0	8 1/4"		11122-21			
25,0	10"	11120-25	11122-25			
30,0	12"	11120-30				

	1x2	2x3	3x4	4x5
cm				
11,5	4 1/2"			
13,0	5 1/8"	11140-11		
14,5	5 3/4"	11140-13	11150-13	11160-13
14,5	5 3/4"	11140-14	11150-14	11160-14
16,0	6 1/4"	11140-16	11150-16	11160-16
18,0	7"	11140-18		
20,0	8"	11140-20		
25,0	10"	11140-25		
30,0	12"			

OEHLER

11132-16 TC  
11132-18 TC  
11132-20 TC  
11132-25 TC  
11132-30 TC

Anatomische und chirurgische Pinzetten  
 Dressing and Tissue Forceps  
 Pinzas de disección, sin/con dientes  
 Pinze per dissezione, chirurgiche/anatomiche



ADSON  
 11170-12 12,0 cm, 4 <sup>3</sup>/<sub>4</sub>"  
 11170-15 15,0 cm, 6"



ADSON  
 11174-12 TC 12,0 cm, 4 <sup>3</sup>/<sub>4</sub>"  
 11174-15 TC 15,0 cm, 6"



ADSON micro  
 11176-12 12,0 cm, 4 <sup>3</sup>/<sub>4</sub>"  
 11176-15 15,0 cm, 6"



ADSON-DEBAKEY atraumatic  
 11177-12  
 12,0 cm, 4 <sup>3</sup>/<sub>4</sub>"



ADSON  
 11178-12  
 12,0 cm, 4 <sup>3</sup>/<sub>4</sub>"



ADSON  
 11179-12  
 12 cm, 4 <sup>3</sup>/<sub>4</sub>"

Anatomische und chirurgische Pinzetten  
 Dressing and Tissue Forceps  
 Pinzas de disección, sin/con dientes  
 Pinze per dissezione, anatomiche/chirurgiche



1x2

ADSON

11180-12 12,0 cm, 4 3/4"  
 11180-15 15,0 cm, 6"



1x2

ADSON

11181-12 TC 12,0 cm, 4 3/4"  
 11181-15 TC 15,0 cm, 6"



1x2

ADSON micro

11186-12 12,0 cm, 4 3/4"  
 11186-15 15,0 cm, 6"



1x2

ADSON

11187-12  
 12 cm, 4 3/4"



7x7

ADSON-BROWN

11188-12 12,0 cm, 4 3/4"  
 11188-15 15,0 cm, 6"  
 11189-12 TC 12,0 cm, 4 3/4"

Anatomische und chirurgische Pinzetten  
 Dressing and Tissue Forceps  
 Pinzas de disección, sin/con dientes  
 Pinze per dissezione, chirurgice/anatomiche



9x9

**BROWN**  
 11189-15 15,0 cm, 6"  
 11189-20 20,0 cm, 8"  
 11189-25 25,0 cm, 10"



**GRAEFE**  
 11190-10 10,5 cm, 4.1"



1x2

**WAUGH**  
 11187-18 18 cm, 7"  
 11187-20 20 cm, 8"  
 11187-25 25 cm, 10"  
 11187-30 30 cm, 11 3/4"



11221-17

**CUSHING**  
 11220-17  
**11224-17 TC**  
 17,0 cm, 6 3/4"



1x2

11223-17

**CUSHING**  
 11222-17  
**11225-17 TC**  
 17,0 cm, 6 3/4"

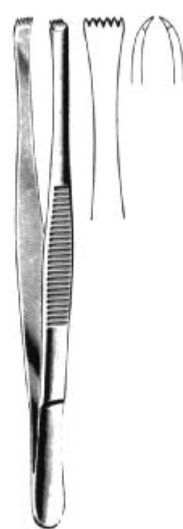

5x6

**LERCHE**  
 11232-15  
 15,0 cm, 6"

Anatomische und chirurgische Pinzetten, Faßpinzetten  
 Dressing and Tissue Forceps  
 Pinzas de disección, sin/con dientes  
 Pinze per dissezione, chirurgiche/anatomiche



BROPHY  
 11231-20  
 20,0 cm, 8"



BROPHY  
 11233-20  
 20,0 cm, 8"



BROPHY  
 20,0 cm, 8"



ADLERKREUTZ  
 11236-15 15,0 cm, 6"  
 11236-20 20,0 cm, 8"



DUEHRSEN  
 11237-20  
 20 cm, 8"



LANE  
 11240-14  
 14,5 cm, 5 3/4"



LANE  
 11242-14  
 14,5 cm, 5 3/4"



Anatomische und chirurgische Pinzetten, Faßpinzetten  
 Dressing and Tissue Forceps  
 Pinzas de disección, sin/con dientes  
 Pinze per dissezione, chirurgiche/anatomiche



FERRIS-SMITH  
 11246-18  
 18,0 cm, 7"



FERRIS-SMITH  
 11248-18  
 18,0 cm, 7"



DUVAL  
 11250-14  
 14,5 cm, 5 3/4"



COLLIN-DUVAL  
 11252-20  
 20,0 cm, 8"



Russ. Mod.  
 11256-15 15,0 cm, 6"  
 11256-20 20,0 cm, 8"  
 11256-25 25,0 cm, 10"



McINDOE  
 11257-15  
 15,0 cm, 6"



McINDOE  
 11258-15 15,0 cm, 6"  
 11259-15 TC 15,0 cm, 6"

Anatomische und chirurgische Pinzetten  
 Dressing and Tissue Forceps  
 Pinzas de disección, sin/con dientes  
 Pinze per dissezione, chirurgiche/anatomiche



SEMKEN

11260-12	12,5 cm, 5"
11260-15	15,5 cm, 6"
11261-15 TC	15,5 cm, 6"



1x2

SEMKEN

11270-12	12,5 cm, 5"
11270-15	15,5 cm, 6"
11271-15 TC	15,5 cm, 6"
11271-18 TC	18 cm, 7"



1x2

GILLIES

11272-15	15,5 cm, 6"
11273-15 TC	15,5 cm, 6"



15,5 cm, 6"

11274-06  
0,6 mm11274-08  
0,8 mm11274-10  
1,0 mm

GERALD

11302-17	17,5 cm, 6.9"
11302-23	23,0 cm, 9"
11304-17 TC	17,0 cm, 6 3/4"



GERALD

11303-17	17,5 cm, 6.9"
----------	---------------

Anatomische und chirurgische Pinzetten  
 Dressing and Tissue Forceps  
 Pinzas de disección, sin/con dientes  
 Pinze per dissezione, chirurgiche/anatomiche



GERALD  
 11305-17  
 17,5 cm, 6.9"



GERALD  
 11310-17 17,5 cm, 6.9"  
 11312-17 TC 17,5 cm, 6.9"



GERALD  
 11311-17  
 17,5 cm, 6.9"



CUSHING-TAYLOR  
 11312-18 TC  
 18,5 cm, 7 1/4"



GERALD  
 11313-17  
 17,5 cm, 6.9"



11314-01



1x2  
 11314-02

TAYLOR  
 17 cm, 6 3/4"



11315-01



1x2  
 11315-02

TAYLOR  
 17 cm, 6 3/4"

Anatomische und chirurgische Pinzetten  
 Dressing and Tissue Forceps  
 Pinzas de disección, sin/con dientes  
 Pinze per dissezione, chirurgiche/anatomiche

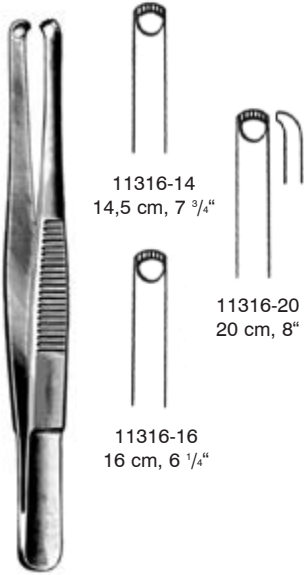

11316-14  
 14,5 cm, 7 3/4"

11316-20  
 20 cm, 8"

11316-16  
 16 cm, 6 1/4"

DURANTE

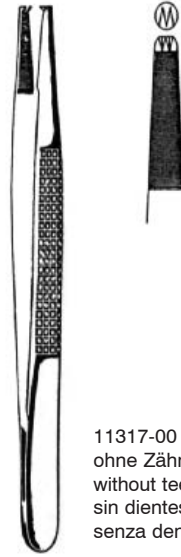

- 11317-12 1x2
- 11317-23 2x3
- 11319-12 TC 1x2

11317-00  
 ohne Zähne  
 without teeth  
 sin dientes  
 senza denti

BONNEY  
 18 cm, 7"

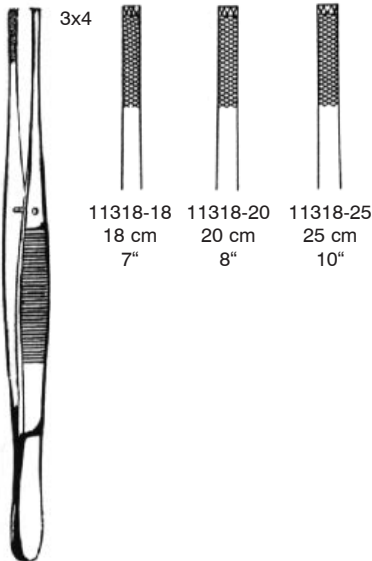

3x4

11318-18  
 18 cm  
 7"

11318-20  
 20 cm  
 8"

11318-25  
 25 cm  
 10"

STILLE-BARRAYA



OCHSNER  
 11319-14 14,5 cm 5 3/4"



SINGLEY  
 11320-18 18 cm 7"  
 11320-23 23 cm 9"

Anatomische und chirurgische Pinzetten  
 Dressing and Tissue Forceps  
 Pinzas de disección, sin/con dientes  
 Pinze per dissezione, chirurgiche/anatomiche



NELSON  
 11322-15 15 cm 6"  
 11322-18 18 cm 7"  
 11322-23 23 cm 9"



WANGENSTEEN  
 11324-23  
 23 cm 9"



11325-15 TC  
 15 cm, 6"

11325-23 TC  
 23 cm, 9"

11325-25 TC  
 25 cm, 10"

WANGENSTEEN



MAYO  
 11326-23 23 cm, 9"



STRASSBURGER  
 MODELL



1x2

11328-15  
 15 cm, 6"

1x2

11328-20  
 20 cm, 8"

Uhrmacherpinzetten  
Jeweler Type Forceps  
Pinzas de relojero  
Pinze da orologiaio

Fig. 1



11401-01  
12 cm, 4  $\frac{3}{4}$ "

Fig. 3



11403-03  
12 cm, 4  $\frac{3}{4}$ "

Fig. 3c



11403-04  
11 cm, 4  $\frac{3}{8}$ "

Fig. 4



11404-04  
11 cm, 4  $\frac{3}{8}$ "

Fig. 5



11405-05  
11 cm, 4  $\frac{3}{8}$ "

Fig. 7



11407-07  
12 cm, 4  $\frac{3}{4}$ "

Splitterpinzetten  
Splinter Forceps  
Pinzas para espinas  
Pinze per schegge



11802-09 9,0 cm, 3 1/2"  
11802-10 10,5 cm, 4.1"  
11802-11 11,5 cm, 4 1/2"



FEILCHENFELD  
11810-07 7,5 cm, 3"  
11810-09 9,0 cm, 3 1/2"  
11810-11 11,5 cm, 4 1/2"



HUNTER  
11812-10 10,5 cm, 4.1"



HUNTER  
11813-10  
10,5 cm, 4.1"



HUNTER  
11815-12  
12,5 cm, 5"



CARMALT  
11816-10  
10,5 cm, 4.1"



CARMALT  
11817-10  
10,5 cm, 4.1"

Splitterzangen  
 Splinter Forceps  
 Pinzas para espinas  
 Pinze per schegge



PEET  
 11821-11  
 11,5 cm, 4 1/2"

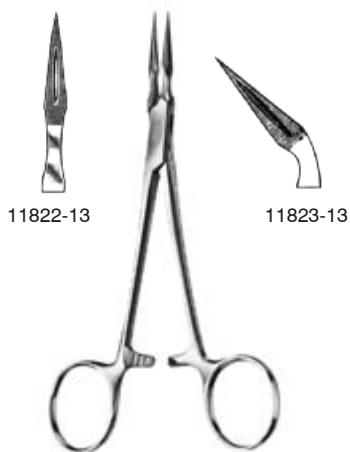

STIEGLITZ  
 11822-13  
 11823-13  
 13,5 cm, 5 1/4"

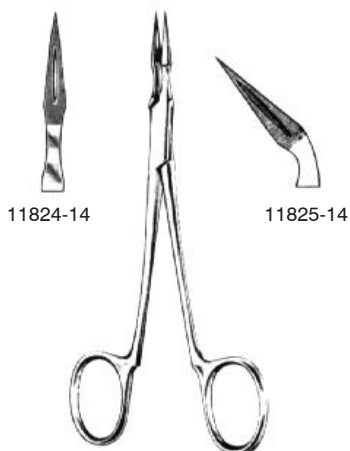

ARCHER  
 11824-14  
 11825-14  
 14 cm, 5 1/2"



VIRTUS (RALK)  
 11828-15  
 15 cm, 6"



Zahnpinzetten  
Dental Forceps  
Pinzas dentales  
Pinze dentali

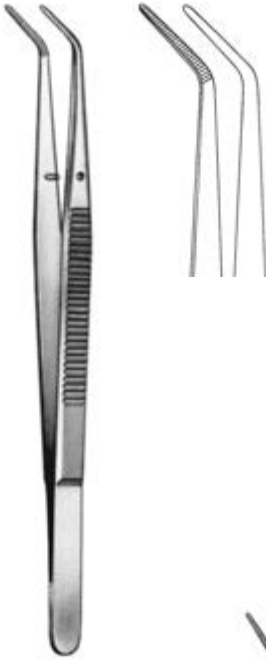

LONDON-COLLEGE  
11900-01  
15 cm, 6"



LONDON-COLLEGE  
11901-05  
15 cm, 6"

mit Sperre  
with lock  
con cierre  
con fermo



MERIAM  
11910-01  
15 cm, 6"

Mikrochirurgie-Pinzetten  
Microsurgery Forceps  
Pinzas para microcirugía  
Pinze per microchirurgia



12102-12  
12 cm, 4 3/4"



12103-12  
12 cm, 4 3/4"



12104-15  
15 cm, 6"



12105-15  
15 cm, 6"



12108-18  
18 cm, 7"



12109-18  
18 cm, 7"

Ultra-Light-Pinzetten  
Ultra-Light-Forceps  
Pinzas-Ultra-Ligera  
Pinza-ultra-leggera

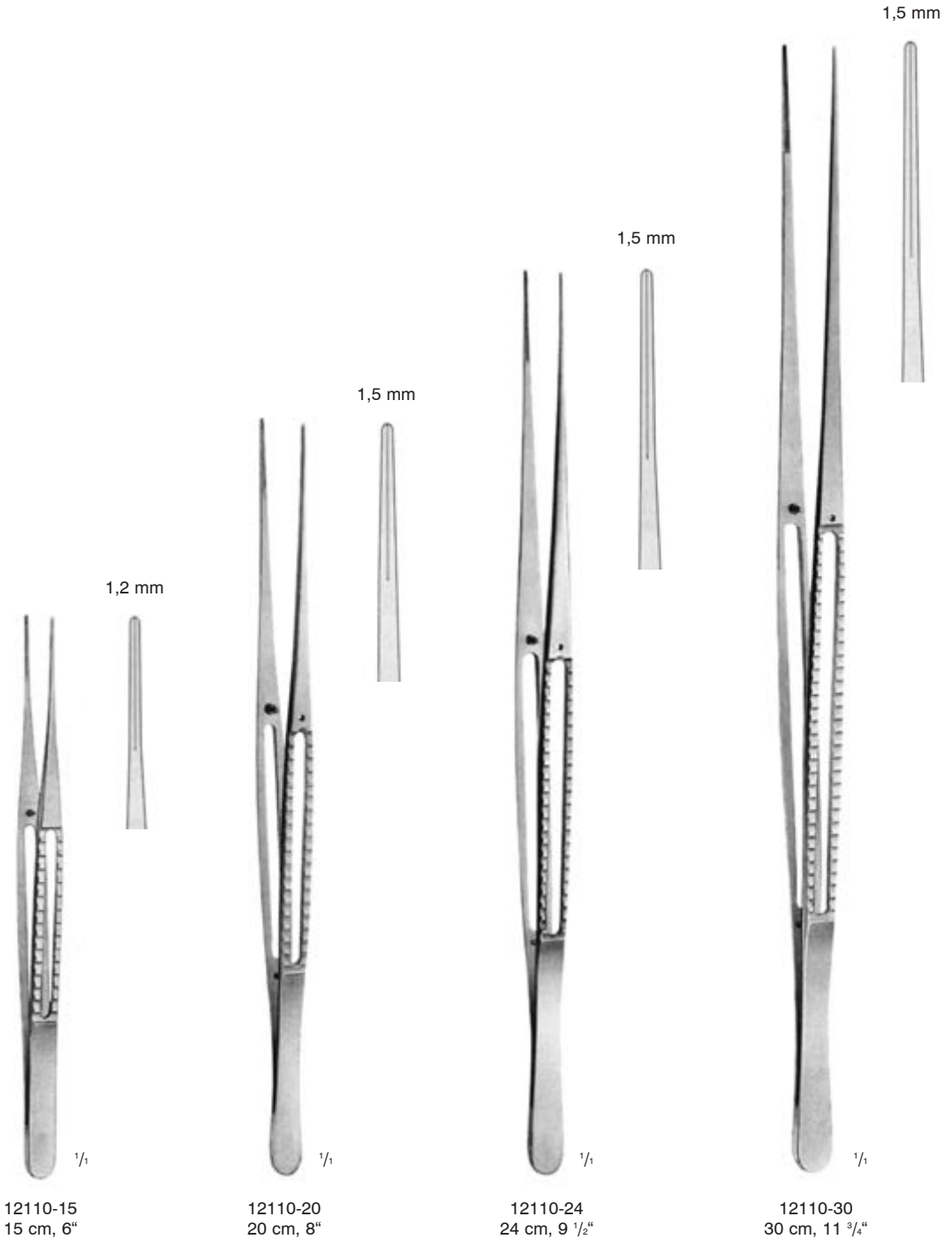

Mikrochirurgie-Pinzetten  
Microsurgery Forceps  
Pinzas para microcirugía  
Pinze per microchirurgia

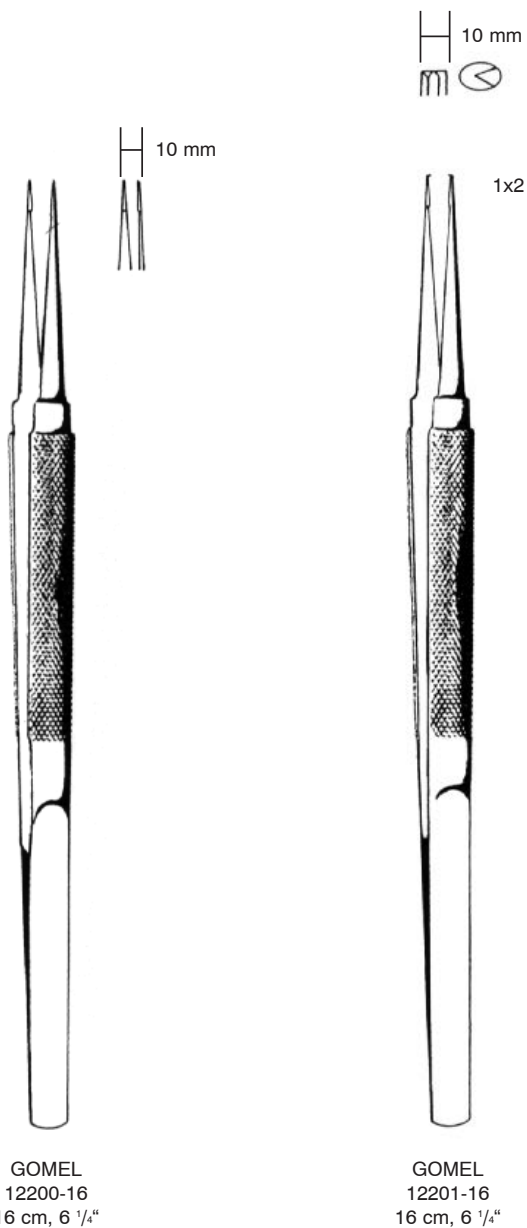

Tumorpinzetten  
Tumor forceps  
Pinzas para tumores  
Pinze per tumori



12291-22  
ø 3 mm



12293-22  
ø 5 mm



YASARGIL  
12295-22  
ø 3 mm



HUNT  
12297-22  
ø 5 mm

YASARGIL  
22 cm, 8 <sup>3</sup>/<sub>4</sub>"

22 cm, 8 <sup>3</sup>/<sub>4</sub>"

Atraumatische Pinzetten  
Atraumatic Tissue Forceps  
Pinzas atraumáticas  
Pinze atraumatiche



1 mm

## DE BAKEY

12302-16 16 cm, 6 1/4"  
12302-20 20 cm, 8"  
12302-24 24 cm, 9 1/2"



1,5 mm

## DE BAKEY

12306-16 16 cm, 6 1/4"  
12306-20 20 cm, 8"  
12306-24 24 cm, 9 1/2"  
12306-30 30 cm, 11 3/4"



2,0 mm

## DE BAKEY

12308-16 16 cm, 6 1/4"  
12308-20 20 cm, 8"  
12308-24 24 cm, 9 1/2"  
12308-30 30 cm, 11 3/4"



2,0 mm

## DE BAKEY

12309-16 16 cm, 6 1/4"  
12309-20 20 cm, 8"  
12309-24 24 cm, 9 1/2"  
12309-30 30 cm, 11 3/4"



2,7 mm

## DE BAKEY

12304-16 16 cm, 6 1/4"  
12304-20 20 cm, 8"  
12304-24 24 cm, 9 1/2"  
12304-30 30 cm, 11 3/4"

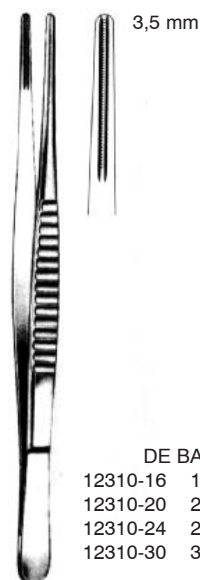

3,5 mm

## DE BAKEY

12310-16 16 cm, 6 1/4"  
12310-20 20 cm, 8"  
12310-24 24 cm, 9 1/2"  
12310-30 30 cm, 11 3/4"

Atraumatische Pinzetten  
 Atraumatic Tissue Forceps  
 Pinzas atraumáticas  
 Pinze atraumatiche

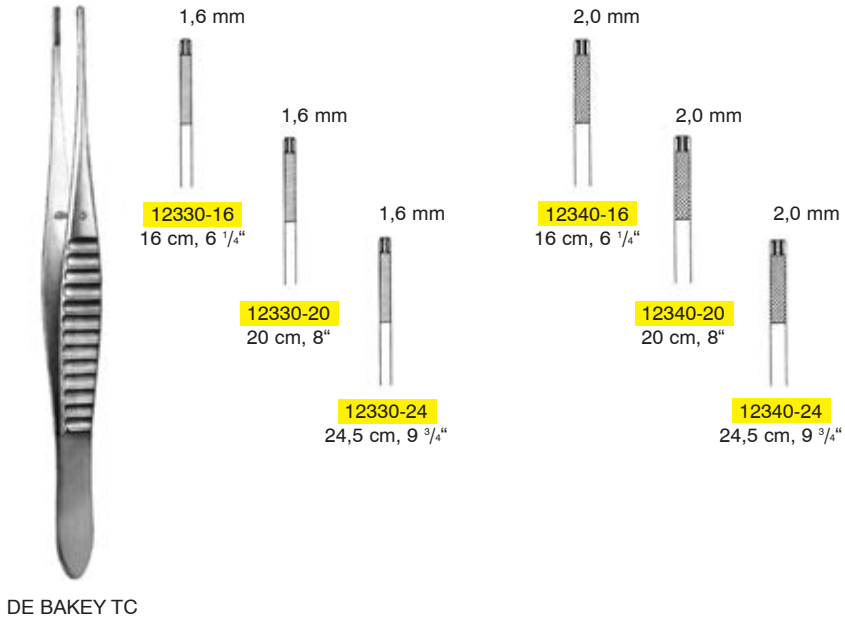
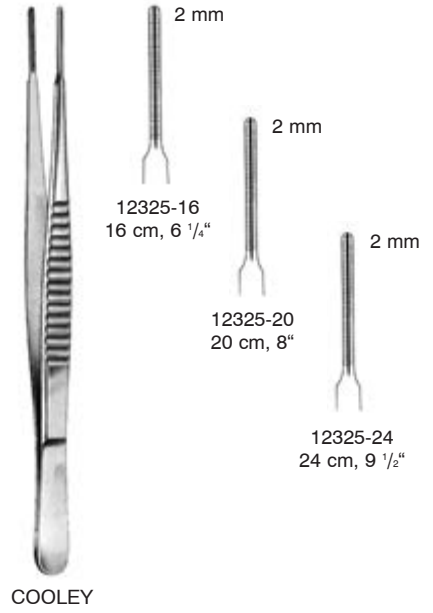
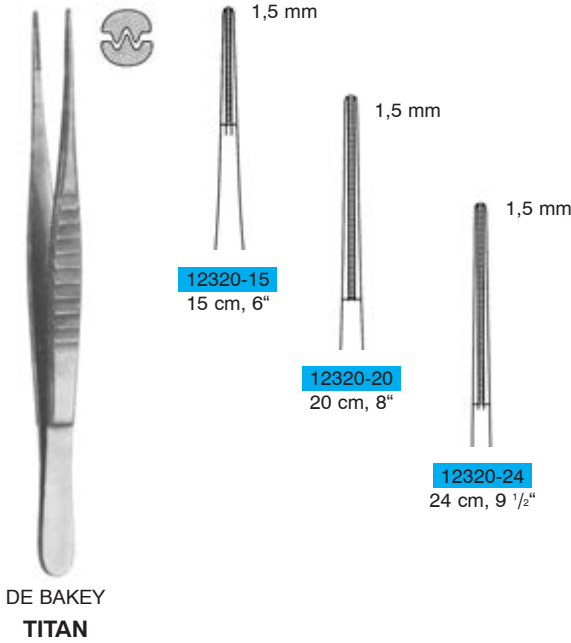

Atrauma-Bulldogklemmen  
 Atrauma-Bulldog Clamps  
 Clamps Atrauma Bulldog  
 Pinze Atrauma Bulldog



13090-40  
 40 mm / 1 1/2"

13090-45  
 45 mm / 1 3/4"

13090-50  
 50 mm / 2"



13091-40  
 40 mm / 1 1/2"

13091-45  
 45 mm / 1 3/4"

13091-50  
 50 mm / 2"

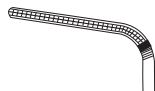

GLOVER  
 13098-06  
 57 mm / 2 3/8"

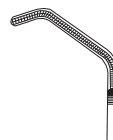

DE BAKEY  
 13099-07  
 73 mm / 2 3/4"



Mini-Bulldogklemmen  
 Mini Bulldog Clamps  
 Clamps Bulldog Mini  
 Pinze Bulldog Mini

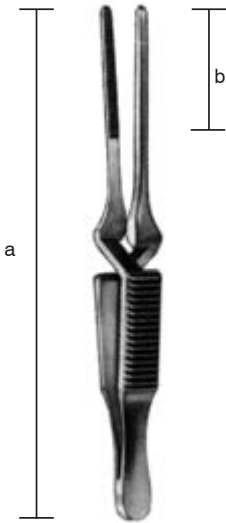

DIETHRICH

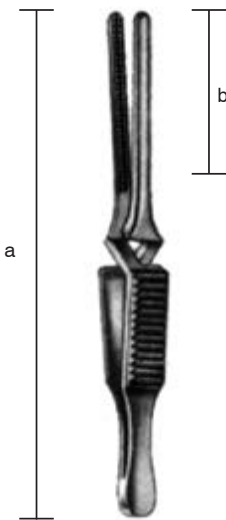
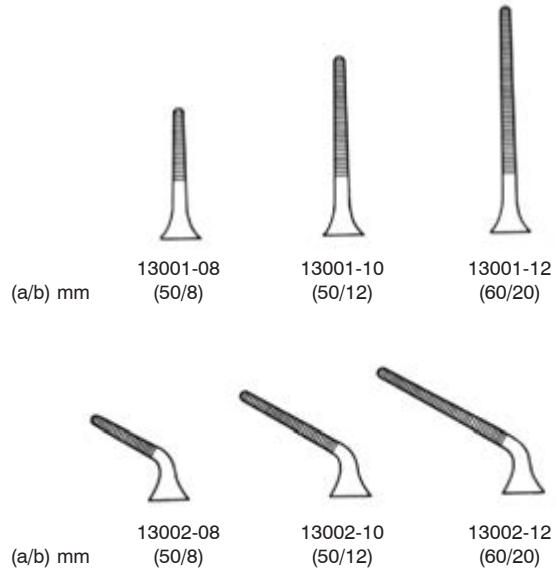

DEBAKEY-DIETHRICH

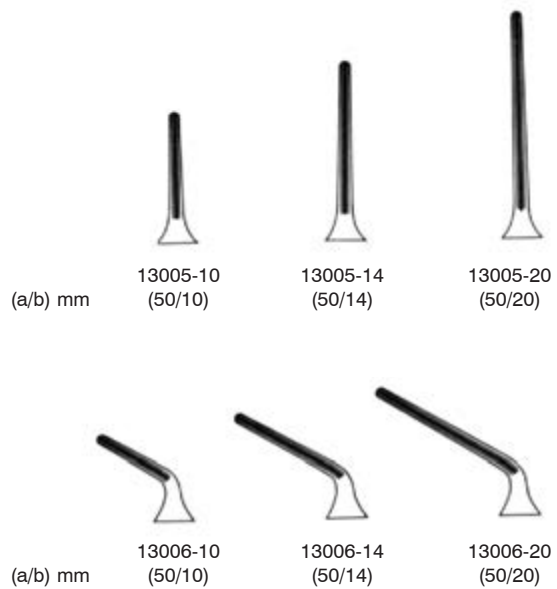

Titan-Atrauma-Bulldogklemmen  
 Titanium Atrauma Bulldog Clamps  
 Titan Clamp Bulldog  
 Titan Pinze Bulldog

	3 cm, 1.2"	3,5 cm, 1.4"	4 cm, 1 1/2"	5 cm, 2"
Vene	13010-30	13010-35	13010-40	13010-50
Arterie	13011-30	13011-35	13011-40	13011-50

	3 cm, 1.2"	3,5 cm, 1.4"	4 cm, 1 1/2"	5 cm, 2"
Vena	13012-30	13012-35	13012-40	13012-50
Arteria	13013-30	13013-35	13013-40	13013-50

	3 cm, 1.2"	3,5 cm, 1.4"	4 cm, 1 1/2"	5 cm, 2"
Vene	13014-30	13014-35	13014-40	13014-50
Arterie	13015-30	13015-35	13015-40	13015-50

Atrauma-Bulldogklemmen  
 Atrauma Bulldog Clamps  
 Clamps Atrauma Bulldog  
 Pinze Atrauma Bulldog



DE BAKEY

 13092-07  
 7,5 cm  
 3"

 13092-08  
 8,5 cm  
 3.4"

 13092-10  
 10,5 cm  
 4"

 13092-12  
 12 cm  
 4 3/4"

 13093-07  
 7 cm  
 2 3/4"

 13093-08  
 8 cm  
 3 1/8"

 13093-10  
 10 cm  
 4"

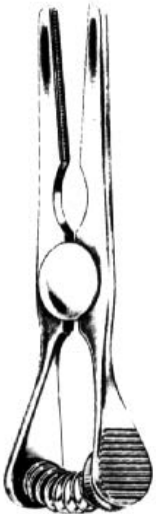
 13093-12  
 11,5 cm  
 4 1/2"

GLOVER

 13096-06  
 6 cm  
 2 1/4"

 13096-07  
 7 cm  
 2 3/4"

 13096-09  
 9 cm  
 3 1/2"

 13096-11  
 11 cm  
 4 3/8"

 13097-06  
 5,5 cm  
 2"

 13097-07  
 6,5 cm  
 2 1/2"

 13097-09  
 8,5 cm  
 3 1/4"

 13097-11  
 10,5 cm  
 4"

Gefäßklemmen, Bulldogklemmen, Arterienklemmen  
 Hemostatic Forceps  
 Pinzas hemostáticas  
 Pinze serraфина, Pinze emostatiche



DIEFFENBACH  
 13102-04 3,5 cm, 1.4"  
 13102-05 5,5 cm, 2.2"



DIEFFENBACH  
 13103-04 3,5 cm, 1.4"  
 13103-05 5,5 cm, 2.2"

gerade  
 straight  
 recta  
 rette



gebogen  
 curved  
 curva  
 curve

JOHNS-HOPKINS

13110-50	5,0 cm, 2"	13111-50
13110-55	5,5 cm, 2.2"	13111-55
13110-65	6,5 cm, 2.6"	13111-65
13110-70	7,0 cm, 2 3/4"	13111-70
13110-75	7,5 cm, 3"	13111-75
13110-90	9,0 cm, 3 1/2"	13111-90

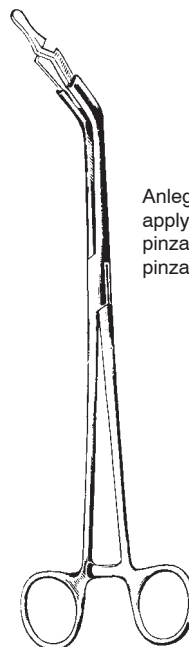

Anlegezange  
 applying forceps  
 pinza para poner  
 pinza applicatrice

13115-00  
 23 cm, 9"

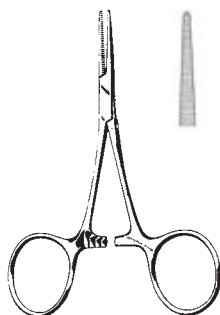

HARTMANN  
 13210-10  
 10 cm, 4"

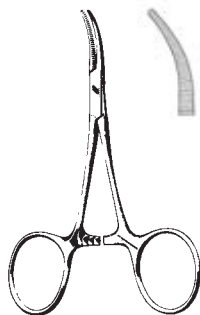

HARTMANN  
 13211-10  
 10 cm, 4"

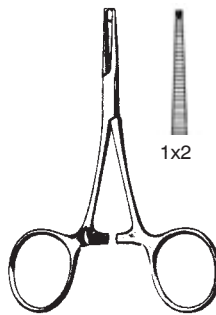

HARTMANN  
 13212-10  
 10 cm, 4"

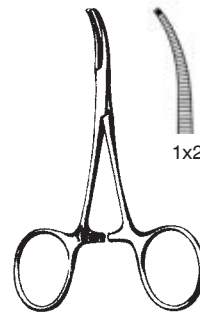

HARTMANN  
 13213-10  
 10 cm, 4"

Micro-HARTMANN  
 13214-10  
 10 cm, 4"

Micro-HARTMANN  
 13215-10  
 10 cm, 4"

Arterienklemmen  
Hemostatic Forceps  
Pinzas hemostáticas  
Pinze emostatiche



TITAN — HALSTED-MOSQUITO — TITAN  
**13224-12** 13220-12 12,5 cm, 5" 13221-12 **13225-12**  
 13220-14 14,0 cm, 5 1/2" 13221-14  
 13220-18 18,0 cm, 7" 13221-18  
 13220-21 21,0 cm, 8 1/4" 13221-21



— HALSTED-MOSQUITO micro —  
 13222-12 12,5 cm, 5" 13223-12  
 JACOBSON micro  
 13226-12 12,0 cm, 4 3/4" 13227-12

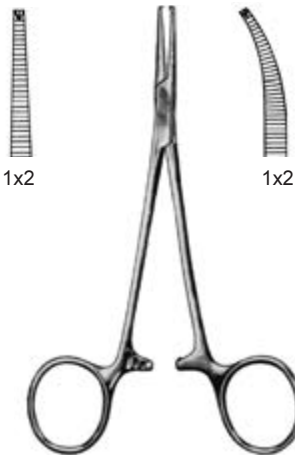

— HALSTED-MOSQUITO —  
 13230-12 12,5 cm, 5" 13231-12  
 13230-14 14,0 cm, 5 1/2" 13231-14  
 13230-18 18,0 cm, 7" 13231-18  
 13230-21 21,0 cm, 8 1/4" 13231-21

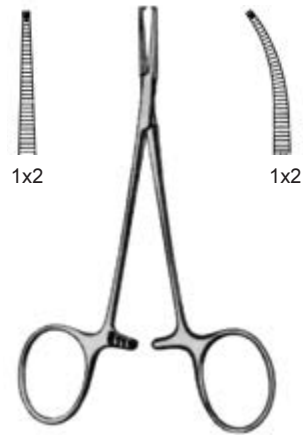

— HALSTED-MOSQUITO micro —  
 13232-12 13233-12

Arterienklemmen  
Hemostatic Forceps  
Pinzas hemostáticas  
Pinze emostatiche

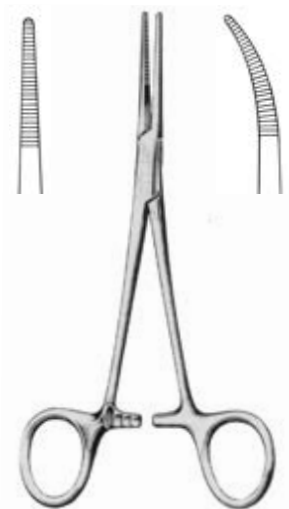

KELLY

13240-14	14 cm, 5 1/2"	13241-14
13240-18	18 cm, 7"	13241-18
13244-14	14 cm, 5 1/2"	13245-14
TITAN		TITAN

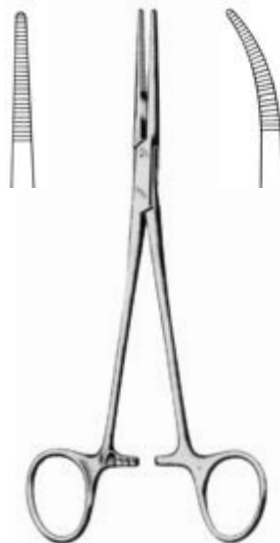

KELLY-RANKIN

13242-16	16 cm, 6 1/4"	13243-16
----------	---------------	----------

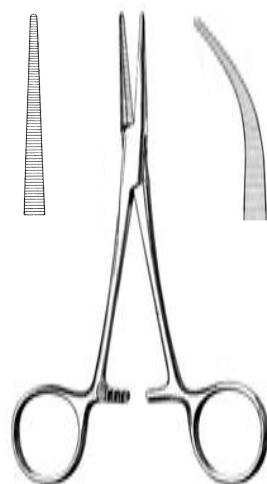

COLLER-CRILE

13256-14	14 cm, 5 1/2"	13257-14
13258-16	16 cm, 6 1/4"	13259-16

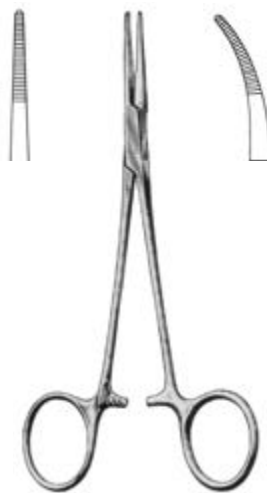

PROVIDENCE-HOSPITAL

13270-14	14 cm, 5 1/2"	13271-14
----------	---------------	----------

Arterienklemmen  
 Hemostatic Forceps  
 Pinzas hemostáticas  
 Pinze emostatiche



CRILE  
 13250-14 14 cm, 5 1/2" 13251-14  
 13250-18 18 cm, 7" 13251-18  
 13254-14 14 cm, 5 1/2" 13255-14  
 TITAN TITAN

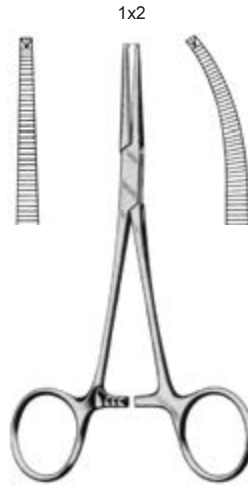

CRILE  
 13260-14 14 cm, 5 1/2" 13261-14



CRILE-RANKIN  
 13262-16 16 cm, 6 1/4" 13263-16

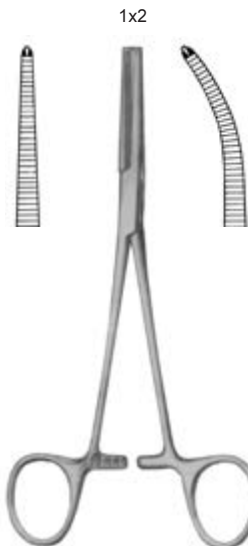

CRILE-RANKIN  
 13264-16 16 cm, 6 1/4" 13265-16

Arterienklemmen  
Hemostatic Forceps  
Pinzas hemostáticas  
Pinze emostatiche

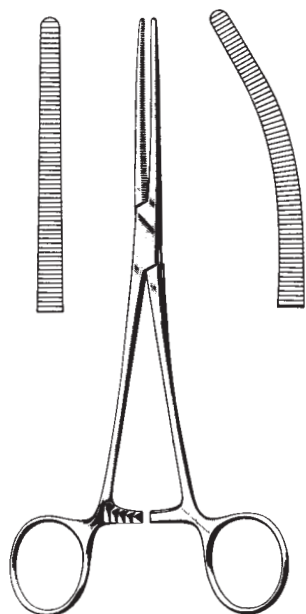

ROCHESTER-PEAN

13310-13	13 cm, 5 1/8"	13311-13
13310-14	14 cm, 5 1/2"	13311-14
13310-16	16 cm, 6 1/4"	13311-16
13310-18	18 cm, 7"	13311-18
13310-20	20 cm, 8"	13311-20
13310-22	22 cm, 8 3/4"	13311-22
13310-24	24 cm, 9 1/2"	13311-24
13310-26	26 cm, 10 1/4"	13311-26
13310-30	30 cm, 11 3/4"	13311-30

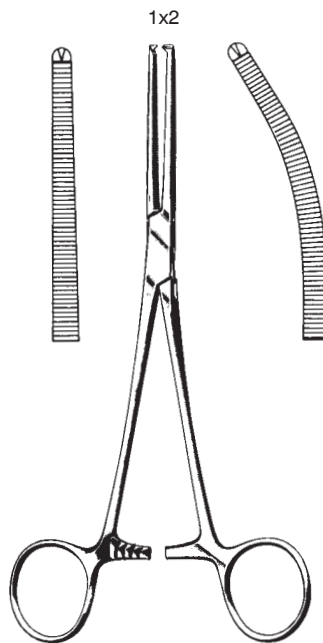

ROCHESTER-OGHSNER

13320-13	13 cm, 5 1/8"	13321-13
13320-14	14 cm, 5 1/2"	13321-14
13320-16	16 cm, 6 1/4"	13321-16
13320-18	18 cm, 7"	13321-18
13320-20	20 cm, 8"	13321-20
13320-22	22 cm, 8 3/4"	13321-22
13320-24	24 cm, 9 1/2"	13321-24
13320-26	26 cm, 10 1/4"	13321-26
13320-30	30 cm, 11 3/4"	13321-30

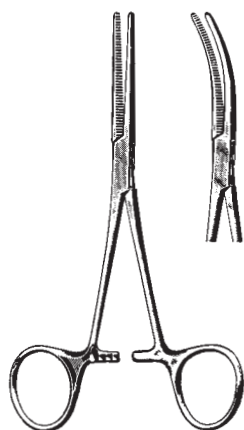

Fein  
Delicate  
Delicada  
Fina

PEAN

13312-14	14 cm, 5 1/2"	13313-14
13312-16	16 cm, 6 1/4"	13313-16

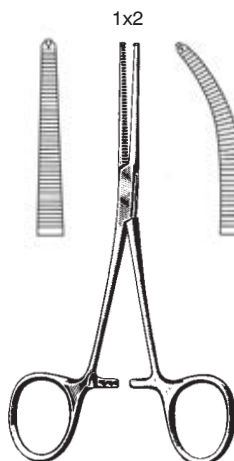

Fein  
Delicate  
Delicada  
Fina

KOCHER

13322-14	14 cm, 5 1/2"	13323-14
13322-16	16 cm, 6 1/4"	13323-16



Arterienklemmen  
Hemostatic Forceps  
Pinzas hemostáticas  
Pinze emostatiche



SPENCER-WELLS

13330-13	13 cm, 5"	13331-13
13330-15	15 cm, 6"	13331-15
13330-18	18 cm, 7"	13331-18
13330-20	20 cm, 8"	13331-20

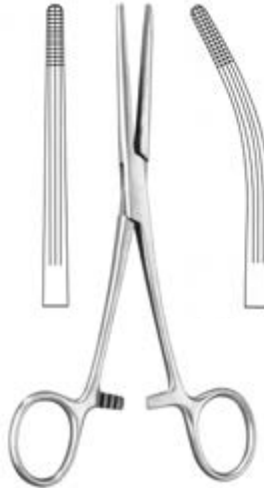

ROCHESTER-CARMALT

13340-16	16 cm, 6 1/4"	13341-16
13340-20	20 cm, 8"	13341-20

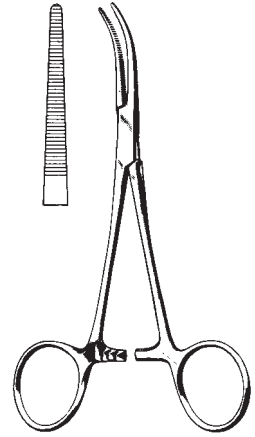

DANDY

13345-12	12 cm, 4 3/4"
13345-14	14 cm, 5 1/2"

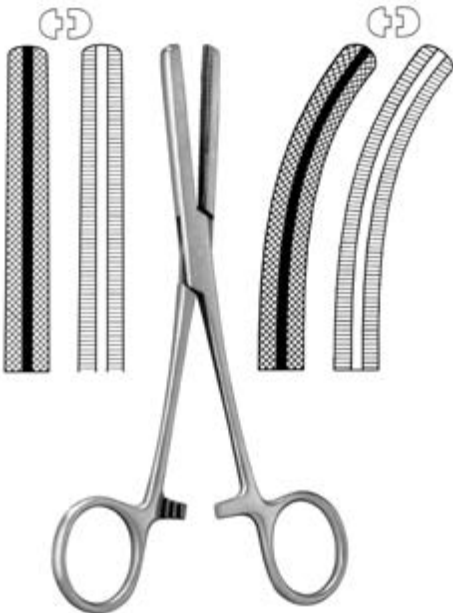

FERGUSSON

13350-16	16 cm, 6 1/4"	13351-16
13350-20	20 cm, 8"	13351-20

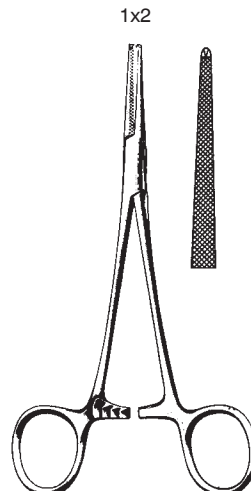

LOVELACE

13356-15	15,5 cm, 6"
----------	-------------



PENNINGTON

13358-15	15,5 cm, 6"
13358-20	20,0 cm, 8"

Fasszangen  
Grasping Forceps  
Pinza para agarrar órganos y tejidos  
Pinze da presa



PRATT  
13360-15 15 cm, 6"

MARTEL  
13364-14 14 cm, 5 1/2"

WILLET MARTEL  
13366-19 19 cm, 7 1/2"

PEAN  
13368-14 14 cm, 5 1/2"  
13368-16 16 cm, 6 1/4"



3x2  
CHAPUT  
13370-13  
13 cm, 5 1/8"

5x6  
TUFFIER  
13372-13  
13 cm, 5 1/8"

COLLIN  
13374-14  
14 cm, 5 1/2"

COLLIN  
13376-16  
16 cm, 6 1/4"

Organ- und Gewebefasszange, Arterienklemmen  
 Organ- and Tissue Grasping Forceps, Hemostatic Forceps  
 Pinza para agarrar órganos y tejidos, Pinzas hemostáticas  
 Pinza per tessuti e organi, Pinze emostatiche



REDA  
 Atrauma  
 13377-25 - 13377-26



13377-25  
 25 cm, 10"

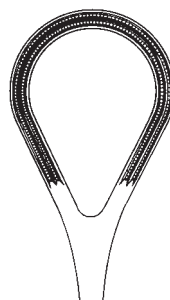

13377-26  
 26 cm, 10 1/4"



LERICHE  
 13380-15 15 cm, 6" 13381-15

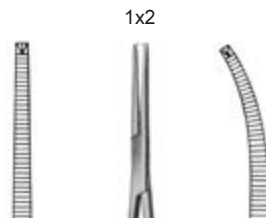

LERICHE  
 13382-15 15 cm, 6" 13383-15

Arterienklemmen  
 Hemostatic Forceps  
 Pinzas hemostáticas  
 Pinze emostatiche

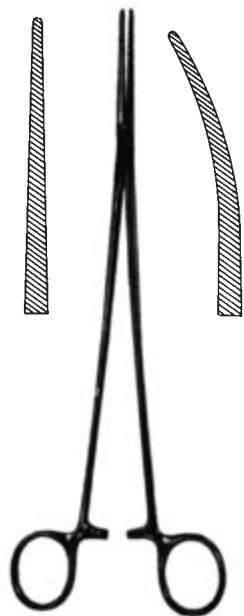

— BENGOLEA —  
 13384-20 20 cm, 8" 13385-20  
 13384-26 26 cm, 10 1/4" 13385-26

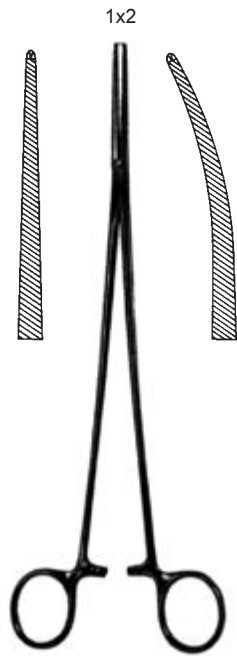

— BENGOLEA —  
 13386-20 20 cm, 8" 13387-20  
 13386-26 26 cm, 10 1/4" 13387-26

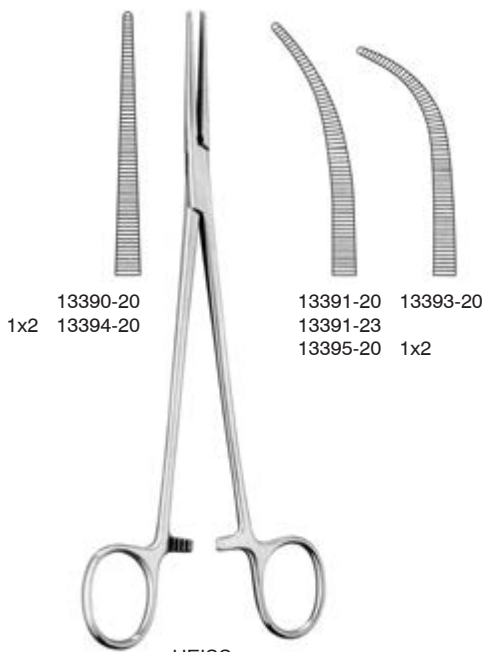

13390-20  
 1x2 13394-20  
 13391-20 13393-20  
 13391-23  
 13395-20 1x2

HEISS  
 20 cm, 8"

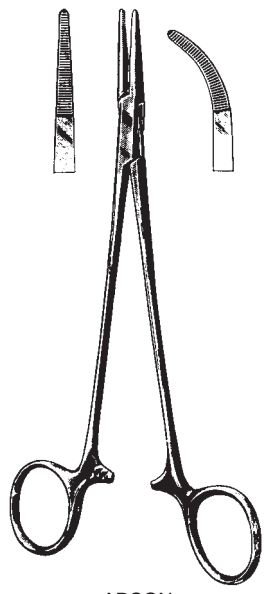

— ADSON —  
 13410-18 18,5 cm, 7 1/4" 13411-18

Arterienklemmen  
Hemostatic Forceps  
Pinzas hemostáticas  
Pinze emostatiche

1x2

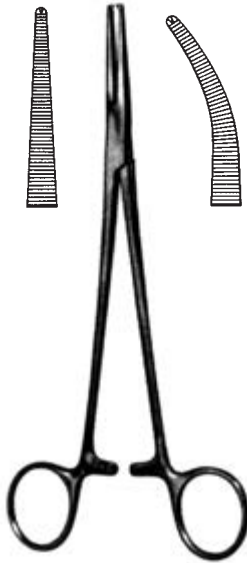

ADSON  
13412-18 18,5 cm, 7 1/4" 13413-18



FUCHSIG  
13414-20 19 cm, 7 1/2"



ADSON BABY  
13415-14 14,0 cm, 5 1/2"  
13415-18 18,5 cm, 7 1/4"



NISSEN  
13416-18 18,5 cm, 7 1/4"

Arterienklemmen  
 Hemostatic Forceps  
 Pinzas hemostáticas  
 Pinze emostatiche



OVERHOLT-BABY  
 13420-14  
 14 cm, 5 1/2"



OVERHOLT-GEISSENDOERFER  
 21 cm, 8 1/4"

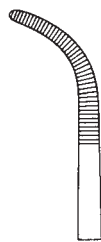

Fig. 1  
 13421-01

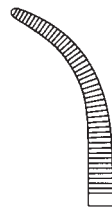

Fig. 2  
 13421-02  
 13425-02  
 26 cm  
 10 1/4"

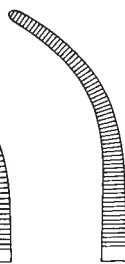

Fig. 3  
 13421-03  
 13425-03  
 27 cm  
 10 1/2"

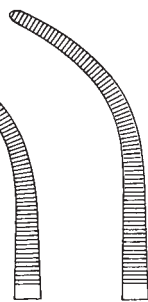

Fig. 4  
 13421-04  
 13425-04  
 27,5 cm  
 10,8"



Fig. 5  
 13421-05  
 13425-05  
 27 cm  
 10 1/2"



Fig. 6  
 13421-06  
 13425-06  
 28 cm  
 11"

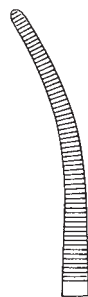

Fig. 7  
 13421-07



OVERHOLT



13422-00  
 21,5 cm  
 8 1/2"  
 Fig. 0



13422-01  
 21 cm  
 8 1/4"  
 Fig. 1



13422-02  
 22 cm  
 8 3/4"  
 Fig. 2



13422-03  
 23 cm  
 9"  
 Fig. 3



13422-06  
 22,5 cm  
 8,9"  
 Fig. 6

Arterienklemmen  
 Hemostatic Forceps  
 Pinzas hemostáticas  
 Pinze emostatiche



OVERHOLT-MIXTER  
 13428-21  
 21,5 cm, 8 1/2"



GEMINI



13431-13  
 13 cm  
 5 1/8"

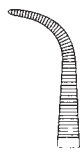

13431-16  
 16 cm  
 6 1/4"

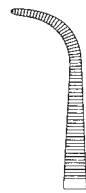

13431-18  
 18 cm  
 7"

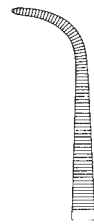

13431-20  
 20 cm  
 8"

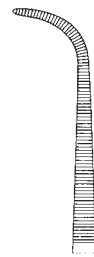

13431-23  
 23 cm  
 9"



13431-25  
 25 cm  
 10"

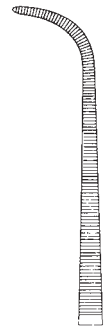

13431-28  
 28 cm  
 11"

Arterienklemmen  
 Hemostatic Forceps  
 Pinzas hemostáticas  
 Pinze emostatiche

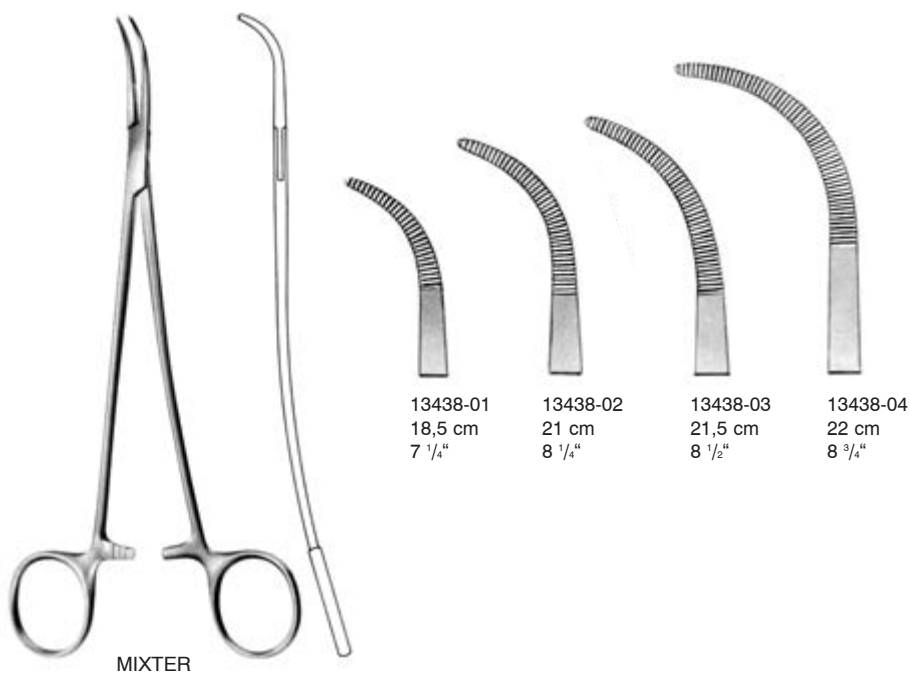



Arterienklemmen  
Hemostatic Forceps  
Pinzas hemostáticas  
Pinze emostatiche

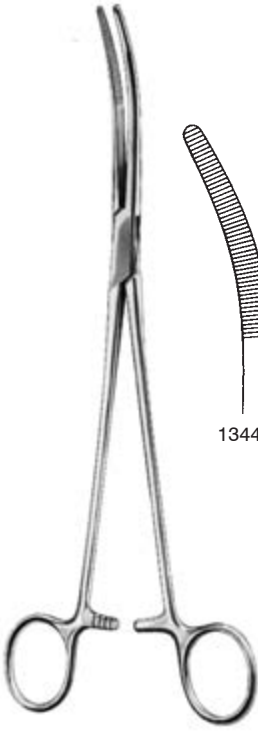

RUMEL  
23 cm, 9"

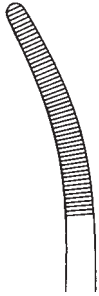

13441-01

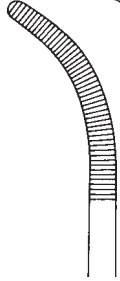

13441-02



13441-03

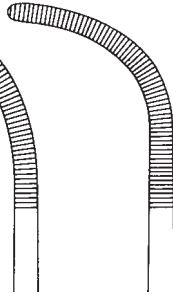

13441-04



WIKSTROEM  
13447-20  
20,5 cm, 8"

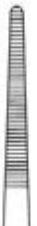

13442-21 21 cm, 8 1/4"  
13442-26 26 cm, 10 1/4"

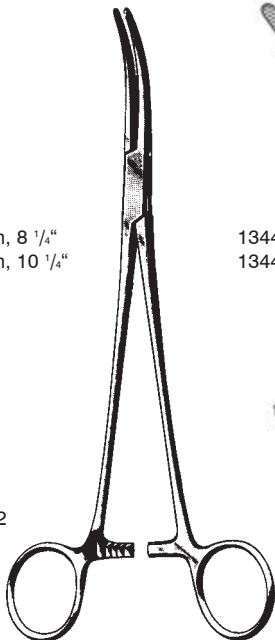

TOENNIS



13443-21 21 cm, 8 1/4"  
13443-26 26 cm, 10 1/4"



13445-21 21 cm, 8 1/4"  
13445-26 26 cm, 10 1/4"

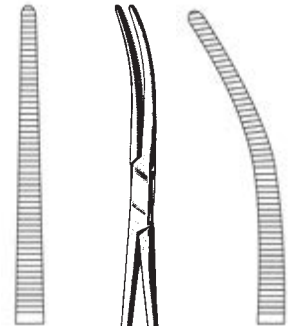

ROBERTS  
13448-22 22 cm, 8 3/4" 13449-22

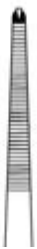

13444-21 21 cm, 8 1/4"  
13444-26 26 cm, 10 1/4"

1x2

1x2

Arterienklemmen  
 Hemostatic Forceps  
 Pinzas hemostáticas  
 Pinze emostatiche



CRAFOORD  
 13453-18 18 cm, 7"  
 13453-24 24 cm, 9 1/2"



SAROT  
 13450-24 24 cm, 9 1/2" 13451-24



13455-01



ZENKER  
 29,5 cm, 11 1/2"

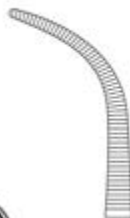

13455-02

Arterienklemmen  
Hemostatic Forceps  
Pinzas hemostáticas  
Pinze emostatiche

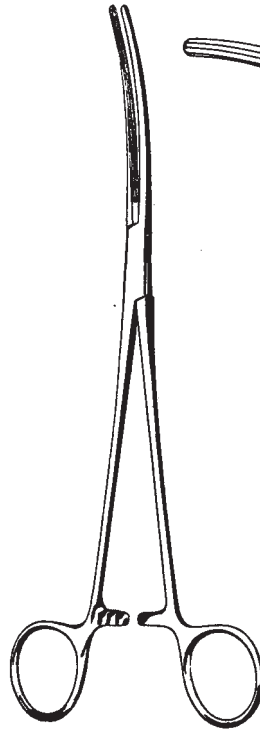

CRAFOORD-SELLORS  
24 cm, 9 1/2"

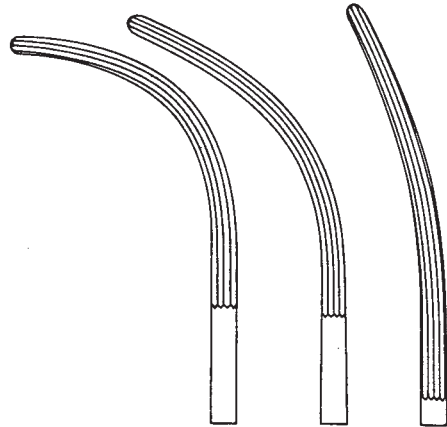

13456-01 13456-02 13456-03



LAWRENCE  
13457-28 28 cm, 11"



MEEKER  
13459-18 18 cm, 7"  
13459-28 28 cm, 11"

Arterienklemmen  
Hemostatic Forceps  
Pinzas hemostáticas  
Pinze emostatiche

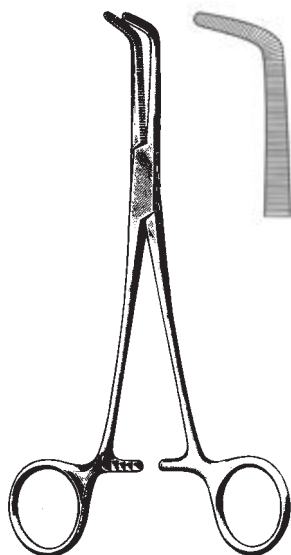

MIXTER

13471-14 14 cm, 5 1/2"  
13471-16 16 cm, 6 1/4"  
13471-18 18 cm, 7"  
13471-23 23 cm, 9"



MIXTER

13473-22  
22 cm, 8 3/4"



KANTROWITZ

13474-19 19 cm, 7 1/2"  
13474-24 24 cm, 9 1/2"  
13474-26 26 cm, 10 1/4"



MIXTER BABY

13475-14  
14 cm, 5 1/2"

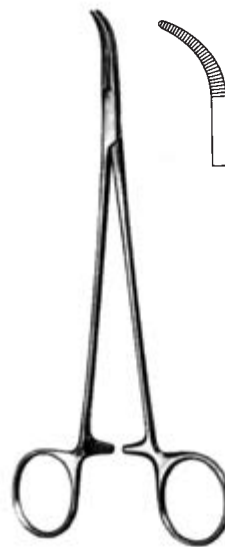

MIXTER BABY

13475-18  
18 cm, 7"

Arterienklemmen  
 Hemostatic Forceps  
 Pinzas hemostáticas  
 Pinze emostatiche

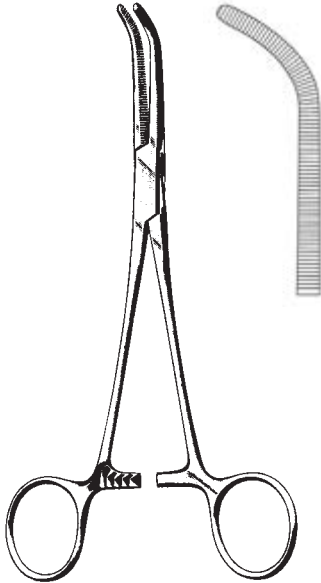

MIXTER-O'SHAUGNESSY  
 13477-15 15,5 cm, 6"  
 13477-19 19,0 cm, 7 1/2"

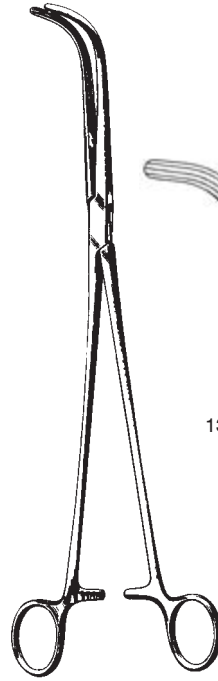

MIXTER

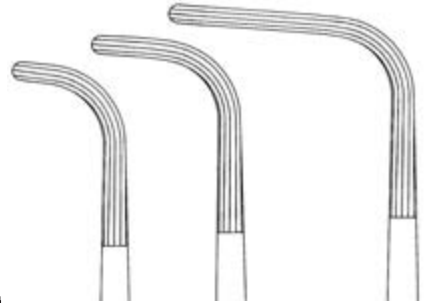

13479-22	13479-25	13479-28
22 cm	25 cm	28 cm
8 3/4"	10"	11"

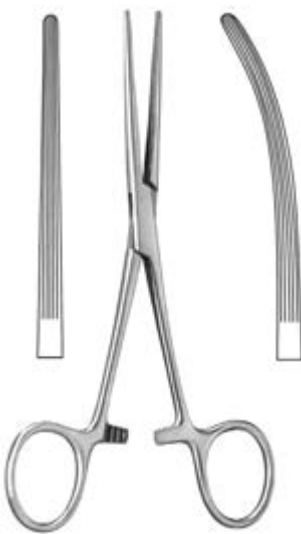

BAINBRIDGE  
 13480-15 15,0 cm, 6" 13481-15  
 13480-18 18,5 cm, 7 1/4" 13481-18

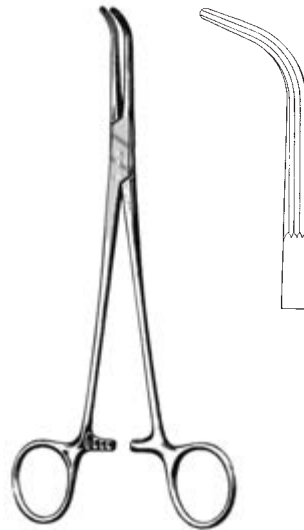

LAHEY  
 13491-19 19 cm, 7 1/2"

Arterienklemmen  
Hemostatic Forceps  
Pinzas hemostáticas  
Pinze emostatiche



LAHEY  
13493-23 23 cm, 9"



LOWER  
13495-18 18 cm, 7"

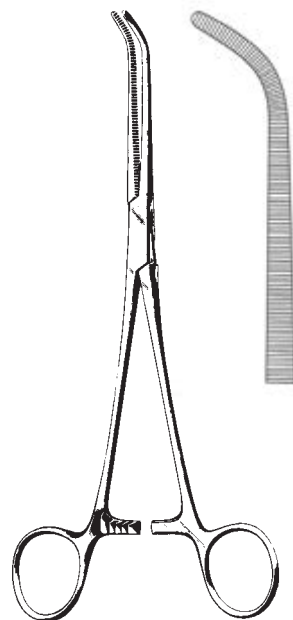

JOHNS-HOPKINS  
13497-20 20 cm, 8"

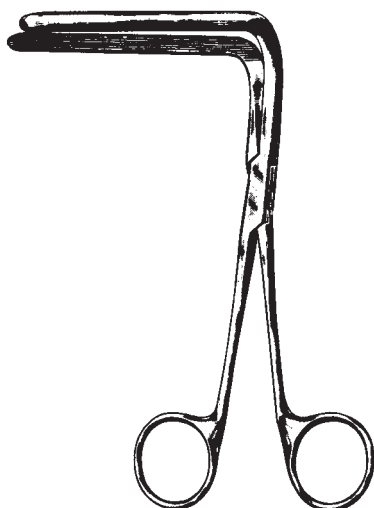

MIXTER  
13499-16  
16,5 cm, 6 1/2"

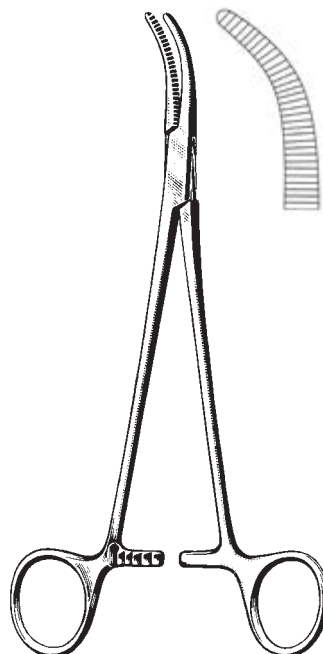

MOYNIHAN  
13501-23  
23 cm, 9"

Arterienklemmen  
Hemostatic Forceps  
Pinzas hemostáticas  
Pinze emostatiche



DESJARDINS  
13503-21 21 cm, 8 1/4"

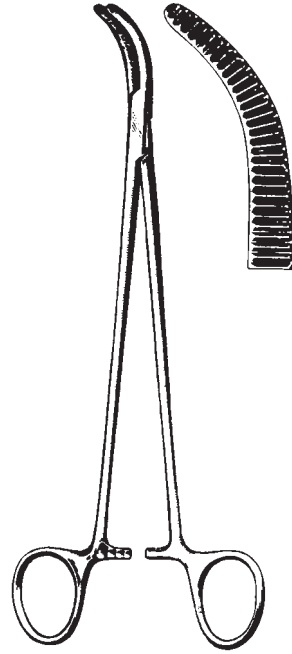

DESJARDINS  
13505-21 21 cm, 8 1/4"

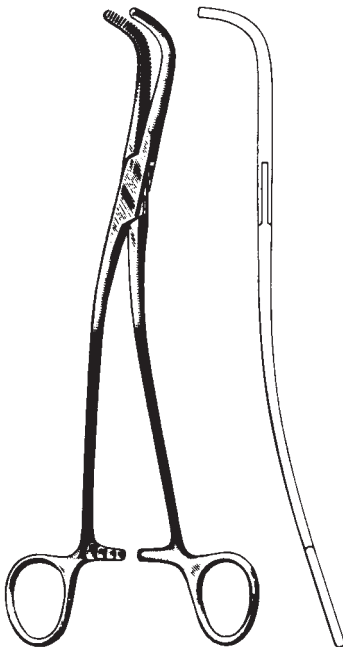

GRAY

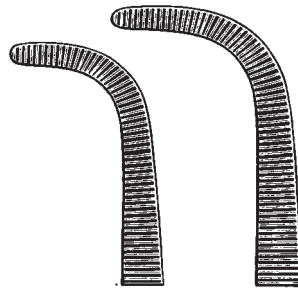

13507-22  
22 cm  
8 3/4"

13507-23  
23 cm  
9"

Arterienklemmen  
 Hemostatic Forceps  
 Pinzas hemostáticas  
 Pinze emostatiche

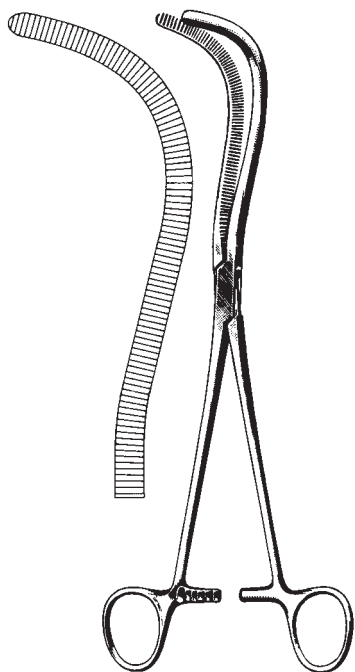

MAYO-GUYON  
 13513-23  
 23 cm, 9"

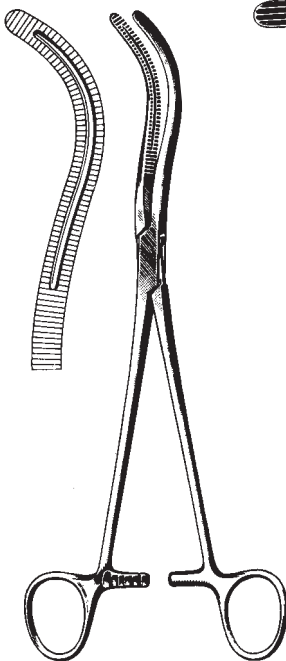

STILLE  
 13515-23  
 23 cm, 9"



GUYON  
 13517-23  
 23 cm, 9"

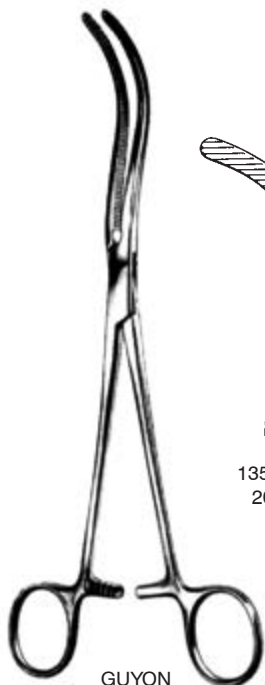

GUYON

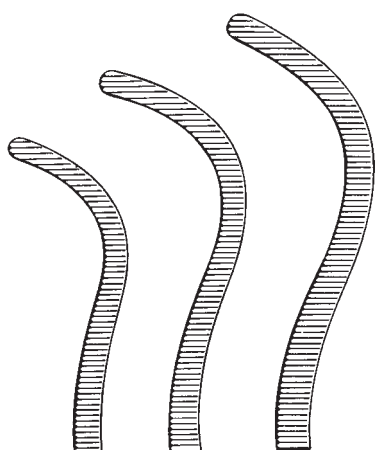

13519-20 20 cm 8"  
 13519-22 22 cm 8 3/4"  
 13519-24 24 cm 9 1/2"



GUYON



13520-23  
 23 cm  
 9"

ATRAUMA

13520-24  
 24 cm  
 9 1/2"



Hysterektomieklemmen  
 Hysterectomy Forceps  
 Pinzas para histerectomía  
 Pinze per isterectomia

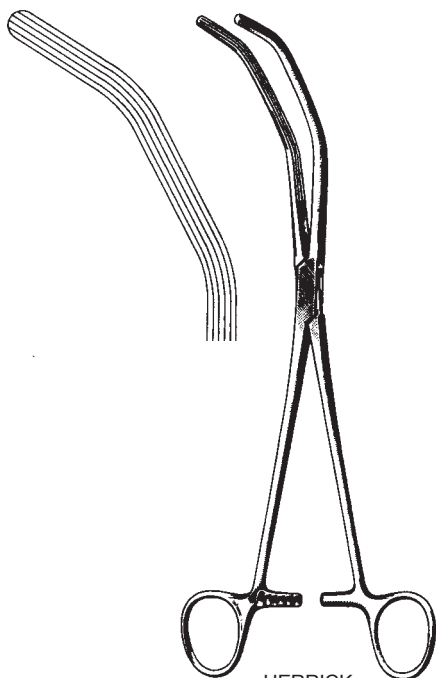

HERRICK  
 13523-23  
 23 cm, 9"

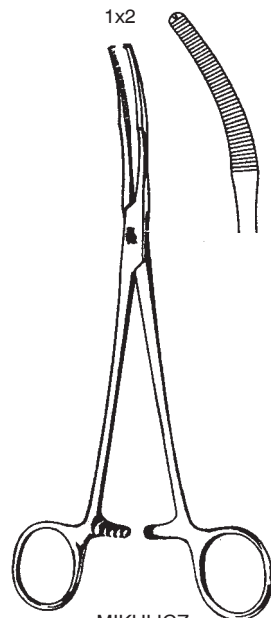

MIKULICZ  
 13551-14 14 cm, 5 1/4" BABY  
 13551-18 18 cm, 7"  
 13551-20 20 cm, 8"

Peritoneum-Klemme  
 Peritoneum Forceps  
 Pinzas para peritoneo  
 Pinze peritoneali

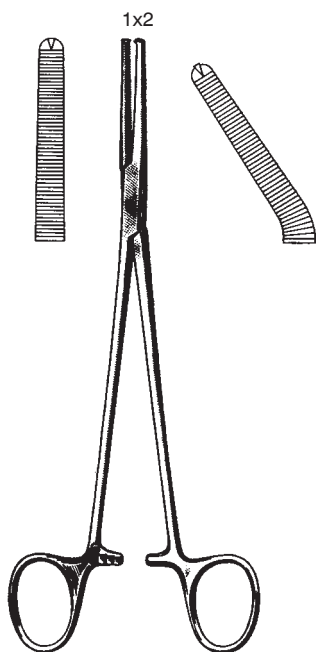

PHANEUF  
 13554-21 21 cm, 8 1/4" 13555-21



MIKULICZ  
 13556-24 24 cm, 9 1/2"

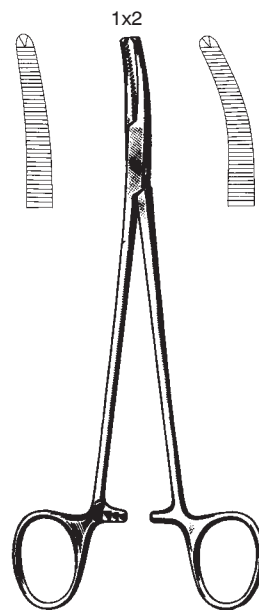

FAURE  
 13561-20 20 cm, 8" 13563-20

Hysterektomieklemmen  
Hysterectomy Forceps  
Pinzas para histerectomía  
Pinze per isterectomia



MAINGOT  
13564-20 20 cm, 8"

Hysterektomieklemmen  
Hysterectomy Forceps  
Pinzas para histerectomía  
Pinze per isterectomia



13565-20  
20,5 cm, 8"



13565-25  
25 cm, 10"

MAINGOT

Hysterektomieklemmen  
 Hysterectomy Forceps  
 Pinzas para histerectomía  
 Pinze per isterectomia



WERTHEIM  
 13570-23  
 23,5 cm, 9 1/4"

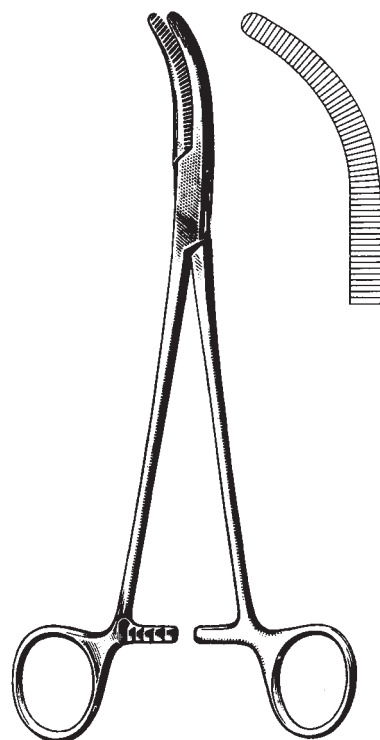

WERTHEIM  
 13571-25  
 25 cm, 10"

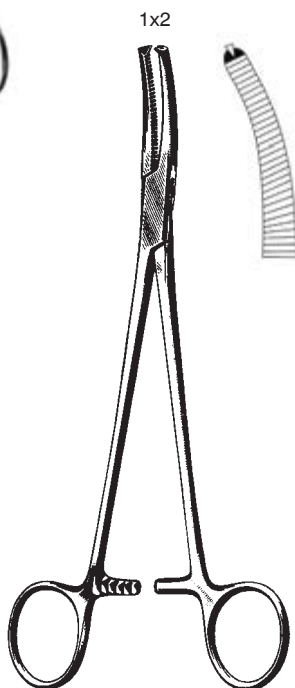

WERTHEIM  
 13573-22 22 cm, 8 3/4"

Hysterektomieklemmen  
Hysterectomy Forceps  
Pinzas para histerectomía  
Pinze per isterectomia



SEGOND-LANDAU  
13574-24  
24 cm, 9 1/2"



SEGOND  
13575-24  
24 cm, 9 1/2"



WERTHEIM-CULLEN  
13579-21 21,5 cm, 8 1/2"



Hysterektomieklemmen  
 Hysterectomy Forceps  
 Pinzas para histerectomía  
 Pinze per isterectomia



13580-80  
 80 mm, 3"  
 Maul/Morso/Boca



13580-60  
 60 mm, 2 1/4"  
 Maul/Morso/Boca



23 cm, 9"



13591-20  
 13591-23

13593-20  
 13593-23



HEANEY  
 20 cm, 8"

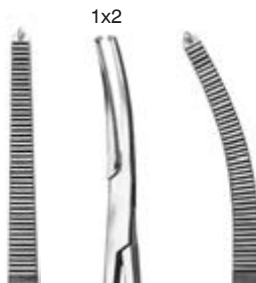

1x2



13598-24  
 HOLZBACH  
 24 cm, 9 1/2"  
 13599-24

Hysterektomieklemmen  
 Hysterectomy Forceps  
 Pinzas para histerectomía  
 Pinze per isterectomia



ATRAUMA

ROGERS  
 13595-10 - 13597-40



22 cm  
 8 3/4"  
 13595-10



21,5 cm  
 8 1/2"  
 13595-20



21 cm  
 8 1/4"  
 13595-30

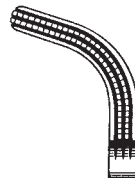

20,5 cm  
 8"  
 13595-40



25 cm  
 10"  
 13597-10



25 cm  
 10"  
 13597-20

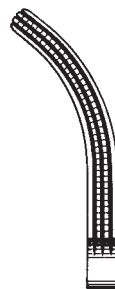

24,5 cm  
 9 3/4"  
 13597-30

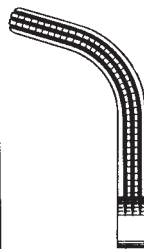

23 cm  
 9"  
 13597-40

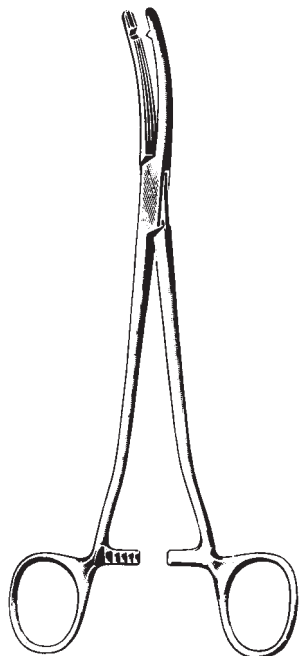

HEANY-BALLENTINE  
 13600-20 - 13601-20  
 20 cm, 8"



BALLENTINE  
 13600-20



HEANY-BALLENTINE  
 13601-20

Hysterektomieklemmen  
Hysterectomy Forceps  
Pinzas para histerectomía  
Pinze per isterectomia



WERTHEIM  
13605-26  
25,5 cm, 10"



Parametriumklemmen  
 Parametrium Clamps  
 Pinza para parametrio  
 Pinza per parametrio



REDA  
 21 cm 8 1/4"



13610-21



13611-21



13612-21



13613-21

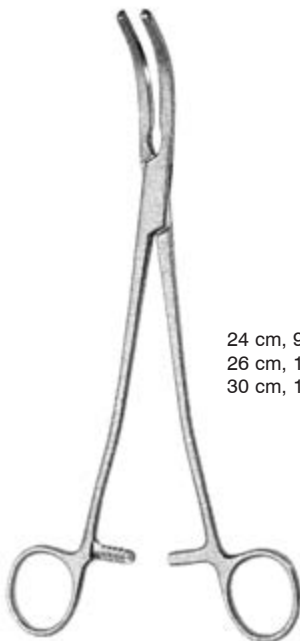

REDA



13620-24  
 13620-26  
 13620-30



13621-24  
 13621-26  
 13621-30



13622-24  
 13622-26  
 13622-30



13623-24  
 13623-26  
 13623-30

24 cm, 9 1/2"  
 26 cm, 10 1/4"  
 30 cm, 12"



Schlauchklemmen  
 Tubing Clamps  
 Pinzas cierra-tubos  
 Pinze serratubi

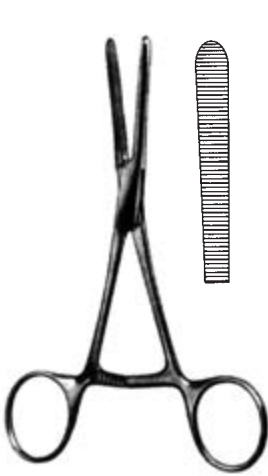

KLINIKUM BERLIN  
 13702-14  
 14,5 cm, 5 3/4"



13710-15  
 15 cm, 6"



13710-18  
 18 cm, 7"



13710-20  
 20 cm, 8"



PRESBYTERIAN  
 13704-16 16 cm, 6 1/4"  
 13704-18 18 cm, 7"

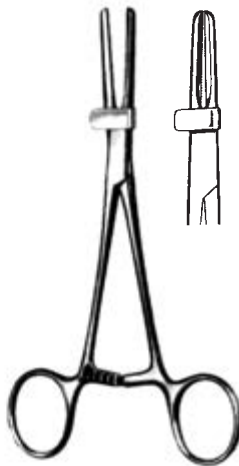

13712-15  
 15 cm, 6"



13712-18  
 18 cm, 7"



13712-20  
 20 cm, 8"



Rollenklemme  
Tube milking rollers  
Pinza de rodillos  
Pinze con rotelle



BÜLOW-GUNAR-HEY  
13720-18 18 cm, 7"

Rollenklemme  
Tube milking rollers  
Pinza de rodillos  
Pinze con rotelle



13730-16 16,5 cm, 6 1/2"

Tuchklemmen  
Towel Forceps  
Pinzas de campos  
Pinze fissateli



SCHAEDDEL  
15101-09  
9 cm, 3 1/2"



JONES  
15103-07  
7 cm, 2 3/4"



JONES-CLIP  
15105-09  
9 cm, 3 1/2"

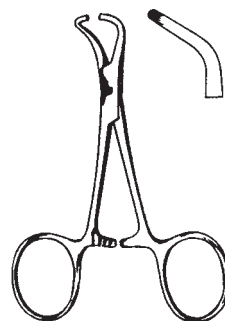

TOHUKU  
15107-10 10 cm, 4"  
15107-13 13 cm, 5 1/8"

15103-09  
9 cm, 3 1/2"



PEERS  
15108-14  
14,5 cm, 5 3/4"

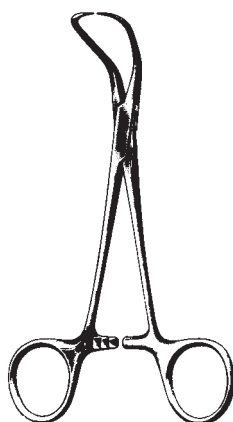

BACKHAUS  
15111-09 9 cm, 3 1/2"  
15111-11 11 cm, 4 3/8"  
15111-13 13 cm, 5 1/8"  
15111-15 15 cm, 6"



BACKHAUS-CLIP  
15115-11  
11 cm, 4 3/8"

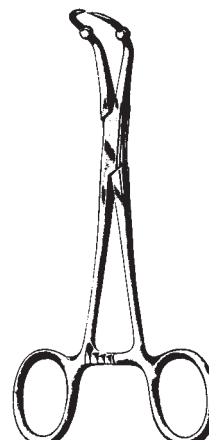

ROEDER  
15117-13  
13 cm, 5 1/8"

Tuchklemmen  
Towel Forceps  
Pinzas de campos  
Pinze fissateli



**LORNA**  
15121-11 11 cm, 4 <sup>3</sup>/<sub>8</sub>"  
15121-13 13 cm, 5 <sup>1</sup>/<sub>8</sub>"



**BALL AND SOCKET**  
15123-11 11 cm, 4 <sup>3</sup>/<sub>8</sub>"  
15123-13 13 cm, 5 <sup>1</sup>/<sub>8</sub>"



15125-14  
14,5 cm, 5 <sup>3</sup>/<sub>4</sub>"

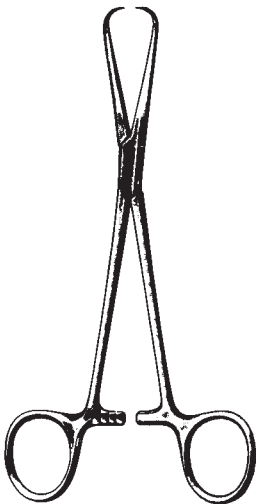

**BERNHARD**  
15140-16  
16,5 cm, 6 <sup>1</sup>/<sub>2</sub>"

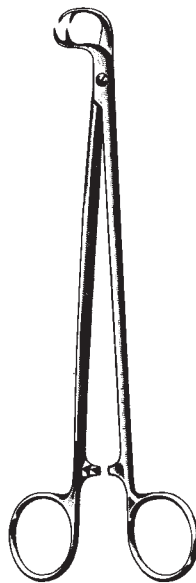

**MOYNIHAN**  
15150-19  
19 cm, 7 <sup>1</sup>/<sub>2</sub>"



**DOYEN**  
15161-18  
18 cm, 7"



**LANE**  
15164-15 15 cm, 6"  
15164-20 20 cm, 8"

Tupfer- und Kornzangen  
 Dressing Forceps  
 Pinzas para tampones y curaciones  
 Pinze per tamponi e per medicazione

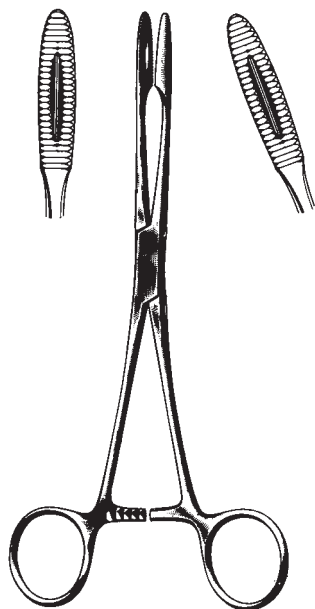

GROSS-MAIER

17110-20 20 cm, 8" 17111-20  
 17110-25 25 cm, 10" 17111-25

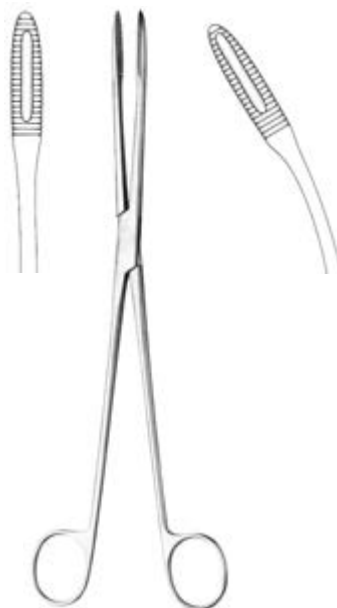

GROSS-MAIER

17112-20 20 cm, 8" 17113-20  
 17112-25 25 cm, 10" 17113-25



17120-28

17121-28



SIMS-MAIER  
 28 cm, 11"



DUPLAY

17131-21 21 cm, 8 1/4"



Tupfer- und Kornzangen  
Dressing Forceps  
Pinzas para tampones y curaciones  
Pinze per tamponi e per medicazione



17133-17 17 cm, 6 3/4"

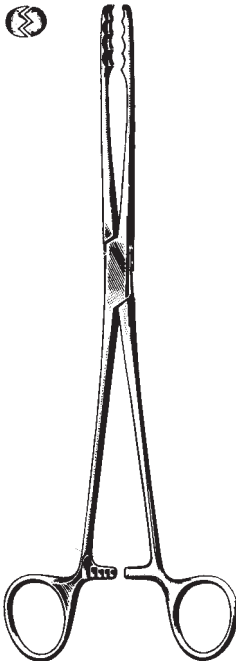

ULRICH  
17160-22 22 cm, 8 3/4"  
17160-25 25 cm, 10"

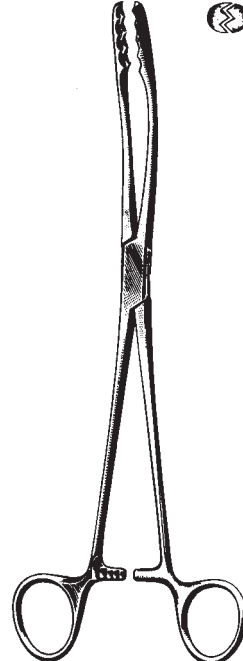

ULRICH  
17161-22 22 cm, 8 3/4"  
17161-25 25 cm, 10"

Schwammzange  
 Sponge Forceps  
 Pinzas porta-esponjas  
 Pinze per spugne

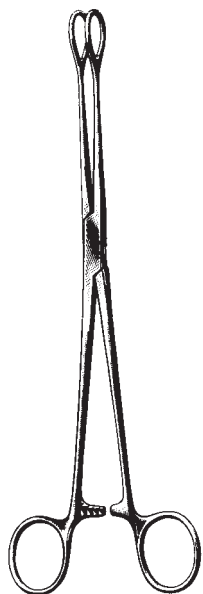

FOERSTER

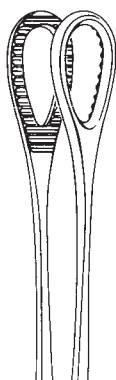

17170-18  
 17170-20  
 17170-25  
 17170-30

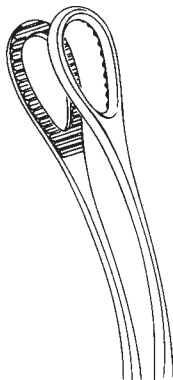

17171-18 18 cm, 7"  
 17171-20 20 cm, 8"  
 17171-25 25 cm, 10"

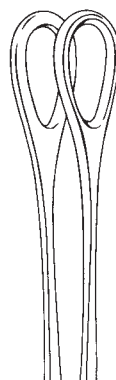

17172-18  
 17172-25

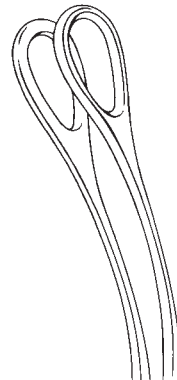

17173-18  
 17173-25



17174-25

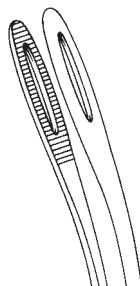

17175-25

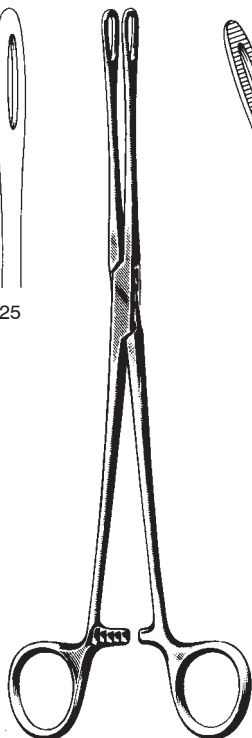

FOERSTER  
 25 cm, 10"



17180-18  
 18 cm, 7"



17180-25  
 25 cm, 10"

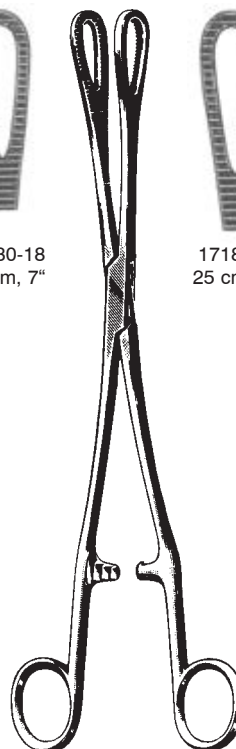

RAMPLEY

Kornzangen, Sinusklemmen  
 Dressing Forceps, Sinus Forceps  
 Pinzas para vendajes  
 Pinze per medicature, Pinze per seni



**BRYANT**  
 17207-13 13 cm, 5 1/8"



**LISTER (Sinus)**  
 17210-13 13 cm, 5 1/8"  
 17210-16 16 cm, 6 1/4"  
 17210-18 18 cm, 7"

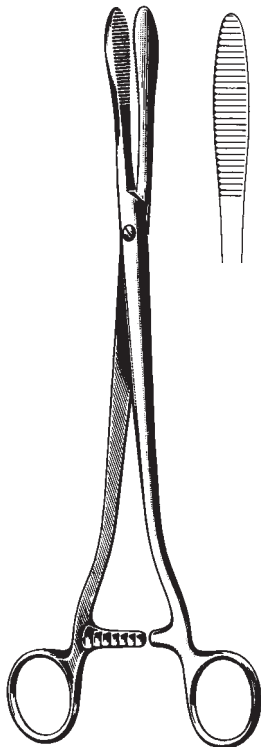

**COLLIN**  
 17220-25 25 cm, 10"

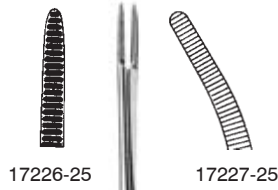

17226-25

17227-25



**PELKMANN**  
 25 cm, 10"



**CHERON**  
 17229-25 25 cm, 10"

Tamponzangen  
Dressing Forceps  
Pinzas para tapones  
Pinze per tamponi

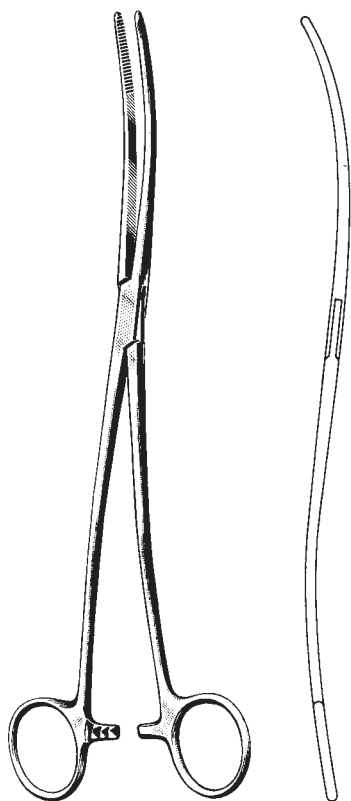

— BOZEMANN —  
17230-26 17231-26  
26 cm, 10 1/4"

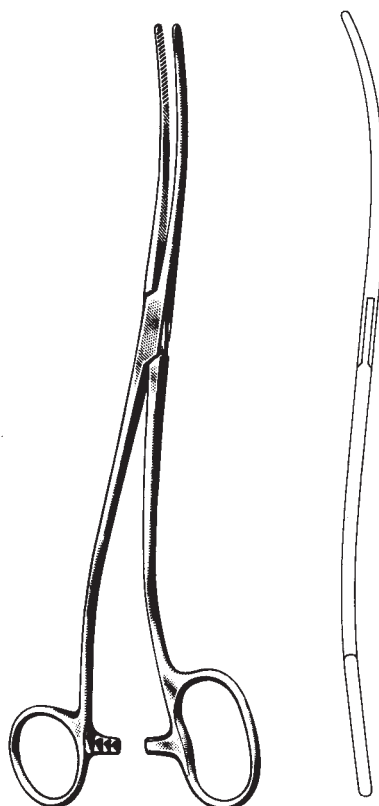

BOZEMANN-DOUGLAS  
17233-26  
26 cm, 10 1/4"

Wundhaken  
Retractors  
Separadores  
Divaricatori

Satz, set, juego, serie

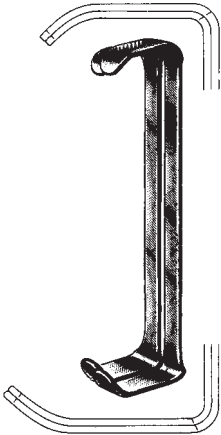

FARABEU  
19102-12  
12 cm, 4 3/4"

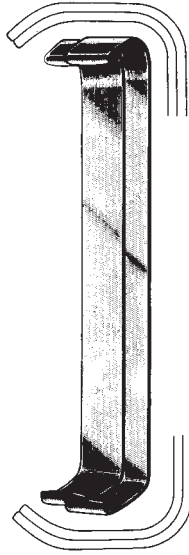

FARABEU  
19102-15  
15 cm, 6"



COLLIN  
19104-15  
15 cm, 6"

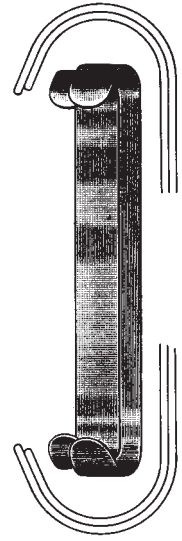

PARKER  
19110-13  
13,5 cm, 5 1/4"

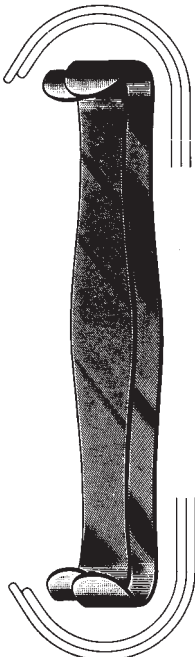

PARKER  
19110-18 18 cm, 7"

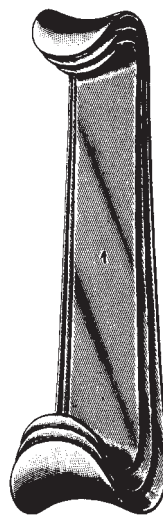

ROUX  
19120-00

Fig. 1 = 24x20 mm  
Fig. 2 = 29x26 mm  
Fig. 3 = 35x29 mm

Fig. 1 = 30x28 mm  
Fig. 2 = 36x36 mm  
Fig. 3 = 38x43 mm

19120-14 Fig. 1 14 cm, 5 1/2"  
19120-15 Fig. 2 15 cm, 6"  
19120-17 Fig. 3 17 cm, 6 3/4"

Wundhaken  
Retractors  
Separadores  
Divaricatori



ROUX BABY  
19122-13  
13 cm, 5 1/8"

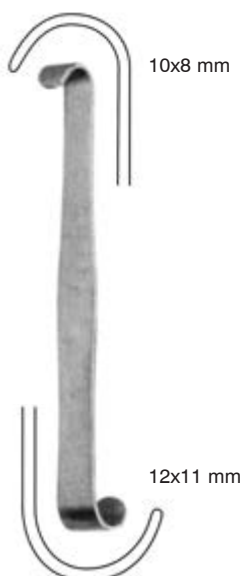

LUER  
19123-11  
11 cm, 4 3/8"



ROUX mini  
19124-15  
14 cm, 5 1/2"

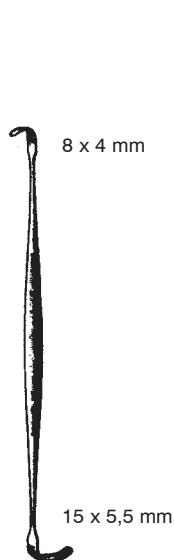

RAGNELL  
19125-14  
14 cm, 5 1/2"



ROSE  
19126-13  
13 cm, 5 1/8"

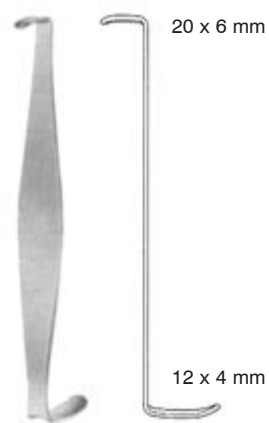

CRILE  
19127-11  
11,5 cm, 4 1/2"

Wundhaken  
Retractors  
Separadores  
Divaricatori

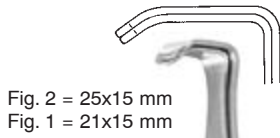

Fig. 2 = 25x15 mm  
Fig. 1 = 21x15 mm

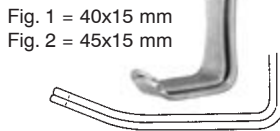
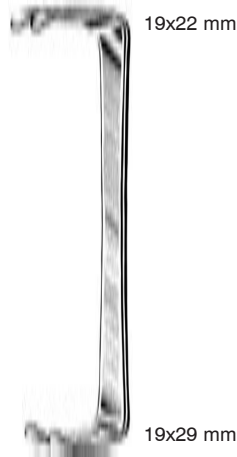

Fig. 1 = 40x15 mm  
Fig. 2 = 45x15 mm

US ARMY / Parker-Langenbeck  
19131-21 21 cm, 8 1/4"



MAYO-COLLINS  
19132-15 15 cm, 6"

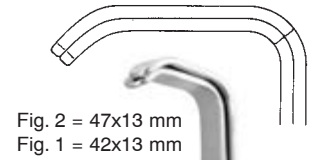

Fig. 2 = 47x13 mm  
Fig. 1 = 42x13 mm

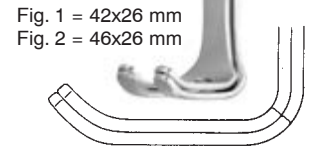
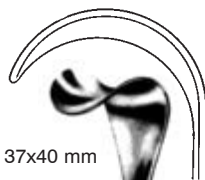
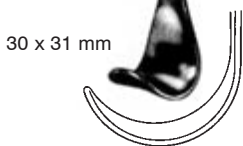

Fig. 1 = 42x26 mm  
Fig. 2 = 46x26 mm

MATHIEU  
19134-20 20 cm, 8"



37x40 mm



30 x 31 mm

GOELET  
19135-19 19 cm, 7 1/2"



38x22 mm

38x22 mm

CZERNY  
19136-20 17,5 cm, 6.9"

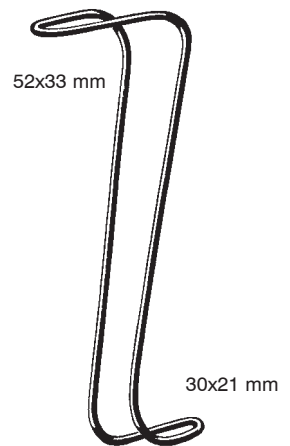

52x33 mm

30x21 mm

COLLIN-HARTMANN  
19137-16 16 cm, 6 1/4"

Wundhaken  
Retractors  
Separadores  
Divaricatori

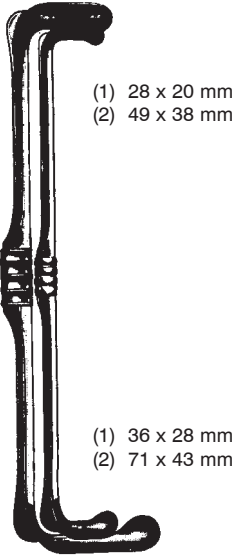

RICHARDSON-EASTMAN

- (Set) 19140-00  
(1) 19140-01 26 cm, 10 1/4"  
(2) 19140-02 28 cm, 11"

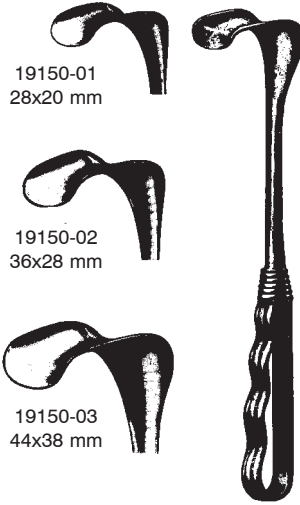

RICHARDSON

24 cm, 9 1/2"



RICHARDSON

19150-04  
24 cm, 9 1/2"

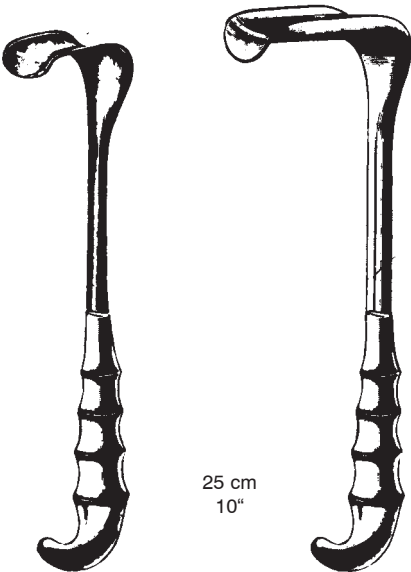

RICHARDSON GRIP

- 19152-25 20x25 mm  
19152-31 25x31 mm  
19152-38 38x38 mm  
19152-51 19x51 mm  
19152-64 41x64 mm

KELLY GRIP

- 19158-51 38x51 mm  
19158-64 51x64 mm  
19158-76 64x76 mm  
19158-82 70x82 mm



KELLY

26 cm, 10 1/4"



Wundhaken  
Retractors  
Separadores  
Divaricatori



19160-17



19161-17



SENN-MILLER  
17 cm, 6 <sup>3</sup>/<sub>4</sub>"



HASSON

**Satz, set, juego, serie**

19162-10 10 mm  
16 cm, 6 <sup>1</sup>/<sub>4</sub>"

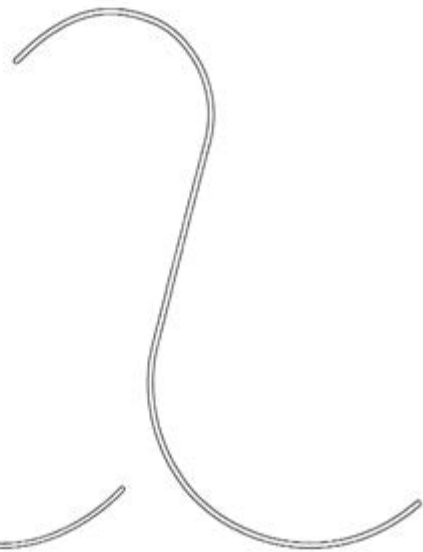

19162-13 13 mm  
18 cm, 7"

Bauch- und Darmspatel  
 Abdominal and intestinal spatulas  
 Separadores, espátula intestinal y abdominal  
 Divaricatori, spatole addominali e intestinali

biegsam, malleable, maleable, malleabili



RIBBON

19168-06	6x200 mm
19168-08	8x200 mm
19168-10	10x200 mm
19168-12	12x200 mm
19168-17	17x200 mm
19168-20	20x200 mm
19168-25	25x200 mm
19169-25	25x250 mm



RIBBON

19170-20	20x330 mm
19170-25	25x330 mm
19170-32	32x330 mm
19170-40	40x330 mm
19170-45	45x330 mm
19170-50	50x330 mm
19170-65	65x330 mm
19170-76	76x330 mm

Bauch- und Darmspatel  
Abdominal and intestinal spatulas  
Separadores, espátula intestinal y abdominal  
Divaricatori, spatole addominali e intestinali

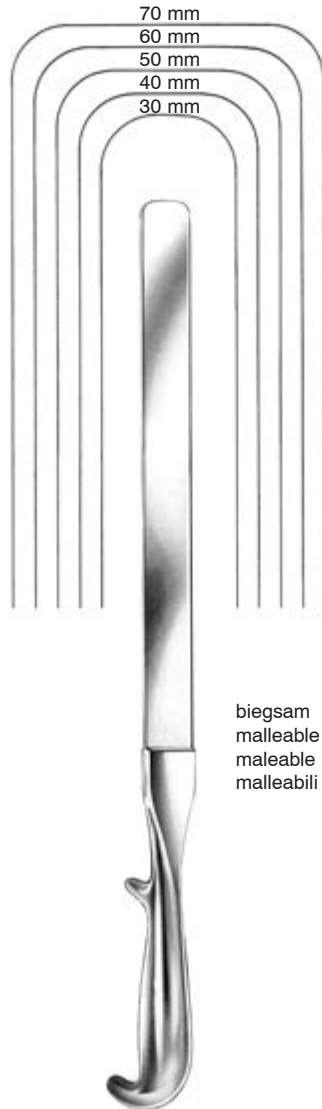

41 cm, 16"  
19171-30 30 mm  
19171-40 40 mm  
19171-50 50 mm  
19171-60 60 mm  
19171-70 70 mm

Bauch- und Darmspatel  
 Abdominal and intestinal spatulas  
 Separadores, espátula intestinal y abdominal  
 Divaricatori, spatole addominali e intestinali

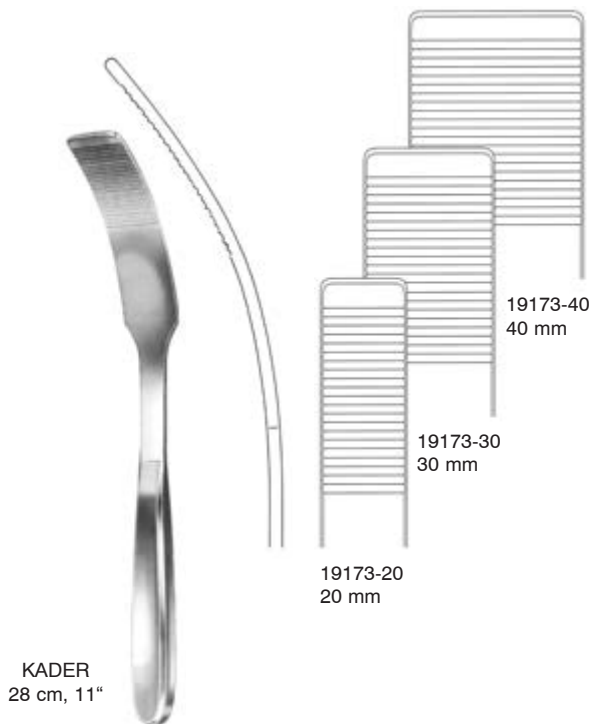

HABERER  
 19174-17 17/25x200 mm  
 19174-25 25/30x280 mm  
 19174-37 37/45x300 mm  
 19174-40 40/50x300 mm



REVERDIN  
 19175-28  
 28 cm, 11"

Bauch- und Darmspatel  
Abdominal and intestinal spatula  
Separadores, espátula intestinal y abdominal  
Divaricatori, spatole addominali e intestinali

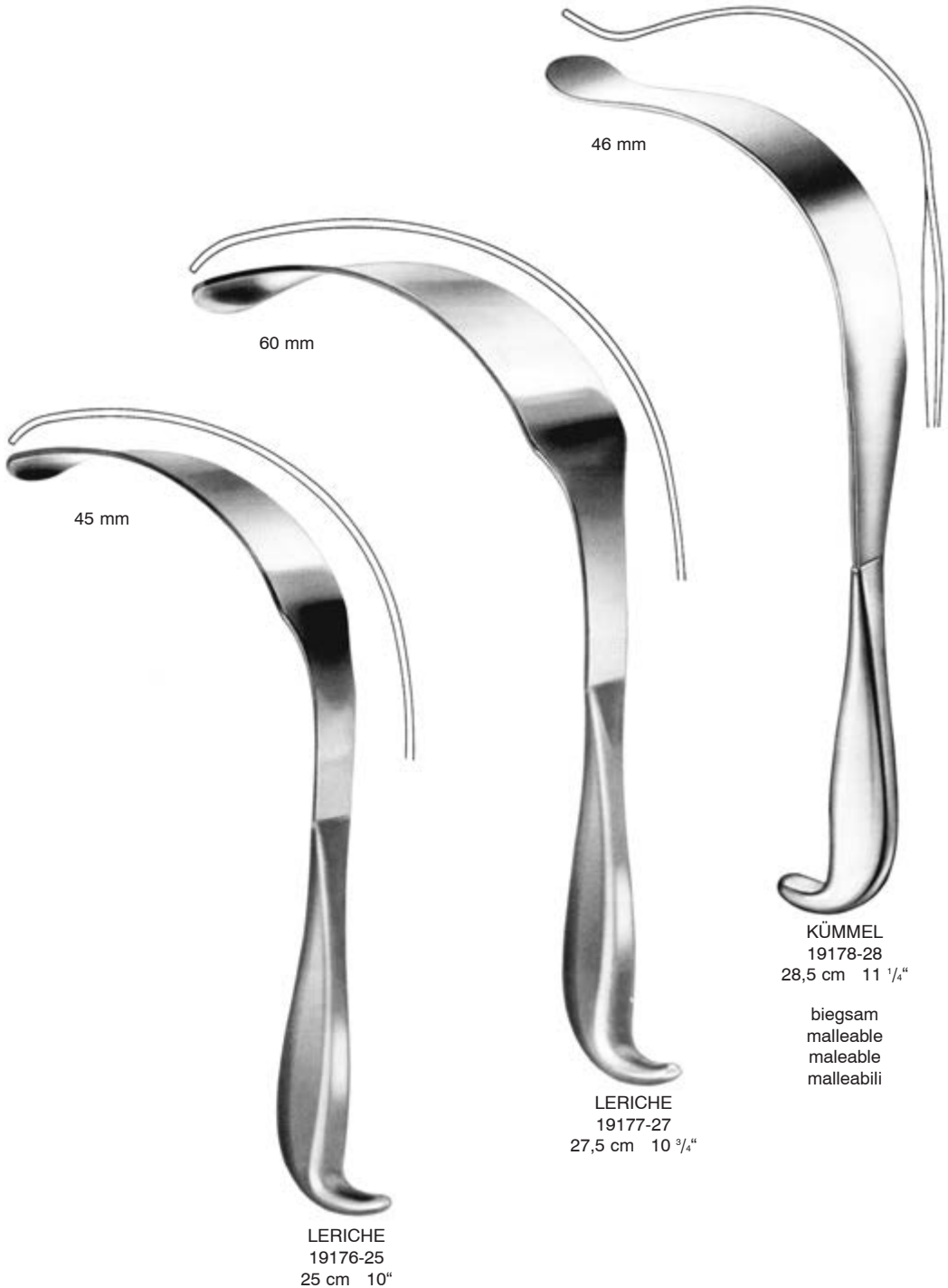

Bauchspatel  
Abdominal Spatulas  
Espátula abdominal  
Spatola addominale



KÜMMEL  
19179-28  
31 cm 12 1/4"

Wundhaken  
Retractors  
Separadores  
Divaricatori



DEAVER  
19180-19  
19 cm, 7 1/2"



DEAVER  
19181-22  
21,5 cm, 8 1/2"



DEAVER  
19181-25  
23 cm, 9"



DEAVER  
19183-25  
30 cm, 11 3/4"



DEAVER  
19185-25  
33 cm, 13"



DEAVER  
19187-25  
36 cm, 14"

Wundhaken  
Retractors  
Separadores  
Divaricatori



38 mm

DEAVER  
19187-38  
30 cm, 11 <sup>3</sup>/<sub>4</sub>"



50 mm

DEAVER  
19187-50  
31 cm 12 <sup>1</sup>/<sub>4</sub>"



75 mm

DEAVER  
19187-75  
32 cm, 12 <sup>3</sup>/<sub>4</sub>"



DEAVER GRIP  
19189-25 25x310 mm  
19189-38 38x310 mm  
19189-50 50x310 mm  
19189-75 75x310 mm  
31 cm 12 <sup>1</sup>/<sub>4</sub>"



Wundhaken  
Retractors  
Separadores  
Divaricatori

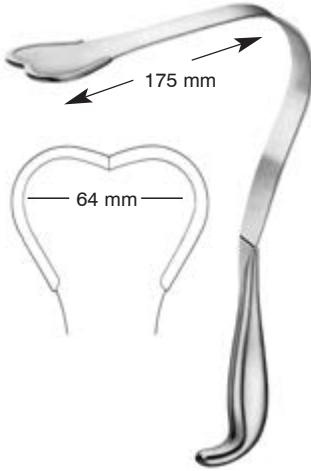

HARRINGTON-PEMBERTON  
19190-64  
29,5 cm 11 <sup>3</sup>/<sub>4</sub>"



HARRINGTON  
19191-25 25x230 mm  
19191-40 40x320 mm  
19191-62 62x320 mm



TUFFIER  
19192-23  
23 cm, 9"

Wundhaken  
Retractors  
Separadores  
Divaricatori

30°  
rechts  
right  
a la derecha  
a destra



45x48 mm

COOLEY  
19195-01  
24,5 cm, 9 3/4"

30°  
rechts, gerieft  
right serrated  
a la derecha, estriado  
a destra, zigrinato



45x48 mm

COOLEY  
19195-02  
24,5 cm, 9 3/4"

30°  
links  
left  
a la izquierda  
a sinistra



24x48 mm

COOLEY  
19195-03  
25,5 cm, 10"

Aortahaken  
Aorta Retractors  
Separadores para aorta  
Divaricatori per aorta



ROSS

flexibler Schaft  
flexible shaft  
vástago flexible  
asta flessibile



19196-01  
24 cm, 9 1/2"



19196-02  
24,5 cm, 9 3/4"



19196-03  
25 cm, 10"



19196-04  
25,5 cm, 10"



19196-05  
27 cm, 10 1/2"



19196-06  
25,5 cm, 10"

## Hauthäkchen

Nerve and wound hooks

Ganchos y ganchitos para nervios

Uncini per nervi e divaricatori fini



GRAEFE  
19210-12  
scharf  
sharp  
agudo  
acuto



GRAEFE  
19211-12  
stumpf  
blunt  
romo  
smusso



12 cm, 4 3/4"



GUTHRIE  
19212-01



GUTHRIE  
19212-02



## FRAZIER

- |   |          |           |
|---|----------|-----------|
| A | 19214-13 | 13 cm, 5" |
| A | 19214-18 | 18 cm, 7" |
| B | 19215-13 | 13 cm, 5" |
| B | 19215-18 | 18 cm, 7" |



scharf  
sharp  
agudo  
acuto  
A

stumpf  
blunt  
romo  
smusso  
B

B



stumpf  
blunt  
romo  
smusso  
B

B

Hauthäkchen  
 Nerve and wound hooks  
 Ganchos y ganchitos para nervios  
 Uncini per nervi e divaricatori fini

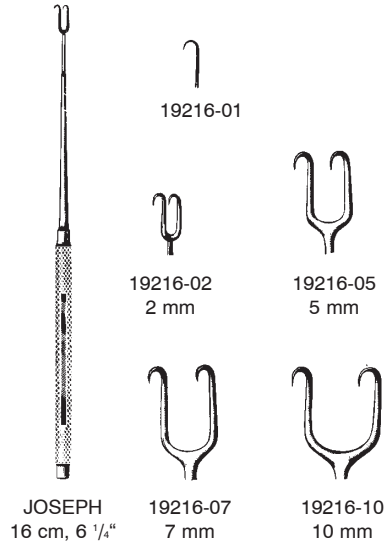

Hauthäkchen  
 Nerve and wound hooks  
 Ganchos y ganchitos para nervios  
 Uncini per nervi e divaricatori fini

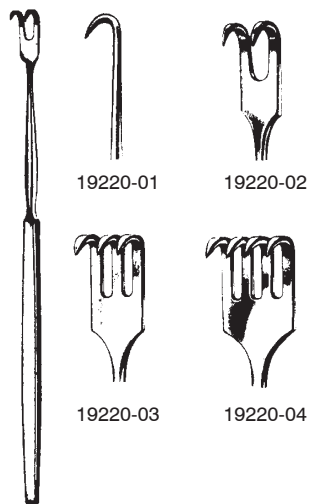

19220-01

19220-02

19220-03

19220-04

REDA  
 16 cm, 6 1/4"

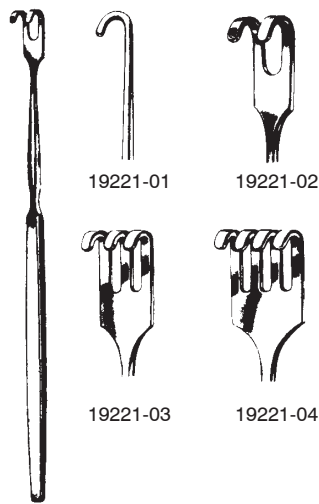

19221-01

19221-02

19221-03

19221-04

REDA  
 16 cm, 6 1/4"

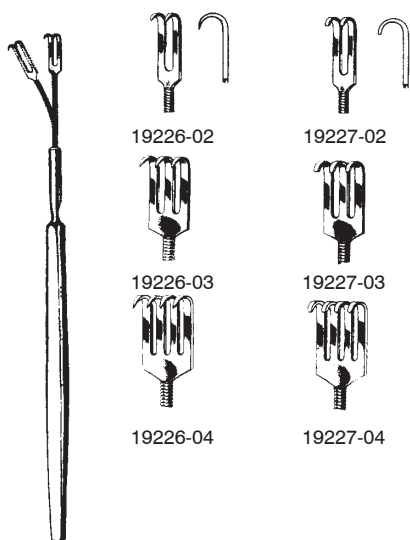

19226-02

19227-02

19226-03

19227-03

19226-04

19227-04

REDA, flexibel  
 16 cm, 6 1/4"



19229-02

19229-03

KLAPP  
 17,5 cm, 6.9"

Sattelhäkchen  
Saddle Hooks  
Ganchos en forma de silla  
Divaricatori a forma di sella



DESMARRES  
16 cm, 6 1/4"



19230-12 12 mm



19230-10 10 mm



19230-14 14 mm



19230-16 16 mm



19230-18 18 mm



19231-11  
11x14 mm



19231-13  
13x18 mm



19231-15  
15x22 mm

CUSHING  
25 cm, 10"



CUSHING  
20 cm, 8"



19232-08 8 mm



19232-10 10 mm



19232-12 12 mm



19232-14 14 mm



19232-16 16 mm



19232-18 18 mm

Sattelhäkchen  
 Saddle Hooks  
 Ganchos en forma de silla  
 Divaricatori a forma di sella



CUSHING  
 24 cm, 9 1/2"

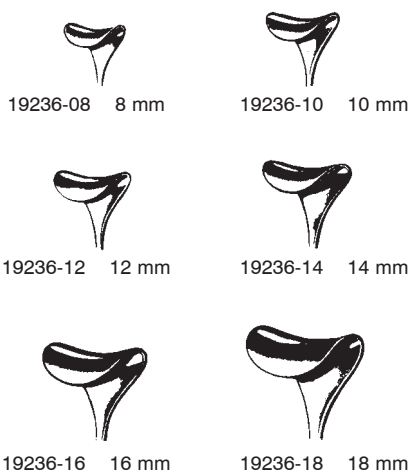

19236-08 8 mm

19236-10 10 mm

19236-12 12 mm

19236-14 14 mm

19236-16 16 mm

19236-18 18 mm



GIL-VERNET  
 24 cm, 9 1/2"

biegsam  
 malleable  
 maleable  
 malleabile



19233-08  
 8 mm

19233-11  
 11 mm

19233-15  
 15 mm



19233-17  
 17 mm

19233-20  
 20 mm

19233-23  
 23 mm



Wundhaken  
Retractors  
Separadores  
Divaricatori



CUSHING  
19234-20  
20 cm, 8"



CUSHING  
19235-21  
21,5 cm, 8 1/2"



KÖNIG  
18 cm, 7"



19236-01  
13x13 mm



19236-02  
12x16 mm



SENN-GREEN  
15 cm, 6"



19240-10 10x6 mm



19240-20 20x6 mm



LANGENBECK-GREEN  
16 cm, 6 1/4"



19250-16  
16x6 mm



19250-24  
24x6 mm



VOLKMANN  
11,5 cm, 4 1/2"



19270-02



19271-02



19270-03



19271-03



19270-04



19271-04



19270-06



19271-06

Wundhaken  
 Retractors  
 Separadores  
 Divaricatori



19280-01



19280-02



19280-03



19280-04



19280-06



scharf  
 sharp  
 agudo  
 acuto



19281-01



19281-02



19281-03



19281-04



19281-06



stumpf  
 blunt  
 romo  
 smusso



19282-02



19282-03



19282-04



19282-06



halbscharf  
 semi-sharp  
 medio romo  
 mezzo smusso



VOLKMANN  
 21,5 cm, 8 1/2"

Wundhaken  
Retractors  
Separadores  
Divaricatori



19296-01



19296-02



19296-03



19296-04



19296-06

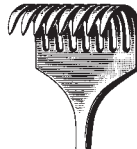

19296-08



scharf  
sharp  
agudo  
acuto



19297-01



19297-02



19297-03



19297-04



19297-06

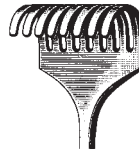

19297-08



stumpf  
blunt  
romo  
smusso



KOCHER  
22 cm, 8 <sup>3</sup>/<sub>4</sub>"

Wundhaken, Knochenhaken  
 Retractors, Bone Retractors  
 Separadores, Separadores oseos  
 Divaricatori, Divaricatori per ossa

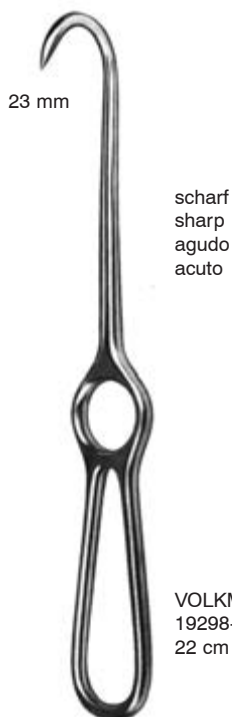

VOLKMANN  
 19298-01  
 22 cm 8 3/4"



VOLKMANN  
 19299-01  
 22 cm 8 3/4"

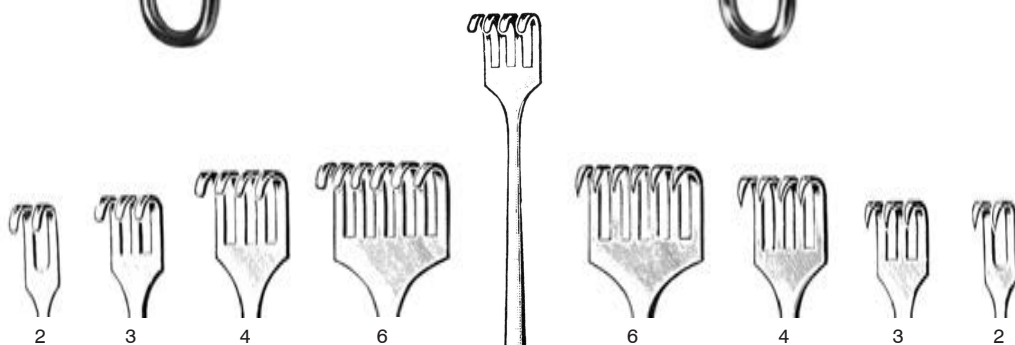

stumpf  
blunt  
romo  
smusso

- 19301-02 8x 8 mm
- 19301-03 8x13 mm
- 19301-04 8x18 mm
- 19301-06 8x28 mm

scharf  
sharp  
agudo  
acuto

- 19300-02 8x 8 mm
- 19300-03 8x13 mm
- 19300-04 8x18 mm
- 19300-06 8x28 mm

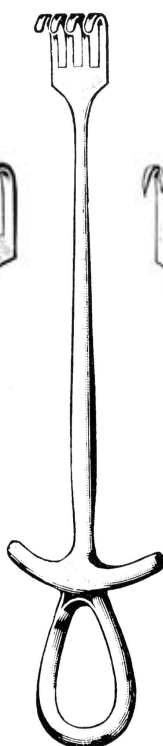

MURPHY  
 19,4 cm 7 5/8"

Wundhaken  
Retractors  
Separadores  
Divaricatori



MEYERDING  
18 cm, 7"



19302-01 18x7 mm



19302-04 7x4 mm



19302-02 16x5 mm



19302-05 10x3 mm



19302-03 7x4 mm



19302-06 10x4 mm



28x6 mm



LAHEY  
19304-19  
19 cm, 7 1/2"



12x14 mm

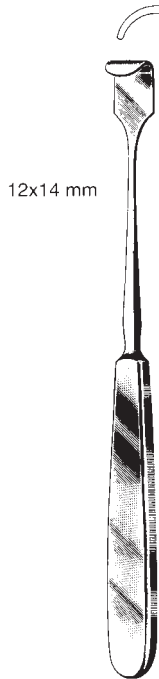

LITTLE  
19306-20  
20 cm, 8"



STRANDELL-STILLE  
17 cm 6 3/4"



19307-01



19307-02

Wundhaken  
 Retractors  
 Separadores  
 Divaricatori

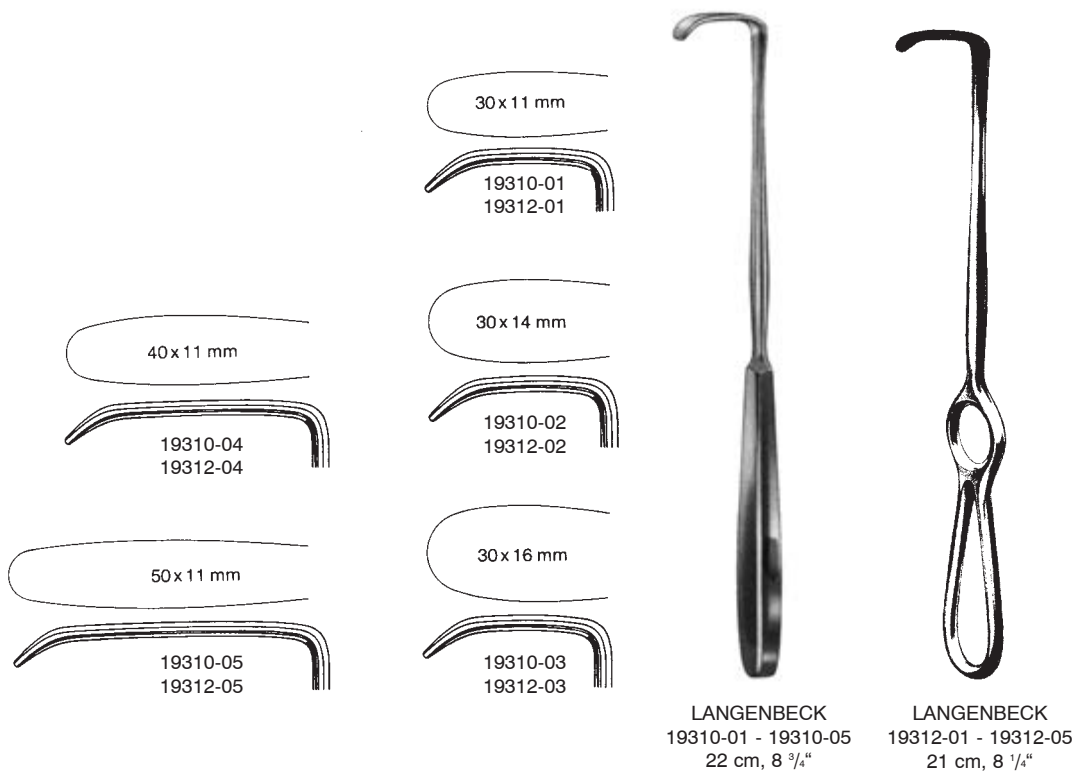

Wundhaken  
Retractors  
Separadores  
Divaricatori

- 19315-06 25x 6 mm
- 19314-07 35x 7 mm
- 19314-10 35x10 mm
- 19314-12 80x12 mm
- 19314-14 70x14 mm
- 19314-15 35x15 mm
- 19314-16 80x16 mm
- 19314-20 60x20 mm
- 19330-40 40x12 mm
- 19330-55 55x11 mm

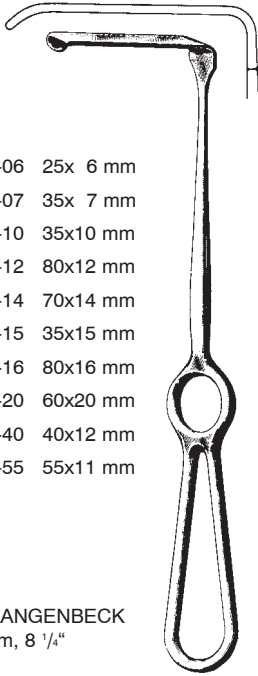

KOCHER-LANGENBECK  
21 cm, 8 1/4"

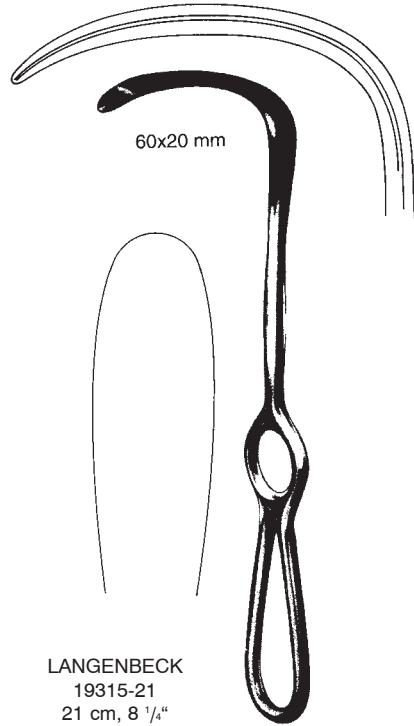

LANGENBECK  
19315-21  
21 cm, 8 1/4"



LANGENBECK  
19317-21  
21 cm, 8 1/4"

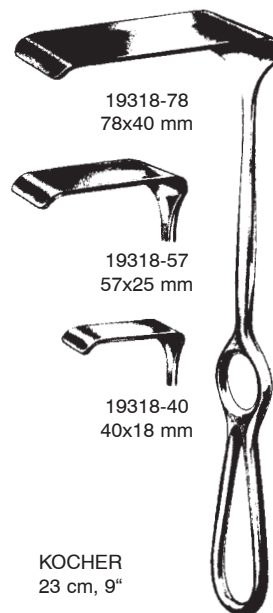

KOCHER  
23 cm, 9"

Wundhaken  
Retractors  
Separadores  
Divaricatori



19344-14  
14x17 mm  
21,5 cm, 8 1/2"



19344-20  
20x22 mm  
22 cm, 8 3/4"



19344-26  
26x30 mm  
23,5 cm, 9 1/4"



MIDDELDORPF  
19344-14 - 19344-26



KOCHER  
19340-10 40x10 mm  
19340-15 40x15 mm  
19340-20 40x20 mm  
22 cm, 8 3/4"

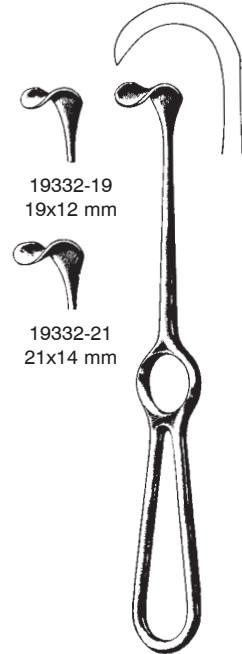

19332-19  
19x12 mm



19332-21  
21x14 mm

KOCHER  
19332-19 - 19332-21  
19 cm, 7 1/2"



MIDDELDORPF  
19345-01 45x45 mm  
25,5 cm, 10"



19345-02  
45x50 mm



19345-03  
55x70 mm



GREEN  
19348-22  
22 cm, 8 3/4"



Wundhaken  
Retractors  
Separadores  
Divaricatori

35 x 8 mm



ZENKER  
19350-35  
25 cm, 10"

60 x 12 mm



ZENKER  
19350-60  
26 cm, 10 1/4"

75 x 12 mm



ZENKER  
19350-70  
27,5 cm, 10.8"

Wundhaken  
 Retractors  
 Separadores  
 Divaricatori

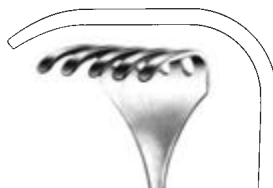

19364-50 45x50 mm



19364-60 50x60 mm

ISRAEL

19364-40 40X40 mm  
 25 cm, 10"

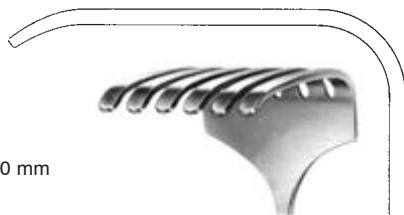

19364-70 70x70 mm

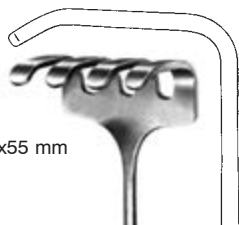

35x55 mm

OLLIER

19360-04 22,5 cm, 8.9"

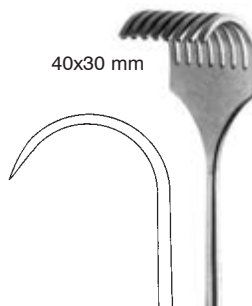

40x30 mm

spitz  
 sharp  
 agudo  
 acuto

stumpf  
 blunt  
 romo  
 smusso

KOERTE

19366-08 23,5 cm, 9 1/4" 19367-08

Wundhaken  
Retractors  
Separadores  
Divaricatori

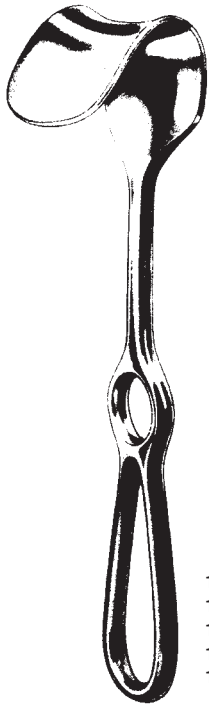

**FRITSCH**  
19370-40 45x40 mm  
19370-50 45x50 mm  
19370-60 45x60 mm  
19370-75 45x75 mm  
19370-85 65x85 mm  
24 cm, 9 1/2"



**KOCHER**  
19372-22  
70x25 mm  
22,5 cm, 8.9"

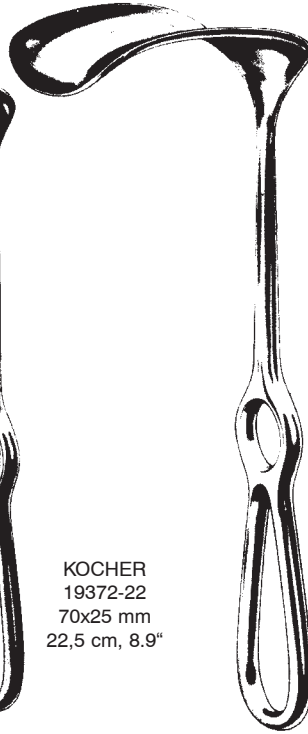

**KOCHER**  
19374-45 80x45 mm  
19374-55 80x55 mm  
19374-65 80x65 mm  
25 cm, 10"

50x85 mm



**DOYEN**  
19378-25  
25 cm, 10"

19382-50 90x50 mm

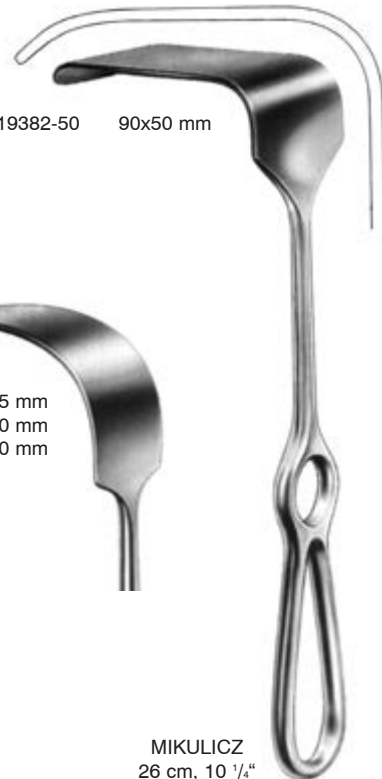

**MIKULICZ**  
26 cm, 10 1/4"

19380-35 95x35 mm  
19380-50 120x50 mm  
19381-50 150x50 mm

Wundhaken  
Retractors  
Separadores  
Divaricatori



19388-40 70x40 mm  
19388-50 70x50 mm  
19388-65 70x65 mm

MORRIS  
24,5 cm  
9 3/4"

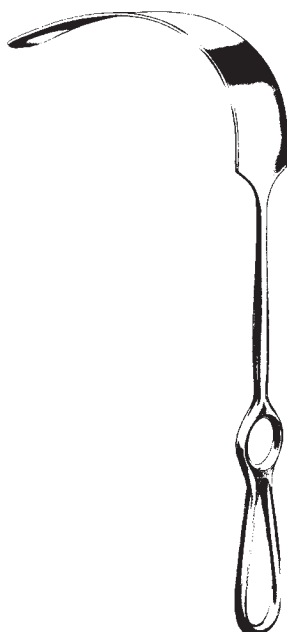

KELLY  
19385-38 160x38 mm  
19385-57 160x57 mm  
27 cm, 10 1/2"



SIMON  
19480-22 115x22 mm  
19480-27 115x27 mm  
28 cm, 11"

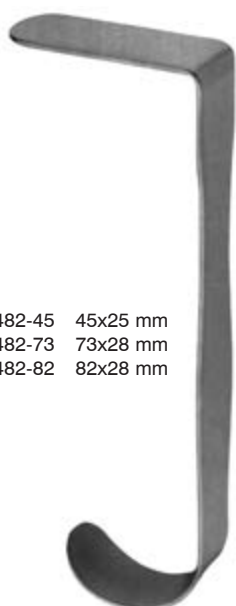

19482-45 45x25 mm  
19482-73 73x28 mm  
19482-82 82x28 mm

HEANEY  
27 cm, 10 1/2"

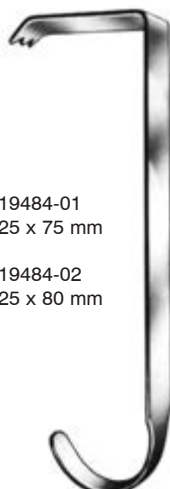

19484-01  
25 x 75 mm

19484-02  
25 x 80 mm

HIBBS  
24 cm, 9 1/2"

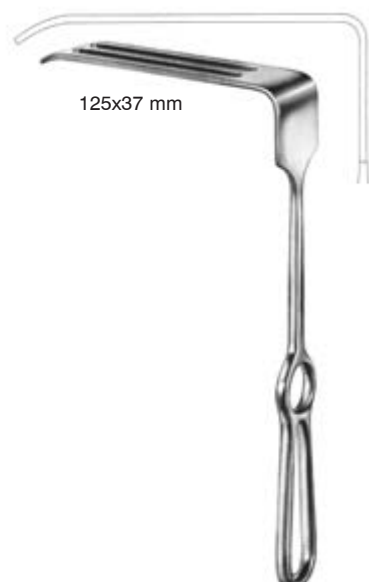

125x37 mm

SAUERBRUCH  
19492-25  
25 cm, 10"

Pelvis-Haken  
Pelvis retractor  
Retractor de pelvis  
Divaricatori pelvici

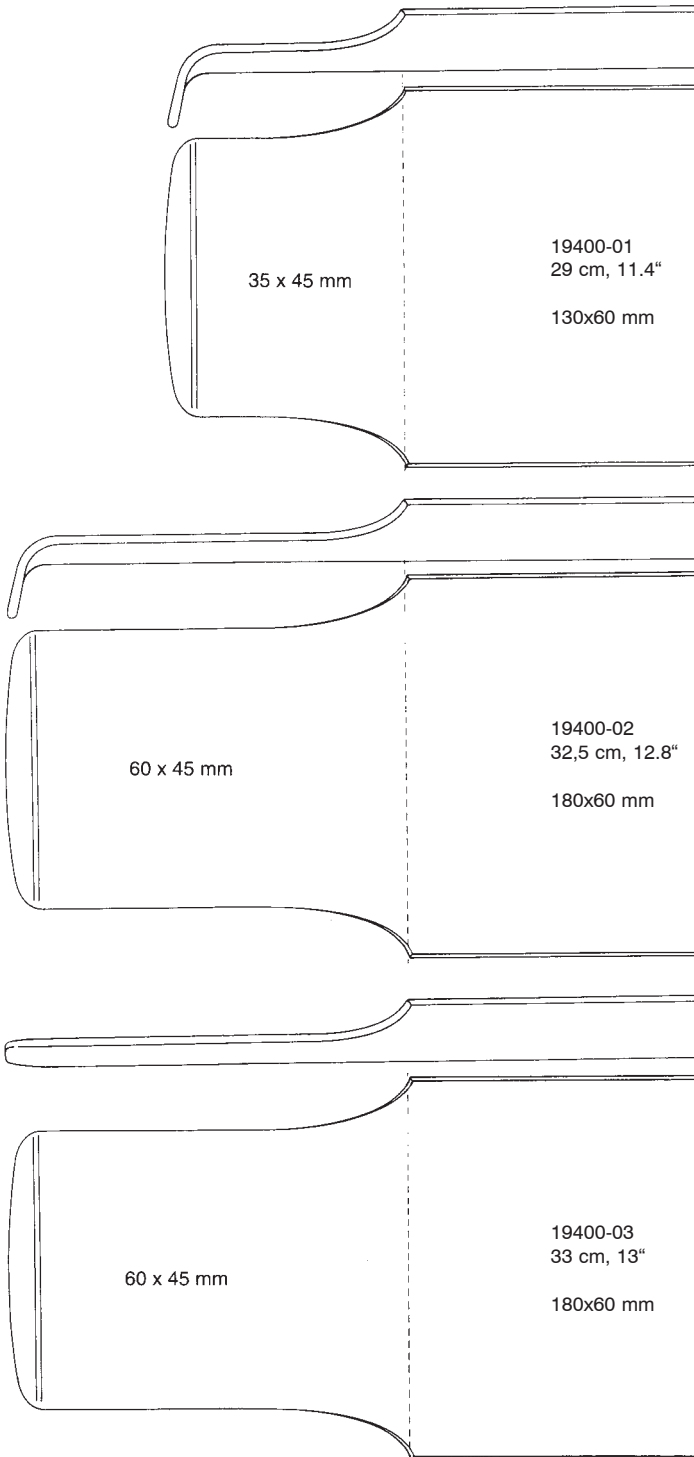

ST. MARKS  
19400-01 19400-03

Wundhaken, Scapulahaken  
 Retractors, Scapula Retractors  
 Separadores, Separadores para escápula  
 Divaricatori, Divaricatori per scapola



19490-65 115x65 mm  
 19490-43 108x43 mm  
 19490-22 82x22 mm

CORYLLOS (Thorax)  
 24 cm, 9 1/2"



19494-45 45x15 mm  
 19494-60 60x23 mm  
 19494-75 75x20 mm

SAUERBRUCH  
 22,5 cm, 8.9"



DAVIDSON  
 19496-50 75x50 mm



DAVIDSON  
 19496-90 75x90 mm

Wundhaken  
Retractors  
Separadores  
Divaricatori

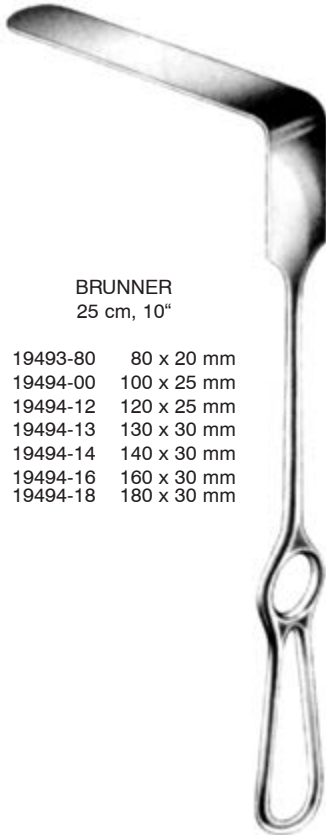

BRUNNER  
25 cm, 10"

19493-80	80 x 20 mm
19494-00	100 x 25 mm
19494-12	120 x 25 mm
19494-13	130 x 30 mm
19494-14	140 x 30 mm
19494-16	160 x 30 mm
19494-18	180 x 30 mm

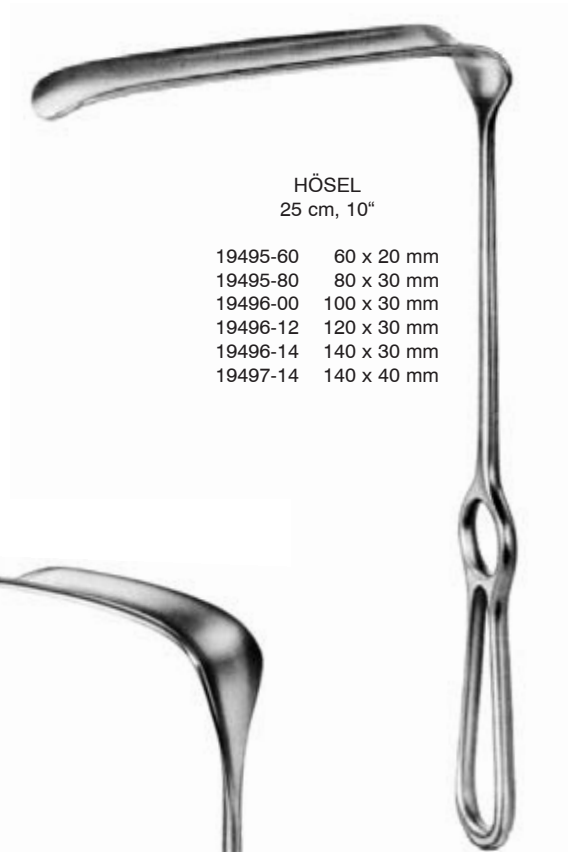

HÖSEL  
25 cm, 10"

19495-60	60 x 20 mm
19495-80	80 x 30 mm
19496-00	100 x 30 mm
19496-12	120 x 30 mm
19496-14	140 x 30 mm
19497-14	140 x 40 mm



DOYEN-STILLE  
25 cm, 10"

19498-01	97 x 29 mm
19498-02	101 x 31 mm
19498-03	127 x 52 mm

Wundsperrer, Kieferhöhlensperrer  
 Retractors, Antrum Retractor  
 Separadores, Separadores para seno maxilar  
 Divaricatori, Divaricatori per seno mascellare

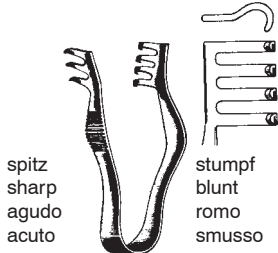

spitz  
sharp  
agudo  
acuto

stumpf  
blunt  
romo  
smusso

FINSEN  
 19610-07 7 cm, 2 3/4" 19611-07

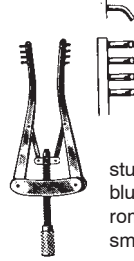

spitz  
sharp  
agudo  
acuto

stumpf  
blunt  
romo  
smusso

ALM  
 19620-07 7 cm, 2 3/4" 19621-07  
 19620-10 10 cm, 4" 19621-10



spitz  
sharp  
agudo  
acuto

JANSSEN  
 19630-10  
 10 cm, 4"



stumpf  
blunt  
romo  
smusso

JANSSEN  
 19631-10  
 10 cm, 4"



spitz  
sharp  
agudo  
acuto

stumpf  
blunt  
romo  
smusso

HOLZHEIMER  
 19634-10 19635-10  
 10 cm, 4"



PERKINS  
 19636-14  
 13 cm, 5 1/8"



PERKINS  
 19637-14  
 13 cm, 5 1/8"



Wundsperrer  
Retractors  
Separadores  
Divaricatori

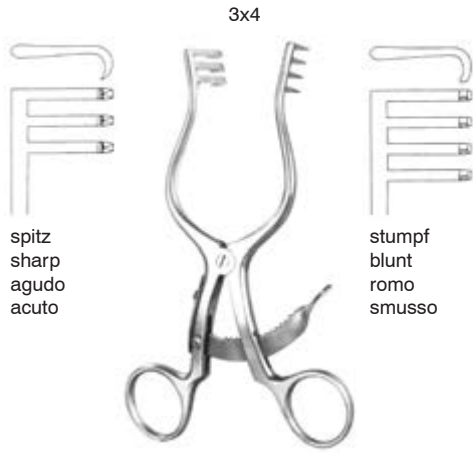

spitz  
sharp  
agudo  
acuto

stumpf  
blunt  
romo  
smusso

SCALP-CONTOUR  
19640-14 - 19641-14  
13,5 cm, 5 1/4"

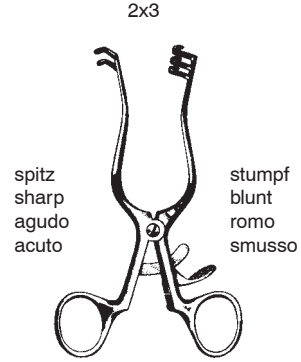

spitz  
sharp  
agudo  
acuto

stumpf  
blunt  
romo  
smusso

WEITLANER  
19650-10 19651-10  
11,5 cm, 4 1/2"

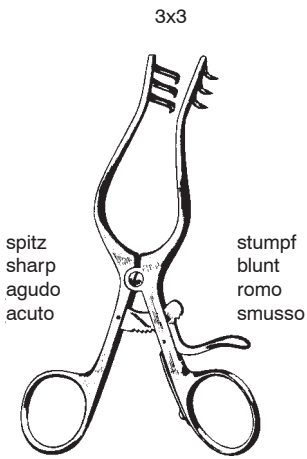

spitz  
sharp  
agudo  
acuto

stumpf  
blunt  
romo  
smusso

WEITLANER-WULLSTEIN  
19654-13 19655-13  
13 cm, 5 1/8"

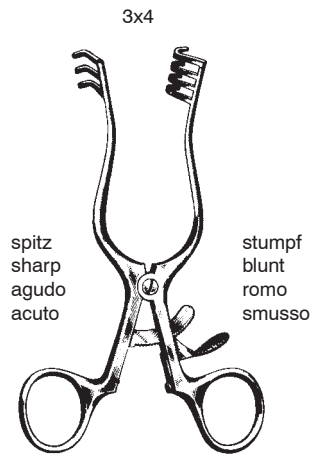

spitz  
sharp  
agudo  
acuto

stumpf  
blunt  
romo  
smusso

WEITLANER  
19670-14 14,0 cm, 5 1/2" 19671-14  
19670-16 16,5 cm, 6 1/2" 19671-16  
19670-20 20,0 cm, 8" 19671-20  
19670-24 24,0 cm, 9 1/2" 19671-24

Wundsperrer  
Retractors  
Separadores  
Divaricatori

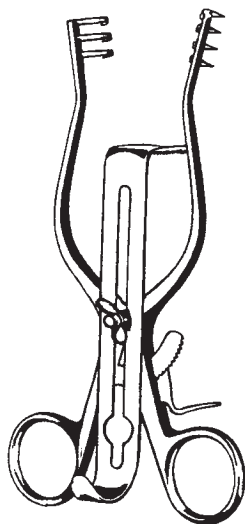

HENLEY  
19675-00 - 19677-32  
16,5 cm, 6 1/2"



19675-00 komplett, stumpf, 3x4 Z. und 3 Valven  
19675-00 complete, blunt, 3x4 teeth and 3 blades  
19675-00 completo, romo, 3x4 dientes y 3 valvas  
19675-00 completo, smusso, 3x4 d. e 3 valve

19676-00 komplett, scharf, 3x4 Z. und 3 Valven  
19676-00 complete, sharp, 3x4 teeth and 3 blades  
19676-00 completo, agudo, 3x4 dientes y 3 valvas  
19676-00 completo con retr. acuto 3x4 d. e 3 valve

19678-05 Retraktor allein, stumpf 3x4 Zähne  
19678-05 Retractor only, blunt 3x4 teeth  
19678-05 Separador solo, romo, 3x4 dientes  
19678-05 Retrattore solo, smusso 3x4 denti

19678-06 Retraktor allein, spitz 3x4 Zähne  
19678-06 Retractor only, sharp 3x4 teeth  
19678-06 Separador solo, agudo, 3x4 dientes  
19678-06 Retrattore solo, acuto 3x4 denti

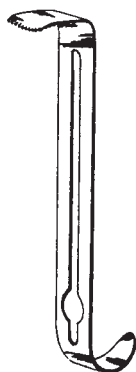

19677-19  
16x19 mm  
5/8" x 3/4"

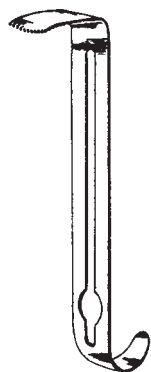

19677-25  
16x25 mm  
5/8" x 1"

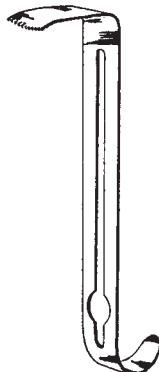

19677-32  
16x32 mm  
5/8" x 1 1/4"

Wundsperrer  
Retractors  
Separadores  
Divaricatori



PLESTER  
19672-11 11 cm, 4 <sup>3</sup>/<sub>8</sub>"  
stumpf - blunt - romo - smusso



PLESTER  
19673-11 11 cm, 4 <sup>3</sup>/<sub>8</sub>"  
stumpf - blunt - romo - smusso



MOLLISON  
19674-15 15 cm, 6"  
scharf - sharp - agudo - acuto



WULLSTEIN  
19675-13 13 cm, 5 <sup>1</sup>/<sub>8</sub>"  
stumpf - blunt - romo - smusso



PLESTER  
19677-13 13 cm, 5 <sup>1</sup>/<sub>8</sub>"  
scharf - sharp - agudo - acuto



MAYO-ADAMS  
19678-16 16,5 cm, 6 <sup>1</sup>/<sub>2</sub>"  
stumpf - blunt - romo - smusso

Wundsperrer  
Retractors  
Separadores  
Divaricatori

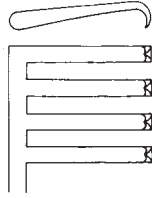
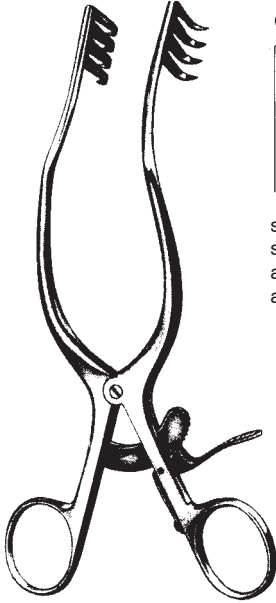

spitz  
sharp  
agudo  
acuto

ANDERSON ADSON  
19679-20 19,5 cm, 7 3/4"



stumpf  
blunt  
romo  
smusso

NORFOLK / NORWICH  
19679-22 22 cm, 8 3/4"



spitz  
sharp  
agudo  
acuto

ADSON  
19680-19 19 cm, 7 1/2" 19681-19

stumpf  
blunt  
romo  
smusso



stumpf  
blunt  
romo  
smusso

TRAVERS  
19681-21 21,5 cm, 8 1/2"

Wundsperrer  
Retractors  
Separadores  
Divaricatori



ADSON  
19682-26 - 19683-26  
26,5 cm, 10 1/2"

spitz  
sharp  
agudo  
acuto

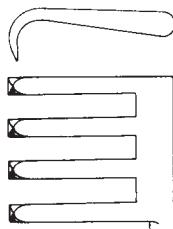

19682-26

stumpf  
blunt  
romo  
smusso

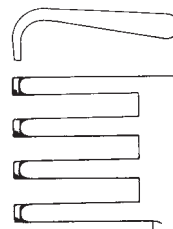

19683-26

- 19684-14 14 cm, 5 1/2"
- 19684-16 16 cm, 6 1/4"
- 19684-20 20 cm, 8"
- 19684-26 26 cm, 10 1/4"

spitz  
sharp  
agudo  
acuto

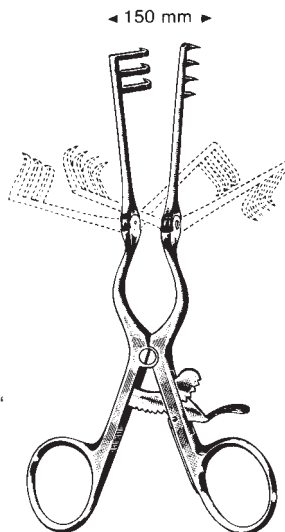

ADSON

- 19685-14 14 cm, 5 1/2"
- 19685-16 16 cm, 6 1/4"
- 19685-20 20 cm, 8"
- 19685-26 26 cm, 10 1/4"

stumpf  
blunt  
romo  
smusso

Wundsperrer  
Retractors  
Separadores  
Divaricatori

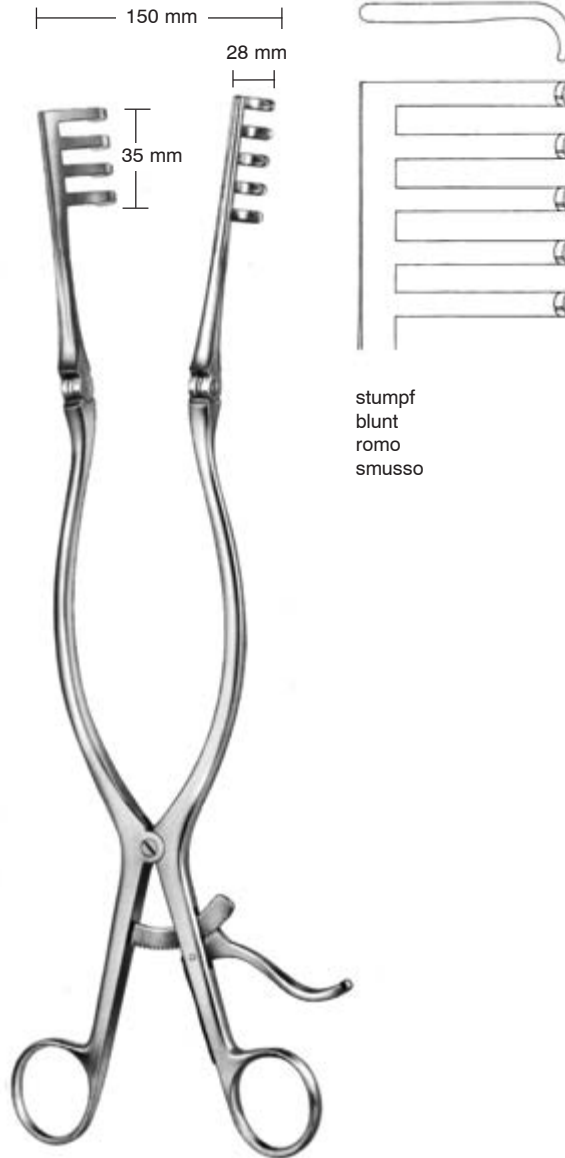

ADSON  
19686-32  
32 cm, 12 3/4"

Wundsperrer  
Retractors  
Separadores  
Divaricatori



BECKMAN-ADSON  
31 cm, 12 1/4"

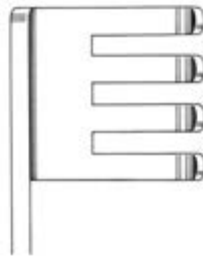

19687-01  
25 x 31 mm

stumpf  
blunt  
romo  
smusso

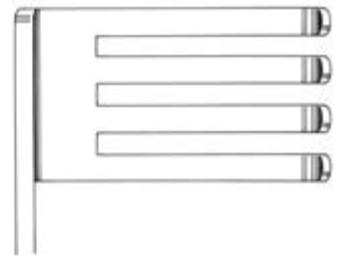

19688-01  
45 x 27 mm

stumpf  
blunt  
romo  
smusso

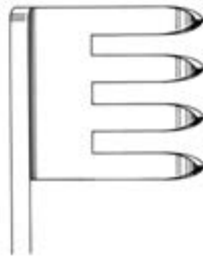

19687-02  
25 x 31 mm

scharf  
sharp  
agudo  
acuto

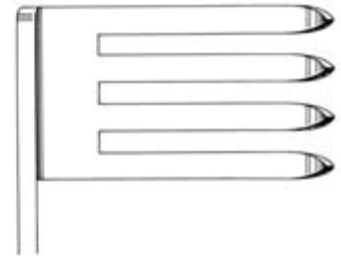

19688-02  
45 x 27 mm

scharf  
sharp  
agudo  
acuto

Wundsperrer  
Retractors  
Separadores  
Divaricatori



MARTIN  
28,5 cm, 11 1/4"

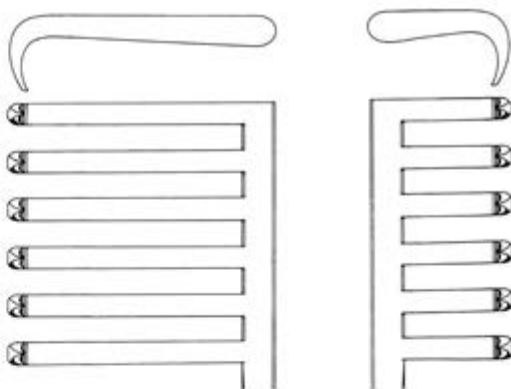

19689-01  
6x6 Zähne

scharf, lange Zähne links  
sharp, long teeth on left side  
agudo, dientes largos a la izquierda  
acuto, denti lunghe a sinistra

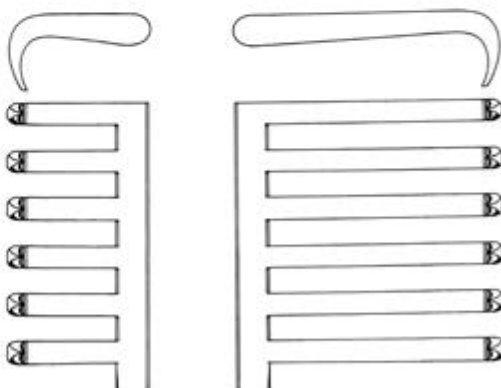

19689-02  
6x6 Zähne

scharf, lange Zähne rechts  
sharp, long teeth on right side  
agudo, dientes largos a la derecha  
acuto, denti lunghe a destra





Wundsperrer  
Retractors  
Separadores  
Divaricatori

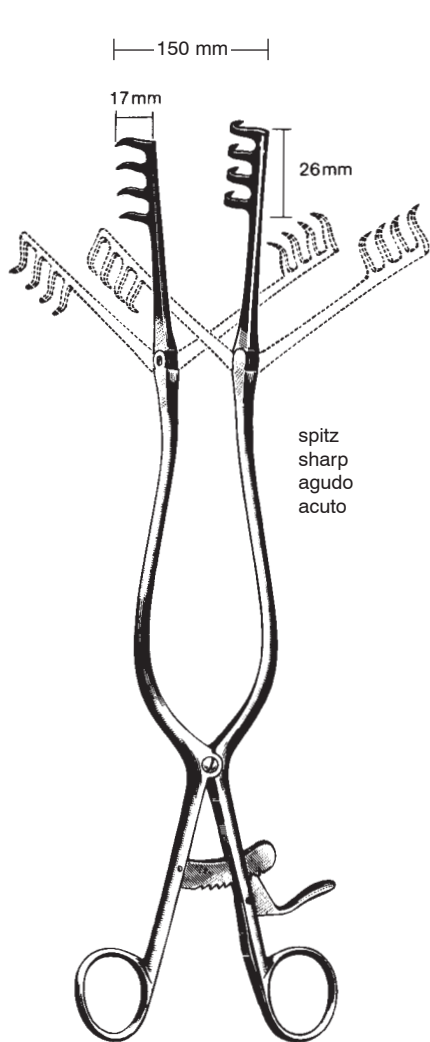

spitz  
sharp  
agudo  
acuto

BECKMANN  
19690-31  
31 cm, 12 1/4"



spitz  
sharp  
agudo  
acuto

BECKMANN-EATON  
19692-32  
32 cm, 12 3/4"

Wundhaken  
Retractors  
Separadores  
Divaricatori



19694-01	20 cm, 8"	50 x 16 mm
19694-02	23 cm, 9"	75 x 25 mm
19694-03	24 cm, 9 1/2"	90 x 50 mm

MEYERDING

Hemilaminectomiespreizer  
 Hemilaminectomy Retractor  
 Separadores para hemilaminectomía  
 Divaricatori per emilaminectomia

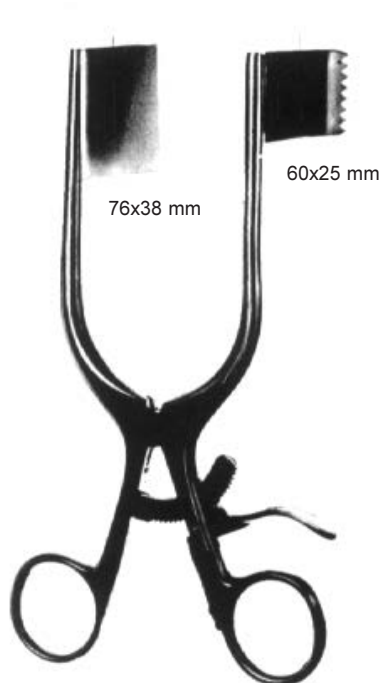

DARLING  
 19696-18 18 cm, 7"

links  
 left  
 a la izquierda  
 a sinistra

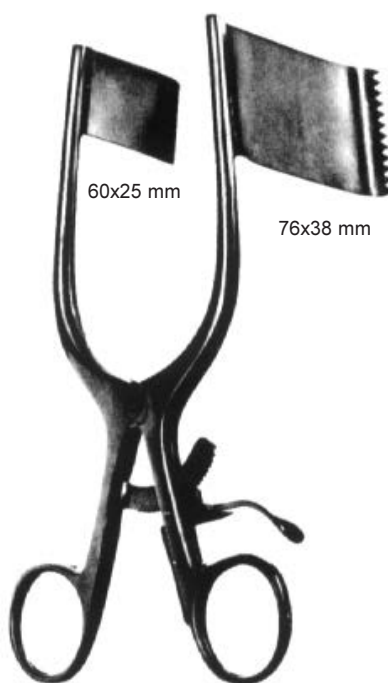

DARLING  
 19698-18 18 cm, 7"

rechts  
 right  
 a la derecha  
 a destra

Cervicalspreizer  
 Cervical Retractor  
 Separador cervical  
 Divaricatore cervicale



CLOWARD  
 25 cm, 10"

spitz  
 sharp  
 agudo  
 acuto



19710-40	40 x 15 / 23 mm
19710-45	45 x 15 / 23 mm
19710-50	50 x 15 / 23 mm
19710-55	55 x 15 / 23 mm
19710-60	60 x 15 / 23 mm

19710-01  
 Sperrer, alleine  
 Retractor, only  
 Retractor, suelto  
 Divaricatore solo

19710-00  
 Sperrer komplett mit 5 Valven spitz  
 Retractor complete with 5 blades sharp  
 Separador completo con 5 valvas agudas  
 Divaricatore completo con 5 valve acute

Cervicalspreizer  
 Cervical Retractor  
 Separador cervical  
 Divaricatore cervicale



CLOWARD  
 25 cm, 10"

stumpf  
 blunt  
 romo  
 smusso



19711-40	40 x 15 / 23 mm
19711-45	45 x 15 / 23 mm
19711-50	50 x 15 / 23 mm
19711-55	55 x 15 / 23 mm
19711-60	60 x 15 / 23 mm

19710-01  
 Sperrer, alleine  
 Retractor, only  
 Retractor, suelto  
 Divaricatore solo

19712-00  
 Sperrer komplett mit 5 Valven stumpf  
 Retractor complete with 5 blades blunt  
 Separador completo con 5 valvas romas  
 Divaricatore completo con 5 valve smusse

Cervicalspreizer  
 Cervical Retractor  
 Separador cervical  
 Divaricatore cervicale

spitz  
 sharp  
 agudo  
 acuto



- 19710-40 40 x 15 / 23 mm
- 19710-45 45 x 15 / 23 mm
- 19710-50 50 x 15 / 23 mm
- 19710-55 55 x 15 / 23 mm
- 19710-60 60 x 15 / 23 mm



CLOWARD  
 16 cm, 6 1/4"

- 19711-01  
 Sperrer, alleine  
 Retractor, only  
 Retractor, suelto  
 Divaricatore solo

- 19711-00  
 Sperrer komplett mit 5 Valven spitz  
 Retractor complete with 5 blades sharp  
 Separador completo con 5 valvas agudas  
 Divaricatore completo con 5 valve acute

Cervicalspreizer  
 Cervical Retractor  
 Separador cervical  
 Divaricatore cervicale



CLOWARD  
 16 cm, 6 1/4"

stumpf  
 blunt  
 romo  
 smusso



19711-40	40 x 15 / 23 mm
19711-45	45 x 15 / 23 mm
19711-50	50 x 15 / 23 mm
19711-55	55 x 15 / 23 mm
19711-60	60 x 15 / 23 mm

19711-01  
 Sperrer, alleine  
 Retractor, only  
 Retractor, suelto  
 Divaricatore solo

19713-00  
 Sperrer komplett mit 5 Valven stumpf  
 Retractor complete with 5 blades blunt  
 Separador completo con 5 valvas romas  
 Divaricatore completo con 5 valve smusse



Cervicalspreizer  
 Cervical Retractor  
 Separador cervical  
 Divaricatore cervicale

90 mm, 3 1/2"



CASPAR  
 19721-15

165 mm, 5 1/2"

Sperrer, alleine  
 Retractor, only  
 Retractor, suelto  
 Divaricatore solo



19726-01

Blätter-Wechselpinzette  
 Blade ejector  
 Pinza para cambiar hojas  
 Pinze per cambiare valve

19721-00  
 Sperrer komplett mit 5 Valven stumpf  
 Retractor complete with 5 blades blunt  
 Separador completo con 5 valvas romas  
 Divaricatore completo con 5 valve smusse

- 19738-45 45 x 23 mm
- 19738-50 50 x 23 mm
- 19738-55 55 x 23 mm
- 19738-60 60 x 23 mm
- 19738-65 65 x 23 mm



Lumbal-Wundspreizer  
Lumbal Retractors  
Separadores lumbales autoestáticos  
Divaricatori autostatici lombari



19745-40  
40 mm, 1 1/2"



19745-45  
45 mm, 1 3/4"



19745-60  
60 mm, 2 1/4"



19745-50  
50 mm, 2"



19745-65  
65 mm, 2 1/2"



19745-55  
55 mm, 2 1/8"



19745-70  
70 mm, 2 3/4"

CASPAR  
19744-00  
komplett mit 7 Blätter  
compl. incl. 7 blades  
completo con 7 valvas  
complete di 7 valve

19744-17  
ohne Blätter  
without blades  
sin valvas  
senza valve

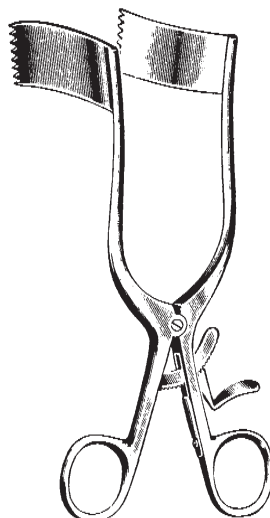

MEYERDING  
17 cm, 6 3/4"

19748-01 2,5 x 3,2 cm  
19748-02 2,5 x 5,4 cm  
19748-03 1,9 x 6,0 cm  
19748-04 2,5 x 6,0 cm

Bauchdeckenhalter  
 Abdominal Retractors  
 Separadores abdominales  
 Divaricatori addominali

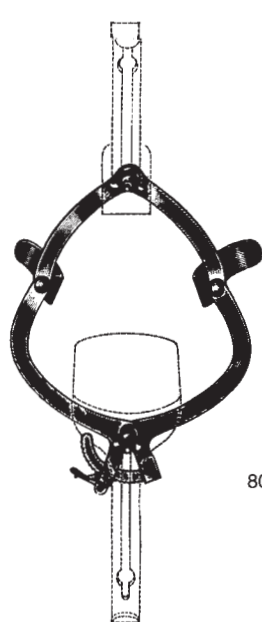

O'SULLIVAN - O'CONNOR  
 19754-00  
 compl.

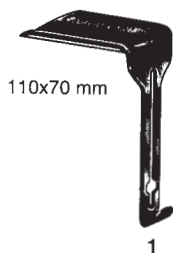

110x70 mm

1



80x45 mm

2



80x45 mm

3

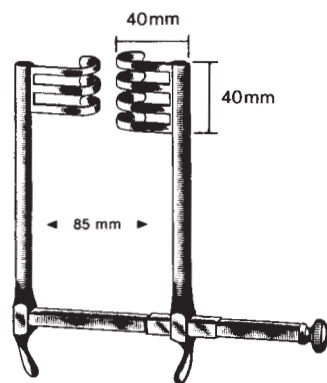

40mm

40mm

85 mm

FRAZIER  
 19758-85

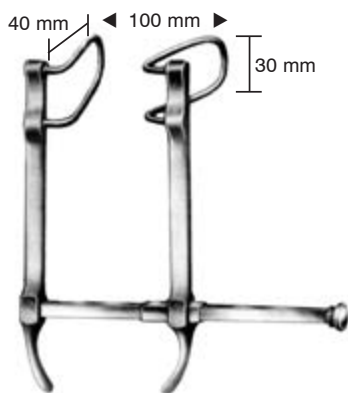

40 mm

100 mm

30 mm

BABY GOSSET  
 19759-00

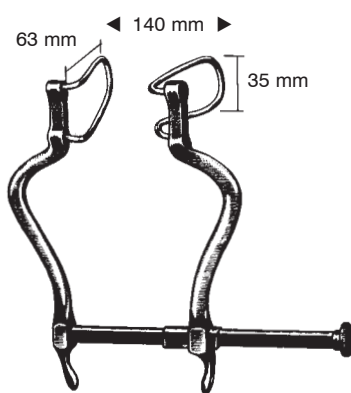

63 mm

140 mm

35 mm

GOSSET  
 19760-14

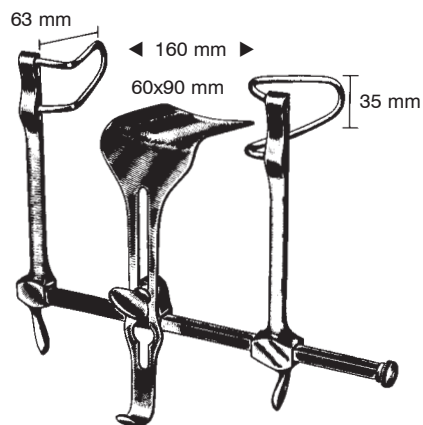

63 mm

160 mm

60x90 mm

35 mm

GOSSET  
 19762-16

Bauchdeckenhalter  
Abdominal Retractors  
Separadores abdominales  
Divaricatori addominali

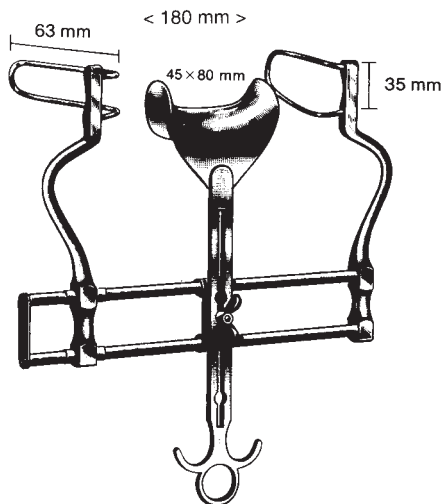

BALFOUR  
19764-18  
18 cm, 7"

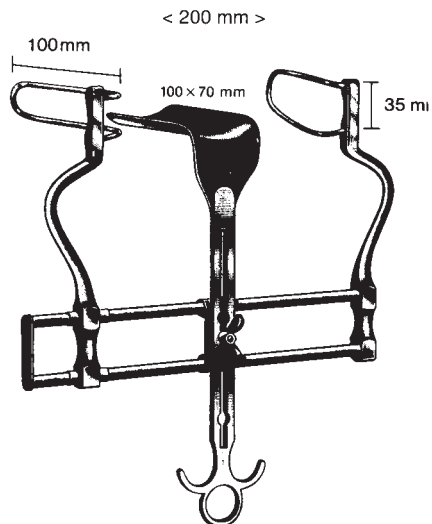

BALFOUR  
19764-20  
20 cm, 8"

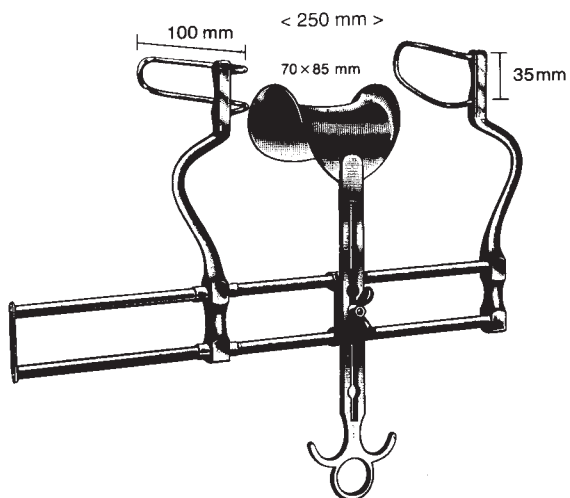

BALFOUR  
19764-25  
25 cm, 10"

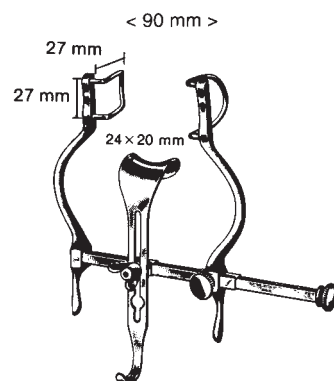

BALFOUR Baby  
19766-90  
9 cm, 3 1/2"

Bauchdeckenhalter  
Abdominal Retractors  
Separadores abdominales  
Divaricatori addominali

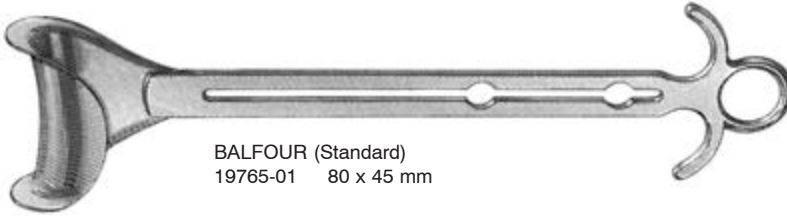

BALFOUR (Standard)  
19765-01 80 x 45 mm

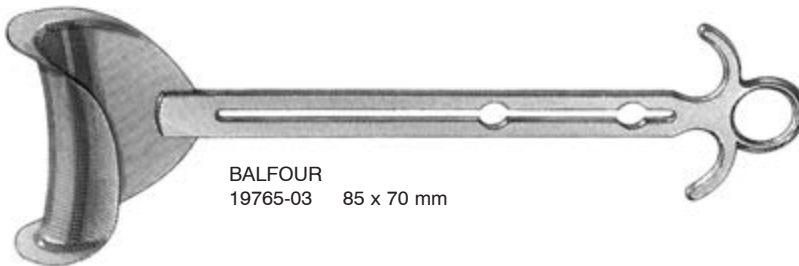

BALFOUR  
19765-03 85 x 70 mm

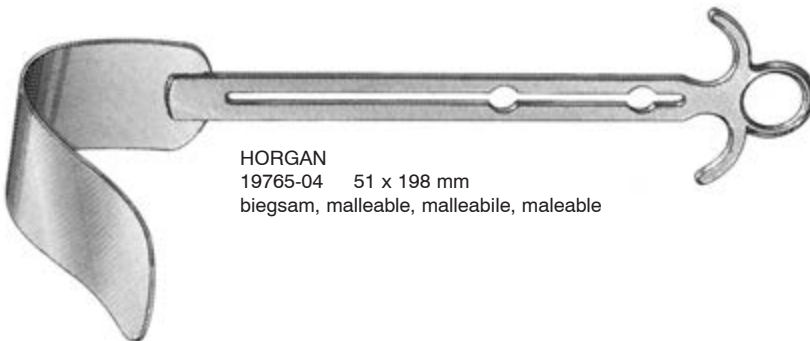

HORGAN  
19765-04 51 x 198 mm  
biegsam, malleable, malleabile, maleable

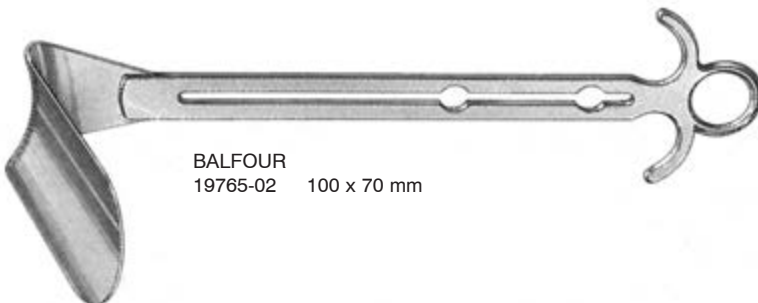

BALFOUR  
19765-02 100 x 70 mm

Bauchdeckenhalter  
Abdominal Retractors  
Separadores abdominales  
Divaricatori addominali



19767-01  
Drahtvalven 5 cm (1.96") tief (Paar)  
Fenestrated blades 5 cm (1.96") deep (pair)  
Valvas de alambre 5 cm (1.96") profundidad (par)  
Valve di filo profondità 5 cm (1.96") (paio)



19767-02  
Drahtvalven 7,5 cm (2,95") tief (Paar)  
Fenestrated blades 7,5 cm (2,95") deep (pair)  
Valvas de alambre 7,5 cm 2,95") profundidad (par)  
Valve di filo profondità 7,5 cm (2,95") (paio)



BALFOUR-US  
19767-18  
19767-25  
komplett  
complete  
completo

Bauchdeckenhalter  
Abdominal Retractors  
Separadores abdominales  
Divaricatori addominali

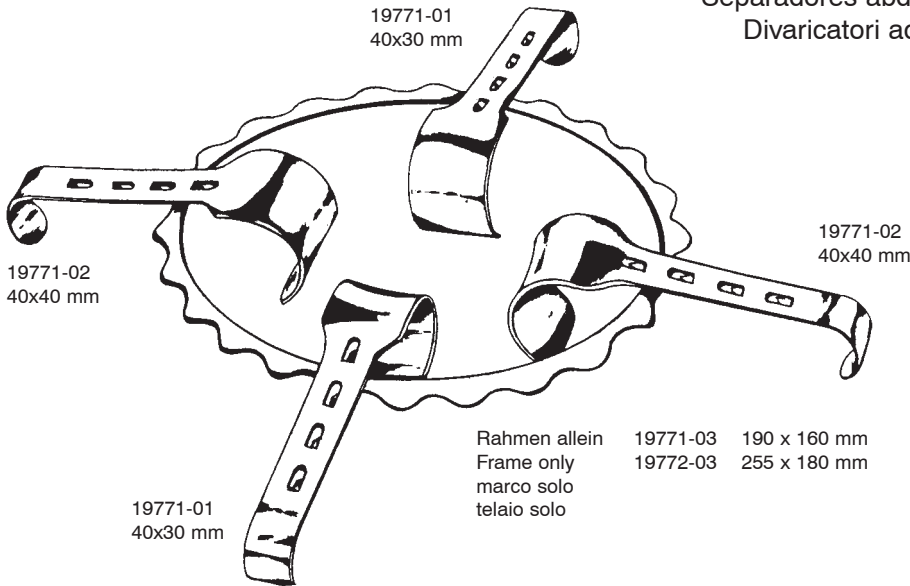

DENIS-BROWNE

19771-00 compl. Pediatric/pediatrico 190 x 160 mm  
19772-00 compl. Adult/adulto 255 x 180 mm

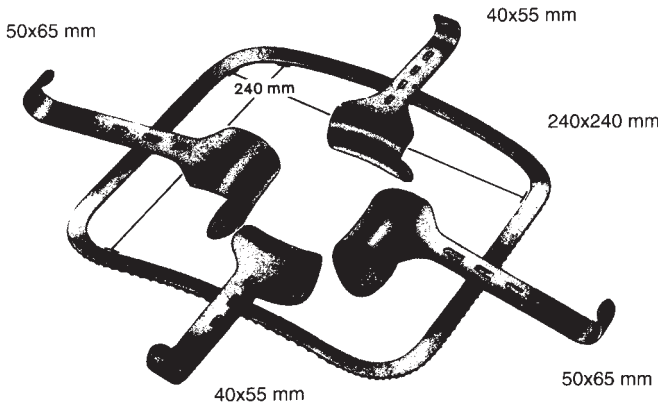

KIRSCHNER



19781-55  
40 x 55 mm breit



19781-65  
50 x 65 mm breit

19782-00 Kirschner Bauchdeckenhalter komplett bestehend aus:  
Kirschner Abdominal Retr. complete consisting of:  
Kirschner separador abdominal completo compuesto de:  
Kirschner Divaricatore addominale completo, composto da:

19781-55 2 Rahmenhaken / 2 Hook-on Retr. / 2 separadores / 2 divaricatori 40 x 55 mm

19781-65 2 Rahmenhaken / 2 Hook-on Retr. / 2 separadores / 2 divaricatori 50 x 65 mm

19783-24 Rahmen fest / frame rigid / marco rigido / telaio rigido 240 x 240 mm

Bauchdeckenhalter  
 Abdominal Retractors  
 Separadores abdominales  
 Divaricatori addominali



19780-01 + 19770-01

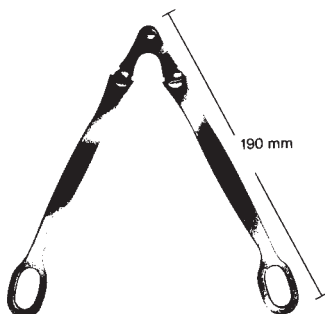

ROCHARD  
 19780-01

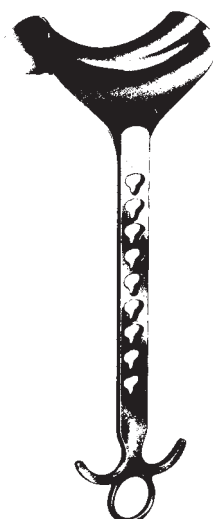

ROCHARD  
 31 cm, 12 1/4"  
 19770-01 48x90 mm  
 19770-02 48x105 mm  
 19770-03 48x120 mm  
 19770-04 48x135 mm  
 19770-05 48x155 mm

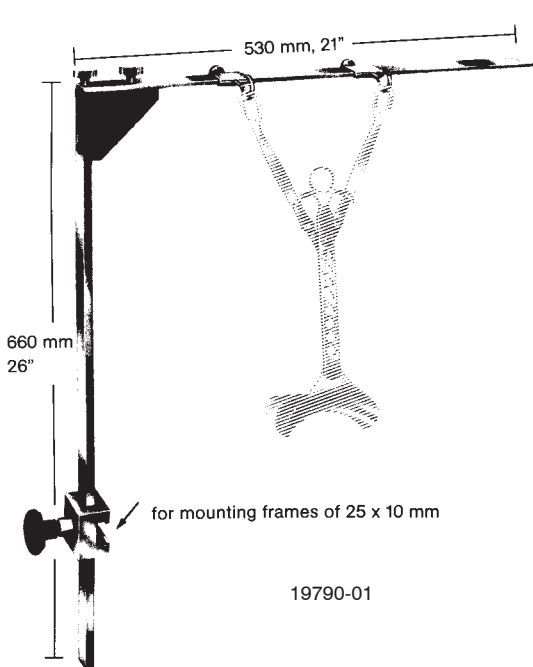

19790-01

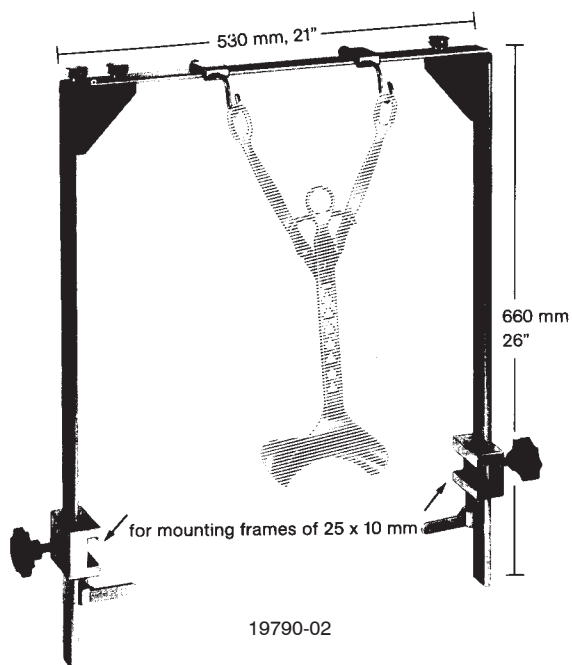

19790-02



Bauchdeckenhalter  
Abdominal Retractors  
Separadores abdominales  
Divaricatori addominali

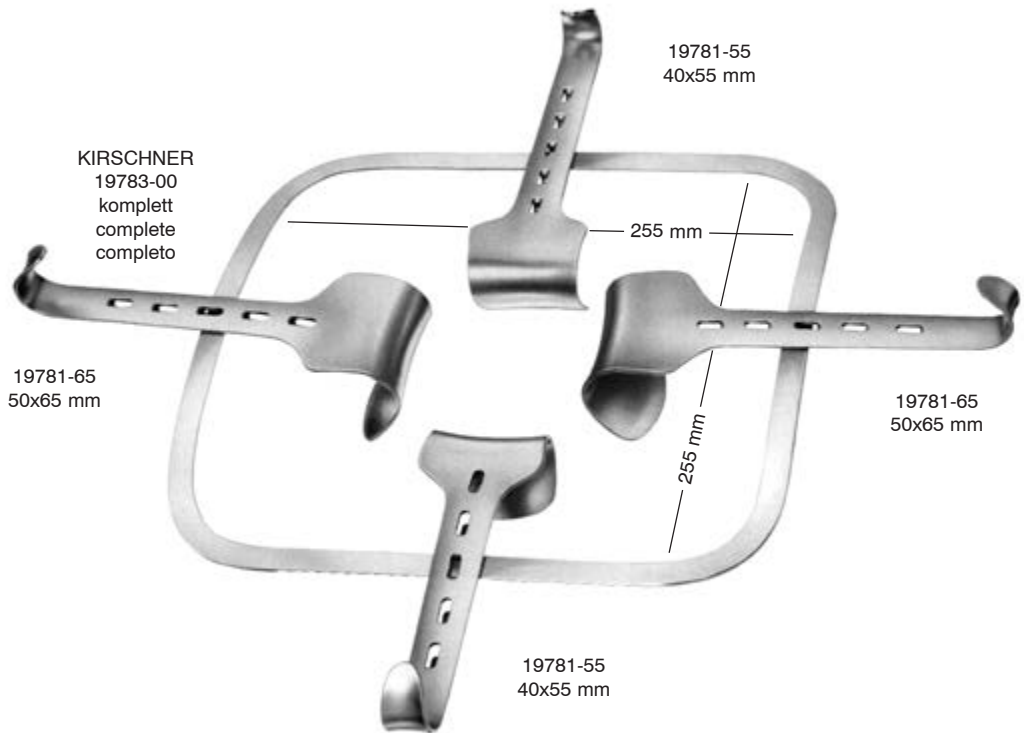

19783-01 250x250 mm  
zusammenlegbarer Rahmen  
folding frame  
marco  
telaio

Bauchdeckenhalter  
 Abdominal Retractors  
 Separadores abdominales  
 Divaricatori addominali

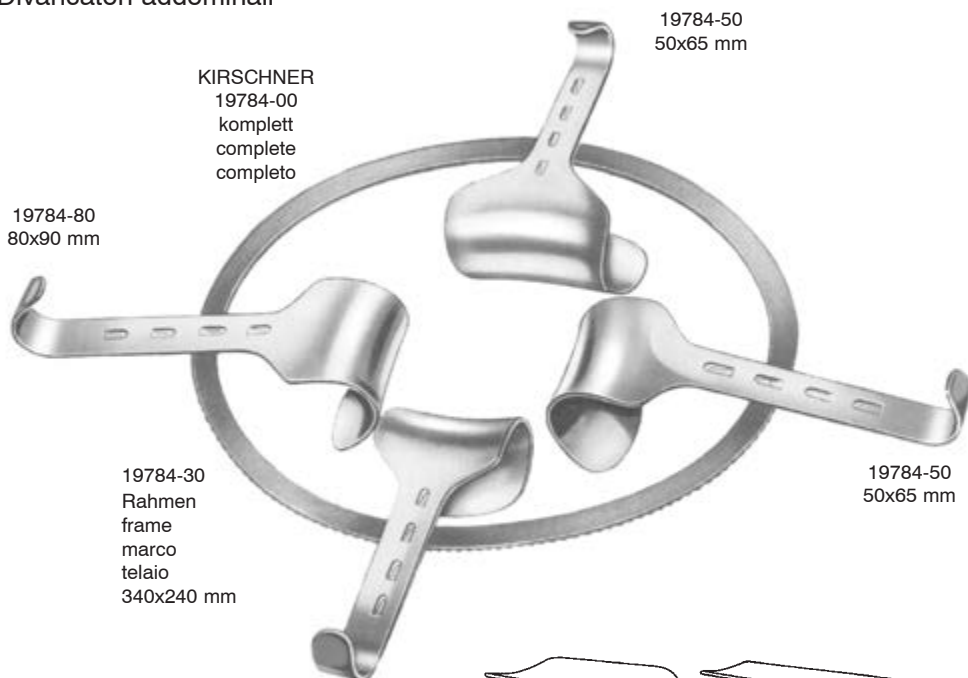

KIRSCHNER  
 19784-00  
 komplett  
 complete  
 completo

19784-50  
 50x65 mm

19784-80  
 80x90 mm

19784-30  
 Rahmen  
 frame  
 marco  
 telaio  
 340x240 mm

19784-50  
 50x65 mm

19784-50  
 50x65 mm

für Darm und Blase  
 for intestine and bladder  
 para intestino y vejiga  
 per intestino e vescica

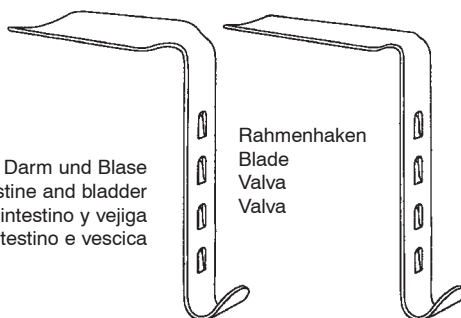

Rahmenhaken  
 Blade  
 Valva  
 Valva

19784-98  
 98x50 mm

19784-99  
 105x35 mm

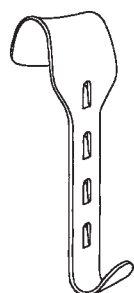

19784-40  
 40x55 mm

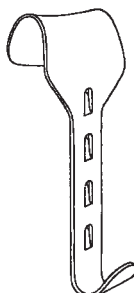

19784-50  
 50x65 mm

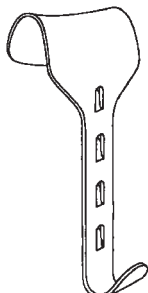

19784-60  
 60x85 mm

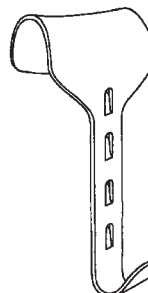

19784-78  
 78x65 mm

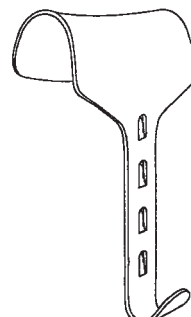

19784-80  
 80x90 mm



Arm System  
 Arm System  
 Sistema de brazo  
 Sistema braccio



19795-01

Armsystem Radius 310/420 mm komplett mit Wundhakenhalter und U-Stativ Ø 16 mm, 400 mm hoch, 400 mm breit, 170 mm tief (ohne Klemmsockel).

Arm System, radius 310/420 mm, including retractor and U-stand Ø 16 mm, 400 mm high, 400 mm wide, 170 mm deep (without clamp socket).



19795-02

Armsystem Radius 310/420 mm komplett mit Stativ, Klemmsockel und Endoskophalter Ø 8/10 mm.

Arm System, radius 310/420 mm, including stand, clamp, endoscope holder Ø 8/10 mm.



19798-01

Zweischlauchhalterung aus Aluminium  
 Double tube holder made of aluminium



19798-02

Endoskophalterung Universal  
 Endoscope holder Universal  
 Ø 3-10 mm



19798-03

Universelle  
 Wundhakenhalterung  
 Universal retractor holder

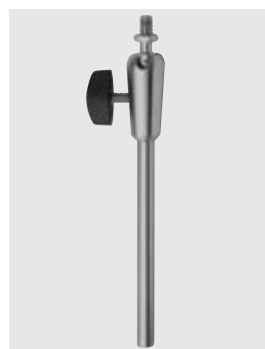

19798-04

Gelenkverlängerung  
 180 mm lang mit Feststellung  
 Extended articulation  
 180 mm long, lockable

Arm System  
 Arm System  
 Sistema de brazo  
 Sistema braccio



**19799-03**  
 Leichtmetall-Klemmsockel Spannweite 35 mm, für ein Schraubstativ mit  $\varnothing$  16 mm/M10, für Schienen 25/35 x 8/10 und Röhre  $\varnothing$  12 - 35 mm. Clamp socket made of light metal, holding width 35 mm, for screw stand  $\varnothing$  16 mm/M10, for rails 25/35 x 8/10 and tubes  $\varnothing$  12 - 35 mm.



**19799-04**  
 Leichtmetall-Klemmsockel Spannweite 50 mm, für ein höhenverstellbares Stativ  $\varnothing$  16 mm, für Schienen 25/35 x 8/10 und Röhre  $\varnothing$  12 - 35 mm. Clamp socket made of light metal, holding width 50 mm, for height-adjustable stand  $\varnothing$  16 mm, for rails 25/35 x 8/10 and tubes  $\varnothing$  12 - 35 mm.



**19799-05**  
 Klemmsockel aus rostfreiem Stahl, für ein höhenverstellbares Stativ  $\varnothing$  16 mm, elektrisch isoliert bis 4,5 kV AC, Spannweite 50 mm für Schienen 25/32 x 8/12 mm. Clamp socket made of stainless steel, for height-adjustable stand  $\varnothing$  16 mm, electrically insulated up to 4.5 kV AC, holding width of 50 mm for rails 25/32 x 8/12 mm.



**19799-06**  
 Leichtmetall-Klemmsockel Spannweite 50 mm, für ein Schraubstativ mit  $\varnothing$  16 mm/M10, für Schienen 25/35 x 8/10 und Röhre  $\varnothing$  12 - 35 mm. Clamp socket made of light metal, holding width 50 mm, for screw stand  $\varnothing$  16 mm/M10, for rails 25/35 x 8/10 and tubes  $\varnothing$  12 - 35 mm.

Bauchdeckenhalter, Wundsperrer  
 Abdominal Retractors, Retractors  
 Separadores abdominales, Separadores  
 Divaricatori addominali, Divaricatori



DOYEN

28 cm, 11"

19800-01	48x 90 mm
19800-02	48x105 mm
19800-03	48x120 mm
19800-04	48x135 mm

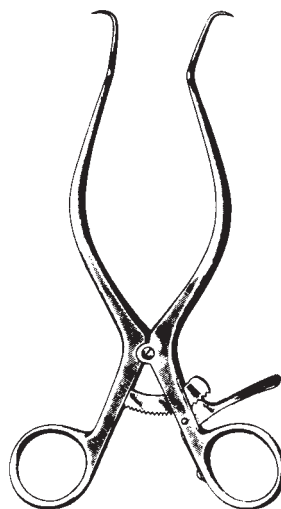

GELPI

19802-09	9 cm, 3 1/2"
19802-11	11 cm, 4 3/8"
19802-14	14 cm, 5 1/2"
19802-16	16 cm, 6 1/4"
19802-18	18 cm, 7"



DE BAKEY

19803-14  
14,5 cm, 5 3/4"

Wundsperrer  
Retractors  
Separadores  
Divaricatori

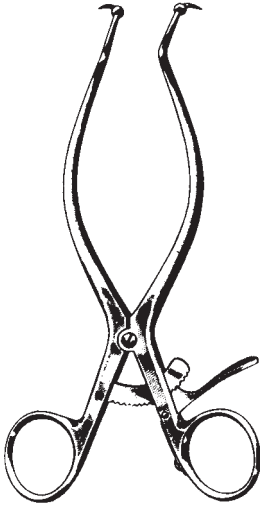

GELPI  
19804-18  
18 cm, 7"



JACKSON BURROWS  
19805-18  
18,5 cm, 7 1/4"

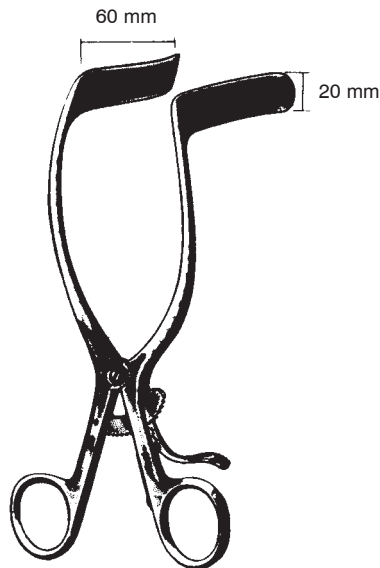

RIGBY  
19806-18  
18 cm, 7"

Bauchdeckenhalter  
Abdominal Retractors  
Separadores abdominales  
Divaricatori addominali



COLLIN  
19810-22  
komplett  
complete  
completo

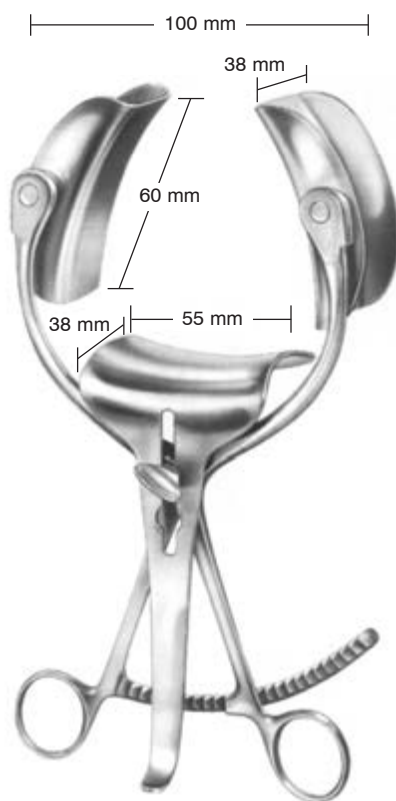

COLLIN  
19812-60  
komplett  
complete  
completo



Bauchdeckenhalter  
 Abdominal Retractors  
 Separadores abdominales  
 Divaricatori addominali

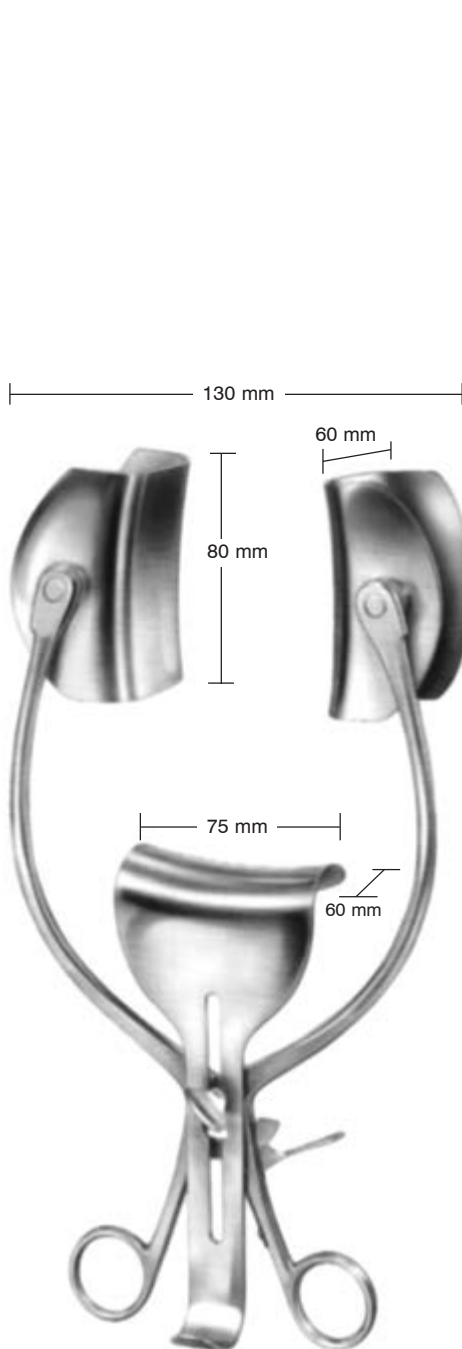

COLLIN Loktite  
 19816-00 31 cm, 12 1/4"  
 komplett / complete / completo

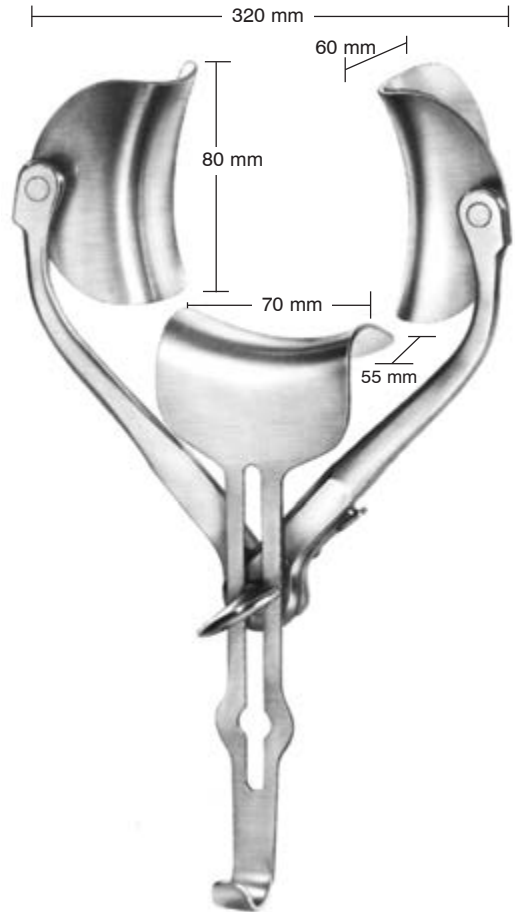

RICARD  
 19813-00 30 cm, 11 3/4"  
 komplett / complete / completo

Back holder Abdominal Retractor  
Operation Table Set

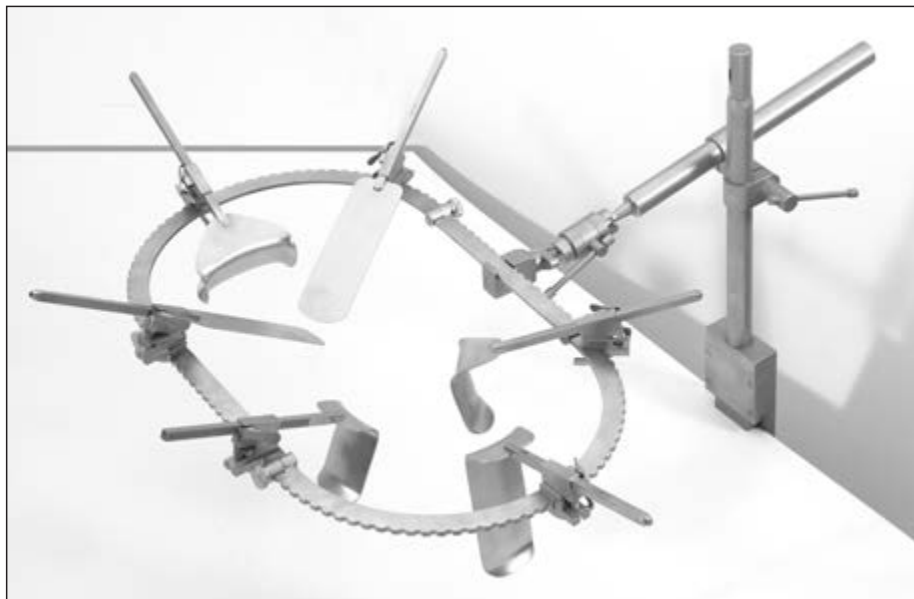

Complete Fixed Abdominal Retractor Set  
Set completo divaricatore addominale con sistema di montaggio modulare

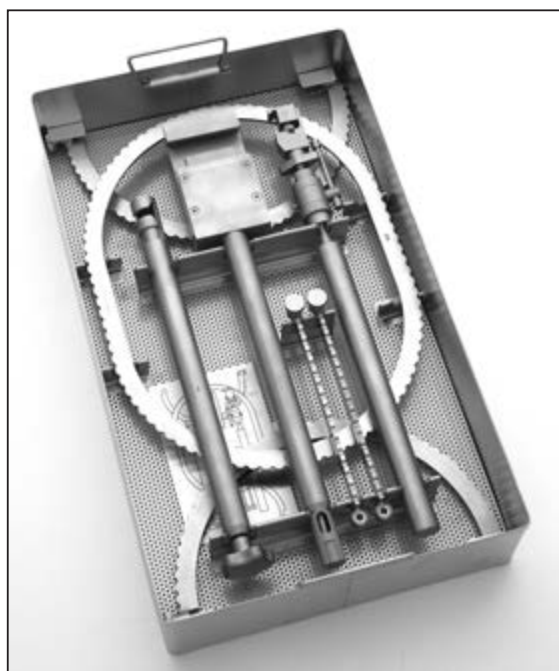

The many components of the **Back holder Abdominal Retractor Operation Table Set**

can all be neatly arranged into autoclave sized containers with diagrams that direct instrument handlers on proper placement of each component.

*A major convenience in care and maintenance  
of the Retractor Set*

**Sterilization Container & Baskets**

Description	Product No
Table Fixation & Ring Case	19820-90
Blade & Accessories Case	19820-91

**Back holder Abdominal Retractor  
Operation Table Set**

<b>Description</b>	<b>Product No</b>	<b>Composto da</b>	
Complete Abdominal Retractor Set	19820-99	Accoppiatore	19821-01
		Barra orizzontale	19821-02
<i>Includes</i>		Morsetto di accoppiamento	19821-04
Table Post	19821-01	Anello ovale	19820-02
Horizontal Bar	19821-02	No. 2 retrattori malleabili, 51x152 mm	19825-06
1" Post Coupling	19821-04	No. 2 Valve Kelly, dim. 51x76 mm	19822-23
Oval Ring	19820-02	Valva Kelly	19822-24
2" X 6" Malleable Retractor (2 ea)	19825-06	Valva Balfour	19823-33
2" X 3" Kelly Retractor (2 ea)	19822-23	Morsetto trasportabile con trasporto ad intervallo progressivo di 2 mm	19820-10
2" X 4" Kelly Retractor	19822-24	Morsetto articolato multidisciplinare con funzione movimento assiale orizzontale e verticale	19820-20
Balfour Retractor	19833-33	Anello ovale 266x367 mm	19820-02
Ratchet Mechanism (2 ea)	19820-10	Anello a segmento 266x495 mm	19820-03
Tilt Ratchet Mechanism (6 ea)	19820-20	Retrattore malleabile 38x152 mm	19824-06
Segmented Ring	19820-03	Retrattore malleabile 76x152 mm	19826-06
1 1/2" X 6" Malleable Retractor	19824-06	Valva Kelly, 51x127 mm	19822-25
3" x 6" Malleable Retractor	19826-06	Valva Kelly, 51x152 mm	19822-26
2" X 5" Kelly Retractor	19822-25	Barra flessibile orizzontale	19821-03
2" X 6" Kelly Retractor	19822-26	Retrattore Harrington 63x143 mm	19831-25
Horizontal Flex Bar	19821-03	Retrattore con punta Gelpi	19834-01
Harrington Retractor	19831-25		
Gelpi Retractor	19834-01		
<i>Accessories</i>		<i>Accessori:</i>	
Table Fixation & Ring Case	19820-90	Container vuoto in acciaio inox dotato con griglia interna	
Blades & Accessories Case	19820-91	Descrizione	
		Container in acciaio inox dotato di griglia interna per Accessori di fissazione, anelli e barre	19820-90
		Container in acciaio inox dotato di griglia interna per morsetti e divaricatori	19820-91



### Malleable Retractors with Protective Edge



Description	Product No
1 1/2" x 6" 38 x 152 mm	19824-06
2" x 6" 51 x 152 mm	19825-06
3" x 6" 76 x 152 mm	19826-06

### Specialty Retractors

Description	Product No
Balfour Retractor 2 5/8" x 3" 67 x 76 mm	19833-33
Gelpi Point Retractor	19834-01



### Harrington Retractors

Description	Product No
Blade 2.5" x 5 5/8" 63 x 143 mm	19831-25

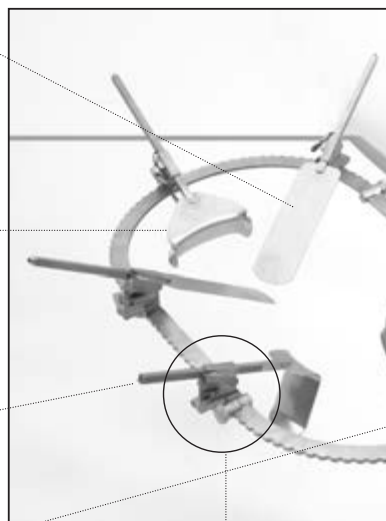

Description	Product No
Blade 2" x 1 1/2" 51 x 38 mm	19822-21
Blade 2" x 2" 51 x 51 mm	19822-22
Blade 2" x 2 1/2" 51 x 64 mm	19822-22L
Blade 2" x 3" 51 x 76 mm	19822-23
Blade 2" x 4" 51 x 102 mm	19822-24
Blade 2" x 5" 51 x 127 mm	19822-25
Blade 2" x 6" 51 x 152 mm	19822-26



Description	Product No
Blade 1" x 1 1/2" 25 x 38 mm	19822-01
Blade 1" x 2 1/2" 25 x 63 mm	19822-02



**Tilt Ratchet Mechanism** allows extensions or retractions along the horizontal axis and allows vertical movement of retractor blade with a second ratchet

**Product No** 19820-20

**Table Mounting Components**

Description	Product No
1" Post Coupler	19821-04

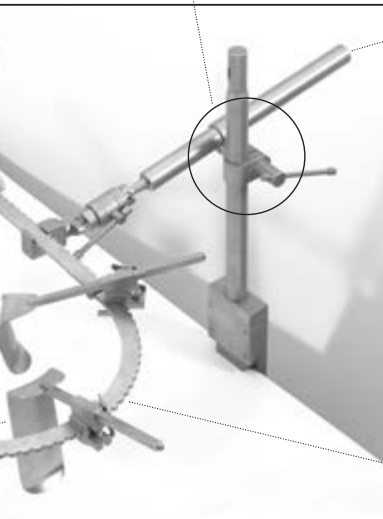

**Fixed Ratchet Mechanism** allows extension or retraction along the horizontal axis at 2mm intervals

**Product No** 19820-10

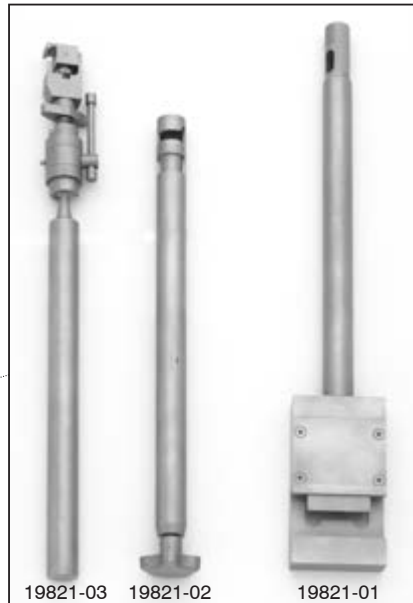

**Table Mounting Components**

Table Post	19821-01
Horizontal Bar	19821-02
Horizontal Flex Bar	19821-03



**Retractor Rings**

Description	Product No
Oval Ring 10.5 x 14.5 inch / 266 x 367 mm	19820-02
Segmented Ring 10.5 x 19.5 inch / 266 x 495 mm (Consists of one 10.5 inch Round Ring and two 8 inch straight segments)	19820-03

Laminektomiespreizer  
Laminectomy Retractors  
Separadores para laminectomia  
Divaricatori per laminectomia



SCOVILLE-HAVERFIELD  
19910-00  
Rahmen allein  
Frame only  
Marco solo  
Telaio solo



SCOVILLE  
19911-00  
Rahmen allein  
Frame only  
Marco solo  
Telaio solo



SCOVILLE  
50 mm, 2"  
19912-50



SCOVILLE  
70 mm, 2 <sup>3</sup>/<sub>4</sub>"  
19912-70



SCOVILLE  
19914-41 41 x 38 mm  
19914-67 67 x 44 mm



TAYLOR  
19915-48 48 x 50 mm  
19915-64 64 x 50 mm  
19916-64 64 x 64 mm  
19916-80 80 x 57 mm



SCOVILLE  
50 mm, 2"  
19913-50



SCOVILLE  
70 mm, 2 <sup>3</sup>/<sub>4</sub>"  
19913-70



SCOVILLE  
19917-64 64 x 25 mm  
19918-64 64 x 50 mm  
19918-88 88 x 25 mm

Wundhaken für plastische Chirurgie  
 Retractors for plastic surgery  
 Separadores para cirugía plástica  
 Divaricatore per chirurgia plastica



TEBBETTS

19980-01	80 mm x 16 mm
19980-02	100 mm x 25 mm
19980-03	120 mm x 25 mm
19980-04	120 mm x 30 mm
19980-05	150 mm x 25 mm
19980-06	150 mm x 30 mm

mit Kaltlicht + Absaugung  
 with cold light + aspiration  
 con luz fria + aspiracion  
 con luce fredda + aspirazione



FERRIERA

19960-01	80 mm x 16 mm
19960-02	100 mm x 25 mm
19960-03	120 mm x 25 mm
19960-04	120 mm x 30 mm
19960-05	150 mm x 25 mm
19960-06	150 mm x 30 mm

Wundhaken für plastische Chirurgie  
 Retractors for plastic surgery  
 Separadores para cirugía plástica  
 Divaricatore per chirurgia plastica



22 x 54 mm

37 x 70 mm

**BREAST**  
 19970-01  
 31 cm, 12 1/4"



70 mm

**CORONAL**  
 19980-18  
 18 cm, 7"



150 mm

**YANCOSKIE**  
 19990-18  
 18 cm, 7"



**FREEMAN**  
 19995-38 18 cm, 7"  
 38 mm, 1 1/2" wide  
 19995-22 18 cm, 7"  
 22 mm, 7/8" wide



**ANDERSON**  
 19998-03 12 cm, 4 3/4" 3 Zähne  
 3 prongs  
 3 dientes  
 3 uncini  
 19998-05 12 cm, 4 3/4" 5 Zähne  
 5 prongs  
 5 dientes  
 5 uncini



Sonden  
Probes, Directors  
Sondas, estiletes  
Sonde, specilli



2 mm ø

11,5 cm, 4 1/2" 21102-11  
13,0 cm, 5 1/8" 21102-13  
14,5 cm, 5 3/4" 21102-14  
16,0 cm, 6 1/4" 21102-16  
18,0 cm, 7" 21102-18  
20,0 cm, 8" 21102-20  
25,0 cm, 10" 21102-25



1 mm ø

21104-11  
21104-13  
21104-14  
21104-16  
21104-18  
21104-20  
21104-25



2 mm ø

21106-11  
21106-13  
21106-14  
21106-16  
21106-18  
21106-20  
21106-25

 21108-14  
14,5 cm, 5 3/4"

 BRODIE  
21109-18  
18 cm  
7"

13,0 cm, 5 1/8" 21110-13  
14,5 cm, 5 3/4" 21110-14  
16,0 cm, 6 1/4" 21110-16  
18,0 cm, 7" 21110-18  
20,0 cm, 8" 21110-20

 DOYEN  
21111-14  
14 cm  
5 1/2"

 21112-14  
14,5 cm  
5 3/4"

 STACKE  
21115-10  
10,5 cm  
4.1"

 NELATON  
21120-16  
16 cm  
6 1/4"

 FISH  
21121-14  
14 cm, 5 1/2"  
21121-18  
18 cm, 7"

 WATSON-CHEYNE  
21122-13  
13 cm, 5 1/8"  
21122-18  
18 cm, 7"

Fistelsonden  
Fistula Probes  
Sondas para fistula  
Sonde per fistole



LOCKHART-MUMMERY  
21125-01  
16,5 cm, 6 1/2"

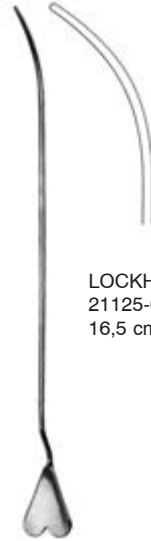

LOCKHART-MUMMERY  
21125-02  
16,5 cm, 6 1/2"

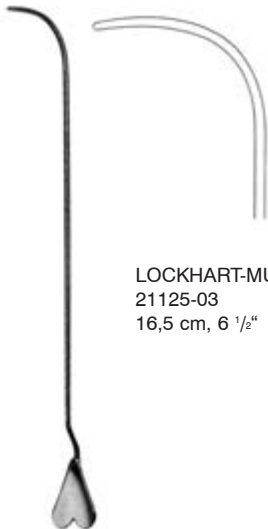

LOCKHART-MUMMERY  
21125-03  
16,5 cm, 6 1/2"

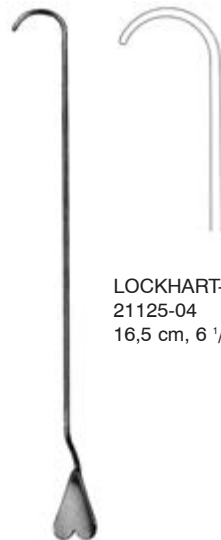

LOCKHART-MUMMERY  
21125-04  
16,5 cm, 6 1/2"

Krampfader-Besteck in Metalletui  
 Varicose vein probe set in metal case  
 Juego para várices en estuche de metal  
 Astuccio per varici in scatola di metallo

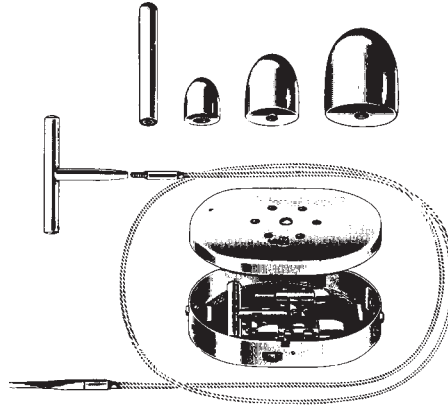

NABATOFF  
 21150-00  
 135x100x25 mm  
 compl.

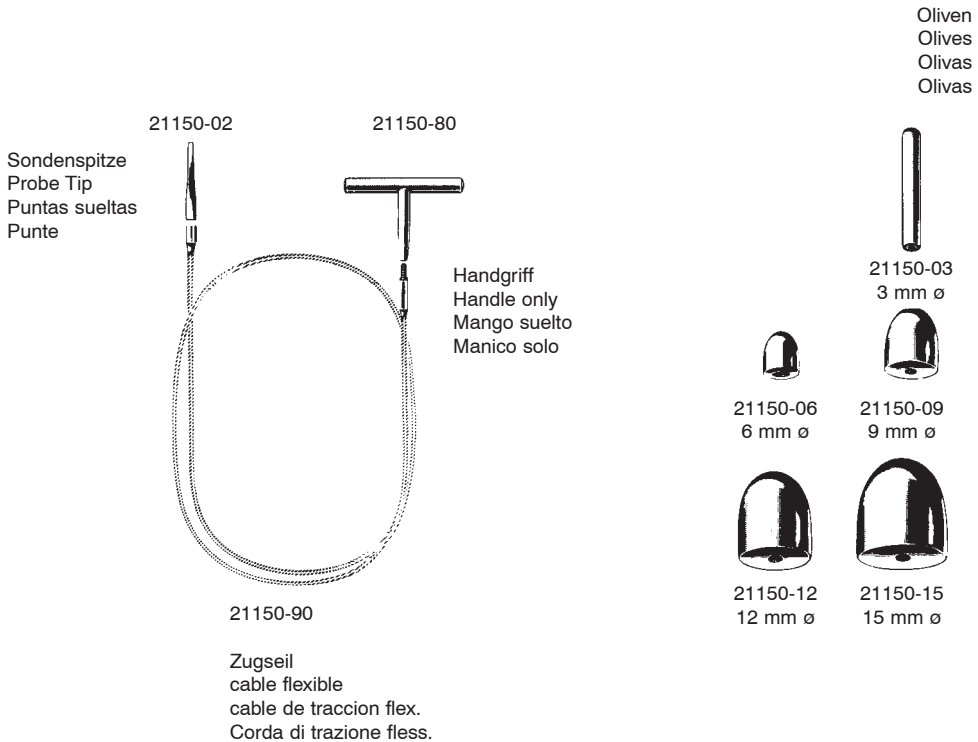

Varizeninstrumente  
 Varix Instruments  
 Instrumentos para varices  
 Strumenti per varici



VARADY  
 21154-01  
 180 mm, 7"



VARADY  
 21154-02  
 180 mm, 7"



VARADY  
 21154-03  
 180 mm, 7"



VARADY  
 21154-04  
 175 mm, 6.9"



VARADY  
 21154-05  
 170 mm, 6 3/4"



VARADY  
 21154-06  
 170 mm, 6 3/4"

21162-12  
 12 cm, 4 3/4"  
 Griff  
 Handle  
 Mango  
 Manico

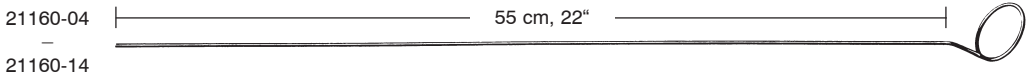

21160-04  
 4 mm ø



21160-06  
 6 mm ø



21160-07  
 7 mm ø



21160-08  
 8 mm ø



21160-10  
 10 mm ø

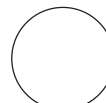

21160-12  
 12 mm ø

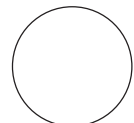

21160-14  
 14 mm ø

Watteträger, Spatel  
 Cotton Applicators, Spatulas  
 Porta-algodones, Espátulas  
 Portacotone, Spatole



FARRELL

4 3/4"	21270-12	12,0 cm
5 1/2"	21270-14	14,0 cm
6 1/2"	21270-16	16,5 cm
7"	21270-18	18,0 cm
9"	21270-23	23,0 cm



FARRELL

4 3/4"	21272-12	12,0 cm
5 1/2"	21272-14	14,0 cm
6 1/2"	21272-16	16,5 cm
7"	21272-18	18,0 cm
9"	21272-23	23,0 cm



REDA

4 3/4"	21290-12	12,0 cm
5 1/2"	21290-14	14,0 cm
6 1/4"	21290-16	16,0 cm
7"	21290-18	18,0 cm



1,5



1,5

REDA

4 3/4"	21292-12	12,0 cm
5 1/2"	21292-14	14,0 cm
6 1/2"	21292-16	16,0 cm
7"	21292-18	18,0 cm

Spatel  
 Plaster spatula  
 Espátula  
 Spatole

 21190-14  
 14,5 cm, 5 3/4"

 UCKERMANN  
 21310-15  
 15 cm, 6"

ø 3 mm

 JOBSON-HORNE  
 21320-12 12 cm, 4 3/4"  
 21320-18 18 cm, 7"

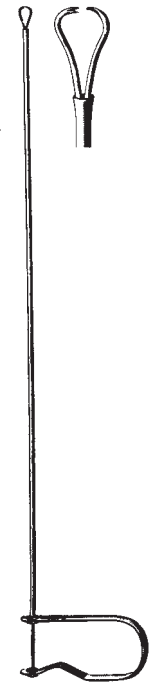
 TOBOLD  
 21331-25  
 25 cm, 10"

 21340-45  
 45 cm, 17 3/4"

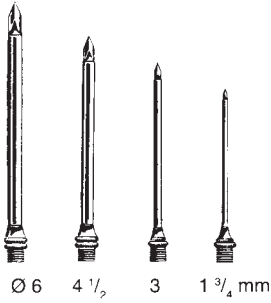
Trokare  
Trocars  
Trócares  
Trequarti



UNIVERSAL  
23104-00  
compl.



STANDARD (NELSON)

23110-30	3,0 mm ø
23110-35	3,5 mm ø
23110-40	4,0 mm ø
23110-45	4,5 mm ø
23110-50	5,0 mm ø
23110-55	5,5 mm ø
23110-60	6,0 mm ø



PIERCE

23123-30	3,0 mm Ø
23123-40	4,0 mm Ø
23123-50	5,0 mm Ø



DOUGLAS  
23125-11    3 mm Ø

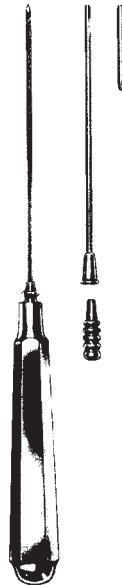

LICHTWITZ  
23128-19    1,75 mm Ø

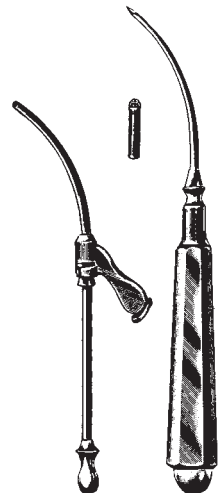

COAKLEY  
23140-02    2,25 mm Ø

Trokare  
Trocars  
Trócares  
Trequarti

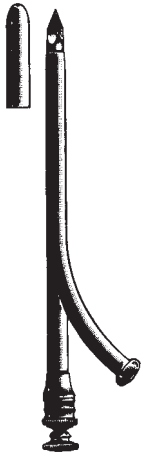

Charr./	F.G.	OCHSNER
10	23150-10	
12	23150-12	
14	23150-14	
16	23150-16	
18	23150-18	
20	23150-20	



Charr./	F.G.	NELSON	ø
25	23170-25		7,5 mm
30	23170-30		9,0 mm
33	23170-33		10,5 mm
35	23170-35		12,0 mm



SINOSKOPIE-TROKAR  
8,5 cm, 3.4"

23181-40 f. Optik mit Ø 4,0 mm

Biopsiekanülen  
Biopsy Needles  
Agujas para biopsia  
Aghi per biopsia

Nadelführer  
Pudendus  
Anesthésie  
anestesia



IOWA  
23210-00  
14 cm, 5 1/2"  
compl.

Pneumoperitoneum  
Pneumoperitoneum  
Neumoperitoneo  
Pneumoperitoneo



VERRES  
23250-20 2,00x100 mm  
23250-40 2,00x140 mm



MENGHINI  
23302-01 1,0x 35 mm  
23302-02 1,0x 70 mm  
23302-03 1,2x 70 mm  
23302-04 1,2x100 mm  
23302-05 1,4x 70 mm  
23302-06 1,4x100 mm  
23302-07 1,6x 70 mm  
23302-08 1,8x100 mm



MENGHINI  
23310-14 1,4x168 mm  
23310-18 1,8x168 mm



Führungsnadeln  
 Guide needles  
 Aguja de Guía  
 Ago guida

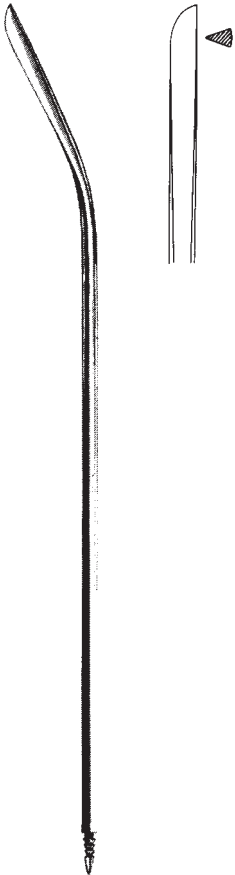

REDON  
 23195-08 - 23195-18

Messerspitze, gerade  
 Guide Needle, straight  
 Aguja de guía, recta  
 Ago guida, retta

Charr./Fr.  
 8 23195-08  
 10 23195-10  
 12 23195-12  
 14 23195-14  
 16 23195-16  
 18 23195-18



REDON  
 23197-08 - 23197-18

Messerspitze, gebogen  
 Guide Needle, curved  
 Aguja de guía, curva  
 Ago guida, curva

Charr./Fr.  
 8 23197-08  
 10 23197-10  
 12 23197-12  
 14 23197-14  
 16 23197-16  
 18 23197-18

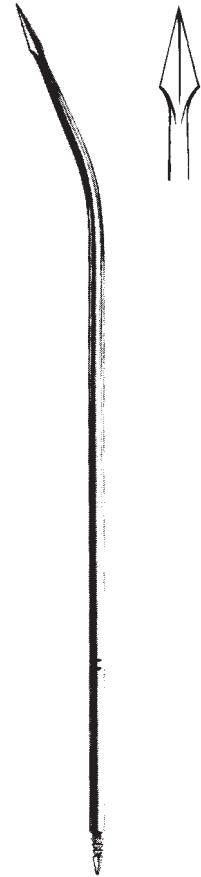

REDON  
 23198-08 - 23198-18

Lanzettspitze, gerade  
 Lancet tip, straight  
 Punta lanceolar, recta  
 Punta lanceolata, retta

Charr./Fr.  
 8 23198-08  
 10 23198-10  
 12 23198-12  
 14 23198-14  
 16 23198-16  
 18 23198-18

Nadelhalter  
Needle Holders  
Porta-agujas  
Port'aghi



DERF

25110-12 12 cm, 4 <sup>3</sup>/<sub>4</sub>"  
25114-12 TC 12 cm, 4 <sup>3</sup>/<sub>4</sub>"



DERF

25120-12 12,5 cm, 5"

COLLIER

25122-12 12,5 cm, 5"



glatt  
smooth  
lisa  
liscia

WEBSTER

25128-13 13 cm, 5 <sup>1</sup>/<sub>8</sub>"  
25129-13 TC 13 cm, 5 <sup>1</sup>/<sub>8</sub>"

BABY-WEBSTER

25136-11 11 cm, 4 <sup>3</sup>/<sub>8</sub>"  
25137-11 TC 11 cm, 4 <sup>3</sup>/<sub>8</sub>"

25138-11 TC 11 cm, 4 <sup>3</sup>/<sub>8</sub>"  
gerieft/serrated  
estriada/zigrinato



HALSEY

25130-13 25140-13  
25134-13 TC 25144-13 TC  
13 cm, 5 <sup>1</sup>/<sub>8</sub>"



NEIVERT

25146-13 25148-13 TC  
13 cm, 5 <sup>1</sup>/<sub>8</sub>"



BAUMGARTNER

25150-12 25154-12 TC  
12,5 cm, 5"  
25150-14 25154-14 TC  
14,0 cm, 5 <sup>1</sup>/<sub>2</sub>"

Nadelhalter  
Needle Holders  
Porta-agujas  
Port'aghi



CRILE-WOOD

- |          |           |             |
|----------|-----------|-------------|
| 25160-15 | 15 cm, 6" | 25164-15 TC |
| 25160-18 | 18 cm, 7" | 25164-18 TC |
| 25160-20 | 20 cm, 8" | 25164-20 TC |
| 25160-23 | 23 cm, 9" | 25164-23 TC |



CRILE-MURRAY

- |          |             |
|----------|-------------|
| 25170-15 | 25174-15 TC |
|          | 15 cm, 6"   |



MAYO-HEGAR

- |          |                |             |
|----------|----------------|-------------|
| 25180-12 | 12 cm, 4 3/4"  | 25184-12 TC |
| 25180-14 | 14 cm, 5 1/2"  | 25184-14 TC |
| 25180-16 | 16 cm, 6 1/4"  | 25184-16 TC |
| 25180-18 | 18 cm, 7"      | 25184-18 TC |
| 25180-20 | 20 cm, 8"      | 25184-20 TC |
| 25180-24 | 24 cm, 9 1/2"  | 25184-24 TC |
| 25180-26 | 26 cm, 10 1/4" | 25184-26 TC |
| 25180-30 | 30 cm, 11 3/4" | 25184-30 TC |



fein  
fine  
delicate  
fino

MAYO-HEGAR

- |          |               |             |
|----------|---------------|-------------|
| 25190-16 | 16 cm, 6 1/4" | 25194-16 TC |
| 25190-18 | 18 cm, 7"     | 25194-18 TC |
| 25190-20 | 20 cm, 8"     | 25194-20 TC |



BROWN

- |          |               |
|----------|---------------|
| 25196-13 | 13 cm, 5 1/8" |
| 25196-18 | 18 cm, 7"     |

Nadelhalter  
Needle Holders  
Porta-agujas  
Port'aghi



DE BAKAY

25214-16 TC	16 cm, 6 1/4"
25214-18 TC	18 cm, 7"
25214-20 TC	20 cm, 8"
25214-23 TC	23 cm, 9"
25214-26 TC	26 cm, 10 1/4"
25214-31 TC	31 cm, 12 1/4"



RYDER 1 mm

25224-13 TC	13 cm, 5 1/8"
25224-15 TC	15 cm, 6"
25224-18 TC	18 cm, 7"
25224-20 TC	20 cm, 8"
25224-23 TC	23 cm, 9"
25224-26 TC	26 cm, 10 1/4"

RYDER 2 mm

25225-13 TC	
25225-15 TC	
25225-18 TC	
25225-20 TC	
25225-23 TC	
25225-26 TC	

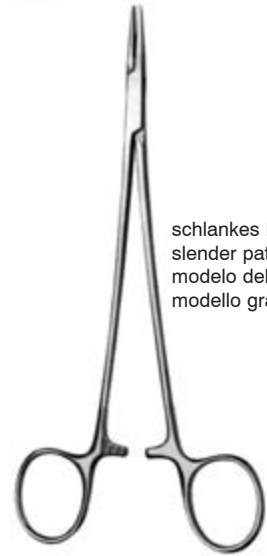

schlankes Modell  
slender pattern  
modelo delgado  
modello gracile

MICROVASCULAR

25230-18 TC	18 cm, 7"
25230-20 TC	20 cm, 8"
25230-23 TC	23 cm, 9"



HEANEY

25241-21	21 cm, 8 1/4"
25241-26	26 cm, 10 1/4"
25245-21 TC	21 cm, 8 1/4"
25245-26 TC	26 cm, 10 1/4"

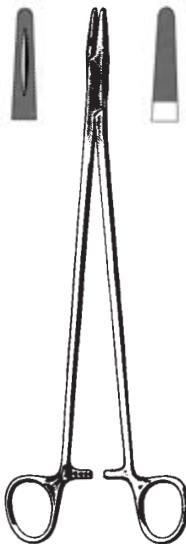

MASSON

25250-27	27 cm, 10 1/2"
25254-27 TC	27 cm, 10 1/2"



WANGENSTEEN

25260-27	27 cm, 10 1/2"
25264-27 TC	27 cm, 10 1/2"

Nadelhalter  
Needle Holders  
Porta-agujas  
Port'aghi

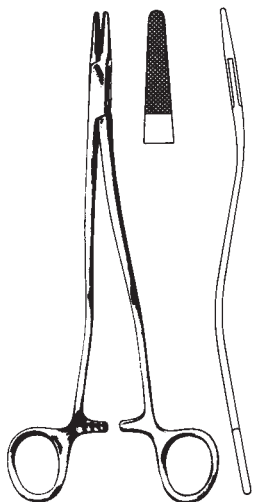

BOZEMANN

- 25285-20 TC 20 cm, 8"
- 25285-24 TC 24 cm, 9 1/2"
- 25285-26 TC 26 cm, 10 1/4"

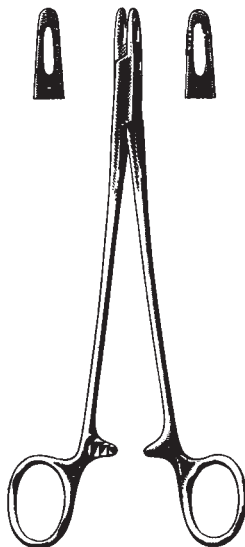

METZENBAUM

- 25290-18  
18 cm, 7"

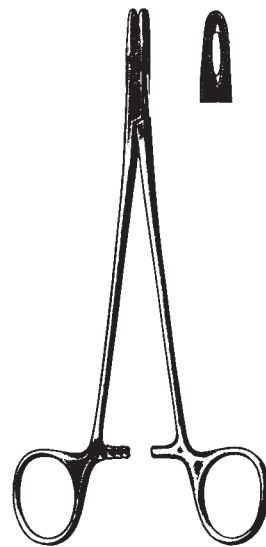

ADSON

- 25292-18  
18 cm, 7"

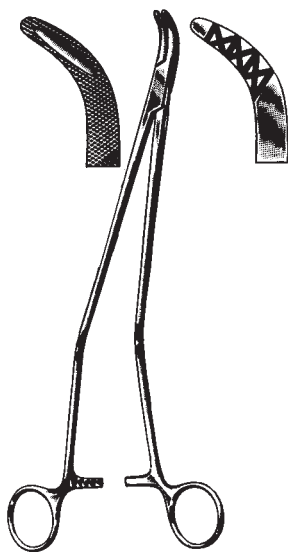

JOHNSON

- 25293-27  
27 cm, 10 1/2"

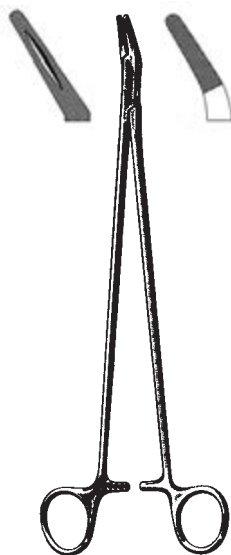

FINOCHIETTO

- 25311-20 20 cm, 8"    25315-20 TC
- 25311-27 27 cm, 10 1/2"    25315-27 TC



SAROT

- 25324-18 TC 18 cm, 7"
- 25324-26 TC 26 cm, 10 1/4"

Nadelhalter  
Needle Holders  
Porta-agujas  
Port'aghi

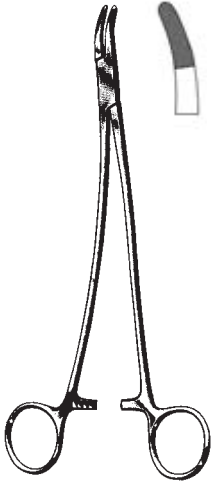

STRATTE

25330-21 21 cm, 8 1/4"  
25330-23 23 cm, 9" **25334-23 TC**

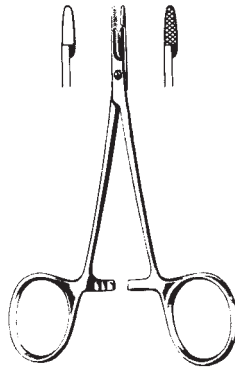

BABY-OLSEN-HEGAR

25405-12 25406-12  
**25408-12 TC 25407-12 TC**  
11,5 cm, 4 1/2"

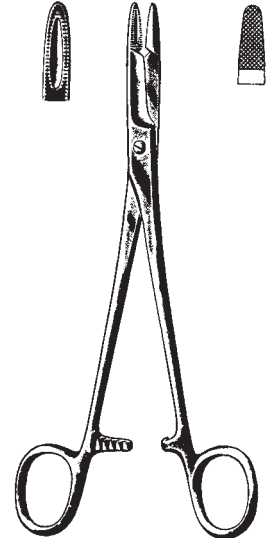

OLSEN-HEGAR

25410-14 14 cm, 5 1/2" **25414-14 TC**  
25410-17 17 cm, 6 3/4" **25414-17 TC**  
18 cm, 7" **25414-18 TC**



MATHIEU-OLSEN

**25415-14 TC** 14 cm, 5 1/2"  
**25415-17 TC** 17 cm, 6 3/4"  
**25415-20 TC** 20 cm, 8"

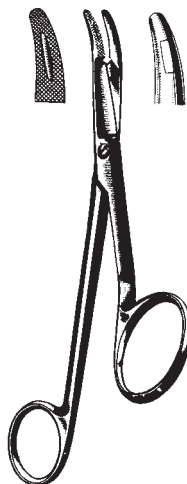

GILLIES

11 cm, 4 3/8" **25434-11 TC**  
13 cm, 5 1/8" **25434-13 TC**  
25430-16 16 cm, 6 1/4" **25434-16 TC**



KILNER

25436-13 13 cm, 5 1/8"  
**25438-13 TC** 13 cm, 5 1/8"

Nadelhalter  
Needle Holders  
Porta-agujas  
Port'aghi

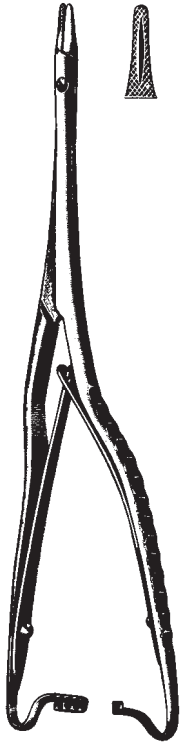

HOESEL

25446-25 25 cm, 10"  
25447-25 TC 25 cm, 10"

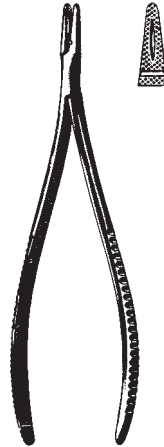

CRILE

25438-15 15 cm, 6"

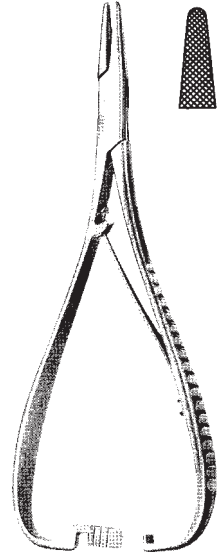

MATHIEU

25450-14 14 cm, 5 1/2" 25452-14 TC  
25450-17 17 cm, 6 3/4" 25452-17 TC  
25450-20 20 cm, 8" 25452-20 TC  
25450-24 24 cm, 9 1/2" 25452-24 TC

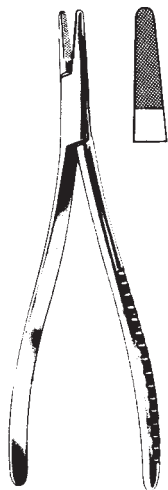

LANGENBECK

25460-18 TC 18 cm, 7"  
25460-20 TC 20 cm, 8"  
25460-23 TC 23 cm, 9"

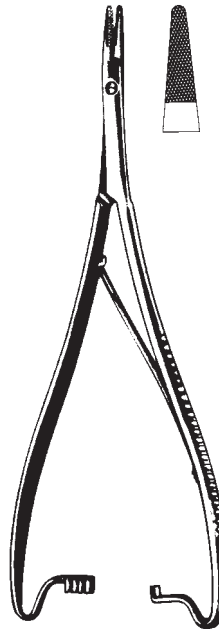

HOESEL

25465-20 TC 20 cm, 8"  
25465-25 TC 25 cm, 10"



LICHTENBERG

25466-17 17 cm, 6 3/4" 25467-17 TC  
25466-20 20 cm, 8" 25467-20 TC

Nadelhalter  
Needle Holders  
Porta-agujas  
Port'aghi

Oftalmologie  
Ophthalmology  
Oftalmologia  
Oftalmologia



STEVENS  
25610-11  
11 cm, 4 3/8"



STEVENS  
25612-13 13 cm, 5 1/8"  
25612-15 15 cm, 6"



BOYNTON  
25614-12  
12 cm, 4 3/4"



BOYNTON  
**25615-12 TC**  
12 cm, 4 3/4"



ARRUGA  
25620-16 - 25624-16  
16 cm, 6 1/4"

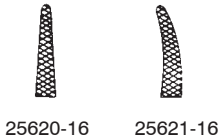

25620-16 25621-16

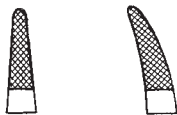

**25624-16 TC 25625-16 TC**



KALT-ARRUGA  
25627-14  
14 cm, 5 1/2"



KALT  
25628-14  
14 cm, 5 1/2"



Nadelhalter  
Needle Holders  
Porta-agujas  
Port'aghi



JACOBSEN  
25667-18 18 cm, 7"  
**25668-18 TC** 18 cm, 7"  
25667-21 21 cm, 8 1/4"  
**25668-21 TC** 21 cm, 8 1/4"



CASTROVIEJO  
14 cm, 5 1/2"



25670-14  
glatt  
smooth  
lisa  
liscia



25672-14  
gerieft  
serrated  
estriada  
zigrinato



**25676-14 TC**



25671-14  
glatt  
smooth  
lisa  
liscia



25673-14  
gerieft  
serrated  
estriada  
zigrinato



**25677-14 TC**

25678-09



CASTROVIEJO-MICRO  
9 cm, 3 1/2"

25679-09



CASTROVIEJO  
25680-13 13 cm, 5 1/8"  
**25684-13 TC** 13 cm, 5 1/8"

Mikro-Nadelhalter  
 Micro-Needle Holders  
 Micro-Porta-agujas  
 Micro-Port'aghi



CASTROVIEJO-STANDARD  
 25678-14 14 cm, 5 1/2"



CASTROVIEJO-STANDARD  
 25679-14 14 cm, 5 1/2"

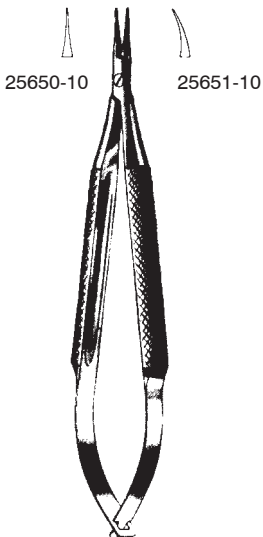

BARRAQUER  
 10 cm, 4"



BARRAQUER-TROUTMAN  
 10 cm, 4"

Mikro-Nadelhalter  
Micro-Needle Holders  
Micro-Porta-agujas  
Micro-Port'aghi



BARRAQUER  
13 cm, 5 1/8"

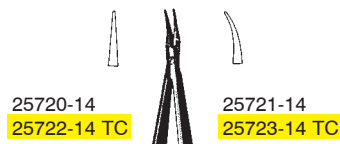

BARRAQUER  
14 cm, 5 1/2"



BARRAQUER  
18 cm, 7"

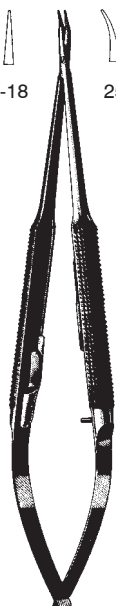
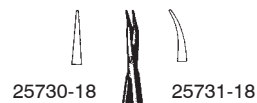

BARRAQUER  
18 cm, 7"

Unterbindungsnadeln  
Ligature Needles  
Agujas para ligaduras  
Aghi per legature



biegsam  
malleable  
maleable  
malleabile

27109-20  
20 cm, 8"

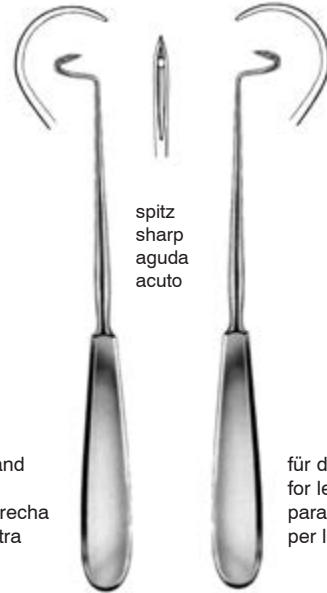

spitz  
sharp  
aguda  
acuto

für die rechte Hand  
for right hand  
para la mano derecha  
per la mano destra

für die linke Hand  
for left hand  
para la mano izquierda  
per la mano sinistra

DESCHAMPS  
27110-21 21 cm, 8 1/4" 27111-21  
27110-24 24 cm, 9 1/2" 27111-24  
27110-27 27 cm, 10 1/2" 27111-27

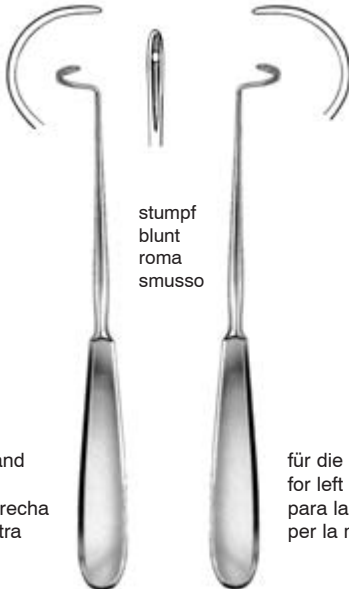

stumpf  
blunt  
roma  
smusso

für die rechte Hand  
for right hand  
para la mano derecha  
per la mano destra

für die linke Hand  
for left hand  
para la mano izquierda  
per la mano sinistra

DESCHAMPS  
27120-21 21 cm, 8 1/4" 27121-21  
27120-24 24 cm, 9 1/2" 27121-24  
27120-27 27 cm, 10 1/2" 27121-27

Unterbindungsnadeln  
Ligature Needles  
Agujas para ligaduras  
Aghi per legature



27130-13  
fein, für die rechte Hand  
delicate, for right hand  
fina, para la mano derecha  
fino, per la mano destra

stumpf  
blunt  
roma  
smusso

27131-13  
fein, für die linke Hand  
delicate, for left hand  
fina, para la mano izquierda  
fino, per la mano sinistra

KRONECKER  
13 cm, 5 1/8"



SCHMIEDEN-DICK  
27134-32 32 cm, 12 3/4"  
biegsam - malleable - maleable - malleabile



stumpf  
blunt  
roma  
smusso

27133-24  
für die rechte Hand  
for right hand  
para la mano derecha  
per la mano destra



NELSON  
24,5 cm, 9 3/4"

27135-24  
für die linke Hand  
for left hand  
para la mano izquierda  
per la mano sinistra



COOPER  
27139-19 19 cm, 7 1/2"

Nahtinstrumente  
Suturing Instruments  
Instrumentos para suturas  
Strumenti per suture

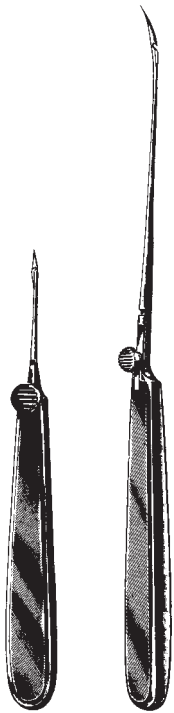

REVERDIN  
27201-15 - 27204-21



Fig. 1

27201-15 15 cm, 6"  
27201-19 19 cm, 7 1/2"  
27201-21 21 cm, 8 1/4"



Fig. 2

27202-15 15 cm, 6"  
27202-19 19 cm, 7 1/2"  
27202-21 21 cm, 8 1/4"



Fig. 3

27203-15 15 cm, 6"  
27203-19 19 cm, 7 1/2"  
27203-21 21 cm, 8 1/4"



Fig. 4

27204-15 15 cm, 6"  
27204-19 19 cm, 7 1/2"  
27204-21 21 cm, 8 1/4"



YOUNG BOOMERANG  
27240-00  
25 cm, 10"



Fig. 1  
27240-01



Fig. 2  
27240-02

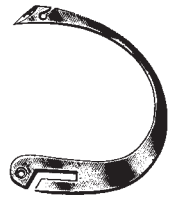
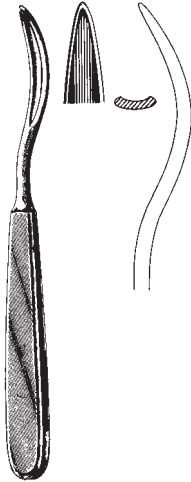
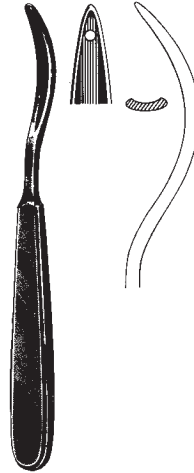

Fig. 3  
27240-03

Führungshohlsonden  
Ligature Conductors  
Sondas conductoras  
Sonde conduttrici



SCHMIEDEN  
27271-19 19 cm, 7 1/2"



SCHMIEDEN-PAYR  
27273-19 19 cm, 7 1/2"

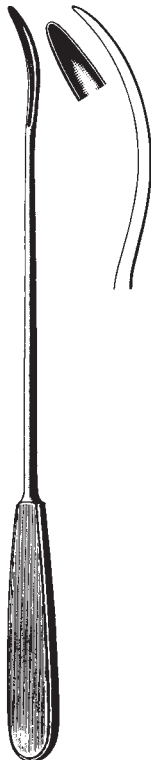

BRUNNER  
27275-30 30 cm, 11 3/4"

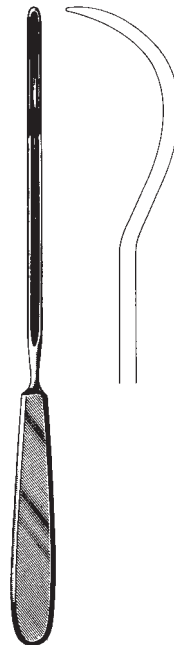

KIRSCHNER  
27277-25 25,5 cm, 10"

Führungshohlsonden, Fadenfänger, Fadengabel  
 Ligature Conductors, Ligature Catcher, Ligature Adjuster  
 Sondas conductoras, Captador de hilos, Horquilla de hilos  
 Sonde conduttrici, Portalegature, Forchetta da sutura

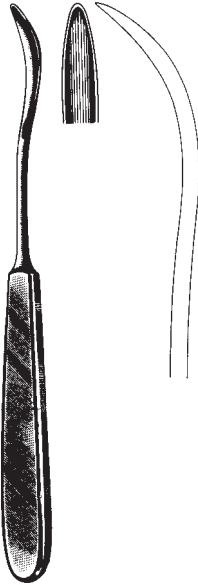

KOENIG  
 27285-20  
 20 cm, 8"



PAYR  
 27288-22  
 22 cm, 8 3/4"



PAYR  
 27289-22  
 22 cm, 8 3/4"

Plastik  
 plastic  
 plástico



BRUNNER  
 27291-18 18 cm, 7"  
 27291-27 27 cm, 10 1/2"



VIENNA  
 27297-23  
 23,5 cm, 9 1/4"



REDA  
 27298-23  
 23 cm, 9"





Chirurgische Nadeln  
Suturing Needles  
Agujas para suturas  
Aghi per suture

Pack à 1 Dutzend  
in packages of 1 dozen  
en sobres de 1 docena  
confezione 1 dozzina

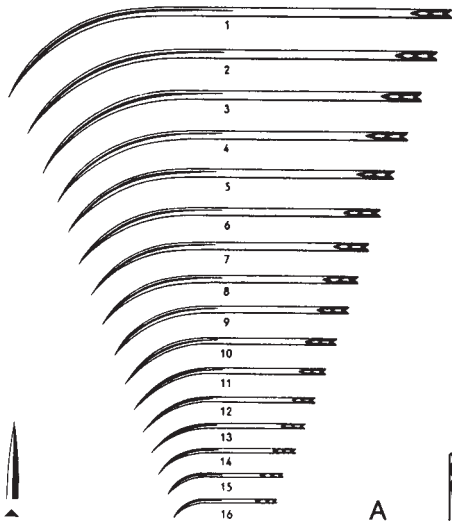

27403-01 - 27403-16

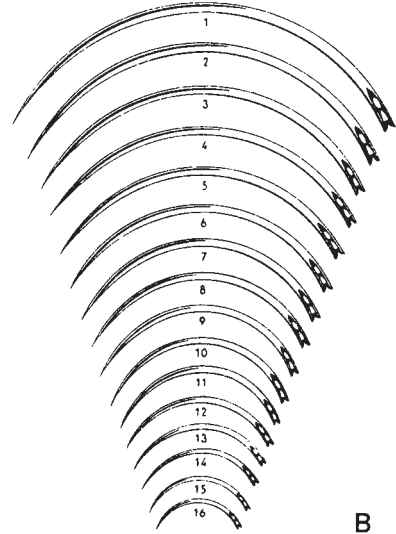

27413-01 - 27413-16

Fig. 1 2 3 4 5 6 7 8 9 10 11 12 13 14 15 16

- A 27403-01 27403-02 27403-03 27403-04 27403-05 27403-06 27403-07 27403-08 27403-09 27403-10 27403-11 27403-12 27403-13 27403-14 27403-15 27403-16
- B 27413-01 27413-02 27413-03 27413-04 27413-05 27413-06 27413-07 27413-08 27413-09 27413-10 27413-11 27413-12 27413-13 27413-14 27413-15 27413-16
- G 27423-01 27423-02 27423-03 27423-04 27423-05 27423-06 27423-07 27423-08 27423-09 27423-10 27423-11 27423-12 27423-13 27423-14 27423-15 27423-16
- Ga 27433-01 27433-02 27433-03 27433-04 27433-05 27433-06 27433-07 27433-08 27433-09 27433-10 27433-11
- Gr 27434-01 27434-02 27434-03 27434-04 27434-05 27434-06 27434-07 27434-08 27434-09 27434-10 27434-11 27434-12 27434-13 27434-14 27434-15 27434-16

Alle Nadeln mit Öhr  
all the needles with spring eye  
todas las agujas con ojo a resorte  
tutti gli aghi con cruna aperta

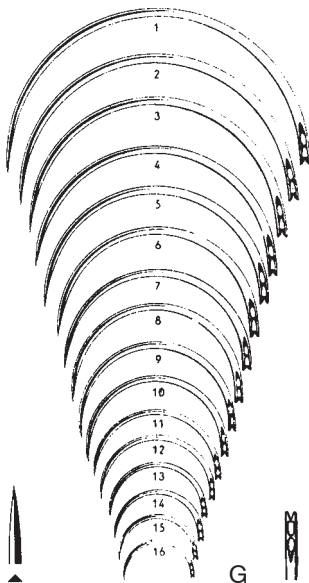

27423-01 - 27423-16

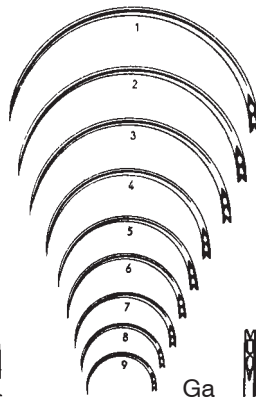

27433-01 - 27433-09

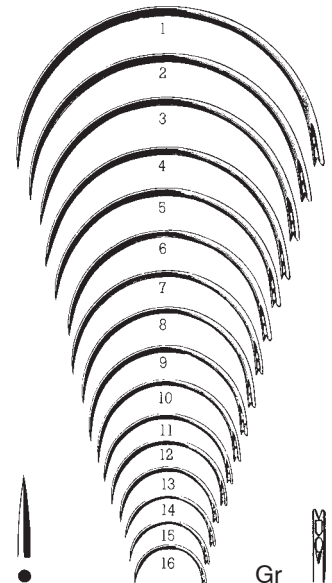

27434-01 - 27434-16

Alle Nadeln mit Öhr  
 all the needles with spring eye  
 todas las agujas con ojo a resorte  
 tutti gli aghi con cruna aperta

Chirurgische Nadeln  
 SUTURING NEEDLES  
 Agujas para suturas  
 Aghi per suture

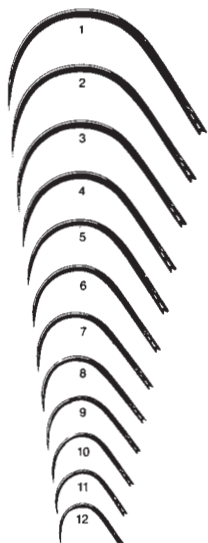

27441-01 - 27441-12

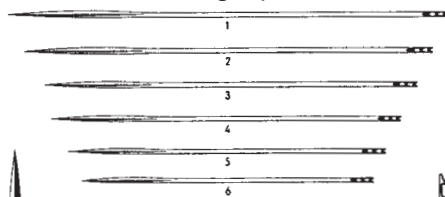

KEITH  
 27450-01 - 27450-06

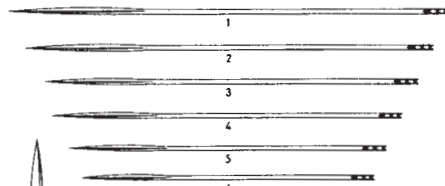

KEITH  
 27452-01 - 27452-06

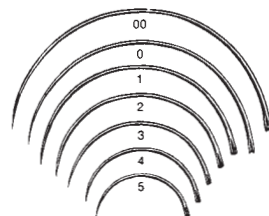

27465-20 - 27467-05 Pb

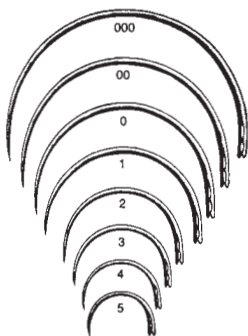

27443-30 - 27443-05

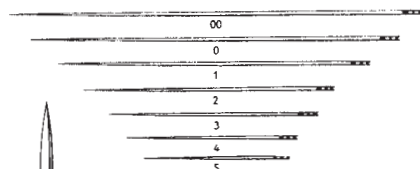

27475-20 - 27477-05 Pc

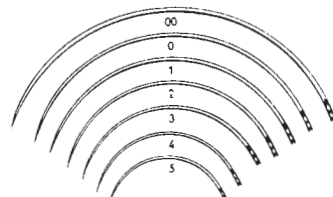

27485-20 - 27487-05 Pd

FIG.	000	00	0	1	2	3	4	5	6	7	8	9	10	11	12
KÖNIG				27441-01	27441-02	27441-03	27441-04	27441-05	27441-06	27441-07	27441-08	27441-09	27441-10	27441-11	27441-12
E	27443-30	27443-20	27443-10	27443-01	27443-02	27443-03	27443-04	27443-05							
KEITH				27450-01	27450-02	27450-03	27450-04	27450-05	27450-06						
KEITH				27452-01	27452-02	27452-03	27452-04	27452-05	27452-06						
Pb	27465-20	27465-10	27467-01	27467-02	27467-03	27467-04	27467-05								
Pc	27475-20	27475-10	27477-01	27477-02	27477-03	27477-04	27477-05								
Pd	27485-20	27485-10	27487-01	27487-02	27487-03	27487-04	27487-05								

Wundklammerpinzetten und -zangchen, Wundklammern  
 Clip Applying Forceps, Suture Clips  
 Pinzas aplicadoras para agrafes, Agrafes de sutura  
 Pinze per applicare le agrafe, Agrafe



MICHEL  
 27610-12  
 12 cm, 4 3/4"



WACHENFELDT  
 27612-12  
 12,5 cm, 5"



WACHENFELDT  
 27614-12  
 12,5 cm, 5"



HEGENBARTH  
 27616-12  
 12,5 cm, 5"



CHILDE  
 27620-18  
 18 cm, 7"



MICHEL  
 27630-12  
 12 cm, 4 3/4"



COLLIN  
 27640-13  
 13 cm, 5 1/8"



RICHTER-HEATH  
 27642-14  
 14 cm, 5 1/2"

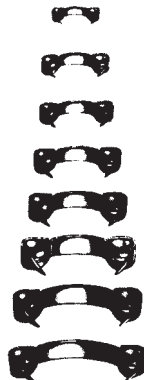

MICHEL

- MICHEL mm
- 27660-07 7,5x1,75
- 27660-11 11x2
- 27660-12 12x2,5
- 27660-14 14x3
- 27660-16 16x3
- 27660-18 18x3
- 27660-20 20x3
- 27660-22 22x3

Pack  1000  
 box of 1000  
 paq x 1000  
 confezione x 1000



Nahtbesteck  
Suture Set  
Estuche para suturas  
Set per sutura



STANDARD

27680-00  
165 x 90 x 28 mm

Komplett in Metalletui und Plastiktasche mit 2 herausnehmbaren gelochten Einlagen mit Stegen für Instrumente

Bestehend aus:

- 1 Mathieu Nadelhalter 14 cm (5 $\frac{1}{2}$ " )
- 1 Nähseide in Alkohol
- 6 Nähnadeln sortiert
- 1 Nadeldose gelocht 65 x 42 cm
- 1 Michel Wundklammerzange
- 20 Wundklammern auf Halter
- 1 Skalpellgriff mit Klinge
- 3 Klängen auswechselbar
- 1 Schere st/sp. 13 cm (5") gerade
- 1 anat. Pinzette 11,5 cm (4 $\frac{1}{2}$ " )
- 1 Hakenpinzette 1 x 2 Z. 12 cm (4 $\frac{3}{4}$ " )
- 1 Hunter Splitterpinzette 10,5 cm (4 $\frac{1}{4}$ " )
- 1 Kocher Arterienklemme 13 cm (5")
- 1 Myrtenblattsonde 13 cm (5")

Complete in metal case with plastic pouch and 2 removable perforated trays for instruments

Contents:

- 1 Mathieu Needle Holder, 14 cm (5 $\frac{1}{2}$ " )
- 1 Flacon with sterilized silk in alcohol
- 6 Suture Needles, assorted
- 1 Needle Case, 25.6" x 16.5", perforated
- 1 Michel Suture Clip Forceps
- 20 Michel Suture Clips with Clip Holder
- 1 Scalpel Handle with Blade
- 3 Scalpel Blades, interchangeable
- 1 Scissors, straight, blunt/sharp, 13 cm (5")
- 1 Dressing Forceps, 11,5 cm (4 $\frac{1}{2}$ " )
- 1 Tissue Forceps, 12 cm (4 $\frac{3}{4}$ " ), 1 x 2 teeth
- 1 Hunter Splinter Forceps, 10,5 cm (4 $\frac{1}{4}$ " )
- 1 Kocher Artery Forceps, straight, 13 cm (5"), S
- 1 Probe with myrtle leaf, 13 cm (5")

Completo en caja de metal con bolsa de plástico y 2 bandejas perforadas para los instrumentos

Contenido:

- 1 Porta-aguja de Mathieu, 14 cm (5 $\frac{1}{2}$ " )
- 1 Frasco con seda esterilizada para sutura, en alcohol
- 6 Agujas de sutura surtidas
- 1 Cajita para agujas, 65 x 42 mm, perforada
- 1 Pinza para agrafes de Michel
- 20 Agrafes de Michel, en su porta-agrafes
- 1 Mango de bisturi, con hoja intercambiable
- 3 Hojas intercambiables surtidas
- 1 Tijera, recta, roma/aguda, 13 cm (5")
- 1 Pinza de disección, 11,5 cm (4 $\frac{1}{2}$ " )
- 1 Pinza de disección, con 1 x 2 dientes, 12 cm (4 $\frac{3}{4}$ " )
- 1 Pinza para espinas de Hunter, 10,5 cm (4 $\frac{1}{4}$ " )
- 1 Pinza hemostática de Kocher, 13 cm (5"), S.
- 1 Estilete abotonado, multiforme, 13 cm (5")

Astuccio tascabile con due supporti estraibili

Contenente:

- 1 Port aghi di Mathieu 14 cm (5 $\frac{1}{2}$ " )
- 1 Set per sutura in flacone di vetro
- 6 aghi per sutura assortiti
- 1 scatola per aghi 65 x 24 perforata
- 1 pinza per sutura di Michel
- 20 Agrafe Michel ed porta agrafe
- 1 Manico da bisturi per lama intercambiabile
- 3 lame da bisturi intercambiabili
- 1 forbici rette alterne 13 cm (5")
- 1 pinze da dissezione
- 1 pinze da dissezione 1 x 2 denti
- 1 pinze di Hunter per schegge 10,5 cm (4 $\frac{1}{4}$ " )
- 1 pinze emostatiche di Kocher 13 cm (5")
- 1 specillo bottonuto 13 cm (5")

Sterilisierzangen, Abfallzange, Sterilisierklammern  
 Sterilization Instruments, Waste Forceps, Safety pins  
 Instrumentos para la esterilización, Pinza para desechos, Cadres de estérilizacion,  
 Pinze per la sterilizzazione, Pinza per rifiuti, Spilloni p. sterilizzazione



**DAVIS**  
 29102-16 16 cm, 6 1/4"  
 29102-20 20 cm, 8"  
 29102-24 24 cm, 9 1/2"



**CHEATLE**  
 29110-27  
 27 cm, 10 1/2"



**UNIVERSAL**  
 29120-20 20 cm, 8"    29121-20  
 29120-28 28 cm, 11"    29121-28



**ROGGE**  
 29130-23  
 23 cm, 9"



29140-20 20 cm, 8"  
 29140-30 30 cm, 11 3/4"



**SAUERBRUCH**  
 29145-55  
 55 cm, 21.7"



**BUNT**  
 29150-12 12 cm, 5 3/4"

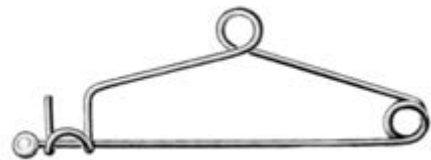

**MAYO**  
 29152-14 14 cm, 5 1/2"





Gipsscheren  
 Plaster of Paris Shears  
 Cizallas para vendajes enyesados  
 Cesioie per gessi

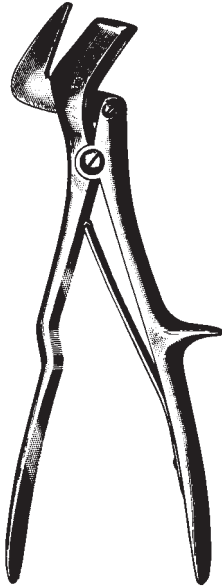

STILLE  
 31101-24 24 cm, 9 1/2"



STILLE  
 31103-23 23 cm, 9"  
 31103-26 26 cm, 10 1/4"  
 31103-37 37 cm, 14 1/2"



Gipsmesser  
 plaster knife  
 cuchillo para vendajes enyesados  
 coltello da gesso

WIGMORE  
 31120-19 19 cm, 7 1/2"

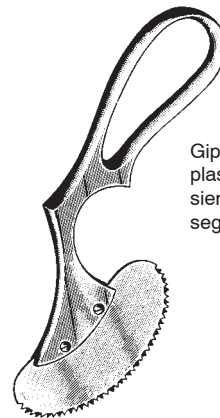

Gipssäge  
 plaster saw  
 sierra para vendajes enyesados  
 sega da gesso

ENGEL  
 31130-14 16 cm, 6 1/4"  
 verchromt, chrome plated

Autopsiesäge  
Autopsy saw  
Sierra para autopsia  
Sega per autopsia

Geräuschpegel: 52 - 77 db (A)  
Noise level: 52 - 77 db (A)  
Nivel de ruido del aparato sólo: 52 - 77 db (A)  
Livello acustico dello strumento solo: 52 - 77 db (A)

6500-24000 Schwingungen pro Minute  
6500-24000 oscillations per minute  
6500-24000 oscilaciones por minuto  
6500-24000 oscillazioni al minute

EN 60601-1, EN 60601-1-2, IEC 60601-1, IEC 60601-1-2



31201-01 120 Volt, 500 Watt, 1,5 kg

31201-02 230 Volt, 500 Watt, 1,5 kg

**31201-01 + 31201-02 inklusive, inclusive, inclusive, inclusive:**

- 1x 31210-50 Ø 50mm Sägeblatt, saw blade, hoja de repuesto, lama per sega
- 1x 31210-65 Ø 65mm Sägeblatt, saw blade, hoja de repuesto, lama per sega
- 1x 31204-01 Ø 50/65mm Segment-Sägeblatt, segment saw blade, hoja de repuesto para segmento, lama per sega a segmento
- 1x 31202-16 Inbusschlüssel T-Griff, alan key with T-handle, llave hexagonal con mango de T, chiave esagonale con manico a T
- 1x 31200-95 Spritze, gefüllt mit Fett, injection filled with fat, jeringa rellena con grasa, siringa colmata con grassa
- 1x 31212-02 Paar Gabelschlüssel, pair flat wrench, pareja llave de boca, paio chiave a bocca, 11mm

Zubehör für Autopsiesäge 31201-02 und 31201-01 siehe Seite 230/14 - 230/18  
Accessories for Autopsy saw 31201-02 and 31201-01 please see page 230/14 - 230/18  
Accesorios para sierra para autopsia 31201-02 y 31201-01 vea la página 230/14 - 230/18  
Accessorio per sega per autopsia 31201-02 e 31201-01 vedi pagina 230/14 - 230/18

31210-45	Ø 45mm	Sägeblatt, saw blade, hoja de repuesto, lama per sega
31210-50	Ø 50mm	Sägeblatt, saw blade, hoja de repuesto, lama per sega
31210-65	Ø 65mm	Sägeblatt, saw blade, hoja de repuesto, lama per sega
31204-01	Ø 50/65mm	Segment-Sägeblatt, segment saw blade, hoja de repuesto para segmento, lama per sega a segmento
31204-03	Ø 65/65mm	Segment-Sägeblatt, segment saw blade, hoja de repuesto para segmento, lama per sega a segmento
31205-08	8mm	Tiefen-Sägeblatt, deep cutting saw, hoja de sierra de profundidad, lama a taglio di profondità
31205-20	20mm	Tiefen-Sägeblatt, deep cutting saw, hoja de sierra de profundidad, lama a taglio di profondità
31203-50		Begrenzungsscheibe, limiting disc, disco de tope, disco eccentrico
31202-16		Inbusschlüssel T-Griff, alan key with T-handle, llave hexagonal con mango de T, chiave esagonale con manico a T
31200-95		Spritze gefüllt mit Fett, injection filled with fat, jeringa rellena con grasa, siringa colmata con grassa
31212-02		1 Paar Gabelschlüssel, pair flat wrench, pareja llave de boca, paio chiave a bocca, 11mm

Autopsiesäge  
Autopsy saw  
Sierra para autopsia  
Sega per autopsia

Geräuschpegel: 52 - 77 db (A)  
Noise level: 52 - 77 db (A)  
Nivel de ruido del aparato sólo: 52 - 77 db (A)  
Livello acustico dello strumento solo: 52 - 77 db (A)

6500-24000 Schwingungen pro Minute  
6500-24000 oscillations per minute  
6500-24000 oscilaciones por minuto  
6500-24000 oscillazioni al minute

EN 60601-1, EN 60601-1-2, IEC 60601-1, IEC 60601-1-2



Dreikantschaft  
Three-jaw chuck  
Mandril de tres mordazas  
Mandrino con tre ganasce



31201-11 120 Volt, 500 Watt, 1,5 kg

31201-22 230 Volt, 500 Watt, 1,5 kg

**31201-11 + 31201-22 inklusive, inclusive, inclusive, inclusive:**

- 31201-39 39mm Schaft komplett, Arbor complete, Vastago completo, Asta completa
- 1x 31210-50 Ø 50mm Sägeblatt, saw blade, hoja de repuesto, lama per sega
- 1x 31210-65 Ø 65mm Sägeblatt, saw blade, hoja de repuesto, lama per sega
- 1x 31204-01 Ø 50/65mm Segment-Sägeblatt, segment saw blade, hoja de repuesto para segmento, lama per sega a segmento
- 1x 31202-16 Inbusschlüssel T-Griff, alan key with T-handle, llave hexagonal con mango de T, chiave esagonale con manico a T
- 1x 31200-95 Spritze gefüllt mit Fett, injection filled with fat, jeringa rellena con grasa, siringa colmata con grassa
- 1x 31202-14 Paar Gabelschlüssel, pair flat wrench, pareja llave de boca, paio chiave a bocca, 14mm

Zubehör für Autopsiesäge 31201-22 und 31201-11 siehe Seite 230/14 - 230/18  
Accessories for Autopsy saw 31201-22 and 31201-11 please see page 230/14 - 230/18  
Accesorios para sierra para autopsia 31201-22 y 31201-11 vea la página 230/14 - 230/18  
Accessorio per sega per autopsia 31201-22 e 31201-11 vedi pagina 230/14 - 230/18

31210-45	Ø 45mm	Sägeblatt, saw blade, hoja de repuesto, lama per sega
31210-50	Ø 50mm	Sägeblatt, saw blade, hoja de repuesto, lama per sega
31210-65	Ø 65mm	Sägeblatt, saw blade, hoja de repuesto, lama per sega
31204-01	Ø 50/65mm	Segment-Sägeblatt, segment saw blade, hoja de repuesto para segmento, lama per sega a segmento
31204-03	Ø 65/65mm	Segment-Sägeblatt, segment saw blade, hoja de repuesto para segmento, lama per sega a segmento
31205-08	8mm	Tiefen-Sägeblatt, deep cutting saw, hoja de sierra de profundidad, lama a taglio di profondità
31205-20	20mm	Tiefen-Sägeblatt, deep cutting saw, hoja de sierra de profundidad, lama a taglio di profondità
31203-50		Begrenzungsscheibe, limiting disc, disco de tope, disco eccentrico
31202-16		Inbusschlüssel T-Griff, alan key with T-handle, llave hexagonal con mango de T, chiave esagonale con manico a T
31200-95		Spritze gefüllt mit Fett, injection filled with fat, jeringa rellena con grasa, siringa colmata con grassa
31202-14		1 Paar Gabelschlüssel, pair flat wrench, pareja llave de boca, paio chiave a bocca, 14mm

Zubehör zur Autopsiesäge  
Accessories for Autopsy saw  
Accesorio para la sierra de autopsia  
Accessori per sega per autopsia

**31201-39, 39 mm**

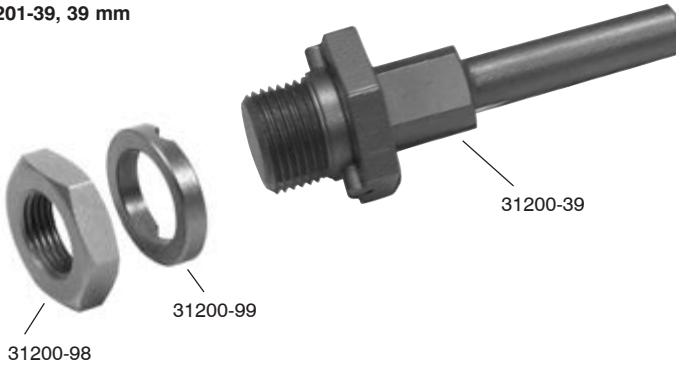

**31201-58, 58 mm**

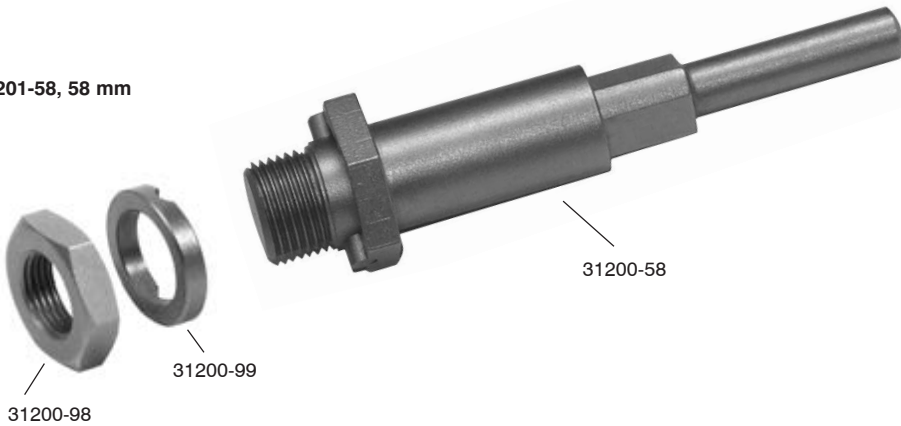

Zubehör zur Autopsiesäge  
Accessories for Autopsy saw  
Accesorio para la sierra de autopsia  
Accessori per sega per autopsia

**Set 31203-10****Set 31203-10:** 31201-39 + 31210-65**Set 31203-00:** 31201-39 + 31210-50**Set 31203-20:** 31201-58 + 31210-50**Set 31203-30:** 31201-58 + 31210-65**Set 31204-00****Set 31204-00:** 31201-39 + 31204-01**Set 31204-10:** 31201-39 + 31204-03**Set 31204-20:** 31201-58 + 31204-01**Set 31204-30:** 31201-58 + 31204-03

Zubehör zur Autopsiesäge  
 Accessories for Autopsy saw  
 Accesorio para la sierra de autopsia  
 Accessori per sega per autopsia

**Set 31205-00**



**Set 31205-00:** 31201-39 + 31205-20

**Set 31206-00:** 31201-39 + 31205-08

**Set 31206-10:** 31201-58 + 31205-08

**Set 31205-10:** 31201-58 + 31205-20

**Set 31210-10**



**Set 31210-10:** 31201-39 + 31210-65 + 31203-50

**Set 31210-00:** 31201-58 + 31210-65 + 31203-50



Zubehör zur Autopsiesäge  
Accessories for Autopsy saw  
Accesorio para la sierra de autopsia  
Accessori per sega per autopsia

**Set 31202-00**

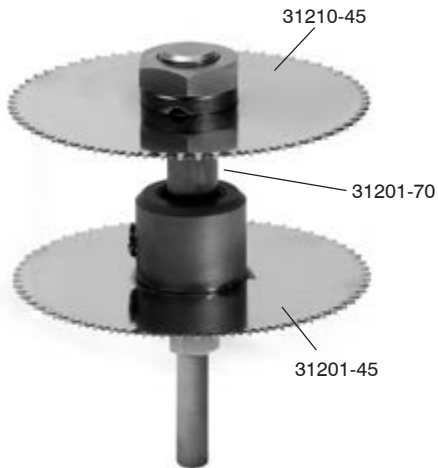

**Set 31202-00:** 31201-70 + 31210-45 + 31201-45

**31201-70**

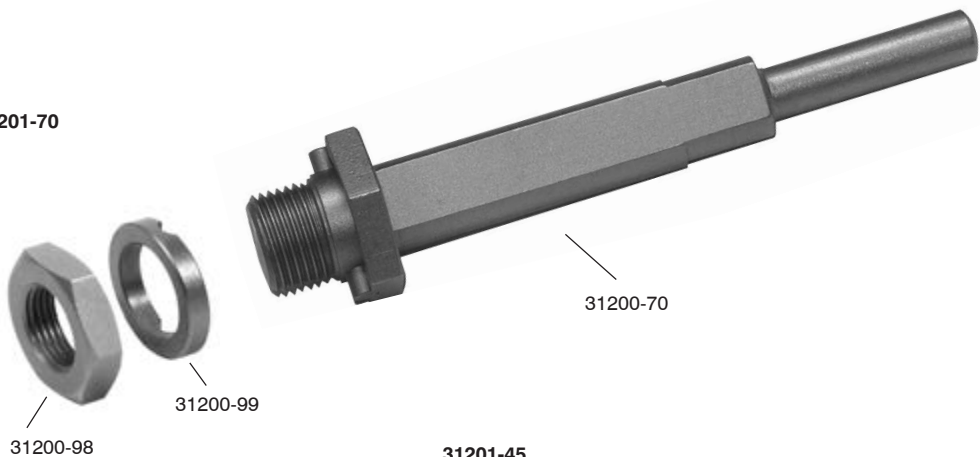

**31201-45**

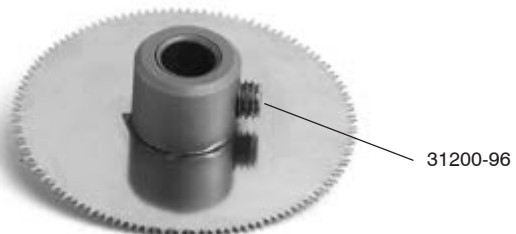

Zubehör für Autopsiesäge 31201-22 und 31201-11 siehe Seite 230/4 - 230/7  
 Accessories for Autopsy saw 31201-22 and 31201-11 please see page 230/4 - 230/7  
 Accesorios para sierra para autopsia 31201-22 y 31201-11 vea la página 230/4 - 230/7  
 Accessorio per sega per autopsia 31201-22 e 31201-11 vedi pagina 230/4 - 230/7

31200-39	Schaft 39mm allein
31201-39	Schaft 39mm komplett
31203-00	Schaft 39mm komplett + Sägeblatt Ø 50mm
31203-10	Schaft 39mm komplett + Sägeblatt Ø 65mm
31204-00	Schaft 39mm komplett + Segmentsägeblatt 50/65mm
31204-10	Schaft 39mm komplett + Segmentsägeblatt 65/65mm
31210-10	Schaft 39mm komplett + Sägeblatt Ø 65mm + Begrenzungsscheibe
31206-00	Schaft 39mm komplett + Tiefensägeblatt 8mm
31205-00	Schaft 39mm komplett + Tiefensägeblatt 20mm
31200-58	Schaft 58mm allein
31201-58	Schaft 58mm komplett
31203-20	Schaft 58mm komplett + Sägeblatt Ø 50mm
31203-30	Schaft 58mm komplett + Sägeblatt Ø 65mm
31204-20	Schaft 58mm komplett + Segmentsägeblatt 50/65mm
31204-30	Schaft 58mm komplett + Segmentsägeblatt 65/65mm
31210-00	Schaft 58mm komplett + Sägeblatt Ø 65mm + Begrenzungsscheibe
31206-10	Schaft 58mm komplett + Tiefensägeblatt 8mm
31205-10	Schaft 58mm komplett + Tiefensägeblatt 20mm
31200-70	Schaft Doppelsäge allein
31201-70	Schaft Doppelsäge komplett
31202-00	Schaft Doppelsäge komplett + Sägeblatt Ø 45mm + verstellbares Sägeblatt Ø 45mm
31201-45	verstellbares Sägeblatt Ø 45mm komplett
31200-96	Inbusmadenschraube für verstellbares Sägeblatt Ø 45mm komplett
31200-98	Mutter für Schaft
31200-99	Sperring für Schaft
31200-39	Arbor 39mm only
31201-39	Arbor 39mm complete
31203-00	Arbor 39mm complete + saw blade Ø 50mm
31203-10	Arbor 39mm complete + saw blade Ø 65mm
31204-00	Arbor 39mm complete + segment saw blade 50/65mm
31204-10	Arbor 39mm complete + segment saw blade 65/65mm
31210-10	Arbor 39mm complete + saw blade Ø 65mm + limiting disc
31206-00	Arbor 39mm complete + deep cutting saw 8mm
31205-00	Arbor 39mm complete + deep cutting saw 20mm
31200-58	Arbor 58mm only
31201-58	Arbor 58mm complete
31203-20	Arbor 58mm complete + saw blade Ø 50mm
31203-30	Arbor 58mm complete + saw blade Ø 65mm
31204-20	Arbor 58mm complete + segment saw blade 50/65mm
31204-30	Arbor 58mm complete + segment saw blade 65/65mm
31210-00	Arbor 58mm complete + saw blade Ø 65mm + limiting disc
31206-10	Arbor 58mm complete + deep cutting saw 8mm
31205-10	Arbor 58mm complete + deep cutting saw 20mm
31200-70	Double saw only
31201-70	Double saw complete
31202-00	Double saw complete + saw blade Ø 45mm + adjustable saw blade Ø 45mm
31201-45	Adjustable saw blade Ø 45mm complete
31200-96	Allen screw for adjustable saw blade Ø 45mm complete
31200-98	Nut for arbor
31200-99	Blocking ring for arbor

Zubehör für Autopsiesäge 31201-22 und 31201-11 siehe Seite 230/4 - 230/7  
Accessories for Autopsy saw 31201-22 and 31201-11 please see page 230/4 - 230/7  
Accesorios para sierra para autopsia 31201-22 y 31201-11 vea la página 230/4 - 230/7  
Accessorio per sega per autopsia 31201-22 e 31201-11 vedi pagina 230/4 - 230/7

31200-39	Vastago 39mm suelto
31201-39	Vastago 39mm completo
31203-00	Vastago 39mm completo + hoja de repuesto Ø 50mm
31203-10	Vastago 39mm completo + hoja de repuesto Ø 65mm
31204-00	Vastago 39mm completo + hoja de repuesto para segmento 50/65mm
31204-10	Vastago 39mm completo + hoja de repuesto para segmento 65/65mm
31210-10	Vastago 39mm completo + hoja de repuesto Ø 65mm + disco de tope
31206-00	Vastago 39mm completo + hoja de sierra de profundidad 8mm
31205-00	Vastago 39mm completo + hoja de sierra de profundidad 20mm
31200-58	Vastago 58mm suelto
31201-58	Vastago 58mm completo
31203-20	Vastago 58mm completo + hoja de repuesto Ø 50mm
31203-30	Vastago 58mm completo + hoja de repuesto Ø 65mm
31204-20	Vastago 58mm completo + hoja de repuesto para segmento 50/65mm
31204-30	Vastago 58mm completo + hoja de repuesto para segmento 65/65mm
31210-00	Vastago 58mm completo + hoja de repuesto Ø 65mm + disco de tope
31206-10	Vastago 58mm completo + hoja de sierra de profundidad 8mm
31205-10	Vastago 58mm completo + hoja de sierra de profundidad 20mm
31200-70	Doble sierra suelta
31201-70	Doble sierra completa
31202-00	Doble sierra completa + hoja de repuesto Ø 45mm + hoja de sierra ajustable Ø 45mm
31201-45	hoja de sierra ajustable Ø 45mm completa
31200-96	tornillo con hembra hexagonal para hoja de sierra ajustable Ø 45mm completa
31200-98	tuerca para vastago
31200-99	anillo de recambio para vastago
31200-39	Asta 39mm sola
31201-39	Asta 39mm completa
31203-00	Asta 39mm completa + lama per sega Ø 50mm
31203-10	Asta 39mm completa + lama per sega Ø 65mm
31204-00	Asta 39mm completa + lama per sega a segmento 50/65mm
31204-10	Asta 39mm completa + lama per sega a segmento 65/65mm
31210-10	Asta 39mm completa + lama per sega Ø 65mm + disco eccentrico
31206-00	Asta 39mm completa + lama a taglio di profondità 8mm
31205-00	Asta 39mm completa + lama a taglio di profondità 20mm
31200-58	Asta 58mm sola
31201-58	Asta 58mm completa
31203-20	Asta 58mm completa + lama per sega Ø 50mm
31203-30	Asta 58mm completa + lama per sega Ø 65mm
31204-20	Asta 58mm completa + lama per sega a segmento 50/65mm
31204-30	Asta 58mm completa + lama per sega a segmento 65/65mm
31210-00	Asta 58mm completa + lama per sega Ø 65mm + disco eccentrico
31206-10	Asta 58mm completa + lama a taglio di profondità 8mm
31205-10	Asta 58mm completa + lama a taglio di profondità 20mm
31200-70	Sega a doppia lama sola
31201-70	Sega a doppia lama completa
31202-00	Sega a doppia lama completa + lama per sega Ø 45mm + lame per sega regolabile Ø 45mm
31201-45	lame per sega regolabile Ø 45mm completa
31200-96	tornillo con hembra hexagonal para hoja de sierra ajustable Ø 45mm completa
31200-98	brugola per asta
31200-99	anello di ricambio per asta

Oszillierende Gipssäge  
Oscillating Plaster Saw  
Sierra oscilante p. vendajes enyesados  
Sega oscillante per gessi

Geräuschpegel: 52 - 77 db (A)  
Noise level: 52 - 77 db (A)  
Nivel de ruido del aparato sólo: 52 - 77 db (A)  
Livello acustico dello strumento solo: 52 - 77 db (A)

6500-24000 Schwingungen pro Minute  
6500-24000 oscillations per minute  
6500-24000 oscilaciones por minuto  
6500-24000 oscillazioni al minute

EN 60601-1, EN 60601-1-2, IEC 60601-1, IEC 60601-1-2



31210-21 120 Volt, 500 Watt, 1,5 kg

31210-22 230 Volt, 500 Watt, 1,5 kg

**31210-21 + 31210-22 inklusive, inclusive, inclusive, inclusive:**

1x 31210-50 Ø 50mm Sägeblatt, saw blade, hoja de repuesto, lama per sega

1x 31210-65 Ø 65mm Sägeblatt, saw blade, hoja de repuesto, lama per sega

1x 31212-02 Paar Gabelschlüssel, pair flat wrench, pareja llave de boca, paio chiave a bocca, 11mm

Zubehör für oszillierende Gipssäge 31210-22 und 31210-21 siehe Seite 230/14 - 230/18  
Accessories for oscillating plaster saw 31210-22 and 31210-21 please see page 230/14 - 230/18  
Accesorios p. sierra oscilante p. vendajes enyesados 31210-22 y 31210-21 vea la página 230/14 - 230/18  
Accessorio per sega oscillante per gessi 31210-22 e 31210-21 vedi pagina 230/14 - 230/18

- 31212-02 1 Paar Gabelschlüssel, pair flat wrench, pareja llave de boca, paio chiave a bocca, 11mm  
31210-30 Koffer, case, maleta, valigia

**Naturgipsverbände / bandage / vendajes enyesados / bandaggio in gesso**

- 31210-45 Ø 45mm Sägeblatt, saw blade, hoja de repuesto, lama per sega  
31210-50 Ø 50mm Sägeblatt, saw blade, hoja de repuesto, lama per sega  
31210-65 Ø 65mm Sägeblatt, saw blade, hoja de repuesto, lama per sega  
31204-01 Ø 50/65mm Segment-Sägeblatt, segment saw blade, hoja de repuesto para segmento, lama per sega a segmento  
31204-03 Ø 65/65mm Segment-Sägeblatt, segment saw blade, hoja de repuesto para segmento, lama per sega a segment  
31205-08 8mm Tiefen-Sägeblatt, deep cutting saw, hoja de sierra de profundidad, lama a taglio di profondità  
31205-20 20mm Tiefen-Sägeblatt, deep cutting saw, hoja de sierra de profundidad, lama a taglio di profondità

**synthetische Hartverbände / synthetic bandage / vendajes sinteticos / bandaggio sintetico**

- 31211-45 Ø 45mm Sägeblatt, saw blade, hoja de repuesto, lama per sega  
31211-50 Ø 50mm Sägeblatt, saw blade, hoja de repuesto, lama per sega  
31211-65 Ø 65mm Sägeblatt, saw blade, hoja de repuesto, lama per sega  
31204-02 Ø 50/65mm Segment-Sägeblatt, segment saw blade, hoja de repuesto para segmento, lama per sega a segmento  
31204-04 Ø 65/65mm Segment-Sägeblatt, segment saw blade, hoja de repuesto para segmento, lama per sega a segment  
31205-09 8mm Tiefen-Sägeblatt, deep cutting saw, hoja de sierra de profundidad, lama a taglio di profondità  
31205-21 20mm Tiefen-Sägeblatt, deep cutting saw, hoja de sierra de profundidad, lama a taglio di profondità

**PTFE synthetische Hartverbände / PTFE synthetic bandage / PTFE vendajes sinteticos / PTFE bandaggio sintetico**

- 31212-50 Ø 50mm Sägeblatt, saw blade, hoja de repuesto, lama per sega  
31212-65 Ø 65mm Sägeblatt, saw blade, hoja de repuesto, lama per sega

**Naturgipsverbände und synthetische Hartverbände / Bandage and synthetic bandage / Vendajes enyesados y vendajes sinteticos / Bandaggio in gesso e bandaggio sintetico**

- 31203-50 Begrenzungsscheibe, limiting disc, disco de tope, disco eccentrico

Oszillierende Gipssäge  
Oscillating Plaster Saw  
Sierra oscilante p. vendajes enyesados  
Sega oscillante per gessi

Geräuschpegel: 52 - 77 db (A)  
Noise level: 52 - 77 db (A)  
Nivel de ruido del aparato sólo: 52 - 77 db (A)  
Livello acustico dello strumento solo: 52 - 77 db (A)

10000-19000 Schwingungen pro Minute  
10000-19000 oscillations per minute  
10000-19000 oscilaciones por minuto  
10000-19000 oscillazioni al minute

EN 60601-1, EN 60601-1-2, IEC 60601-1, IEC 60601-1-2



**Blue Power**

31220-21	120 Volt, 210 Watt, 1,25 kg
31220-22	230 Volt, 210 Watt, 1,25 kg

**31220-21 + 31220-22 inklusive, inclusive, inclusive, inclusive:**

- 1x 31210-50 Ø 50mm Sägeblatt, saw blade, hoja de repuesto, lama per sega
- 1x 31210-65 Ø 65mm Sägeblatt, saw blade, hoja de repuesto, lama per sega
- 1x 31212-02 Paar Gabelschlüssel, pair flat wrench, pareja llave de boca, paio chiave a bocca, 11mm

Zubehör für oszillierende Gipssäge 31220-22 und 31220-21 siehe Seite 231/2  
Accessories for oscillating plaster saw 31220-22 and 31220-21 please see page 231/2  
Accesorios p. sierra oscilante p. vendajes enyesados 31220-22 y 31220-21 vea la página 231/2  
Accessorio per sega oscillante per gessi 31220-22 e 31220-21 vedi pagina 231/2

- 31212-02 1 Paar Gabelschlüssel, pair flat wrench, pareja llave de boca, paio chiave a bocca, 11mm  
31210-30 Koffer, case, maleta, valigia  
31220-99 Filtervlies, woven filter, filtro de vellón, filtro vello  
10 Stück, 10 pieces, 10 piezas, 10 pezzi

#### **Naturgipsverbände / bandage / vendajes enyesados / bandaggio in gesso**

- 31210-45 Ø 45mm Sägeblatt, saw blade, hoja de repuesto, lama per sega  
31210-50 Ø 50mm Sägeblatt, saw blade, hoja de repuesto, lama per sega  
31210-65 Ø 65mm Sägeblatt, saw blade, hoja de repuesto, lama per sega  
31204-01 Ø 50/65mm Segment-Sägeblatt, segment saw blade, hoja de repuesto para segmento, lama per sega a segmento  
31204-03 Ø 65/65mm Segment-Sägeblatt, segment saw blade, hoja de repuesto para segmento, lama per sega a segment  
31205-08 8mm Tiefen-Sägeblatt, deep cutting saw, hoja de sierra de profundidad, lama a taglio di profondità  
31205-20 20mm Tiefen-Sägeblatt, deep cutting saw, hoja de sierra de profundidad, lama a taglio di profondità

#### **synthetische Hartverbände / synthetic bandage / vendajes sinteticos / bandaggio sintetico**

- 31211-45 Ø 45mm Sägeblatt, saw blade, hoja de repuesto, lama per sega  
31211-50 Ø 50mm Sägeblatt, saw blade, hoja de repuesto, lama per sega  
31211-65 Ø 65mm Sägeblatt, saw blade, hoja de repuesto, lama per sega  
31204-02 Ø 50/65mm Segment-Sägeblatt, segment saw blade, hoja de repuesto para segmento, lama per sega a segmento  
31204-04 Ø 65/65mm Segment-Sägeblatt, segment saw blade, hoja de repuesto para segmento, lama per sega a segment  
31205-09 8mm Tiefen-Sägeblatt, deep cutting saw, hoja de sierra de profundidad, lama a taglio di profondità  
31205-21 20mm Tiefen-Sägeblatt, deep cutting saw, hoja de sierra de profundidad, lama a taglio di profondità

#### **PTFE synthetische Hartverbände / PTFE synthetic bandage / PTFE vendajes sinteticos / PTFE bandaggio sintetico**

- 31212-50 Ø 50mm Sägeblatt, saw blade, hoja de repuesto, lama per sega  
31212-65 Ø 65mm Sägeblatt, saw blade, hoja de repuesto, lama per sega

#### **Naturgipsverbände und synthetische Hartverbände / Bandage and synthetic bandage / Vendajes enyesados y vendajes sinteticos / Bandaggio in gesso e bandaggio sintetico**

- 31203-50 Begrenzungsscheibe, limiting disc, disco de tope, disco eccentrico

Sägeblätter  
Saw blades  
Hojas de repuesto  
Lame per sega

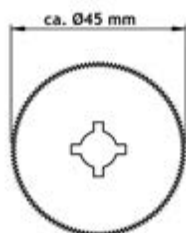

31210-45  
31211-45

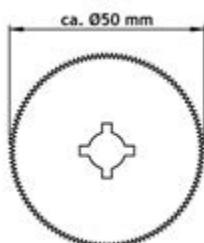

31210-50  
31211-50  
31212-50

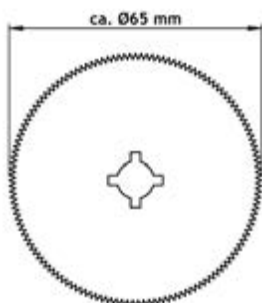

31210-65  
31211-65  
31212-65



Segment-Sägeblätter  
Segment saw blades  
Hojas de repuesto para segmento,  
Lame per sega a segment

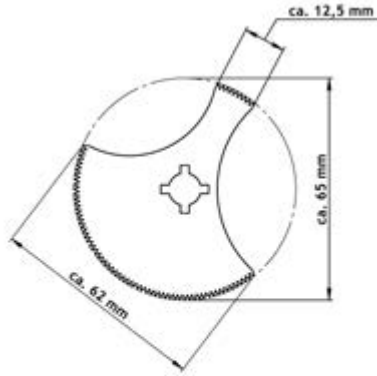

31204-01    Ø 50/65mm  
31204-02    Ø 50/65mm

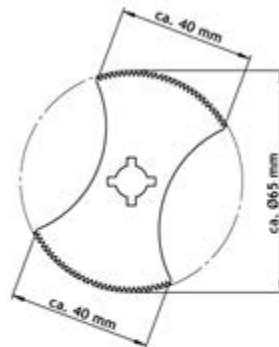

31204-03    Ø 65/65mm  
31204-04    Ø 65/65mm

Tiefen-Sägeblätter  
 depp cutting saw  
 Hojas de sierra de profundidad,  
 Lame a taglio di profondità

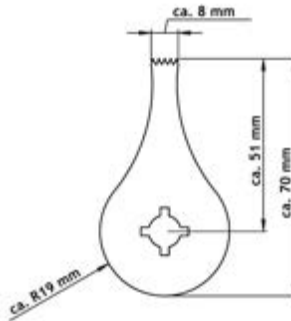

31205-08 8mm  
 31205-09 8mm

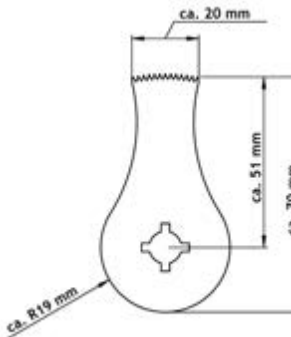
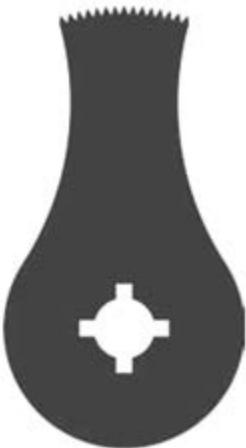

31205-20 20mm  
 31205-21 20mm

Sägeblätter  
Saw blades  
Hojas de repuesto  
Lame per sega



31203-50

Begrenzungsscheibe  
Limiting disc  
Disco de tope  
Disco eccentrico

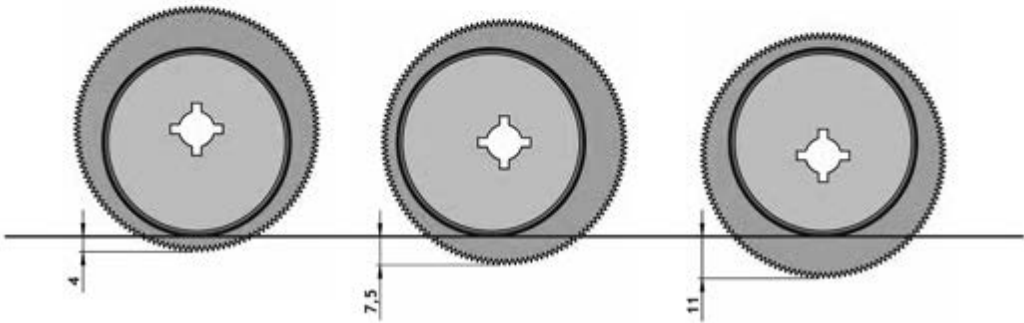

31203-50  
für Sägeblatt mit Ø 65mm  
for Saw blade with Ø 65mm  
para hoja de sierra Ø 65mm  
per lama di sega Ø 65mm

31210-65  
31204-01  
31204-03  
31211-65  
31204-02  
31204-04  
31212-65

Zubehör  
Accessories  
Accessorio  
Accessori



31200-95



31202-16



31210-30



31212-02, 11 mm  
31202-14, 14 mm



31220-99  
10 Stück  
10 pieces  
10 piezas  
10 pezzi



Absauganlage und Wagen ohne Gipsäge  
 Hoover and carriage without plaster saw  
 Aspirador y careta sin sierra  
 Aspirazione e carello senza sega

31252-11 120 Volt, 500 - 1250 Watt (1250 PT), 19 kg

31252-22 230 Volt, 500 - 1200 Watt (1450 PT), 19 kg

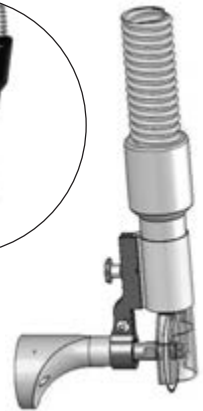

Aufgebaute Einheit  
 Set-up unit

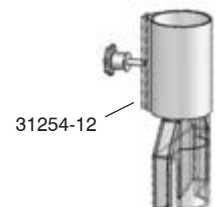
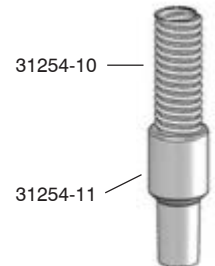

31253-00 230 Volt  
 31253-11 120 Volt

Zubehör für 31252-22 und 31252-11  
Accessories for 31252-22 and 31252-11  
Accesorios para 31252-22 y 31252-11  
Accessorio per 31252-22 e 31252-11

- 31253-00 230 Volt, Staubsauger, Hoover, aspirador, aspirapolvere
- 31253-11 120 Volt, Staubsauger, Hoover, aspirador, aspirapolvere
- 31254-10 Saugschlauch 3,3 Meter, schwarz, suction hose 3,3 meter, black, manguera de aspiracion 3,3 metros, negra, tubo di aspirazione 3,3 metri, nera
- 31254-11 Saugdüse schwarz, suction nozzle black, boquilla aspirante negra, ugello aspirante nero
- 31254-12 Saughaube kpl., suction cover cpl., cofia de aspiracion cpl., cuffia di aspirazione cpl.
- 31250-10 Set Filtertüten, set filter paper, set de filtros, set di filtros:  
1x 31250-15  
6x 31250-12  
6x 31250-14

31250-12



Staubbeutel, Ather, antera, antera

31250-13



Motorfilter, motor filter, filtro para motor, filtro per motore

31250-14



Duftstick, flavor stick, stick de aroma, stick di effluvio

31250-15



HEPA-Filter, HEPA-Filter, filtro HEPA, filtro HEPA,

Gipsspreizer  
Plaster Cast Instruments  
Instrumentos para vendajes enyesados  
Allargagessi

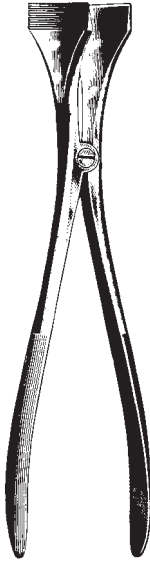

HENNIG  
31350-28 28 cm, 11"

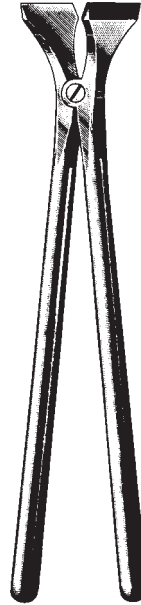

BEESON  
31360-30 30 cm, 11 3/4"

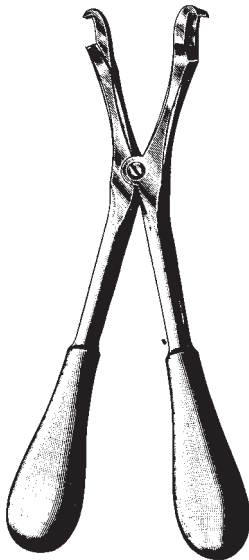

HAGLUND-STILLE  
31362-28 28 cm, 11"



REDA  
31366-23 23 cm, 9"



Gipsmesser, Gipsabreißzangen  
Plaster Cast Instruments, Knives  
Instrumentos para vendajes enyesados, Cuchillos  
Allargagessi, Coltelli per Gessi, Strappagessi



HOPKINS  
31370-20  
20 cm, 8"



ESMARCH  
31380-18  
18 cm, 7"



REINER  
31390-18  
18 cm, 7"



WOLFF  
31395-18  
18 cm, 7"



WOLFF  
31397-24  
24 cm, 9 1/2"

Hohlmeißelzangen  
 Bone Rongeurs  
 Pinzas-gubias  
 Pinze sgorbie

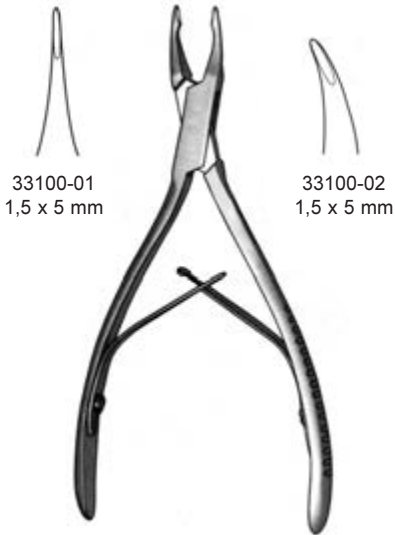

**MICRO FRIEDMAN**  
14 cm, 5 1/2"



**FRIEDMAN Mini**  
33101-12 12 cm, 4 3/4"



**FRIEDMAN**  
33101-14 14 cm, 5 1/2"

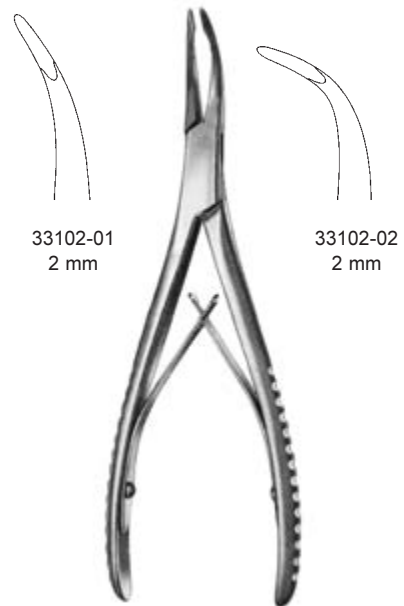

**STELLBRINK**  
17 cm, 6 3/4"

Hohlmeißelzangen  
Bone Rongeurs  
Pinzas-gubias  
Pinze sgorbie



CLEVELAND  
33103-14 14 cm, 5 1/2"

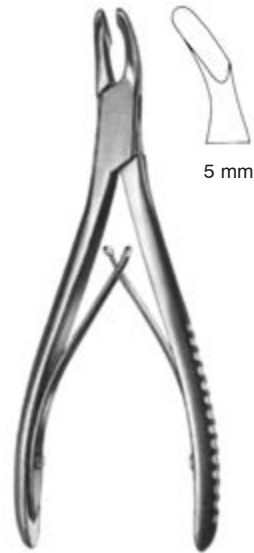

CLEVELAND  
33105-17 17 cm, 6 3/4"



MEAD  
33107-16 16,5 cm, 6 1/2"

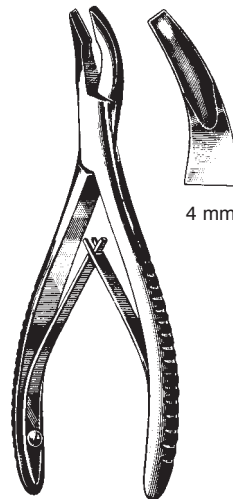

MEAD  
33109-16 16,5 cm, 6 1/2"

Hohlmeißelzangen  
 Bone Rongeurs  
 Pinzas-gubias  
 Pinze sgorbie

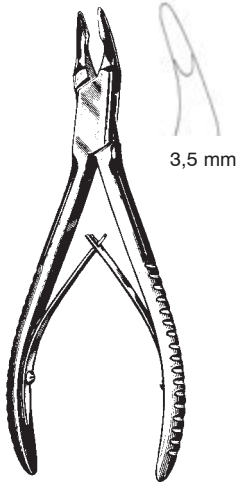

3,5 mm

BLUMENTHAL  
 33115-15  
 15,5 cm, 6"

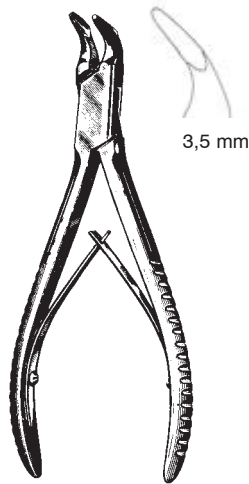

3,5 mm

BLUMENTHAL  
 33117-15  
 15,5 cm, 6"

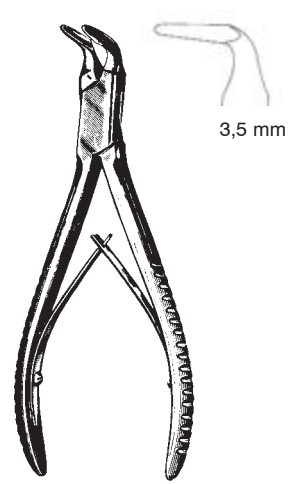

3,5 mm

BLUMENTHAL  
 33119-15  
 15,5 cm, 6"



4,5 mm

LUER  
 33131-15  
 15 cm, 5.9"



4 mm

LUER  
 33133-15  
 15 cm, 5.9"

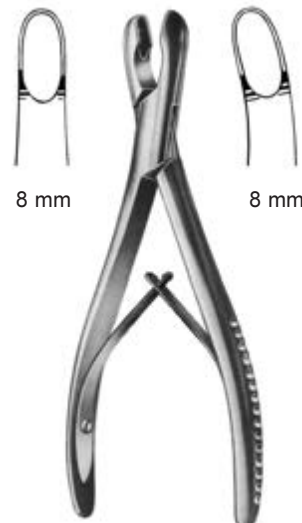

8 mm

8 mm

— LUER —  
 33136-17 33137-17  
 17 cm, 6 3/4"



9 mm

— ADSON —  
 33142-20 33143-20  
 20 cm, 7.9"

Hohlmeißelzangen  
 Bone Rongeurs  
 Pinzas-gubias  
 Pinze sgorbie



**OLIVECRONA**  
 33147-20  
 20 cm, 7.9"



**BANE-HARTMANN**  
 33148-18  
 17,5 cm, 7"



**LEMPERT**  
 33150-16 33151-16  
 16 cm, 6 1/4"

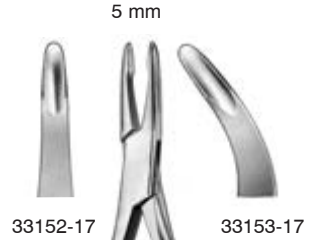

33152-17 33153-17

**JANSEN**  
 17 cm, 6 3/4"



**LEMPERT**  
 33154-18 33155-18  
 18,5 cm, 7 1/4"



**BEYER**  
 33156-18  
 18 cm, 7"

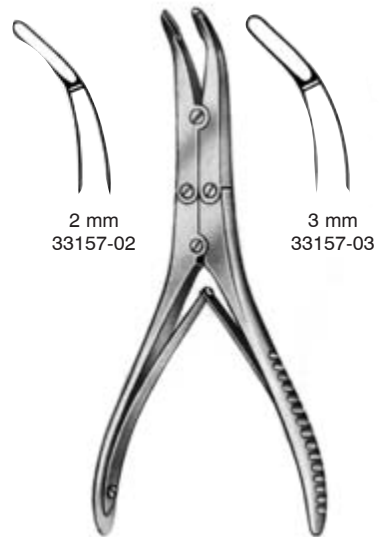

**KLEINERT-KUTZ**  
 15 cm, 6"

Hohlmeißelzangen  
 Bone Rongeurs  
 Pinzas-gubias  
 Pinze sgorbie



3 mm  
33157-04



4 mm  
33157-05



5 mm  
33157-06



3 mm  
33158-03



4 mm  
33158-04



5 mm  
33158-05



3 mm  
33159-03



4 mm  
33159-04



5 mm  
33159-05



SMITH-PETERSEN  
24 cm, 9 1/2"



BEYER  
33201-18  
18 cm, 7"



MAYFIELD  
33202-18  
18 cm, 7"



ZAUFAL-JANSEN  
33205-18  
18 cm, 7"



BÖHLER  
33211-15 33213-15  
15 cm, 6"

Hohlmeißelzangen  
 Bone Rongeurs  
 Pinzas-gubias  
 Pinze sgorbie

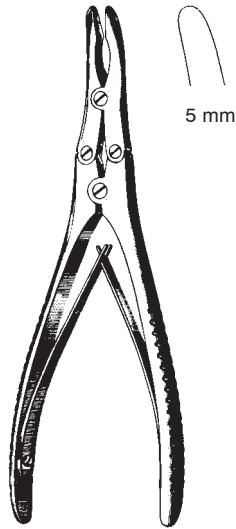

**RUSKIN**  
 33216-18 33217-18  
 18 cm, 7"

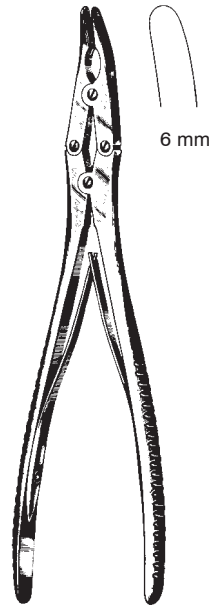

**RUSKIN**  
 33219-23 23 cm, 9"



**MARQUARDT**  
 33220-20 20 cm, 8"

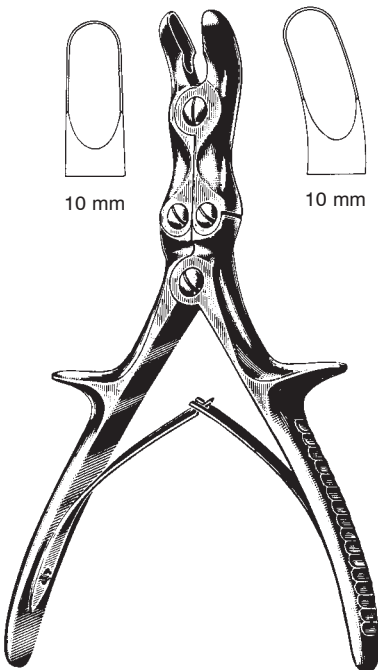

**STILLE-LUER**  
 33230-22 22 cm, 8 3/4" 33231-22  
 33230-26 26 cm, 10 1/4" 33231-26



**STILLE-LUER**  
 33235-23  
 23 cm, 9"



**STILLE-RUSKIN**  
 33237-23  
 23 cm, 9"

Hohlmeißelzangen  
 Bone Rongeurs  
 Pinzas-gubias  
 Pinze scorbie

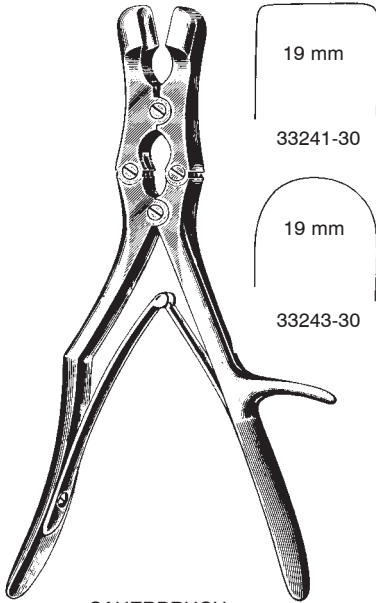

SAUERBRUCH  
 30 cm, 10 3/4"

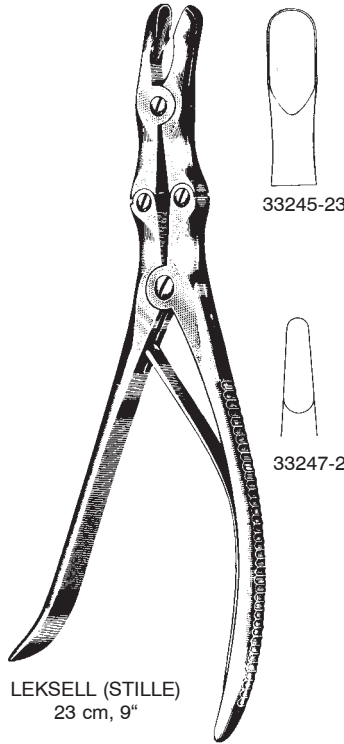
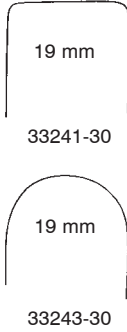

LEKSELL (STILLE)  
 23 cm, 9"

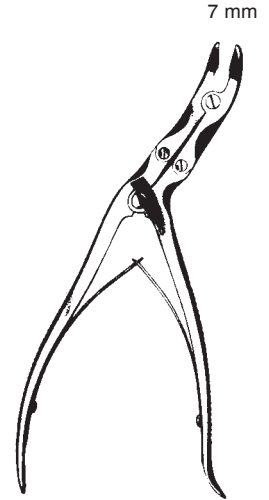

SCAGLIETTI  
 33251-26 rechts right derecha a destra  
 26 cm, 10 1/4"  
 33253-26 links left izquierda a sinistra



ECHLIN  
 33257-23 2 mm  
 33258-23 4 mm  
 33259-23 3 mm  
 23 cm, 9"



FRYKHOLM  
 33260-24  
 24 cm, 9 1/2"



SEMB  
 33261-22  
 22,5 cm, 8.9"



Knochensplitterzangen  
 Bone Cutting Forceps  
 Pinzas cortantes para huesos  
 Cesioie per ossa

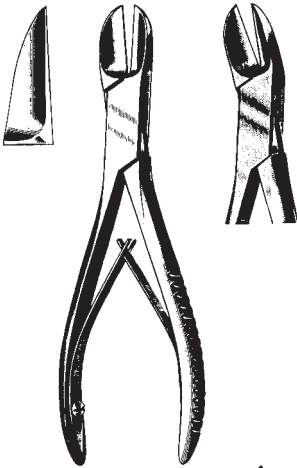

LISTON

- |          |               |          |
|----------|---------------|----------|
| 33274-14 | 14 cm, 5 1/2" | 33275-14 |
| 33274-17 | 17 cm, 6 3/4" | 33275-17 |
| 33274-19 | 19 cm, 7 1/2" | 33275-19 |
| 33274-22 | 22 cm, 8 3/4" | 33275-22 |



BÖHLER

- |           |          |
|-----------|----------|
| 33280-15  | 33281-15 |
| 15 cm, 6" |          |



COTTLE-KAZANJIAN

- |               |
|---------------|
| 33282-19      |
| 19 cm, 7 1/2" |



MC INDOE

- |               |
|---------------|
| 33283-17      |
| 17 cm, 6 3/4" |



STAMM

- |           |
|-----------|
| 33284-15  |
| 15 cm, 6" |

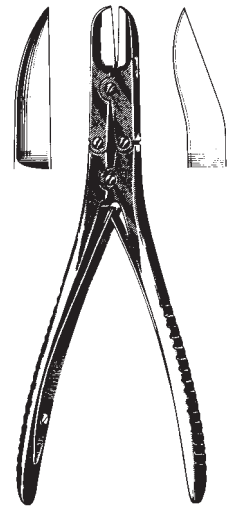

RUSKIN-LISTON

- |           |          |
|-----------|----------|
| 33286-18  | 33289-18 |
| 18 cm, 7" |          |

Knochensplitterzangen  
 Bone Cutting Forceps  
 Pinzas cortantes para huesos  
 Cesoiè per ossa

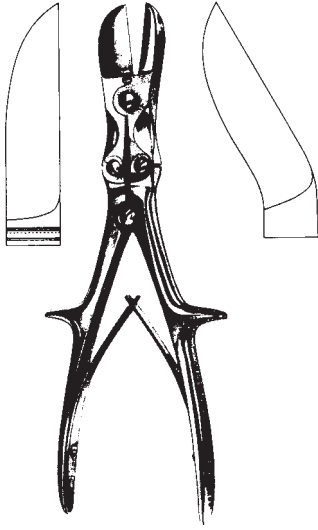

STILLE-LISTON  
 33290-23 23 cm, 9" 33291-23  
 33290-27 27 cm, 10 1/2" 33291-27



STILLE-LISTON  
 33292-26  
 26 cm, 10 1/4"

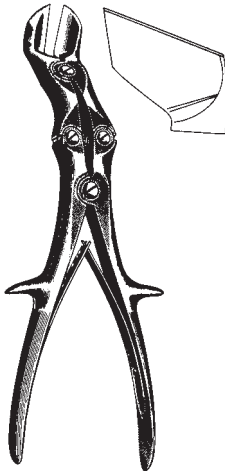

STILLE-HORSLEY  
 33293-27  
 27 cm, 10 1/2"

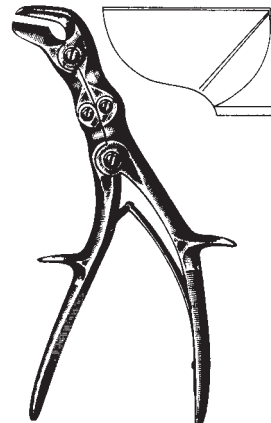

SEMB  
 33295-24  
 24 cm, 9 1/2"

Knochenhaltezangen  
 Bone Holding Forceps  
 Pinzas para huesos  
 Tenaglie per ossa

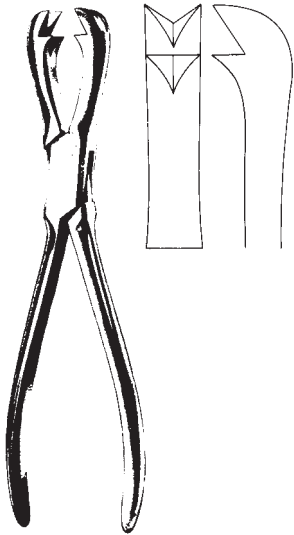

**FERGUSSON**  
 33360-21  
 21 cm, 8 1/4"

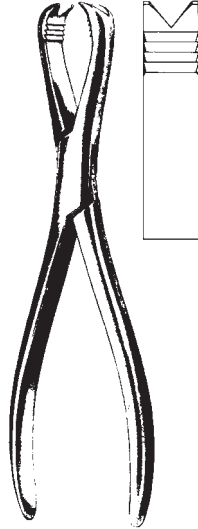

**LANGENBECK**  
 33362-21  
 21 cm, 8 1/4"

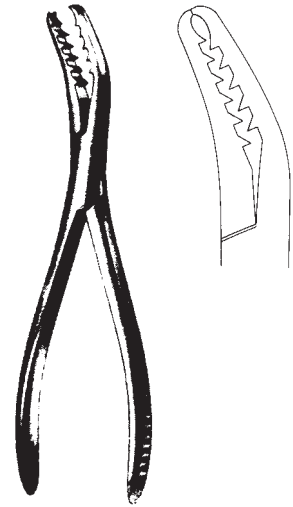

**SEMB**  
 33365-19  
 19 cm, 7 1/2"



**SEMB**  
 33366-19  
 20 cm, 8"



**FARABEU**  
 33366-23 23 cm, 9"  
 33366-26 26 cm, 10 1/4"



**FARABEU-F-LAMBOTTE**  
 33368-26  
 26 cm, 10 1/4"

Knochenhalte­zangen  
Bone Holding Forceps  
Pinzas para huesos  
Tenaglie per ossa

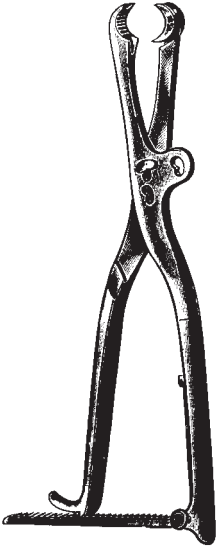

LAMBOTTE

33370-22 22 cm, 8 <sup>3</sup>/<sub>4</sub>"  
33370-27 27 cm, 10 <sup>1</sup>/<sub>2</sub>"  
33370-30 30 cm, 11 <sup>3</sup>/<sub>4</sub>"

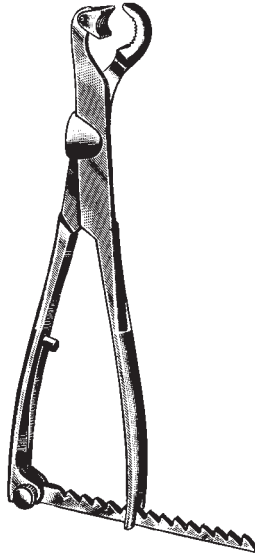

LAMBOTTE

33372-22 22 cm, 8 <sup>3</sup>/<sub>4</sub>"  
33372-26 26 cm, 10 <sup>1</sup>/<sub>4</sub>"  
33372-33 33 cm, 13"

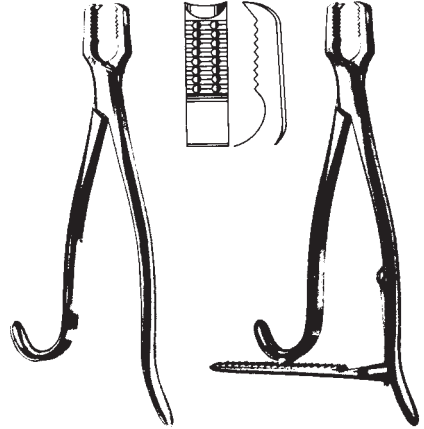

KERN

33378-15 15 cm, 6" 33380-15  
33378-17 17 cm, 6 <sup>3</sup>/<sub>4</sub>" 33380-17  
33378-21 21 cm, 8 <sup>1</sup>/<sub>4</sub>" 33380-21



LANE

33382-33 33 cm, 13"  
33382-45 45 cm, 17 <sup>3</sup>/<sub>4</sub>"

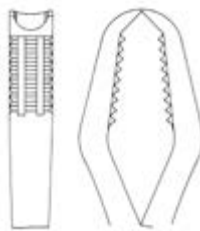

LANE

33384-33 33 cm, 13"  
33384-45 45 cm, 17 <sup>3</sup>/<sub>4</sub>"

Knochenhaltezangen  
 Bone Holding Forceps  
 Pinzas para huesos  
 Tenaglie per ossa

selbstzentrierend  
 self-centering  
 autocentrantes  
 autocentranti

2,5 mm



33391-15  
 15 cm, 6"

6,5 mm

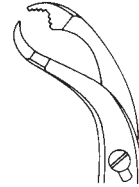

33391-19  
 19 cm, 7 1/2"

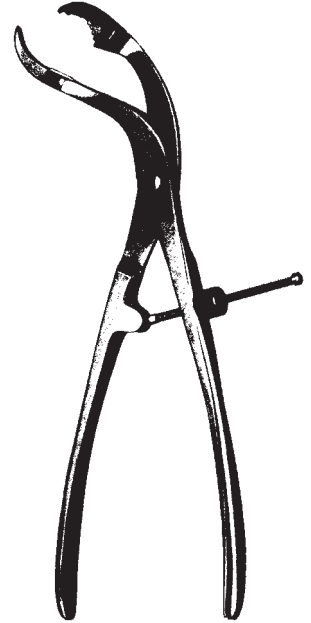

33391-15 - 33391-28

9,5 mm

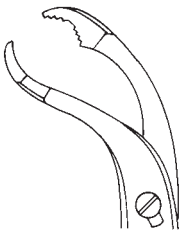

33391-24  
 24 cm, 9 1/2"

10 mm

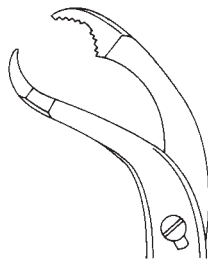

33391-26  
 26 cm, 10 1/4"

11 mm

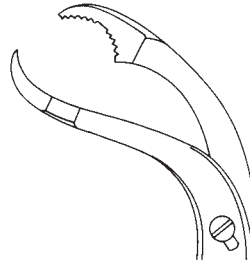

33391-28  
 28 cm, 11"

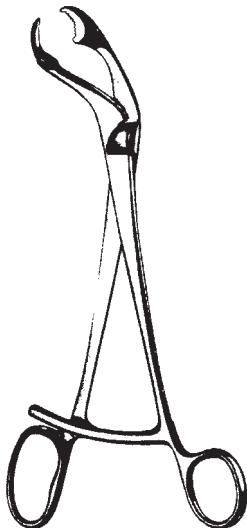

VERBRUGGE  
 33395-17 - 33395-27

5 mm



33395-17  
 17,5 cm, 7"

9,5 mm

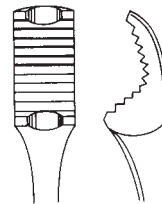

33395-25  
 25 cm, 10"

10,5 mm

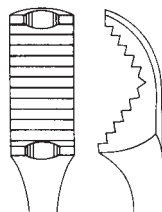

33395-26  
 26 cm, 10 1/4"

12 mm

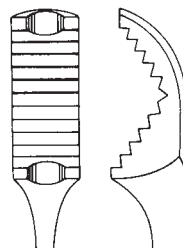

33395-27  
 27 cm, 10 1/2"

Knochenhalte­zangen  
Bone Holding Forceps  
Pinzas para huesos  
Tenaglie per ossa

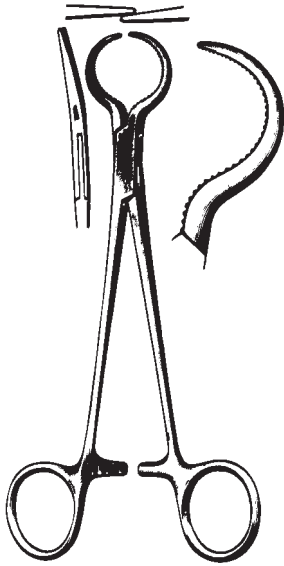

LEWIN  
33402-17  
17,5 cm, 7"

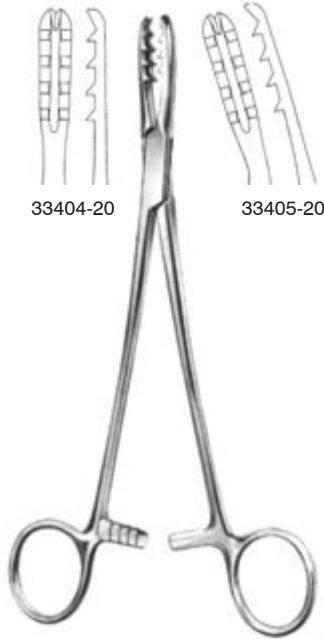

33404-20

33405-20

BIRCHER-GANSKE  
20 cm, 8"



33406-20  
20 cm, 8"



DINGMANN  
33407-19  
19 cm, 7 1/2"



REDA  
33409-13  
13,5 cm, 5 1/4"



MARTIN  
33410-19  
19 cm, 7 1/2"

Knochenhaltezangen  
Bone Holding Forceps  
Pinzas para huesos  
Tenaglie per ossa



REDA  
33412-16 - 33412-24

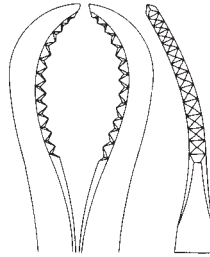

33412-16  
16 cm, 6 1/4"

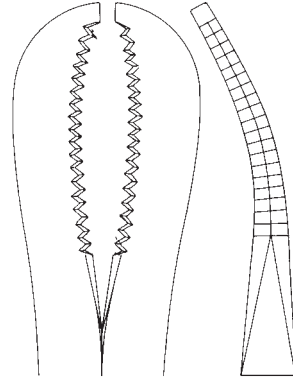

33412-24  
24 cm, 9 1/2"

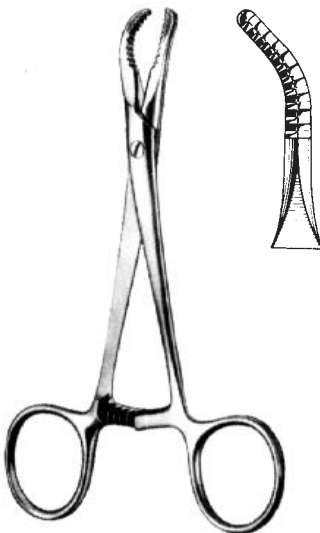

REDA  
33413-14  
13,5 cm, 5 1/4"



33414-21  
21 cm, 8 1/4"

Knochenhaltezaugen  
 Bone Holding Forceps  
 Pinzas para huesos  
 Tenaglie per ossa

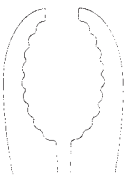

ULRICH  
 33415-23 - 33415-28

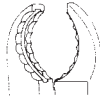

33415-23  
 23 cm, 9"

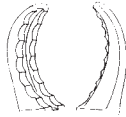

33415-25  
 25 cm, 10"

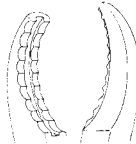

33415-28  
 28 cm, 11"

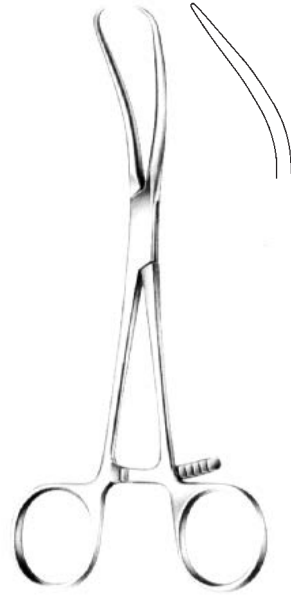

REILL  
 33416-17 17 cm, 6 3/4"



PATELLA  
 33417-18 18,5 cm, 7 1/4"



MEYER  
 33418-17 17 cm, 6 3/4"



MEYER  
 33419-20 20,5 cm, 8"



Knochenhaltezangen, -Klammern  
 Bone holding forceps, -Clamps  
 Pinzas para huesos, Clamps porta-huesos  
 Tenaglie per ossa, Pinze per ossa

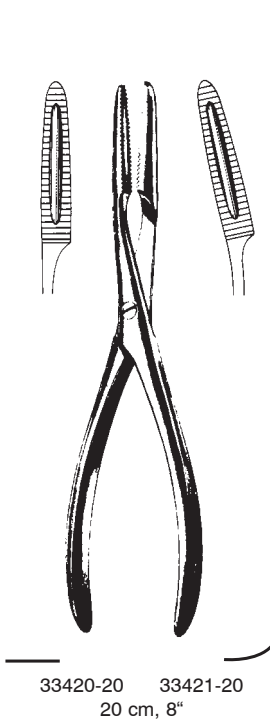

Knochenhalte­zangen, Bleihand  
 Bone holding forceps, Lead Hands  
 Pinzas para huesos, Manoplas de plomo  
 Tenaglie per ossa, Mani di piombo

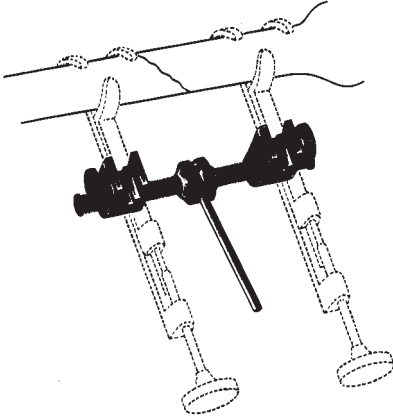

GERSTER  
 33444-15



33450-01  
 32 cm, 12 <sup>3</sup>/<sub>4</sub>"  
 Erwachsen  
 adult size  
 p. adultos  
 p. adulti

33450-02  
 24 cm, 9 <sup>1</sup>/<sub>2</sub>"  
 Kind  
 child size  
 p. niños  
 p. bambini

Scharfe Löffel  
Bone Curettes  
Cucharillas cortantes  
Curette taglienti

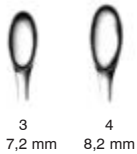
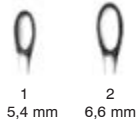

SCHEDE	Fig.	VOLKMANN
	0000	33469-96
33467-97	000	33469-97
33467-98	00	33469-98
33468-00	0	33470-00
33468-01	1	33470-01
33468-02	2	33470-02
33468-03	3	33470-03
33468-04	4	33470-04
	5	33470-05
	6	33470-06

SCHEDE  
17 cm, 6 3/4"  
33467-97 - 33468-04

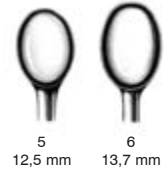

VOLKMANN  
17 cm, 6 3/4"  
33469-96 - 33470-06

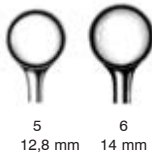

BRUNS	Fig.	SPRATT
33471-96	0000	33474-96
33471-97	000	33474-97
33471-98	00	33474-98
33472-00	0	33475-00
33472-01	1	33475-01
33472-02	2	33475-02
33472-03	3	33475-03
33472-04	4	33475-04
33472-05	5	33475-05
33472-06	6	33475-06

BRUNS  
17 cm, 6 3/4"  
33471-96 - 33472-06

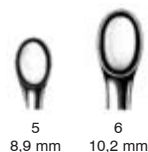
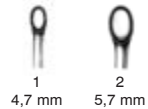
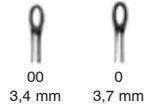
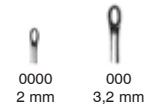

SPRATT  
17 cm, 6 3/4"  
33474-97 - 33475-06

Scharfe Löffel  
 Bone Currettes  
 Cucharillas cortantes  
 Curette taglienti

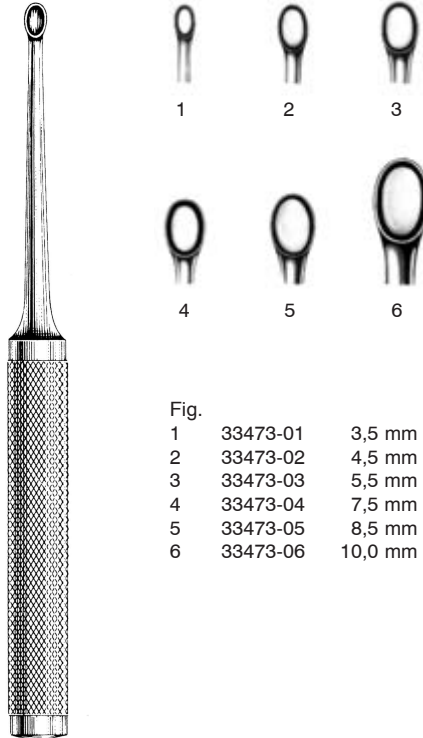

COBB  
 27,9 cm 11"

Fig.		
1	33473-01	3,5 mm
2	33473-02	4,5 mm
3	33473-03	5,5 mm
4	33473-04	7,5 mm
5	33473-05	8,5 mm
6	33473-06	10,0 mm

Scharfe Löffel  
Bone Curettes  
Cucharillas cortantes  
Curette taglienti

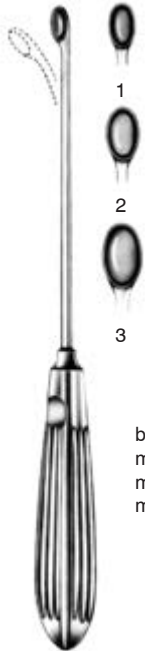

- Fig.  
1 33476-01 4,8 mm  
2 33476-02 5,8 mm  
3 33476-03 6,8 mm

biegsam  
malleable  
malleable  
malleabile

HALLE  
21 cm, 8 1/4"

33476-01 - 33476-02



- Fig.  
000 33476-98 2,8 mm  
00 33476-99 3,3 mm  
0 33477-00 3,7 mm  
1 33477-01 4,3 mm  
2 33477-02 4,8 mm  
3 33477-03 5,6 mm  
4 33477-04 6,1 mm  
5 33477-05 6,7 mm  
6 33477-06 8,8 mm

SPINAL  
20 cm, 8"

33476-98 - 33477-06

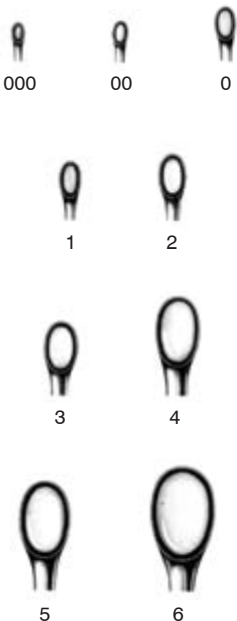

- Fig.  
000 33478-98 2,8 mm  
00 33478-99 3,3 mm  
0 33479-00 3,7 mm  
1 33479-01 4,3 mm  
2 33479-02 4,8 mm  
3 33479-03 5,6 mm  
4 33479-04 6,1 mm  
5 33479-05 6,7 mm  
6 33479-06 8,8 mm



SPINAL  
20 cm, 8"

33478-98 - 33479-06



33482-01 4,7 mm



33482-02 4,7 mm



33482-03 4,7 mm

SCOVILLE  
25 cm, 10"

33482-01 - 33482-03

Scharfe Löffel  
Bone Currettes  
Cucharillas cortantes  
Curette taglianti

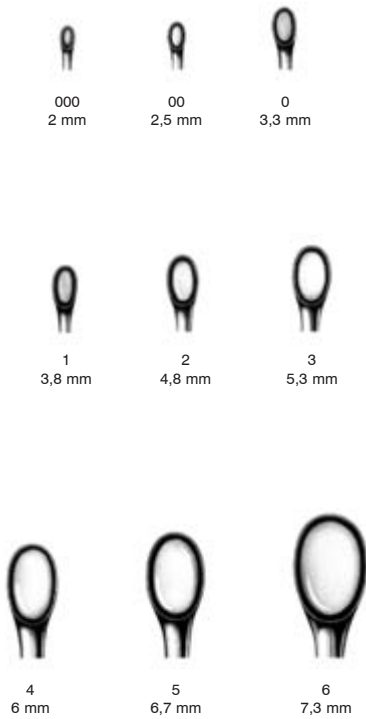

BRUNS  
23 cm, 9"



BRUNS  
23 cm, 9"



BRUNS  
23 cm, 9"

Fig.

000	33480-97	33482-97 2,8 mm	33484-97 2,8 mm
00	33480-98	33482-98 3,3 mm	33484-98 3,3 mm
0	33481-00	33483-00 3,7 mm	33485-00 3,7 mm
1	33481-01	33483-01 4,3 mm	33485-01 4,3 mm
2	33481-02	33483-02 4,8 mm	33485-02 4,8 mm
3	33481-03	33483-03 5,6 mm	33485-03 5,6 mm
4	33481-04	33483-04 6,1 mm	33485-04 6,1 mm
5	33481-05	33483-05 6,7 mm	33485-05 6,7 mm
6	33481-06	33483-06 8,8 mm	33485-06 8,8 mm

Scharfe Löffel  
Bone Curettes  
Cucharillas cortantes  
Curette taglienti



33485-21 21 cm, 8 1/4"  
oval/rund  
ovale/ronde  
ovalado/redondo  
ovale/rotonda



WILLIGER  
17,5 cm  
7"

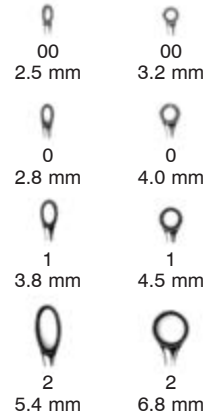

Fig. 00	33485-99	33486-99
0	33486-00	33487-00
1	33486-01	33487-01
2	33486-02	33487-02



DAUBENSPECK Fig. 00 33487-99  
20 cm, 8" 0 33488-00  
1 33488-01  
2 33488-02



27 cm Fig. 0 33489-00  
10 1/2" 1 33489-01  
2 33489-02  
3 33489-03



Scharfe Löffel  
 Bone Currettes  
 Cucharillas cortantes  
 Curette taglianti



LEMPERT  
 17,5 cm, 7"



0



00



000



0000



00000

Fig. 0	33490-10	3,3 mm
00	33490-20	3,0 mm
000	33490-30	2,7 mm
0000	33490-40	2,4 mm
00000	33490-50	2,0 mm



REDA  
 25 cm, 10"



000  
 3,6 mm



00  
 4,4 mm

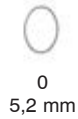

0  
 5,2 mm



1  
 6,8 mm

Fig. 000	33500-01
00	33500-02
0	33500-03



REDA  
 25 cm, 10"



000  
 3,6 mm



00  
 4,4 mm



0  
 5,2 mm

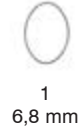

1  
 6,8 mm



BUSHE  
 25 cm, 10"

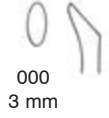

000  
 3 mm



00  
 4 mm



0  
 5 mm

Fig. 000	33491-05
00	33491-06
0	33491-07
1	33491-08



Scharfe Löffel  
Bone Curettes  
Cucharillas cortantes  
Curette taglienti

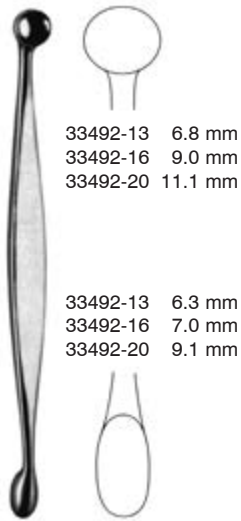

33492-13 6.8 mm  
33492-16 9.0 mm  
33492-20 11.1 mm

33492-13 6.3 mm  
33492-16 7.0 mm  
33492-20 9.1 mm

VOLKMANN

33492-13 13 cm, 5 1/8"  
33492-16 16 cm, 6 1/4"  
33492-20 20 cm, 8"

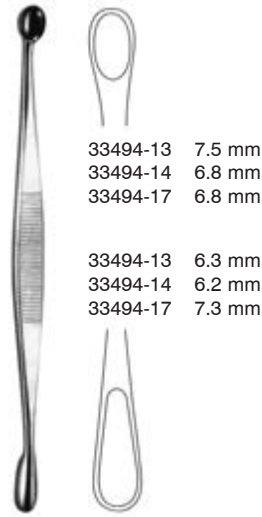

33494-13 7.5 mm  
33494-14 6.8 mm  
33494-17 6.8 mm

33494-13 6.3 mm  
33494-14 6.2 mm  
33494-17 7.3 mm

VOLKMANN

33494-13 13 cm, 5 1/8"  
33494-14 14 cm, 5 1/2"  
33494-17 17 cm, 6 3/4"



5.2 mm

3.5 mm

JANSEN

33495-16  
16 cm, 6 1/4"

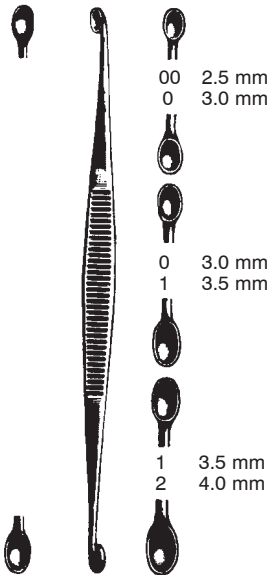

00 2.5 mm  
0 3.0 mm

0 3.0 mm  
1 3.5 mm

1 3.5 mm  
2 4.0 mm

WILLIGER

13,5 cm, 5 1/4" Fig.  
33496-00 00/0  
33496-01 0/1  
33496-12 1/2

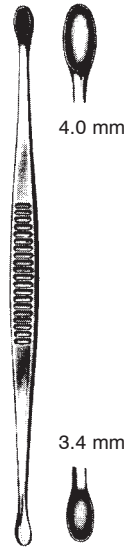

4.0 mm

3.4 mm

JACOBSON

13 cm, 5 1/8"  
33497-00

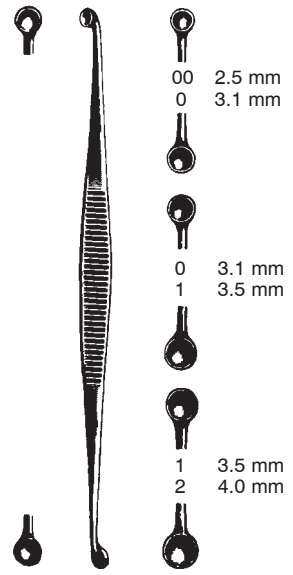

00 2.5 mm  
0 3.1 mm

0 3.1 mm  
1 3.5 mm

1 3.5 mm  
2 4.0 mm

MARTINI

13,5 cm, 5 1/4"  
33498-00  
33498-01  
33498-12

Stößel  
 Hemostats  
 Hemostáticos  
 Pistoni

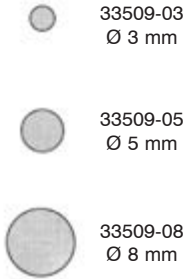

CASPAR  
 200 mm, 8"

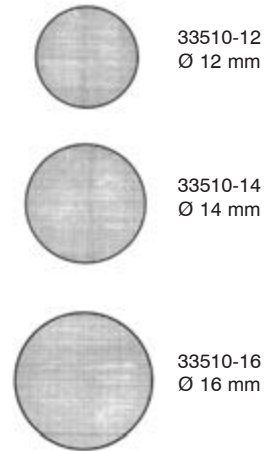

200 mm, 8"

Stößel, Flachmeißel, Hohlmeißel, Osteotome  
 Hemostats, Chisels, Gouges, Osteotome  
 Hemostáticos, Cinceles, Gubias, Osteótomo  
 Pistoni, scalpelli, sgorbie, Osteotomia

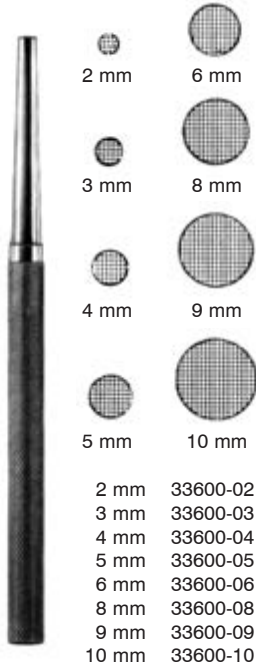

16 cm, 6 1/4"

2 mm	33600-02
3 mm	33600-03
4 mm	33600-04
5 mm	33600-05
6 mm	33600-06
8 mm	33600-08
9 mm	33600-09
10 mm	33600-10



13,5 cm, 5 1/4"

4 mm	33602-04
6 mm	33602-06
8 mm	33602-08
10 mm	33602-10
12 mm	33602-12
14 mm	33602-14
16 mm	33602-16



13,5 cm, 5 1/4"

33604-04
33604-06
33604-08
33604-10
33604-12
33604-14
33604-16



13,5 cm, 5 1/4"

33605-04
33605-06
33605-08
33605-10
33605-12
33605-14
33605-16



ALEXANDER  
17 cm, 6 3/4"

33610-04	4 mm
33610-06	6 mm
33610-08	8 mm
33610-10	10 mm
33610-12	12 mm
33610-14	14 mm



ALEXANDER  
17 cm, 6 3/4"

33611-04	4 mm
33611-06	6 mm
33611-08	8 mm
33611-10	10 mm
33611-12	12 mm
33611-14	14 mm



PARTSCH  
13,5 cm, 5 1/4" mm 17 cm, 6 3/4"

33620-02	2	33622-02
33620-03	3	33622-03
33620-04	4	33622-04
33620-05	5	33622-05
33620-06	6	33622-06
33620-07	7	33622-07
33620-08	8	33622-08



PARTSCH  
13,5 cm, 5 1/4" mm 17 cm, 6 3/4"

33623-02	2	33625-02
33623-03	3	33625-03
33623-04	4	33625-04
33623-05	5	33625-05
33623-06	6	33625-06
33623-07	7	33625-07
33623-08	8	33625-08

Flachmeißel, Hohlmeißel, Osteotome  
 Chisels, Gouges, Osteotome  
 Cinceles, Gubias, Osteótomo  
 Scalpelli, sgorbie, Osteotomia

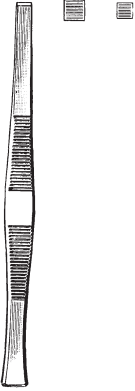

**PASSOW**  
 12 cm, 4 3/4"  
 33626-35 3,5 mm  
 33626-25 2,5 mm



**BRÜNINGS-LUCAS**  
 16 cm, 6 1/4"  
 33627-04 4 mm  
 33627-06 6 mm

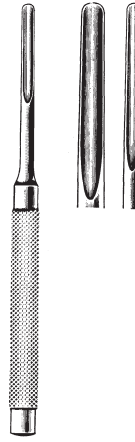

**BRÜNINGS-LUCAS**  
 16 cm, 6 1/4"  
 33628-03 3 mm  
 33628-05 5 mm



**STILLE**  
 20 cm, 8"  
 33630-06 6 mm  
 33630-08 8 mm  
 33630-10 10 mm  
 33630-12 12 mm  
 33630-15 15 mm  
 33630-20 20 mm  
 33630-25 25 mm  
 33630-30 30 mm



**STILLE**  
 20 cm, 8"

	6 mm
	8 mm
33631-10	10 mm
33631-12	12 mm
33631-15	15 mm
33631-20	20 mm
33631-25	25 mm
33631-30	30 mm



**STILLE**  
 20 cm, 8"

33632-06	6 mm
33632-08	8 mm
33632-10	10 mm
33632-12	12 mm
33632-15	15 mm
33632-20	20 mm
33632-25	25 mm
33632-30	30 mm



**STILLE**  
 20 cm, 8"

33633-06	6 mm
33633-08	8 mm
33633-10	10 mm
33633-12	12 mm
33633-15	15 mm
33633-20	20 mm
33633-25	25 mm
33633-30	30 mm



**STILLE**  
 20 cm, 8"

33634-06	6 mm
33634-08	8 mm
33634-10	10 mm
33634-12	12 mm
33634-15	15 mm
33634-20	20 mm
33634-25	25 mm
33634-30	30 mm

Osteotome, Hohlmeißel  
 Osteotome, Gouges  
 Osteótomo, Gubias  
 Osteotomia, sgorbie

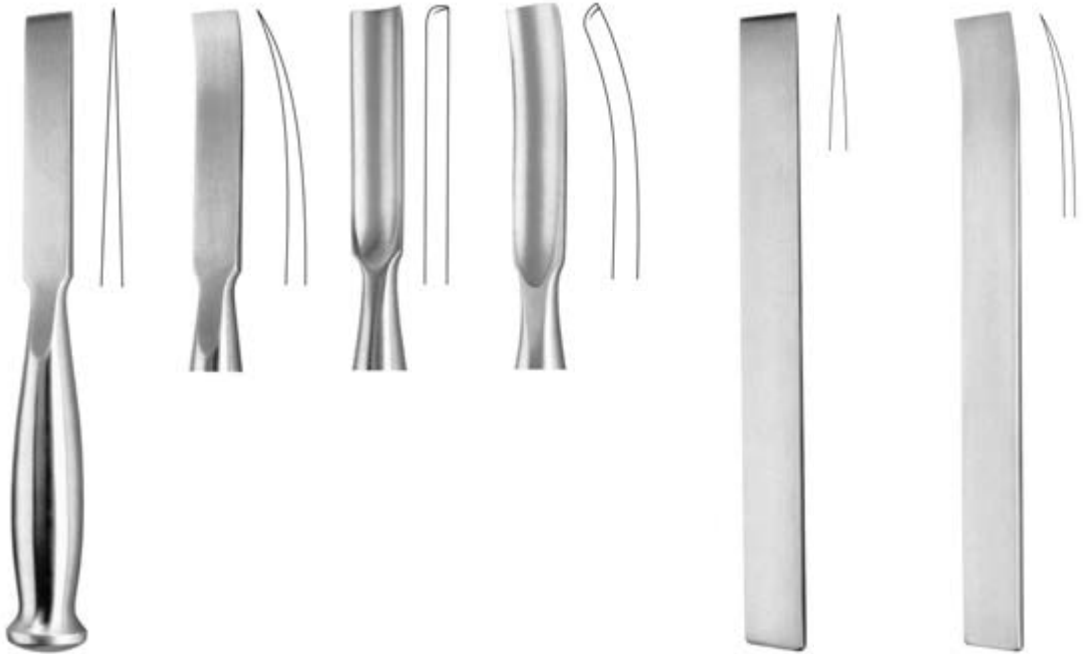

SMITH-PETERSEN  
 20 cm, 8"

LAMBOTTE  
 24 cm, 9 1/2"      23 cm, 9"

6 mm	33644-06	33645-06	33647-06	
9 mm	33644-09	33645-09	33647-09	33649-09
13 mm	33644-13	33645-13		
14 mm			33647-14	33649-14
16 mm	33644-16	33645-16	33647-16	33649-16
19 mm	33644-19	33645-19	33647-19	33649-19
25 mm	33644-25	33645-25	33647-25	33649-25
32 mm	33644-32	33645-32	33647-32	33649-32

33650-04	4 mm	33651-04
33650-06	6 mm	33651-06
33650-08	8 mm	33651-08
33650-10	10 mm	33651-10
33650-13	13 mm	33651-13
33650-16	16 mm	33651-16
33650-18	18 mm	33651-18
33650-20	20 mm	33651-20
33650-25	25 mm	33651-25
33650-30	30 mm	33651-30
33650-38	38 mm	33651-38
33650-44	44 mm	33651-44
33650-50	50 mm	33651-50

Osteotome, Hohlmeißel  
 Osteotome, Chisels, Gouges  
 Osteótomo, Cinceles, Gubias  
 Osteotomia, Scalpelli, sgorbie

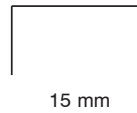
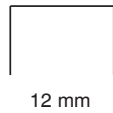
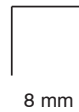

12,5 cm, 5"	mm	17 cm, 6 3/4"
33654-02	2	33652-02
33654-03	3	33652-03
33654-04	4	33652-04
33654-06	6	33652-06
33654-08	8	33652-08
33654-10	10	33652-10
33654-12	12	33652-12
33654-15	15	33652-15

MINI-LAMBOTTE

8 mm



COBB  
 28 cm, 11"  
 33656-28

8 mm



COBB  
 28 cm, 11"  
 33657-28

8 mm



COBB  
 28 cm, 11"  
 33658-28

8 mm



COBB  
 28 cm, 11"  
 33659-28

mit Ferrozellgriff  
 with Ferrozell-Handle  
 con mango de Ferrozell  
 con manico di Ferrozell

Osteotome und Hohlmeißel mit Ferrozell-Griff  
 Osteotome and Gouges with Ferrozell-Handle  
 Osteótomo, Gubias con mango de Ferrozell  
 Osteotomo, con manico di Ferrozell



LEXER  
 22 cm, 8 3/4"

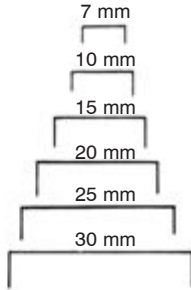

33660-07	7 mm	33661-07
33660-10	10 mm	33661-10
33660-15	15 mm	33661-15
33660-20	20 mm	33661-20
33660-25	25 mm	33661-25
33660-30	30 mm	33661-30

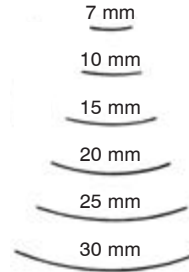

LEXER  
 22 cm, 8 3/4"



LEXER MINI  
 18 cm, 7"

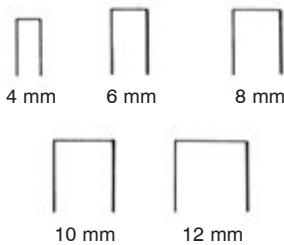

33664-04	4 mm	33665-04
33664-06	6 mm	33665-06
33664-08	8 mm	33665-08
33664-10	10 mm	33665-10
33664-12	12 mm	33665-12

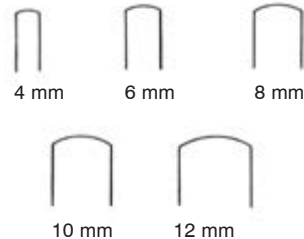

LEXER MINI  
 18 cm, 7"

Flachmeißel, Hohlmeißel  
 Chisels, Gouges  
 Cinceles, Gubias  
 Scalpelli, sgorbie



20 mm



16 mm

mit Ferrozellgriff  
 with Ferrozell-Handle  
 con mango de Ferrozell  
 con manico di Ferrozell

33665-24  
 24,5 cm, 9 3/4"

33665-26  
 26,5 cm, 10 1/2"



9 mm



25 cm, 10"

mit NOVOTEX-Griff  
 with Novotex-Handle  
 con mango de Novotex  
 con manico di Novotex

ZIELKE 23 cm, 9"  
 33665-55 5,5 mm  
 33665-90 9,0 mm

22 cm, 8 3/4"  
 33666-22

33669-05	5 mm	33670-05
33669-10	10 mm	33670-10
33669-15	15 mm	33670-15



Osteotome, Flachmeißel, Hohlmeißel  
 Osteotome, Chisels, Gouges  
 Osteótomo, Cinceles, Gubias  
 Osteotomia, Scalpelli, Sgorbie

**HOKE**

14 cm, 5 1/2"

33668-03	3 mm
33668-05	5 mm
33668-06	6 mm
33668-08	8 mm
33668-09	9 mm
33668-13	13 mm
33668-16	16 mm
33668-19	19 mm

**HIBBS**

24 cm, 9 1/2"

33670-06	6 mm
33670-09	9 mm
33670-13	13 mm
33670-16	16 mm
33670-19	19 mm
33670-25	25 mm
33670-32	32 mm

**HIBBS**

24 cm, 9 1/2"

33671-06	6 mm
33671-09	9 mm
33671-13	13 mm
33671-16	16 mm
33671-19	19 mm
33671-25	25 mm
33671-32	32 mm

**HIBBS**

24 cm, 9 1/2"

33672-06	6 mm
33672-09	9 mm
33672-13	13 mm
33672-16	16 mm
33672-19	19 mm
33672-25	25 mm
33672-32	32 mm

**HIBBS**

24 cm, 9 1/2"

33673-06	6 mm
33673-09	9 mm
33673-13	13 mm
33673-16	16 mm
33673-19	19 mm
33673-25	25 mm
33673-32	32 mm

**HIBBS**

24 cm, 9 1/2"

33675-06	6 mm
33675-09	9 mm
33675-13	13 mm
33675-16	16 mm
33675-19	19 mm
33675-25	25 mm
33675-32	32 mm

Meißel  
Chisels  
Cinceles  
Scalpelli

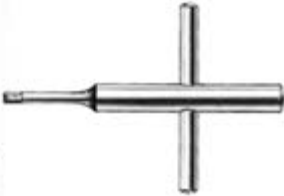

33676-02  
9 cm, 3 1/2"  
Spannschlüssel  
Key  
Llave  
Clé  
Chiave



5 mm  
33676-05  
8,5 mm, 3.4"



10 mm  
33676-10  
8,5 mm, 3.4"



16 mm  
33676-16  
8,5 mm, 3.4"



25 mm  
33676-25  
8,5 mm, 3.4"

Meißelklingen  
auswechselbar  
Chisel blades  
interchangeable  
Hojas de cincel  
intercambiables  
Lame intercambiabili

33676-01  
18,5 cm, 7 1/4"  
Griff allein  
Handle only  
Mango suelto  
Manico solo



5 mm  
33677-05  
8,5 mm, 3.4"



10 mm  
33677-10  
8,5 mm, 3.4"



16 mm  
33677-16  
8,5 mm, 3.4"



25 mm  
33677-25  
8,5 mm, 3.4"

Osteotomklingen  
auswechselbar  
Osteotome blades  
interchangeable  
Hojas de osteótomo  
intercambiables  
Lame per osteotomia  
intercambiabili

Sternummeißel, Osteotom, Schädelspalter, Rachiotom, Muskelhaken  
 Sternum Chisel, Osteotome, Skull breaker, Rachiotome, Muscle hooks  
 Cinceles de esternón, Osteotomo, Cincel rompe-cráneo, Raquiótomos, Ganchos musculare  
 Scalpello per sterno, Osteotomo, Divisore per cranio, Rachiotomi, Uncino per muscoli

23 mm



LEBSCHKE  
 33678-24  
 24,5 cm, 9 3/4"



33679-13  
 13 cm, 5 1/8"



33680-22  
 14 cm, 5 1/2"



33682-22  
 22 cm, 8 3/4"



19902-10  
 10 cm, 4"



19903-00

Medizinlöffel, Meißel, Sektionsnadeln  
 Medicine Spoon, Chisels, Post mortem needles  
 Cuchara graduada, Cinceles, Agujas para autopsia  
 Cucchiario per medicinali, Scalpelli, Aghi per autopsia



89146-20 20 cc  
 110 x 20 mm

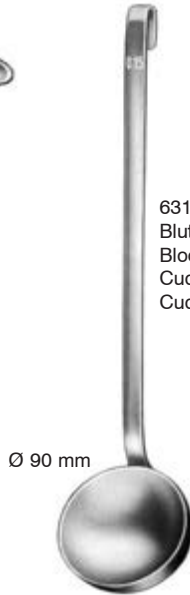

Ø 90 mm

63174-00  
 Blutschöpfer, 150 ccm  
 Blood scoop, 9 cu. inches  
 Cucharra p / sangre  
 Cucchiario per sangue

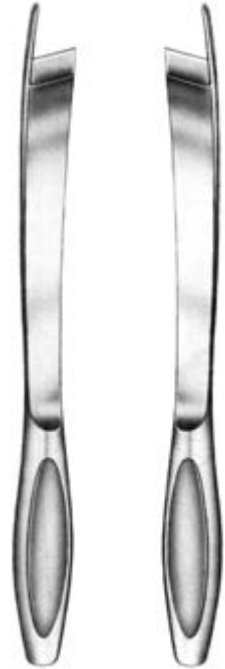

BRUNETTI  
 28,5 cm, 11 1/4"

33682-01	33682-02
links	rechts
left	right
izquierdo	derecho
sinistra	destra

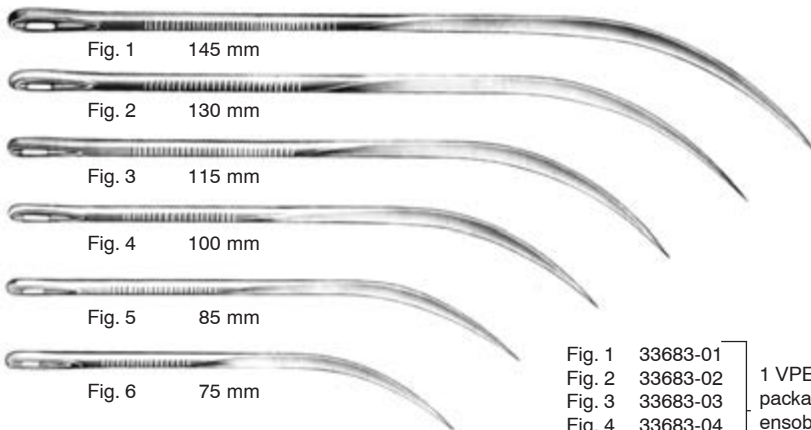

Fig. 1 145 mm

Fig. 2 130 mm

Fig. 3 115 mm

Fig. 4 100 mm

Fig. 5 85 mm

Fig. 6 75 mm

Fig. 1	33683-01	} 1 VPE = 12 Stk. package of 12 ensobres de 12 confezione di 12
Fig. 2	33683-02	
Fig. 3	33683-03	
Fig. 4	33683-04	
Fig. 5	33683-05	
Fig. 6	33683-06	

Obduktionsbesteck  
 Post Mortem Set  
 Estuches para Autopsia  
 Astucci per Autopsia



33684-00

Kleines Besteck, Holzetui, enthaltend:

- 4 Skalpelle
- 1 Knorpelmesser
- 1 Inzisionsschere, 13 cm (5 1/8")
- 1 Anatomische Pinzette, 13 cm (5 1/8")
- 1 Amputationssäge Charrière
- 1 Hammer
- 1 Meißel
- 2 doppelte Muskelhaken
- 2 doppelte Tubuli
- 2 Knopfsonden, 13 cm (5 1/8")
- 3 Wundnadeln

Small set, wooden case, containing:

- 4 Dissecting Knives
- 1 Cartilage Knife
- 1 Incision Scissors, 13 cm (5 1/8")
- 1 Dissecting Forceps, 13 cm (5 1/8")
- 1 Amputation Saw Charrière
- 1 Mallet
- 1 Chisel
- 2 Retractors, double ended
- 2 Blow pipes, double
- 2 Probes, 13 cm (5 1/8")
- 3 Suture Needles

Modelo pequeño, estuche de madera, conteniendo:

- 4 Escalpelos
- 1 Cuchillo para cartilago
- 1 Tijera de incision, 13 cm (5 1/8")
- 1 Pinza para disección, 13 cm (5 1/8")
- 1 Sierra de amputación Charrière
- 1 Martillo
- 1 Escoplo
- 2 Separadores de 2 gárfios, dobles
- 2 Tubos insufladores, dobles
- 2 Estiletos olivares, 13 cm (5 1/8")
- 3 Agujas para sutura

Modelo piccolo, astuccio di legno, composto da:

- 4 Bisturi
- 1 Coltello per cartilagine
- 1 Forbice per incisione, 13 cm (5 1/8")
- 1 Pinza anatomica, 13 cm (5 1/8")
- 1 Sega per amputazione, Charrière
- 1 Martello
- 1 Scalpello
- 2 Divaricatori con 2 ganci, doppi
- 2 Tubi inalatori, doppi
- 2 Specilli bottonuti, doppi, 13 cm (5 1/8")
- 3 Aghi per sutura

Hämmer  
Mallets  
Martillos  
Martelli

Ø 25 mm



GERZOG  
18 cm, 7"  
33686-25 250 g

Ø 38 mm

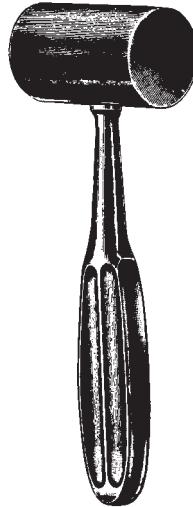

KIRK  
19 cm, 7 1/2"  
33687-75 750 g

Ø 34 mm

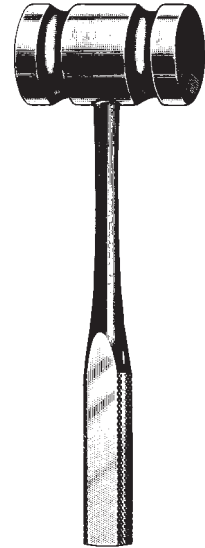

26,5 cm, 10 1/2"  
33688-45 450 g  
33689-90 900 g

Ø 30 mm

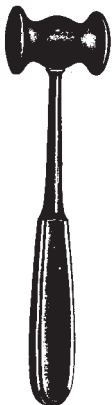

COLLIN  
20 cm, 8"  
33690-22 220 g

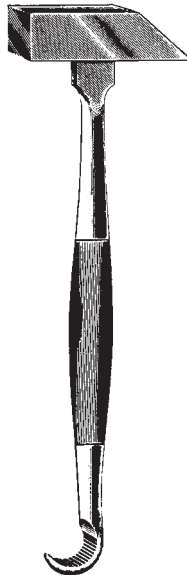

33699-00  
23,5 cm, 9 1/4"  
480 g

Ø 25 mm



33694-01 18,5 cm, 7 1/4"  
33694-03 Ersatzbacken  
Nylon Caps  
Tapas de repuesto  
Placche di ricambio

135 g

Hämmer  
Mallets  
Martillos  
Martelli

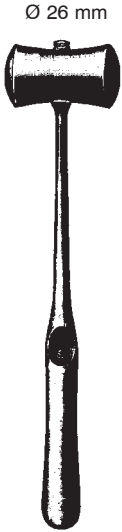

WILLIGER  
24 cm, 9 1/2"  
33691-34 340 g



LUCAE  
19 cm, 7 1/2"  
33692-26 260 g

massiv, mit auswechselbaren Ferrozellbacken  
solid, with interchangeable Ferrozell jaws  
macizo, con tapas intercambiables de Ferrozell  
solido, con placche intercambiabili in Ferrozell



33693-33  
Paar Ersatzbacken  
Pair spare jaws  
par de tapas de repuesto  
Coppia di placche di ricambio

33693-34  
Satz Ringe  
Set rings  
juego de anillos  
Set anelli

MEAD  
17 cm, 6 3/4"  
33693-32 320 g

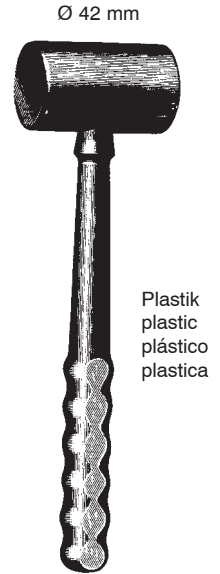

26 cm, 10 1/4"  
33695-40 400 g



QUISLING  
33696-75



PARTSCH  
33698-98  
18 cm, 7"  
199 g



33699-17  
26,5 cm, 10 1/2"  
530 g

Hämmer  
Mallets  
Martillos  
Martelli

Ø 30 mm



33700-01-01  
Ersatzbacken  
Nylon Caps  
Tapas de repuesto  
Placche di ricambio

24,5 cm, 9 3/4" 215 g  
33700-01

Ø 10 mm

Ø 23 mm



Kopf aus Implantatwerkstoff  
Head made of material used for implants  
Cabeza de material de implantación  
Testa in materiale per impianti

23 cm, 9" 350 g  
33700-02

Ø 45 mm



BERGMANN  
24 cm, 9 1/2" 300 g  
33700-03

Ø 30 mm



BERGMANN  
23 cm, 9" 300 g  
33700-04



Hämmer  
Bone Hammers and Mallets  
Martillos y mazos  
Martelli

Ø 30 mm



COTTLE  
18 cm, 7" 240 g  
33700-05

Ø 40 mm



HEATH  
18 cm, 7" 700 g  
33700-06

Ø 40 mm



OMBREDANNE  
25 cm, 10" 700 g  
33700-07

Ø 27 mm



HAJEK  
21 cm, 8 1/4" 140 g  
33700-08

Raspatorien  
 Periosteal  
 Periostótomos  
 Periostotomi

12,5 mm



FARABEU  
 33702-15  
 15 cm, 5.9"

12,5 mm



FARABEU  
 33703-15  
 15 cm, 5.9"

11 mm



FARABEU-COLLIN  
 33704-01  
 15,5 cm, 6"

11 mm

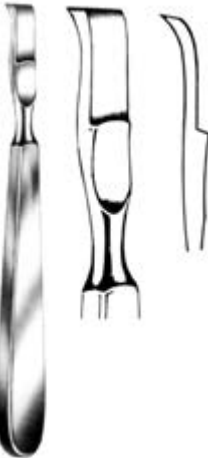

FARABEU-COLLIN  
 33704-02  
 15,5 cm, 6"



LAMBOTTE  
 21 cm, 8 1/4"  
 33705-05 5 mm  
 33705-10 10 mm  
 33705-15 15 mm  
 33705-20 20 mm  
 33705-25 25 mm

18 mm



SEDILLOT  
 18 cm, 7"  
 33706-18

Elevatoren, Raspatorien  
 Elevatoren, Periosteal  
 Elevadores, Periostótomos  
 Elevatori, Periostotomi

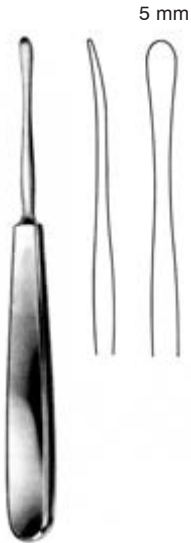

SEBILEAU  
 17,5 cm, 7"  
 33707-17

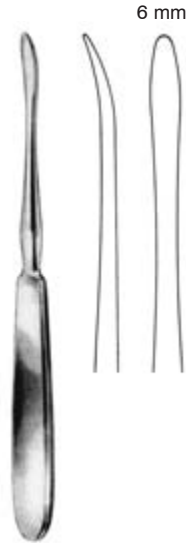

QUERVAIN  
 19,5 cm, 7 3/4"  
 33708-19

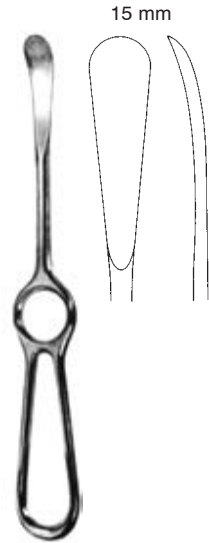

SEDILLOT  
 21 cm, 8 1/4"  
 33709-21



LANGENBECK  
 19 cm, 7 1/2"  
 33710-19



LANGENBECK  
 18 cm, 7"  
 33711-18



LANGENBECK  
 20 cm, 8"  
 33711-20 8 mm  
 33711-21 10 mm

Raspatorien, Elevatoren  
 Raspatories, Elevators  
 Periostótomos, Elevadores  
 Periostotomi, Elevatori

4 mm



WILLIGER  
 33711-16  
 16 cm, 6 1/4"

6,5 mm



WILLIGER  
 33712-16  
 16 cm, 6 1/4"

5 mm



WILLIGER  
 33713-16  
 16 cm, 6 1/4"

5,5 mm



WILLIGER  
 33713-17  
 17 cm, 6 3/4"

5 mm

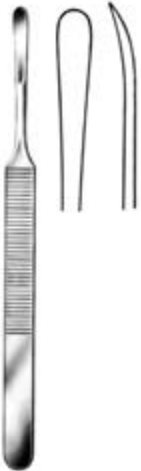

KÖNIG  
 33714-15  
 15,5 cm, 6"

12 mm

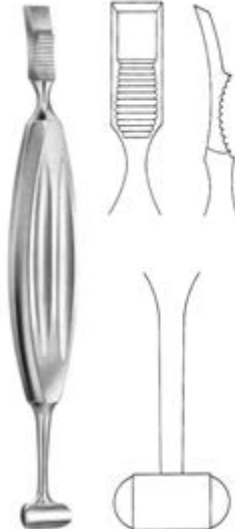

ALEXANDER  
 33715-20  
 21 cm, 8 1/4"



MOLT  
 33716-18  
 18 cm, 7"

Raspatorien, Elevatoren, Saugdissektor  
 Raspatories, Elevators, Suction dissector  
 Periostótomos, Elevadores, Disector con aspirador  
 Periostotomi, Elevatori, Disettore aspiratore



SELDIN  
 33717-19-01  
 19,5 cm 7 3/4"

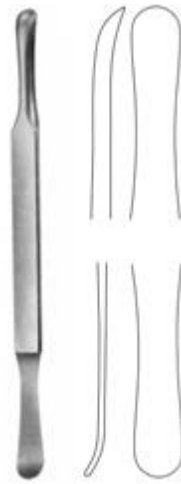

SELDIN  
 33717-19-02  
 19,5 cm 7 3/4"



JOSEPH  
 33718-16  
 16 cm, 6 1/4"



FOMON  
 33719-17  
 17 cm, 6 3/4"



BOIES  
 33720-19  
 19 cm, 7 1/2"



GORNEY  
 33720-21  
 21 cm, 8 1/4"

Raspatorien, Elevatoren  
 Periosteal Elevators  
 Periostótomos, Elevadores  
 Periostotomi, Elevatori

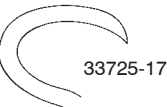
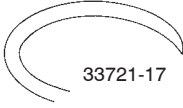

L

DOYEN  
 17 cm, 6 3/4"

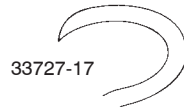
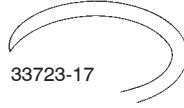

R

DOYEN  
 17 cm, 6 3/4"



33728-24



33729-24

DOYEN  
 24 cm 9 1/2"



SEMB

12 mm



33729-01  
 17,5 cm  
 7"

12 mm



33729-02  
 21 cm  
 8 1/4"

12 mm



33729-03  
 17,5 cm  
 7"

13 mm



33729-04  
 21 cm  
 8 1/4"

15 mm



33729-05  
 20,5 cm  
 8"

15 mm



33729-06  
 20,5 cm  
 8"



33729-07  
 22,5 cm  
 8.9"

Elevatoren, Raspatoren  
Elevators, Raspatories  
Elevadores, Periostótomos  
Elevatori, Periostotomi



MATSON-ALEXANDER  
33731-22  
22 cm, 8 3/4"



MATSON  
33733-22  
22 cm, 8 3/4"



33740-19  
19 cm, 7 1/2"



33741-18  
18,5 cm, 7 1/4"

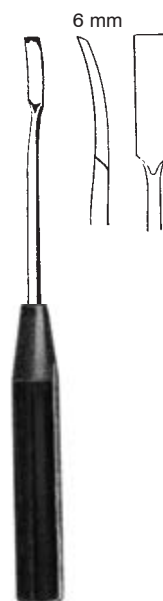

33742-18  
18,5 cm, 7 1/4"



33743-18  
18,5 cm, 7 1/4"

mit Ferrozellgriff  
with Ferrozell-Handle  
con mango de Ferrozell  
con manico di Ferrozell

Elevatoren, Raspatoren  
 Elevators, Raspatories  
 Elevadores, Periostótomos  
 Elevatori, Periostotomi

mit Ferrozellgriff  
 with Ferrozell-Handle  
 con mango de Ferrozell  
 con manico di Ferrozell

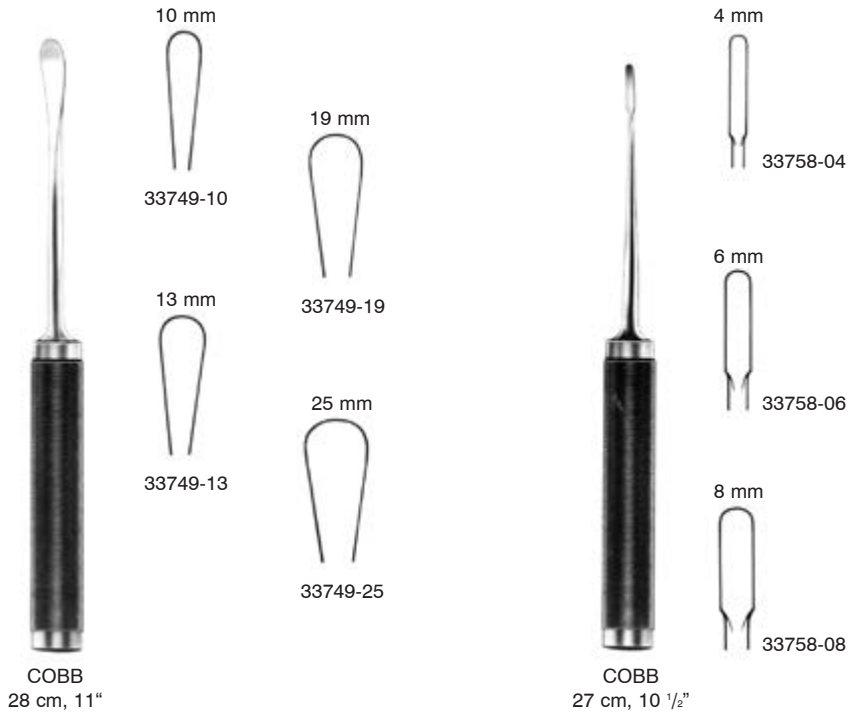
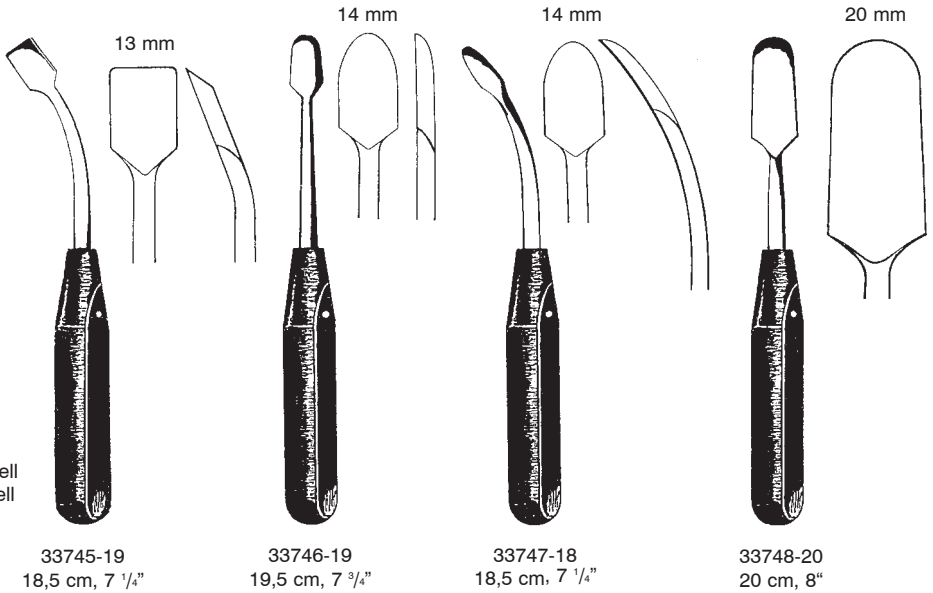



Elevatoren  
Elevators  
Elevadores  
Elevatori

scharf  
sharp  
cortante  
tagliente



SAYRE  
17 cm, 6  $\frac{3}{4}$ "  
33758-01

stumpf  
blunt  
romo  
smusso



SAYRE  
17 cm, 6  $\frac{3}{4}$ "  
33758-02

Raspatoren, Knochenheber, Dissektor  
 Raspatories, Bone Levers, Dissectors  
 Periostótomes para huesos, Disectores  
 Periostotomi, Elevatori per ossa, Dissettori

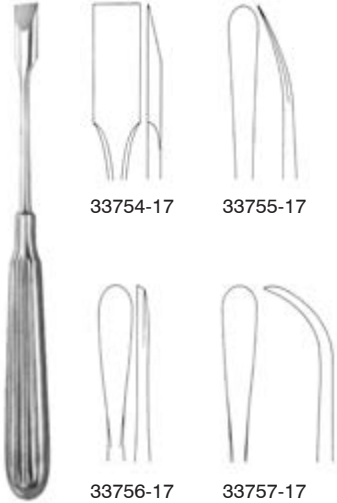

33754-17

33755-17

33756-17

33757-17

ADSON  
 17 cm, 6 3/4"

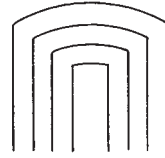

- 33759-06 6 mm
- 33759-12 12 mm
- 33759-19 19 mm
- 33759-25 25 mm

KEY

33759-06 - 33759-25  
 19 cm, 7 1/2"



CHANDLER

- 33763-01 19,0 cm 7 1/2"
- 33763-02 20,3 cm 8"
- 33763-03 22,9 cm 9"
- 33763-04 25,4 cm 10"

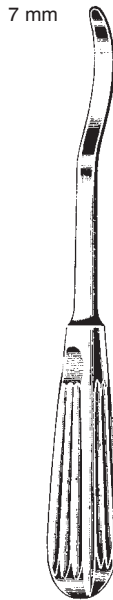

CREGO

33760-01  
 20 cm, 8"



33760-02

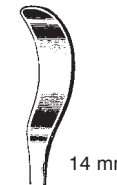

33760-03

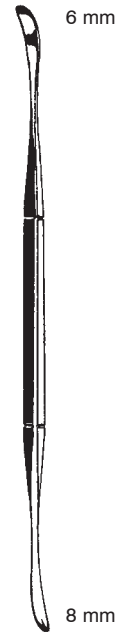

ALDERDYCE

33761-21  
 21 cm, 8 1/4"

Elevatoren, Dissektor, Knochenhebel  
 Elevators, Dissectors, Bone Levers  
 Elevadores para huesos, Disectores  
 Elevatori, Dissettori, Elevatori per ossa

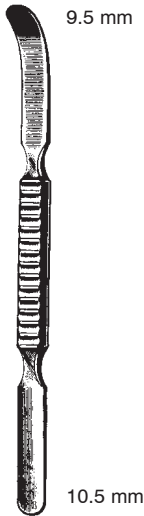

WATSON-CHEYNE  
 33765-17  
 17,5 cm, 7"

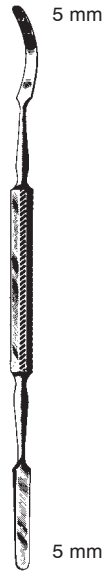

MC DONALD  
 33767-19  
 19 cm, 7 1/2"



MURPHY-LANE  
 33769-30  
 30 cm, 11 3/4"



BENNETT  
 33771-71  
 26 cm, 10 1/4"



BENNETT  
 33771-73  
 26 cm, 10 1/4"

Knochenhebel  
Bone Levers  
Elevadores para huesos  
Elevatori per ossa

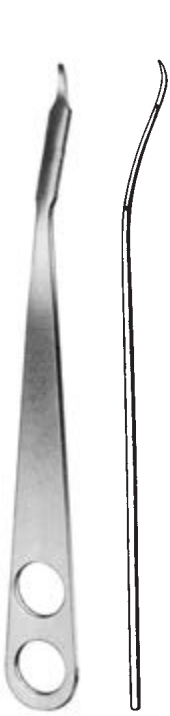

HOHMANN  
33801-08 8 mm  
33801-12 12 mm

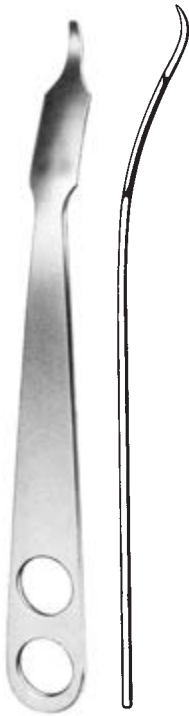

HOHMANN  
33801-18  
18 mm, 3/4"

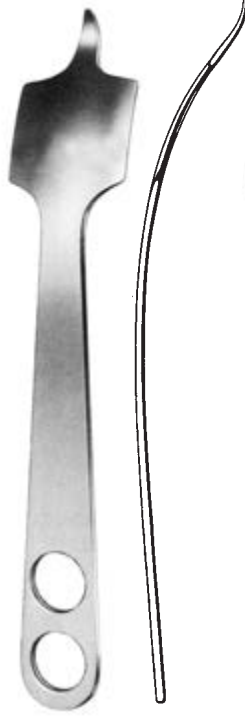

HOHMANN  
33801-43  
43 mm, 1 3/4"



HOHMANN  
33801-70  
70 mm, 2 3/4"

4,5 mm



KÖNIG  
33802-01  
15 cm, 6"

4,5 mm



KÖNIG  
33802-02  
15 cm, 6"

2,8 mm



33802-14  
14 cm, 5 1/2"

5 mm



33803-05  
15 cm, 6"

7 mm



33803-07  
15 cm, 6"

Knochenhebel  
Bone Levers  
Elevadores para huesos  
Elevatori per ossa



HOHMANN  
33803-43 43 mm

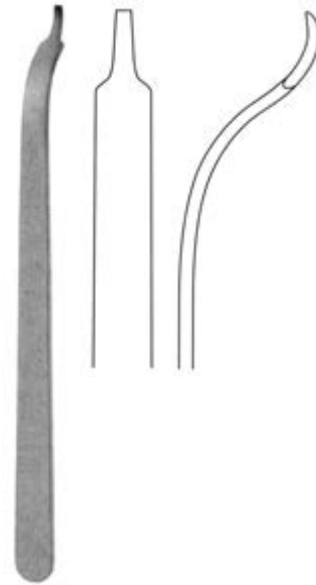

BUCK-GRAMCKO  
33804-15 7,5 mm



HOHMANN  
33805-22 22 mm



HOHMANN  
33805-33 33 mm



HOHMANN  
33807-24 24 mm



HOHMANN  
33809-22 22 mm

Knochenhebel  
 Bone Levers  
 Elevadores para huesos  
 Elevatori per ossa

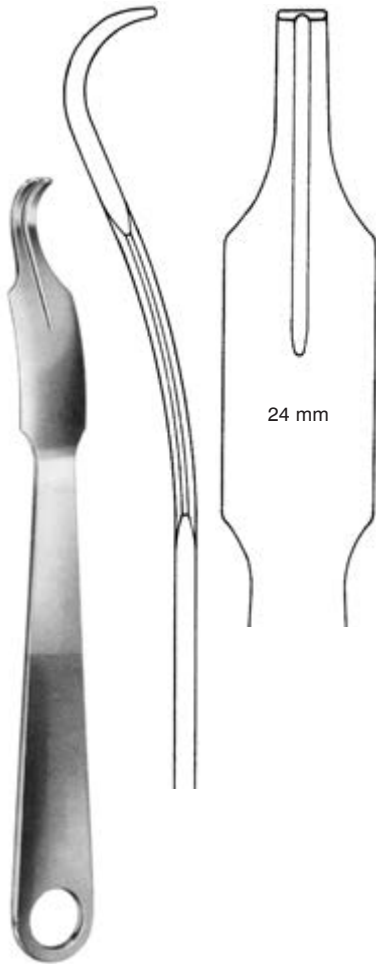

LANGE-HOHMANN  
 33810-24  
 25 cm, 10"



HOHMANN mini  
 16 cm, 6 1/4"

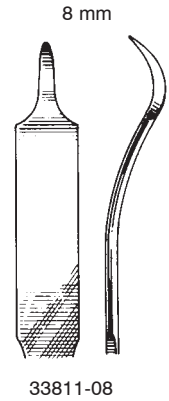
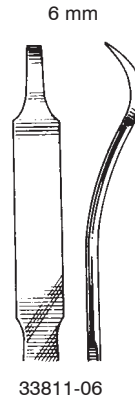

Knochenhebel  
Bone Levers  
Elevadores para huesos  
Elevatori per ossa

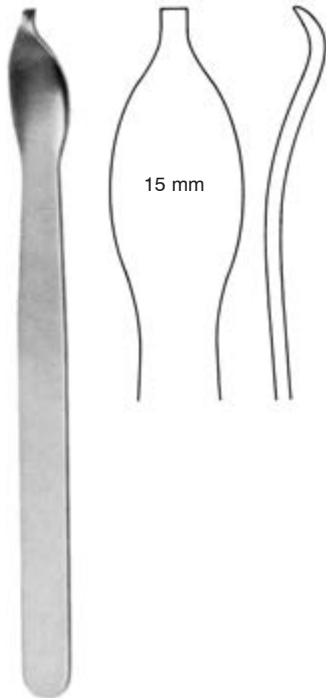

33812-16  
16 cm, 6 1/4"

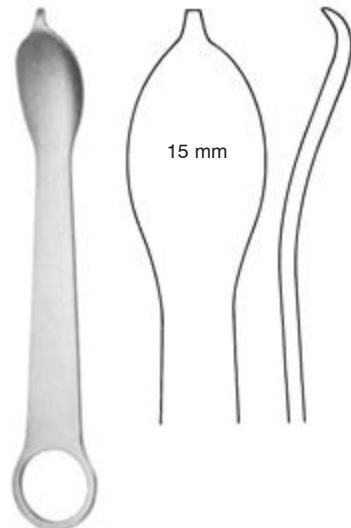

33813-12  
12 cm, 4 3/4"

Knochenheber  
Bone Levers  
Elevadores para huesos  
Elevatori per ossa

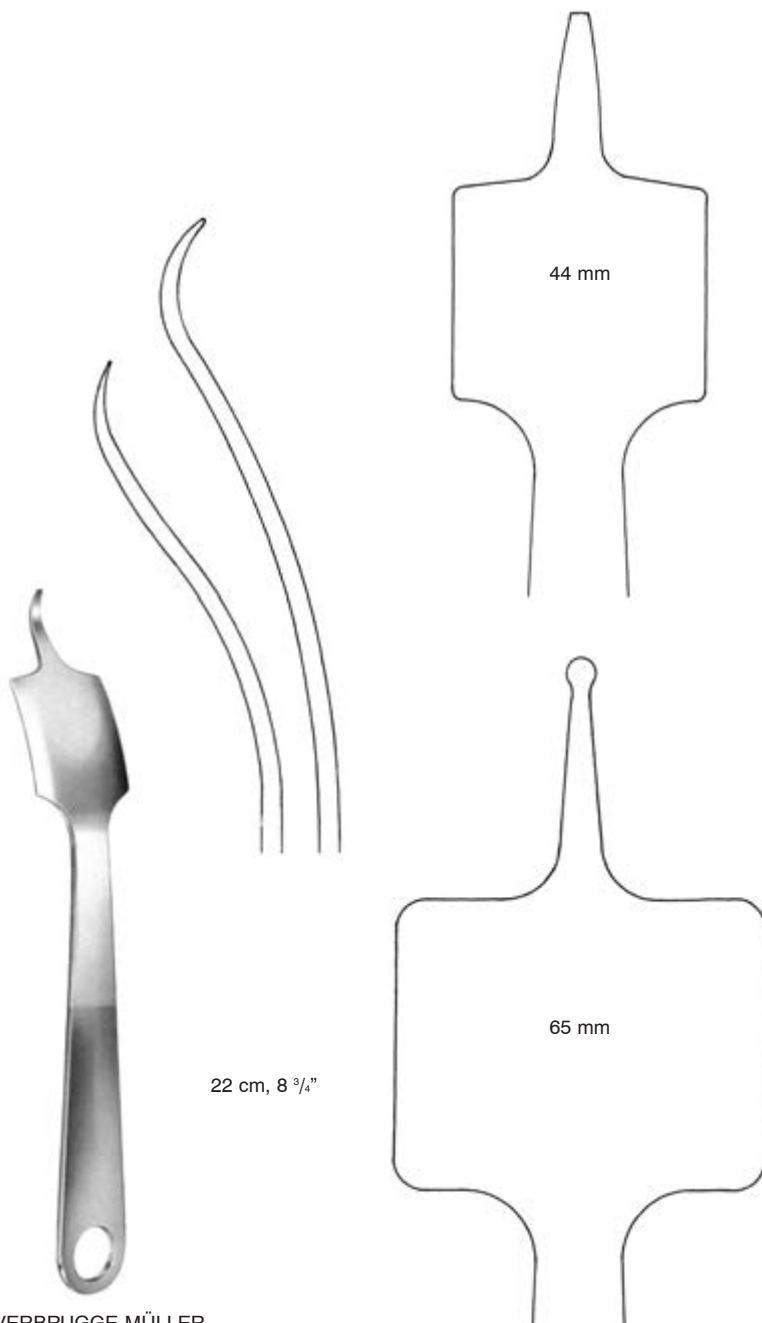

VERBRUGGE-MÜLLER  
33814-44 24,0 cm, 9 1/2"  
33814-65 25,5 cm, 10"





Knochenhebel  
Bone Levers  
Elevadores para huesos  
Elevatori per ossa



BLOUNT  
33823-26  
26 cm, 10 1/4"



BLOUNT  
33825-26  
26 cm, 10 1/4"

Retraktor, Knochenheber, Meniskushaken  
 Retractor, Bone Levers, Meniscus Retractors  
 Separador, Elevadores p. huesos, Separadores para menisco  
 Divaricatori, Elevatori per ossa, Divaricatori per il menisco

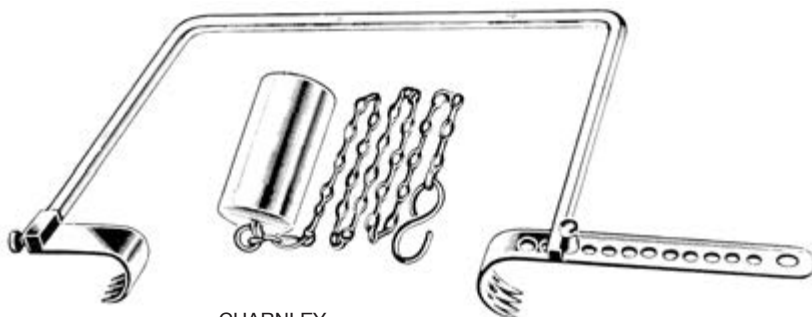

CHARNLEY  
 33826-00

33826-01 spitz, gerieft  
 pointed tip, serrated  
 punta aguda, dentada  
 punta acuta, zigrinata

33826-02 stumpf, gerieft  
 blunt tip, serrated  
 punta roma, dentada  
 punta smussa, zigrinata

33826-03 stumpf, glatt  
 blunt tip, smooth  
 punta roma, lisa  
 punta smussa, liscia



AUFRANC-COBRA  
 26 cm 10 1/4"



BLOUNT  
 33827-17  
 17,5 cm 7"

Knochenhebel  
Bone Levers  
Elevadores p. huesos  
Elevatori per ossa



LANE TRETOWAN  
33828-21  
21,5 cm 8 1/2"



LANE  
33829-25  
25,5 cm 10"



BRISTOW  
33830-23  
23 cm 9"

Knochenheber, Meniskushaken  
 Bone Levers, Meniscus Retractors  
 Elevadores p. huesos, Separadores para menisco  
 Elevatori per ossa, Divaricatori per il menisco



TAYLOR  
 16,5 cm, 6 1/2"  
 33831-16 75x30 mm  
 33833-16 100x30 mm



SMILLIE  
 14 cm, 5 1/2"  
 12 x 13 mm  
 33832-01



SMILLIE  
 14 cm, 5 1/2"  
 52 x 13 mm  
 33832-02



32 x 19 mm  
 33832-03

48 x 19 mm  
 33832-04

57 x 19 mm  
 33832-05

SMILLIE  
 14 cm, 5 1/2"

Sehenschäler, Sehnenfaßpinzette, Sehnenhaltezange, Sehnenfaßinstrumente  
 Tendon seizing instruments  
 Instrumentos para coger tendones  
 Enucleatore di tendine, Strumenti per afferrare tendini



SMILLIE  
 33910-17  
 17 cm, 6 3/4"





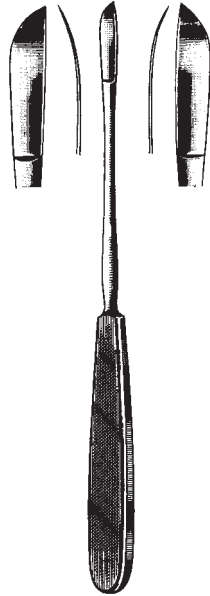

33911-17 17 cm 6 3/4"  
 33913-17 17 cm 6 3/4"



NEFF  
 33921-22 - 33923-22  
 22 cm, 8 3/4"











BUNELL  
 33950-01 - 33950-05  
 15 cm, 6"

-  33950-01 3 mm
-  33950-02 4 mm
-  33950-03 5 mm
-  33950-04 6 mm
-  33950-05 7 mm



LARSEN  
 33960-15 - 33960-55  
 10 cm, 4"

-  
-  33960-15 1,5 mm
-  33960-25 2,5 mm
-  
-  33960-45 4,5 mm
-  33960-55 5,5 mm



JACKSON  
 33961-15  
 15 cm, 6"

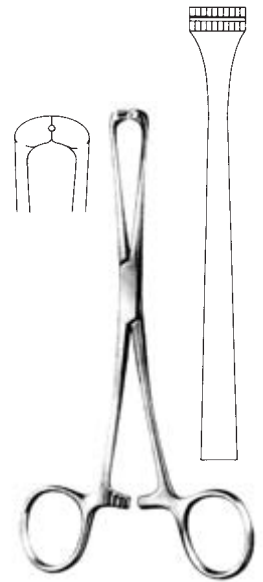

STEINMANN  
 33962-16  
 16 cm, 6 1/4"

Sehnenfaßinstrumente, Sehnenführer  
 Tendon seizing instruments, Tendon passing instr.  
 Instrumentos para coger tendones, Instrumento p. el tunel del tendon  
 Strumenti per afferrare tendini



33963-12  
 12 cm, 4 3/4"



BRAND  
 33964-15 - 33964-24



33964-15  
 15 cm, 6"



33964-19  
 19 cm, 7 1/2"



33964-24  
 24 cm, 9 1/2"



BRAND  
 33965-15 15 cm, 6"  
 33965-19 19 cm, 7 1/2"  
 33965-24 24 cm, 9 1/2"



CAROLL  
 33966-11  
 11 cm, 4 3/8"

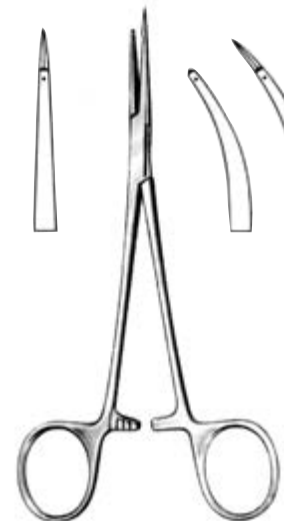

33966-15 15 cm, 6" 33967-15

Sehnenfassinstrumente, Sehnenstripper, Knochenfeilen, Raspeln  
 Tendon seizing instruments, Tendon Strippers, Bone Files, Rasps  
 Instrumentos para coger tendones, Enucleadores de tendones, Limas, Escofinas  
 Strumenti per afferrare tendini, Scollatendini, Lime per ossa, Raspe



KLEINERT-KUTZ  
 33967-20  
 20 cm, 8"

ø 2 mm



BRAND

ø 3 mm



33968-30  
 30 cm, 11 3/4"

ø 6 mm



33968-60  
 50 cm, 19 1/2"



biegsam  
 malleable  
 maleable  
 malleabile

BUNELL

33969-18 18 cm, 7"  
 33969-23 23 cm, 9"



biegsamer Schaft  
 flexible shaft  
 vastago maleabile  
 camicia flessibile

BUNELL 23 cm

33970-01 ø 4,0 mm  
 33970-02 ø 4,5 mm  
 33970-03 ø 5,5 mm



33971-24  
 24,5 cm, 9 3/4"



33972-22  
 22 cm, 8 3/4"

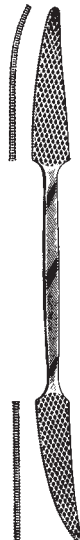

PUTTI  
 33973-27  
 27 cm, 10 1/2"



PUTTI  
 33975-30  
 30 cm, 11 3/4"



33977-28  
 28 cm, 11"

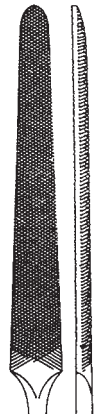



Komprimeter  
 Pneumatic Tourniquet  
 Torniquete pneumático  
 Apparecchio di compressione



34101-01  
compl.

Gerät zur Erzeugung von Blutleere in den Gliedmaßen  
 Compression Apparatus for producing blood vacuum in limbs  
 Aparato de compresión para producir el vacío de sangre en los miembros  
 Vacuometro per determinare vuoti di sangue nelle membra

34101-02

Pumpe  
 Air Pump  
 Bomba de aire  
 Pompa di aria

34101-03

Manometer  
 Manometer  
 Manómetro  
 Manometro

34101-04

Oberarmmanschette  
 Cuff for upper arm  
 Brazalete (brazo)  
 Bracciale  
 34101-06 incl.

34101-05

Oberschenkelmanschette  
 Cuff (leg)  
 Brazalete (pierna)  
 Cosciale  
 34101-07 incl.

34101-06

Polster für Oberarmmanschette 46 x 6 cm (18" x 2.4")  
 Bandage cuff for arm 46 x 6 cm (18" x 2.4")  
 Colchon para brazalete para brazo 46 x 6 cm (18" x 2.4")  
 Bracciale per braccio superiore 46 x 6 cm (18" x 2.4")

34101-07

Polster für Oberschenkelmanschette 55 x 10 cm (21 1/2 x 10")  
 Bandage cuff for leg 55 x 10 cm (21 1/2 x 10")  
 Colchon para brazalete para el femur 55 x 10 cm (21 1/2 x 10")  
 Bracciale per coscia superiore 55 x 10 cm (21 1/2 x 10")

Amputations- und Resektionssägen  
 Amputation and Resection Saws  
 Sierras para amputación y resección  
 Seghe per amputazione e resezione

Staubinde  
 Compression bandage  
 Vendaje de compresión  
 Benda per compressione  
 5 m lang / long  
 6 cm breit / wide



ESMARCH  
 34105-01

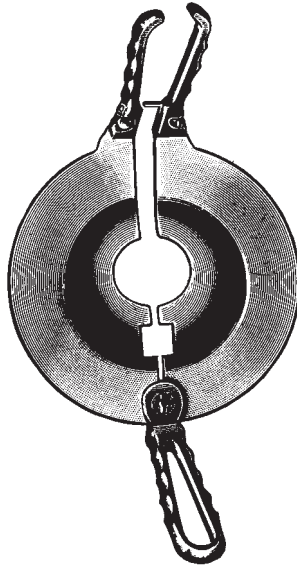

PERCY  
 34110-00



CHARRIERE  
 34112-00  
 35 cm, 13 3/4"

34112-01  
 12 mm

Ersatzsägeblätter  
 Spare saw blades  
 Hojas de sierra de  
 repuesto  
 Lame di ricambio

34112-02  
 15 mm

Ersatzsägeblätter  
 Spare saw blades  
 Hojas de sierra de  
 repuesto  
 Lame di ricambio

komplett mit 2 Blättern  
 complete with 2 blades  
 completo con 2 hojas  
 completa con 2 lame



mit 3 Sägeblätter  
 4 - 6 - 8 mm  
 with 3 spare blade  
 con 3 hojas de repuesto  
 con 3 lame di ricambio

BIER  
 34114-39  
 40,5 cm, 16"



CHARRIERE  
 34116-30  
 30 cm, 11 3/4"

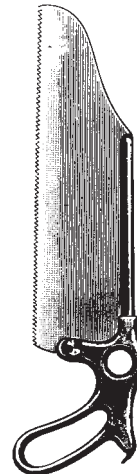

SATTERLEE  
 34118-31  
 31 cm, 12 1/4"

34118-99  
 Sägeblatt  
 blade  
 hoja  
 lama



LANGENBECK  
 34120-23  
 23 cm, 9"

Nagelausreibzange, Fingerringsägen  
 Fcps. f. tearing out finger nails, Finger Ring Saws  
 Pinzas para arrancar uñas, Sierras para abrir anillos  
 Pinze per lacerazione delle unghie, Seghe per anelli

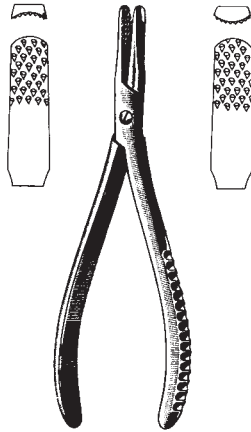

RADOLF

- 34161-13 13,5 cm, 5 1/4" 3 mm
- 34162-13 13,5 cm, 5 1/4" 6 mm

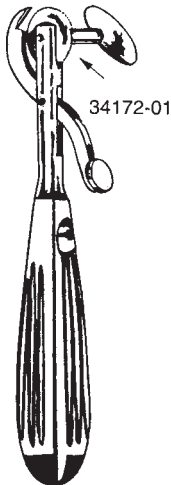

WALTON  
 34172-00  
 16 cm, 6 1/4"

Sägeblatt  
 Saw blade  
 Hoja de sierra  
 Lama di ricambio

34172-01



REDA  
 34175-00  
 17 cm, 6 3/4"

Sägeblatt  
 Saw blade  
 Hoja de sierra  
 Lama di ricambio

34175-01

Bohrapparate, Bohrlochzange  
 Bone Hand Drills, Forceps for Bone Hole  
 Perforador de mano, Pinza de guía  
 Perforatori a mano, Pinza per perforazione

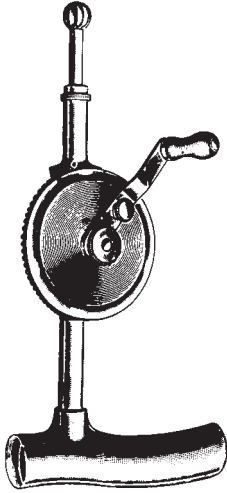

**STILLE**  
 34210-20 20 cm, 8"  
 compl. incl. 34212-25 - 34214-16

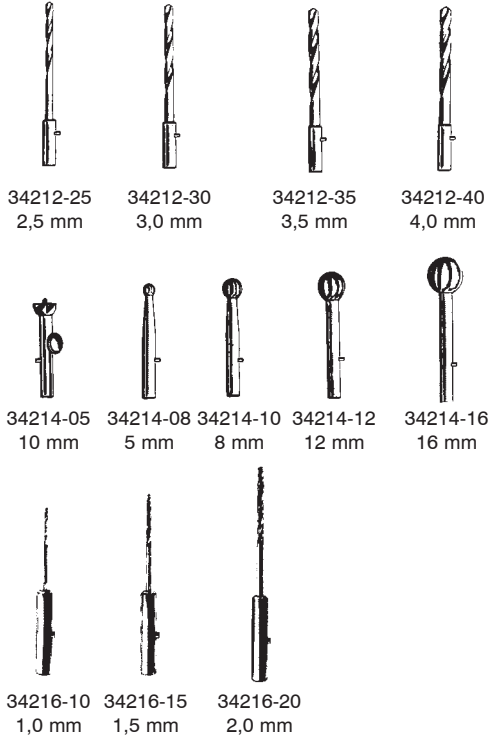

34212-25 2,5 mm    34212-30 3,0 mm    34212-35 3,5 mm    34212-40 4,0 mm

34214-05 10 mm    34214-08 5 mm    34214-10 8 mm    34214-12 12 mm    34214-16 16 mm

34216-10 1,0 mm    34216-15 1,5 mm    34216-20 2,0 mm

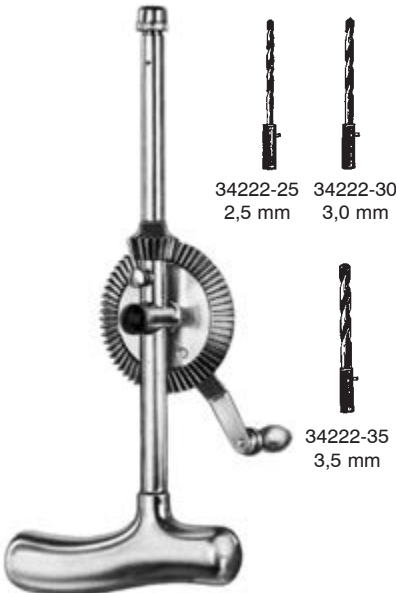

**STILLE-SHERMAN**  
 34220-24 24 cm, 9 1/2"  
 compl. incl. 34222-25 - 34222-35

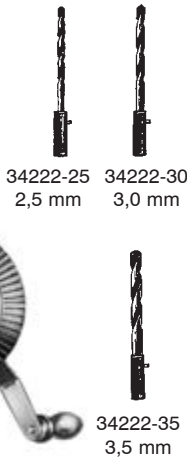

34222-25 2,5 mm    34222-30 3,0 mm

34222-35 3,5 mm



**MOORE**  
 34230-28 28 cm, 11"  
 compl. incl. 34232-00



34232-00  
 Ø 3,2 mm

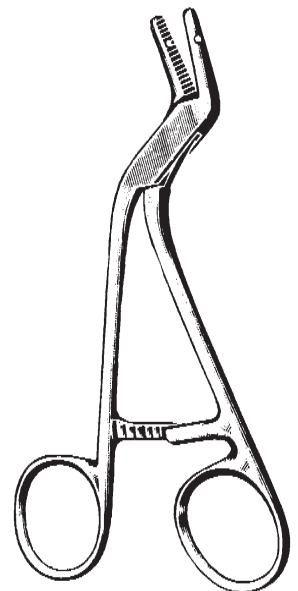

**ADSON**  
 34231-15  
 15 cm, 6"

Bohrapparate  
 Bone Hand Drills  
 Perforador de mano  
 Perforatori a mano



34241-00  
 Griff allein  
 Handle only  
 Mango solo  
 Manico solo

HUDSON

34240-27 27 cm, 10 1/2"  
 compl. incl. 34242-09, -14, -16, -22,  
 34246-00



34242-09  
 9 mm



34242-14  
 14 mm



34242-16  
 16 mm



34242-22  
 22 mm



ø 2 mm  
 34243-02



CUSHING  
 34244-10  
 34244-14  
 34244-16



ERRICO  
 34244-17  
 ø 16 mm



MC KENZIE  
 34248-00  
 ø 13 mm



34246-00  
 Verlängerungsstück  
 Extension piece  
 Pieza alargadera  
 Giunto di prolungamento



KIRSCHNER  
 34250-00 compl.



34252-00



BUNELL  
 34270-00 16 cm, 6 1/4"

34270-01  
 Schlüssel  
 Wrench  
 Llave  
 Chiave

Bohrapparat 16 cm (6 1/4"), längsdurchbohrt mit Dreibackenspannfutter und Schlüssel, Spannweite bis 4 mm  
 Hand drill, 16 cm (6 1/4"), longitudinally bored, with three-jaw-chuck and key, opening up to 4 mm

Perforador manual, 16 cm (6 1/4"), taladrado longitudinalmente, con mandril de tres mordazas y llave, abriendo hasta 4 mm  
 Perforatore a mano, 16 cm (6 1/4"), con perforazione assiale, con mandrino a tre ganasce e chiave, apertura fino a 4 mm di D.

Bohrapparate, Handgriffe  
 Bone Hand Drills, Handles  
 Perforador de mano  
 Perforatori a mano, manici



RALK  
34280-00



REDA  
34290-00



34295-00



34296-00

Spannschlüssel allein  
 Key only  
 Llave suelta  
 Chiave solo

Handgriff mit Jacobs-  
 spannfutter und Spann-  
 schlüssel bis 3,6 mm  
 Handle with Jacobs chuck  
 and key to 3,6 mm  
 Mango con cierre Jacobs,  
 de 3 mordazas y llave a  
 3,6 mm  
 Manico con mandrino di  
 Jacobs e chiave a 3,6 mm

Bohrapparat mit Leichtmetallgehäuse, mit Dreibackenspannfutter und Schlüssel, Spannweite bis D. 6,35 mm  
 Hand drill with light metal case, with three-jaw-chuck and key, opening up to D. 6,35 mm  
 Perforador manual con caja de aluminio, con mandril de tres mordazas y llave, abriendo hasta 6,35 mm de D.  
 Perforatore a mano con cassa in metallo leggero, con mandrino a tre ganasce e chiave, apertura fino a 6,35 mm di D.

Handbohrapparat mit umstellbarem Handgriff, mit Jacobs Dreibackenspannfutter und Schlüssel  
 Hand drill with adjustable handle, with Jacobs three-jaw-chuck and wrench  
 Perforador de mano en T con cierre Jacobs de 3 mordazas y llave de ajuste  
 Perforatore a mano con manico regolabile, con mandrino a tre ganasce di Jacobs e chiave



34296-05

T-Handgriff, verriegelbares schlüsselloses Dreibackenspannfutter, rostfrei  
 T-handle, keyless locking chuck  
 Mango en T, mordaza sin llave, inox.  
 Chiave a T con mandrino a tre ganasce inox



34296-10

Handgriff, Dreibackenspannfutter, inkl. Spannschlüssel rostfrei  
 Handle with chuck, including key  
 Mango, mordaza incluyendo llave, inox.  
 Mandrino a tre ganasce con manico recto completo di chiave di arresto inox



34296-15

"Hudson" T-Handgriff, Schnellkupplung  
 Hudson T-handle with fast gripping chuck  
 Mango en T, acople rápido  
 Hudson: mandrino con manico a T  
 Ganasce con raccordo rapido



34296-20

Schnellkupplungs T-Handgriff, groß  
 T-handle with fast gripping chuck, large  
 Mango en T, acople rápido, grande  
 Mandrino a T manico grande  
 Raccordo rapido

Schnellkupplungs-Handgriffe  
Handles with quick-action chuck  
Mangos de acople rápido  
Manici con attachi rapidi



34296-25  
Schnellkupplungs-T-Handgriff  
T-Handle, quick-action  
Mango en T, acople rápido  
Mandrino a T con raccordo rapido



34296-30  
Schnellkupplungs-Handgriff  
groß mit Hartgewebegriff  
Handle, quick-action, large,  
handle made of very hard fibre  
Mango de acople rápido,  
grande, de material extraduro  
Mandrino grande rapido con  
manico a fibre dure



34296-35  
Schnellkupplungs-Handgriff  
mit Hartgewebegriff  
Handle, quick-action,  
made of very hard fibre  
Mango de acople rápido,  
de material extra-duro  
Mandrino medio rapido con  
manico a fibre dure



34296-40  
Mini Schnellkupplungs-Handgriff  
für „Dental“-Anschluß  
Mini-Handle, quick-action,  
"dental"  
Mini-Mango de acople rápido  
"dental"  
Mini mandrino-rapido con  
impugnatura cilindrica con  
attacco dentale

Bohrer  
Drill bits  
Taladros  
Perforatore



Ø		
1,0 mm	56 mm	34320-10
1,5 mm	70 mm	34320-15
2,0 mm	85 mm	34320-20
2,5 mm	95 mm	34320-25
2,7 mm	100 mm	34320-27
3,0 mm	100 mm	34320-30
3,2 mm	106 mm	34320-32
3,5 mm	112 mm	34320-35
4,0 mm	119 mm	34320-40
4,5 mm	126 mm	34320-45
5,0 mm	132 mm	34320-50
6,0 mm	139 mm	34320-60
7,0 mm	156 mm	34320-70

Spiralbohrer mit Glattschaft  
Twist Drills with round end  
Taladros espirales con vástago redondo  
Perforatore elicoidale



Ø		
1,0 mm	180 mm	34321-10
1,5 mm	180 mm	34321-15
2,0 mm	180 mm	34321-20
2,5 mm	180 mm	34321-25
2,7 mm	180 mm	34321-27
3,0 mm	180 mm	34321-30
3,2 mm	180 mm	34321-32
3,5 mm	180 mm	34321-35
4,0 mm	180 mm	34321-40
4,5 mm	180 mm	34321-45
5,0 mm	180 mm	34321-50
6,0 mm	180 mm	34321-60
6,5 mm	180 mm	34321-65
7,0 mm	180 mm	34321-70
8,0 mm	180 mm	34321-80
9,0 mm	180 mm	34321-90
10,0 mm	180 mm	34322-00

Spiralbohrer mit Glattschaft langes Modell  
Twist Drills, long typ  
Taladros espirales, largos  
Perforatore elicoidale, modello lungo



Ø		
1,1 mm	60 mm	34322-11
1,5 mm	85 mm	34322-15
2,0 mm	100 mm	34322-20
2,5 mm	110 mm	34322-25
2,7 mm	100 mm	34322-27
3,2 mm	145 mm	34322-32
3,5 mm	110 mm	34322-35
4,5 mm	145 mm	34322-45

Spiralbohrer mit Schnellkupplungs-Ansatz  
Twist Drills, quick-action  
Taladros espirales, acople rápido  
Perforatore elicoidale con attacco rapido





Pfrieme, Reibahle  
 Awl, Reamer  
 Escariadores  
 Lesine, Punteruoli



34392-14  
 14 cm, 5 1/2"



PERTHES  
 34393-18  
 18 cm, 7"

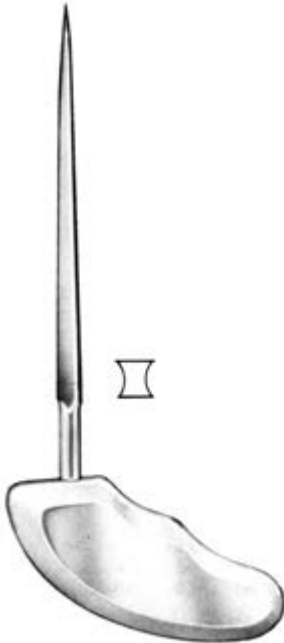

PERTHES  
 34393-21  
 21 cm, 8 1/4"

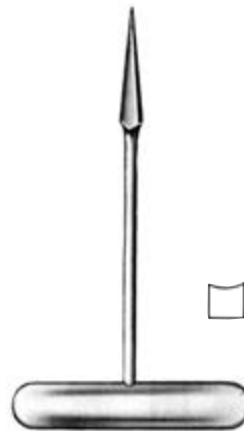

34394-14  
 14 cm, 5 1/2"

Faßpinzette, Bohrdrahtspender  
Grasping forceps, Support for sterilisation  
Pinzas para coger, Soporte de esterilización  
Pinze per afferrare, Supporto per la sterilizzazione



34439-00

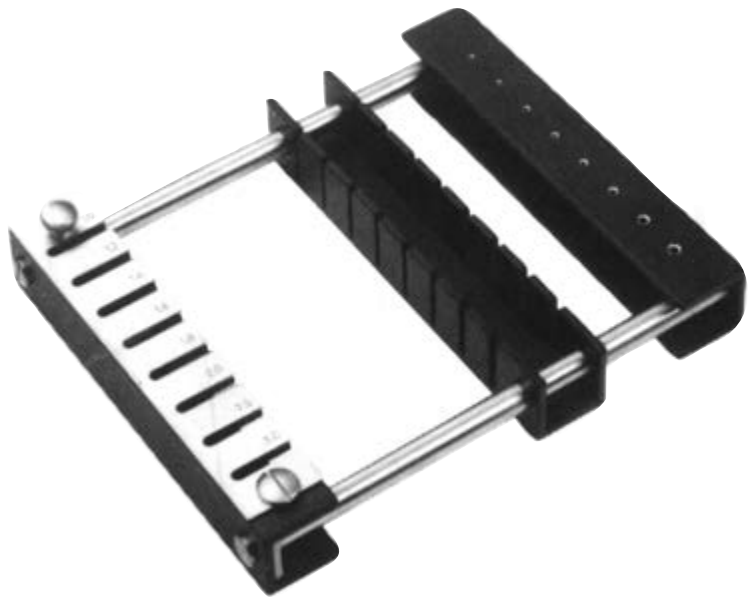

Bohrdrahtspender für Kirschner-Drähte  
Support for sterilisation of Kirschner wires  
Soporte de esterilización p. alambres de Kirschner  
Supporto per la sterilizzazione dei fili di Kirschner

34440-01 bis 15 cm – up to 15 cm (6") – hasta 15 cm – fino a 15 cm  
34440-02 bis 31 cm – up to 31 cm (12 1/4") – hasta 31 cm – fino a 31 cm  
34440-03 bis 10 cm – up to 10 cm (4") – hasta 10 cm – fino a 10 cm

Bohrdrähte  
Drill Wires  
Alambres  
Perforatori filiformi

lieferbar in Packungen à 10 Stück  
available in packages of 10 pieces  
disponible en paquets de 10 unidades  
disponibili solo in confezioni da 10 pezzi

Trokarspitze / Trocar point  
Punta trocar / Punte trequarti

Ø	10 cm, 4"	15 cm, 6"	31 cm, 12 1/4"
0,8	34401-08	34402-08	34403-08
1,0	34401-10	34402-10	34403-10
1,1	34401-11	34402-11	34403-11
1,2	34401-12	34402-12	34403-12
1,3	34401-13	34402-13	34403-13
1,4	34401-14	34402-14	34403-14
1,5	34401-15	34402-15	34403-15
1,6	34401-16	34402-16	34403-16
1,7	34401-17	34402-17	34403-17
1,8	34401-18	34402-18	34403-18
1,9	34401-19	34402-19	34403-19
2,0	34401-20	34402-20	34403-20
2,2	34401-22	34402-22	34403-22
2,3	34401-23	34402-23	34403-23
2,4	34401-24	34402-24	34403-24
2,5	34401-25	34402-25	34403-25
2,8	34401-28	34402-28	34403-28
3,0	34401-30	34402-30	34403-30

Kirschner  
mit rundem Ende / with round shaft  
con extremo redondo / con extremo rotondo

Trokarspitze / Trocar point  
Punta trocar / Punte trequarti

Ø	10 cm, 4"	15 cm, 6"	31 cm, 12 1/4"
0,8	34404-08	34405-08	34406-08
0,9	34404-09	34405-09	34406-09
1,0	34404-10	34405-10	34406-10
1,1	34404-11	34405-11	34406-11
1,2	34404-12	34405-12	34406-12
1,3	34404-13	34405-13	34406-13
1,4	34404-14	34405-14	34406-14
1,5	34404-15	34405-15	34406-15
1,6	34404-16	34405-16	34406-16
1,7	34404-17	34405-17	34406-17
1,8	34404-18	34405-18	34406-18
1,9	34404-19	34405-19	34406-19
2,0	34404-20	34405-20	34406-20
2,2	34404-22	34405-22	34406-22
2,3	34404-23	34405-23	34406-23
2,4	34404-24	34405-24	34406-24
2,5	34404-25	34405-25	34406-25
2,8	34404-28	34405-28	34406-28
3,0	34404-30	34405-30	34406-30

Kirschner  
mit flachem Ende / with flat shaft  
con extremo plano / con extremo piatto

Trokarspitze / Trocar point  
Punta trocar / Punte trequarti

Ø	10 cm, 4"	15 cm, 6"	31 cm, 12 1/4"
0,8	34407-08	34408-08	34409-08
0,9	34407-09	34408-09	34409-09
1,0	34407-10	34408-10	34409-10
1,1	34407-11	34408-11	34409-11
1,2	34407-12	34408-12	34409-12
1,3	34407-13	34408-13	34409-13
1,4	34407-14	34408-14	34409-14
1,5	34407-15	34408-15	34409-15
1,6	34407-16	34408-16	34409-16
1,7	34407-17	34408-17	34409-17
1,8	34407-18	34408-18	34409-18
1,9	34407-19	34408-19	34409-19
2,0	34407-20	34408-20	34409-20
2,2	34407-22	34408-22	34409-22
2,3	34407-23	34408-23	34409-23
2,4	34407-24	34408-24	34409-24
2,5	34407-25	34408-25	34409-25
2,8	34407-28	34408-28	34409-28
3,0	34407-30	34408-30	34409-30

Kirschner  
Trokarende / Trocar shaft  
Punta trocar / Punte trequarti Bilaterali

Lanzenspitze / Lance point  
Punta lanceolar / Punte lanceolata

Ø	31 cm, 12 1/4"
0,8	34410-08
0,9	34410-09
1,0	34410-10
1,1	34410-11
1,2	34410-12
1,3	34410-13
1,4	34410-14
1,5	34410-15
1,6	34410-16
1,7	34410-17
1,8	34410-18
1,9	34410-19
2,0	34410-20
2,2	34410-22
2,3	34410-23
2,4	34410-24
2,5	34410-25
2,8	34410-28
3,0	34410-30

Kirschner  
mit flachem Ende / with flat shaft  
con extremo plano / con extremo piatto

lieferbar in Packungen à 10 Stück  
 available in packages of 10 pieces  
 disponible en paquetes de 10 unidades  
 disponibili solo in confezioni da 10 pezzi

Bohrdrähte, Knochennägel  
 Drill Wires, Fracture pins  
 Alambres, Clavos para huesos  
 Perforatori filiformi, Chiodi per ossa

Lanzenspitze / Lance point  
 Punta lanceolar / Punta lanceolata



Ø	31 cm, 12 1/4"
0,8	34411-08
0,9	34411-09
1,0	34411-10
1,1	34411-11
1,2	34411-12
1,3	34411-13
1,4	34411-14
1,5	34411-15
1,6	34411-16
1,7	34411-17
1,8	34411-18
1,9	34411-19
2,0	34411-20
2,2	34411-22
2,3	34411-23
2,4	34411-24
2,5	34411-25
2,8	34411-28
3,0	34411-30

Trokarspitze / Trocar point  
 Punta trocar / Punta trequarti



	Ø	Ø	Ø	Ø	Ø
	3,5 mm	4,0 mm	4,5 mm	5,0 mm	6,0 mm
8 cm, 3 1/8"	34412-08	34413-08	34415-08	34417-08	34419-08
10 cm, 4"	34412-10	34413-10	34415-10	34417-10	34419-10
12 cm, 4 3/4"	34412-12	34413-12	34415-12	34417-12	34419-12
14 cm, 5 1/2"	34412-14	34413-14	34415-14	34417-14	34419-14
16 cm, 6 1/4"	34412-16	34413-16	34415-16	34417-16	34419-16
18 cm, 7"	34412-18	34413-18	34415-18	34417-18	34419-18
20 cm, 8"	34412-20	34413-20	34415-20	34417-20	34419-20
22 cm, 8 3/4"	34412-22	34413-22	34415-22	34417-22	34419-22
23 cm, 9"	34412-23	34413-23	34415-23	34417-23	34419-23
24 cm, 9 1/2"	34412-24	34413-24	34415-24	34417-24	34419-24
26 cm, 10 1/4"	34412-26	34413-26	34415-26	34417-26	34419-26
28 cm, 11"	34412-28	34413-28	34415-28	34417-28	34419-28
30 cm, 11 3/4"	34412-30	34413-30	34415-30	34417-30	34419-30

Kirschner  
 mit rundem Ende / with round shaft  
 con extremo redondo / con extremo rotondo

Steinmann  
 mit rundem Ende / with round shaft  
 con extremo redondo / con extremo rotondo

Trokarspitze / Trocar point  
 Punta trocar / Punta trequarti



	Ø	Ø	Ø	Ø	Ø
	3,5 mm	4,0 mm	4,5 mm	5,0 mm	6,0 mm
8 cm, 3 1/8"	34420-08	34421-08	34423-08	34425-08	34427-08
10 cm, 4"	34420-10	34421-10	34423-10	34425-10	34427-10
12 cm, 4 3/4"	34420-12	34421-12	34423-12	34425-12	34427-12
14 cm, 5 1/2"	34420-14	34421-14	34423-14	34425-14	34427-14
16 cm, 6 1/4"	34420-16	34421-16	34423-16	34425-16	34427-16
18 cm, 7"	34420-18	34421-18	34423-18	34425-18	34427-18
20 cm, 8"	34420-20	34421-20	34423-20	34425-20	34427-20
22 cm, 8 3/4"	34420-22	34421-22	34423-22	34425-22	34427-22
23 cm, 9"	34420-23	34421-23	34423-23	34425-23	34427-23
24 cm, 9 1/2"	34420-24	34421-24	34423-24	34425-24	34427-24
26 cm, 10 1/4"	34420-26	34421-26	34423-26	34425-26	34427-26
28 cm, 11"	34420-28	34421-28	34423-28	34425-28	34427-28
30 cm, 11 3/4"	34420-30	34421-30	34423-30	34425-30	34427-30

Steinmann  
 Trokarende / Trocar shaft  
 Punta trocar / Punta trequarti Bilateralis

Knochennägel  
Fracture pins  
Clavos para huesos  
Chiodi per ossa

lieferbar in Packungen à 10 Stück  
available in packages of 10 pieces  
disponible en paquets de 10 unidades  
disponibili solo in confezioni da 10 pezzi

Trokarspitze / Trocar point  
Punta trocar / Punta trequarti



	Ø	Ø	Ø	Ø	Ø
	3,5 mm	4,0 mm	4,5 mm	5,0 mm	6,0 mm
8 cm, 3 1/8"	34428-08	34429-08	34431-08	34433-08	34435-08
10 cm, 4"	34428-10	34429-10	34431-10	34433-10	34435-10
12 cm, 4 3/4"	34428-12	34429-12	34431-12	34433-12	34435-12
14 cm, 5 1/2"	34428-14	34429-14	34431-14	34433-14	34435-14
16 cm, 6 1/4"	34428-16	34429-16	34431-16	34433-16	34435-16
18 cm, 7"	34428-18	34429-18	34431-18	34433-18	34435-18
20 cm, 8"	34428-20	34429-20	34431-20	34433-20	34435-20
22 cm, 8 3/4"	34428-22	34429-22	34431-22	34433-22	34435-22
23 cm, 9"	34428-23	34429-23	34431-23	34433-23	34435-23
24 cm, 9 1/2"	34428-24	34429-24	34431-24	34433-24	34435-24
26 cm, 10 1/4"	34428-26	34429-26	34431-26	34433-26	34435-26
28 cm, 11"	34428-28	34429-28	34431-28	34433-28	34435-28
30 cm, 11 3/4"	34428-30	34429-30	34431-30	34433-30	34435-30

Steinmann  
mit 3-kant-Ende / with triangular end  
con extremo triangular / con estremo triangolare

Trokarspitze / Trocar point  
Punta trocar / Punta trequarti

mit Gewinde  
threaded Wires  
con rosca  
con filetto



	Ø	15 cm, 6"	18 cm, 7"	20 cm, 8"	23 cm, 9"	25 cm, 10"	31 cm, 12 1/4"
1,6	34436-16	34437-16	34438-16	34439-16	34440-16	34441-16	
1,8	34436-18	34437-18	34438-18	34439-18	34440-18	34441-18	
2,0	34436-20	34437-20	34438-20	34439-20	34440-20	34441-20	
2,5	34436-25	34437-25	34438-25	34439-25	34440-25	34441-25	
2,8	34436-28	34437-28	34438-28	34439-28	34440-28	34441-28	
3,0	34436-30	34437-30	34438-30	34439-30	34440-30	34441-30	

mit rundem Ende / with round shaft  
con extremo redondo / con estremo rotondo

lieferbar in Packungen à 10 Stück  
 available in packages of 10 pieces  
 disponible en paquets de 10 unidades  
 disponibili solo in confezioni da 10 pezzi

Knochennägel  
 Fracture pins  
 Clavos para huesos  
 Chiodi per ossa

Trokarspitze / Trocar point  
 Punta trocar / Punta trequarti

mit Gewinde  
 threaded Wires  
 con rosca  
 con filetto



Ø	15 cm, 6"	18 cm, 7"	20 cm, 8"	23 cm, 9"	25 cm, 10"	31 cm, 12 1/4"
1,6	34442-16	34443-16	34444-16	34445-16	34446-16	34447-16
1,8	34442-18	34443-18	34444-18	34445-18	34446-18	34447-18
2,0	34442-20	34443-20	34444-20	34445-20	34446-20	34447-20
2,5	34442-25	34443-25	34444-25	34445-25	34446-25	34447-25
2,8	34442-28	34443-28	34444-28	34445-28	34446-28	34447-28
3,0	34442-30	34443-30	34444-30	34445-30	34446-30	34447-30

Trokarende / Trocar shaft  
 Punta trocar / Punta trequarti

Bohrdrahtspender  
 K-Wire Dispenser  
 Dispensador para brocas filiformes  
 Distributore per fili

12 cm, 4 3/4"



17 cm, 6 3/4"



33 cm, 13"



34450-08 0,8 mm  
 34450-10 1,0 mm  
 34450-12 1,2 mm  
 34450-14 1,4 mm  
 34450-15 1,5 mm  
 34450-16 1,6 mm  
 34450-18 1,8 mm  
 34450-20 2,0 mm  
 34450-22 2,2 mm  
 34450-25 2,5 mm  
 34450-30 3,0 mm

34460-08 0,8 mm  
 34460-10 1,0 mm  
 34460-12 1,2 mm  
 34460-14 1,4 mm  
 34460-15 1,5 mm  
 34460-16 1,6 mm  
 34460-20 2,0 mm  
 34460-22 2,2 mm  
 34460-25 2,5 mm  
 34460-30 3,0 mm

34470-08 0,8 mm  
 34470-10 1,0 mm  
 34470-12 1,2 mm  
 34470-14 1,4 mm  
 34470-15 1,5 mm  
 34470-16 1,6 mm  
 34470-20 2,0 mm  
 34470-22 2,2 mm  
 34470-25 2,5 mm  
 34470-30 3,0 mm



Fingerschützer, Drahtgeflecht  
Finger Protectors, Wire gauze  
Dedales, Gasa metálica  
Proteggidita, maglia metallica per estensione



34480-01



34480-02



34480-03

LANGENBECK  
34480-01 - 34480-03



34492-01  
klein / small / pequeño / stretto

34492-02  
mittel / medium / mediano / medio

34492-03  
groß / large / grande / grande

34492-01 - 34492-03

sterilisierbar  
sterilizable  
esterilizabile  
sterilizzabile

Extensionsbügel  
 Extension Bows  
 Estribos para extensión  
 Archi per estensione

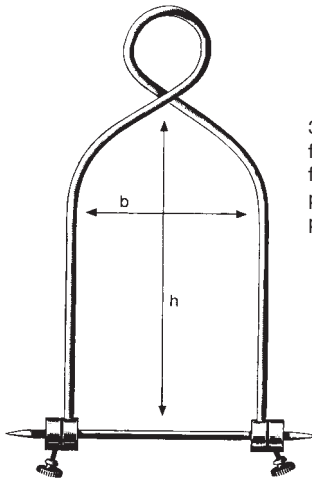

34502-16  
 für Arm  
 for arm  
 para brazo  
 per braccio

16 x 9 cm  
 6 1/4" x 3 1/2"

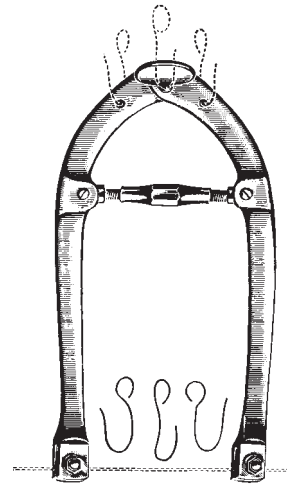

KIRSCHNER

BÖHLER

34502-15 21 x 15 cm 8 1/4" x 6"  
 34502-21 21 x 11 cm 8 1/4" x 4 3/8"  
 für Oberschenkel und Knie  
 for thigh and knee  
 para femur y rodilla  
 per femore e ginocchio

34514-18 40 - 140 mm x 115 mm mit 3 Zughaken  
 with 3 hooks  
 con 3 ganchos  
 con 3 ganci per trazione

34514-27 60 - 220 mm x 175 mm mit 3 Zughaken  
 with 3 hooks  
 con 3 ganchos  
 con 3 ganci per trazione

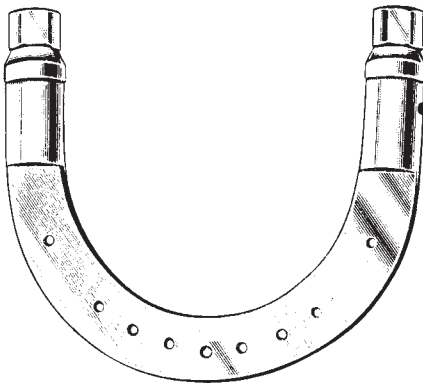

KIRSCHNER

34515-09 9,5 x 7,0 cm 3 3/4" x 2 3/4"  
 34515-10 9,5 x 11,0 cm 3 3/4" x 4 3/8"  
 34515-11 10,5 x 10,0 cm 4.1" x 4"  
 34515-12 12,0 x 12,0 cm 4 3/4" x 4 3/4"  
 34515-13 13,5 x 13,0 cm 5 1/4" x 5 1/8"  
 34515-15 15,5 x 15,5 cm 6" x 6"  
 34515-20 20,0 x 15,5 cm 8" x 6"

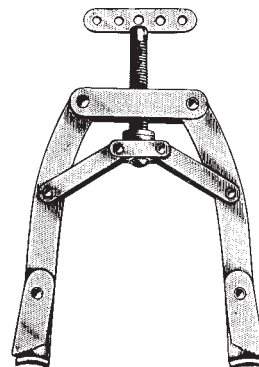

KIRSCHNER U.S.

34518-01  
 mittel, medium, mediano, max. 130 mm (5 1/8")  
 34518-02  
 groß, large, grande, grande, max. 185 mm (7 1/4")

34518-03  
 extra groß, large extra long, muy grande, max. 220 mm (8 3/4")

Spannschlüssel, Zughaken  
Tightening wrench, hooks  
Llave tensora, ganchos  
Chiave, ganci per trazione



34515-01

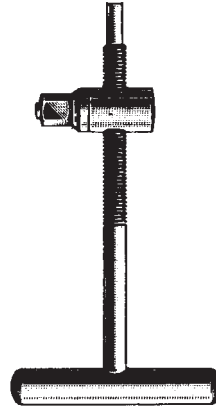

34515-02

KIRSCHNER  
34519-01KIRSCHNER  
34519-02

Knochendraht  
Bone wire  
Hilos para huesos  
Filo per ossa



weich, in Ringen zu 10 m (32,8 Feet)  
soft, in coils of 10 m (32,8 Feet)  
blando, de 10 m (32,8 Feet)  
morbido, 10 m (32,8 Feet)

Material:  
nichtrostender Implantatstahl  
nach DIN 17443 (ISO 5832/1)

	mm Ø
34520-02	0,2
34520-03	0,3
34520-04	0,4
34520-05	0,5
34520-06	0,6
34520-07	0,7
34520-08	0,8
34520-09	0,9
34520-10	1,0
34520-12	1,2
34520-15	1,5

Drahtumföhrungsnadeln, Drahtspanninstrumente  
 Bone wire guides, Bone wire tighteners  
 Agujas pasa-hilos, Tensor cierra-hilos  
 Aghi passafili, Strumenti tendifili



DEMEL

27 cm, 10 1/2"

Fig. 1 34528-01

Fig. 2 34528-02

Fig. 3 34528-03

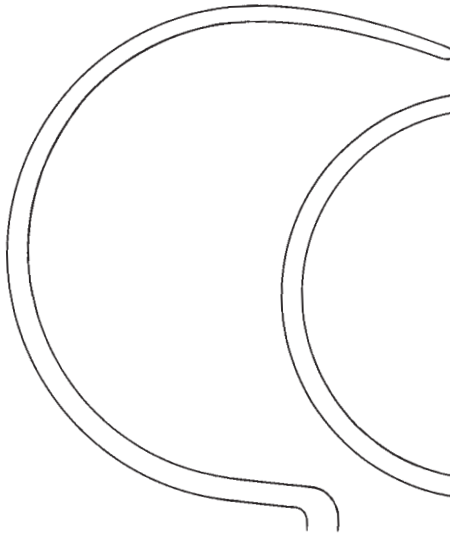

Fig. 1

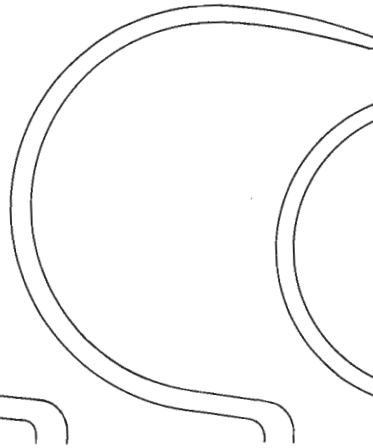

Fig. 2

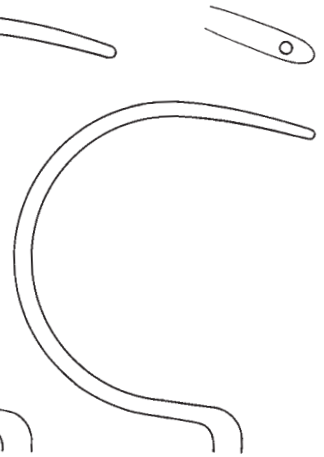
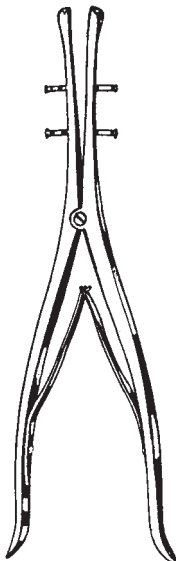
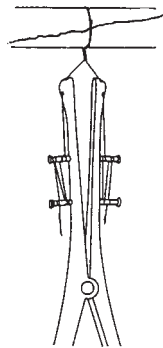

Fig. 3



DEMEL

34530-28 28 cm, 11"



LOUTE

34531-21 21 cm, 8 1/4"

Flachzangen, Faßzangen  
 Flat Nose Pliers, Seizing Forceps  
 Alicates planos, Pinzas para coger alambres  
 Tenaglie piatte, Tenaglie per afferrare



17 cm, 6 3/4"  
 34533-17



GRIP  
 18 cm, 7"  
 34534-18



34534-15  
 15 cm, 6"



34535-16  
 16 cm, 6 1/4"

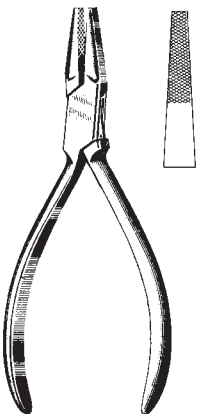

34536-14  
 14 cm, 5 1/2"



34537-19  
 19 cm, 7 1/2"



18 cm, 7"

2 mm

4 mm

6 mm



34538-01

34538-02

34538-03

34539-01 TC 34539-02 TC 34539-03 TC

Flachzangen, Drahtkneifzangen  
Flat Nose Pliers, Wire cutting Pliers  
Alicates planos, Alicates para cortar alambres  
Tenaglie piatte, Tenaglie tagliafili



34540-01



34540-02

17 cm, 6 <sup>3</sup>/<sub>4</sub>"34540-16  
16 cm, 6 <sup>1</sup>/<sub>4</sub>"  
soft wire 2,0 mm34540-18  
18 cm, 7"34540-19  
18 cm, 7"34540-20  
20 cm, 8"

Drahtkneifzangen  
Wire cutting Pliers  
Alicates para cortar alambres  
Tenaglie tagliafili



34541-23 TC 23 cm, 9"

soft wire 3,0 mm  
hard wire 2,2 mm

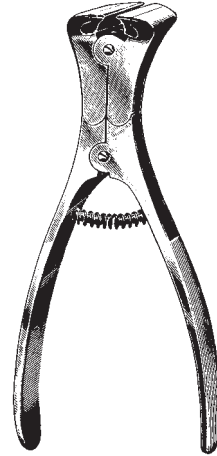

34542-15 TC 15 cm, 6"

Soft wire 2,0 mm  
hard wire 1,5 mm



34543-23 TC 23 cm, 9"

Soft wire 3,5 mm  
hard wire 2,5 mm



34544-18 TC 18 cm, 7"

Soft wire 2,5 mm  
hard wire 1,5 mm





Drahtkneifzangen, Drahtfaßzangen  
 Wire Cutting Pliers, Wire Seizing Forceps  
 Alicates para cortar alambres, Pinzas para coger alambres  
 Tronchese taglienti, Tenaglie per afferrare i fili



für harten Draht bis  
2,2 mm Ø  
for hard wires up to  
2,2 mm Ø  
para hilos duros  
hasta 2,2 mm Ø  
per fili duri a  
2,2 mm Ø

für weichen Draht bis  
2,5 mm Ø  
for soft wires up to  
2,5 mm Ø  
para hilos blandos  
hasta 2,5 mm Ø  
per fili dolci fino a  
2,5 mm Ø

34545-22 TC 22 cm, 8 3/4"

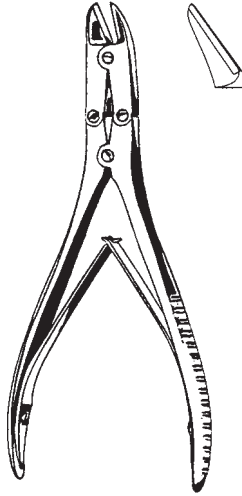

für harten Draht bis 1,6 mm Ø  
for hard wires up to 1,6 mm Ø  
para hilos duros hasta 1,6 mm Ø  
per fili duri a 1,6 mm Ø

für weichen Draht bis 2,0 mm Ø  
for soft wires up to 2,0 mm Ø  
para hilos blandos hasta 2,0 mm Ø  
per fili dolci fino a 2,0 mm Ø

34546-16 TC 16 cm, 6 1/4"  
34546-18 TC 18 cm, 7"

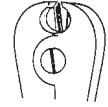

für weichen Draht bis  
2,0 mm Ø  
for soft wires up to  
2,0 mm Ø  
para hilos blandos  
hasta 2,0 mm Ø  
per fili dolci fino a  
2,0 mm Ø

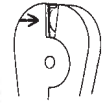

für harten Draht bis  
1,6 mm Ø  
for hard wires up to  
1,6 mm Ø  
para hilos duros  
hasta 1,6 mm Ø  
per fili duri a  
1,6 mm Ø

34548-18 TC 18 cm, 7"



soft wire 1,5 mm  
hard wire 1,0 mm

34549-14 TC 14 cm, 5 1/2"



34550-13 13 cm, 5 1/8"  
34550-18 18 cm, 7"

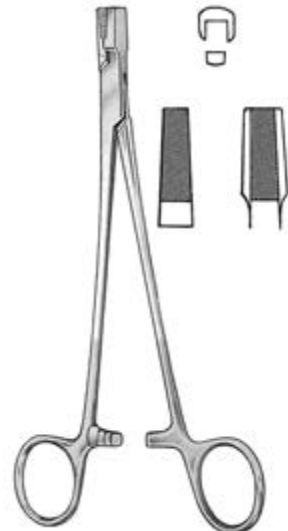

34551-17 TC 17 cm, 6 3/4"

Drahtzangen  
 Wire Twisting Forceps  
 Pinzas para torcer hilos  
 Pinza torcifili



CORWIN-HEGAR  
 34552-16 TC 16 cm, 6 1/4"



BERRY  
 34556-18 TC 18 cm, 7"



MAYO-HABERISSER

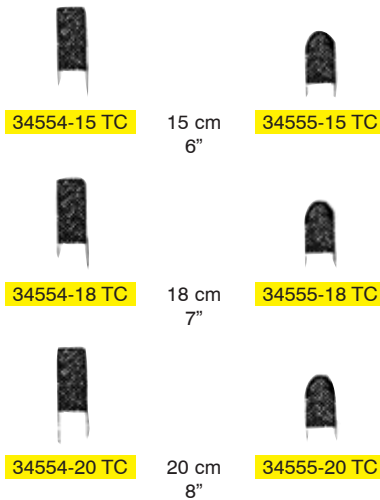

Drahtkneifzange  
Pin cutter  
Alicates para cortar clavos  
Ghigliottina per tagliare fili fino



34557-22 22 cm, 8 <sup>3</sup>/<sub>4</sub>"  
34557-25 25 cm, 10"  
34557-30 30 cm, 11 <sup>3</sup>/<sub>4</sub>"



bis 2.2 mm  
up to 2.2 mm  
hasta 2.2 mm  
a 2.2 mm

34558-32 32 cm, 12 <sup>1</sup>/<sub>2</sub>"



bis 6 mm  
up to 6 mm  
hasta 6 mm  
a 6 mm

34559-47 TC 47 cm, 18 <sup>1</sup>/<sub>2</sub>"



bis 6.5 mm  
up to 6.5 mm  
hasta 6.5 mm  
a 6.5 mm

34560-57 TC 57 cm 22 <sup>1</sup>/<sub>2</sub>"

Drahtkneifzange  
Wire Cutter  
Alicate para alambre  
Tronchese tagliafili

**HERCULES****34547-23 TC 23 cm / 9"**

für Bohrdrähte bis max. 3 mm Ø  
über 40% Kraftersparnis durch Spezialmechanik  
auswechselbare Hartmetallschneiden  
auswechselbare Gummibacken  
komplett sterilisierbar

for drill wires of max 3 mm Ø  
over 40% less power required by special mechanic  
exchangeable TC-blades  
exchangeable rubber jaws  
full sterilisable

para taladros filiformes de max. 3 mm Ø  
reducción de la fuerza manual en más de un 40%  
placas de tungsteno intercambiables  
bocas de goma intercambiables  
complemente esterilizable

con riduzione di forza più del 40%  
Per fili perforatori fino a 3 mm  
Placche taglienti al TC intercambiabili  
Ganasce in gomma intercambiabili  
Completamente sterilizzabili

Ersatzteilsets  
Spare Part Sets  
Juegos de recambios  
Set per parti di ricambio

**34547-01**

1 Paar Hartmetallschneiden / 2 Paar Schrauben / 1 Inbusschlüssel  
1 pair of TC-blades / 2 pairs of screws / 1 Allen key  
1 par de placas de tungsteno / 2 pares de tornillos / 1 llave hexagonal  
1 Paio di placche TC / 2 Paio di viti da fissaggio / 1 chiave esagonale

**34547-03**

1 Paar Gummibacken / 1 Paar Schrauben  
1 pair of rubber jaws / 1 pair of screws  
1 par de bocas de goma / 1 par de tornillos  
1 Paio ganasce in gomma / 1 Paio di viti da fissaggio

Drahtkneifzange  
Wire Cutter  
Alicate para alambre  
Tronchese tagliafilii



#### HERCULES

34547-28 TC 28 cm / 11"

für Bohrdrähte ab 2,5 - 4,0 mm  
über 40% Kraftersparnis durch Spezialmechanik  
auswechselbare Hartmetallschneiden  
auswechselbare Gummibacken  
komplett sterilisierbar

for drill wires of 2.5 - 4.0 mm  
over 40% less power required by special mechanic  
exchangeable TC-blades  
exchangeable rubber jaws  
full sterilisable

para taladros filiformes de 2,5 - 4,0 mm  
reducción de la fuerza manual en más de un 40%  
placas de tungsteno intercambiables  
bocas de goma intercambiables  
complemente esterilizable

con riduzione di forza più del 40%  
Per fili perforatori fino a 2,5 - 4,0 mm  
Placche taglienti al TC intercambiabili  
Ganasce in gomma intercambiabili  
Completamente sterilizzabili

Ersatzteilsets  
Spare Part Sets  
Juegos de recambios  
Set per parti di ricambio



34547-02

1 Paar Hartmetallschneiden / 2 Paar Schrauben / 1 Inbusschlüssel  
1 pair of TC-blades / 2 pairs of screws / 1 Allen key  
1 par de placas de tungsteno / 2 pares de tornillos / 1 llave hexagonal  
1 Paio di placche TC / 2 Paio di viti da fissaggio / 1 chiave esagonale



34547-03

1 Paar Gummibacken / 1 Paar Schrauben  
1 pair of rubber jaws / 1 pair of screws  
1 par de bocas de goma / 1 par de tornillos  
1 Paio ganasce in gomma / 1 Paio di viti da fissaggio

Drahtkneifzange  
Wire Cutter  
Alicate para alambre  
Tronchese tagliafili

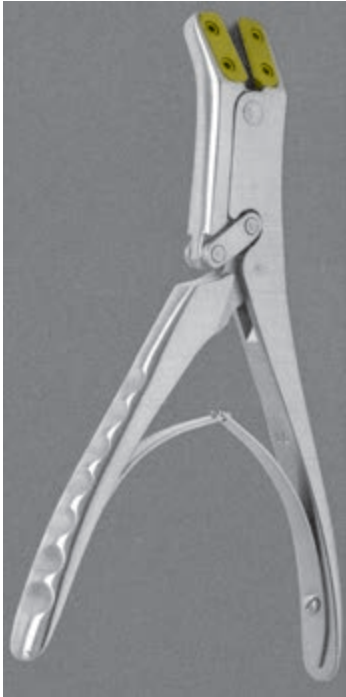

**HERCULES**

**35548-18 TC 18 cm / 7"**

für Bohrdrähte bis max. Ø 2,2 mm  
über 40% Kraftersparnis durch Spezialmechanik, auswechselbare  
Hartmetallschneiden  
auswechselbare Gummibacken  
komplett sterilisierbar

for drill wires of max 0 2.2 mm  
over 40% less power required by special mechanic  
exchangeable TC-blades  
exchangeable rubber jaws  
full sterilisable

para taladros filiformes de max. Ø 2,2 mm  
reducción de la fuerza manual en más de un 40%  
placas de tungsteno intercambiables  
bocas de goma intercambiables  
complemente esterilizable

con riduzione di forza più del 40%  
Per fili perforatori da 2,2 mm  
Utilizzabile a scelta per mano sinistra e destra  
Placche taglienti al TC intercambiabili  
Ganasce in gomma intercambiabili  
Completamente sterilizzabili

für Rechtshänder / for right-handers /  
para la mano derecha / per mano destra



Ersatzteilsets  
Spare Part Sets  
Juegos de recambios  
Set per parti di ricambio



35547-01  
1 Paar Hartmetallschneiden / 2 Paar Schrauben / 1 Inbusschlüssel  
1 pair of TC-blades / 2 pairs of screws / 1 Allen key  
1 par de placas de tungsteno / 2 pares de tornillos / 1 llave hexagonal  
1 Paio di placche TC / 2 Paio di viti da fissaggio / 1 chiave esagonale



34547-03  
1 Paar Gummibacken / 1 Paar Schrauben  
1 pair of rubber jaws / 1 pair of screws  
1 par de bocas de goma / 1 par de tornillos  
1 Palo ganasce in gomma / 1 Paio di viti da fissaggio





Instrumentarium für Ender und Küntscher Nägel  
 Instruments for ender and Küntscher Nails  
 Instrumental para Clavos Ender y Küntscher  
 Strumentario per chiodi di Ender e Küntscher

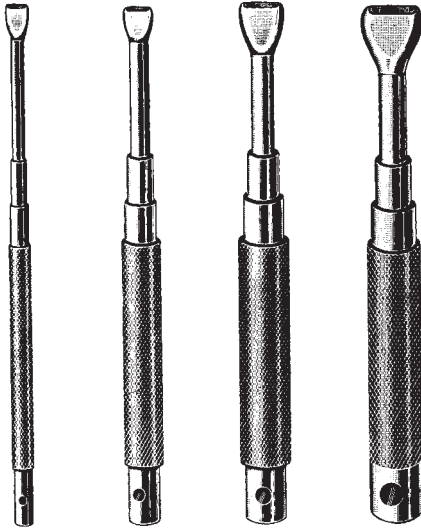

34562-24	34562-32	34562-48	34562-64
f./p. Ø 2,4 mm	3,2 mm	4,8 mm	6,4 mm

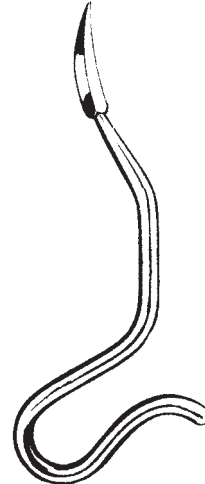

KÜNTSCHER	26 cm, 10 1/4"
34570-01	8 mm
34570-02	10 mm

Ein- und Ausschlaginstrumente für Ender-Nägel  
 Driver-extractors for Ender nails  
 Impactors-Extractores para clavos de Ender  
 Impattatore-Estrattore per chiodi di Ender

Vorbohrer zum Öffnen der Markhöhle  
 Reamers for medullary cave  
 Perforadores para la cavidad medular  
 Alesatore per l'apertura del midollo



KÜNTSCHER  
 34573-35 35 cm, 13 3/4"  
 Aufreiber für Oberschenkel  
 Reamer for femur  
 Perforador para fémur  
 Alesatore per femore



mm Ø	L = 60 cm, 23 3/4"
3,5	34583-60
4,0	34584-60
5,0	34585-60

Führungsspieße  
 Guide pins  
 Guía-conductora para clavos medulares  
 Guida conduttrice



für Nägel for nails para clavos per chiodi
Ø 6-8 mm 34588-01
Ø 9-12 mm 34588-02
Ø 12-17 mm 34588-03

KUENTSCHER 19 cm, 7 1/2"  
 Fertigschläger  
 Nail impactors  
 Impactor final  
 Impattatore finale

Instrumentarium für Küntscher Nägel  
 Instruments for Küntscher Nails  
 Instrumental para Clavos Küntscher  
 Strumentario per chiodi di Küntscher



34590-01



34590-02

KÜNTSCHER

34590-00 63 cm, 24 3/4"

komplett mit 2 Haken 34590-01/02

complete with 2 hooks 34590-01/02

completo con 2 ganchos 34590-01/02

completo con 2 ganci 34590-01/02

Extraktor

Nail extractor

Aparato extractor

Estrattore



Extraktionshaken

Extraction hooks

Ganchos extractores

Gancio d'estrazione

34596-29 29 cm 11.4"

34596-37 37 cm 14.5"

34596-42 42 cm 16.5"

34596-49 49 cm 19.3"



Markraumborher

Intramedullary drills

Perforadores medulares

Perforatore intramidollare

Ø

6,0 mm 34597-06

7,0 mm 34597-07

8,0 mm 34597-08

9,0 mm 34597-09

10,0 mm 34597-10

11,0 mm 34597-11

12,0 mm 34597-12

13,0 mm 34597-13

14,0 mm 34597-14

15,0 mm 34597-15

16,0 mm 34597-16

17,0 mm 34597-17

18,0 mm 34597-18

19,0 mm 34597-19

20,0 mm 34597-20

Instrumentarium für Küntscher Nägel  
Instruments for Küntscher Nails  
Instrumental para Clavos Küntscher  
Strumentario per chiodi di Küntscher



Einschläger / Nail Inserter  
Introducer clavos / Impattore  
34612-00



Impactor  
34613-00



BENDER  
34615-00

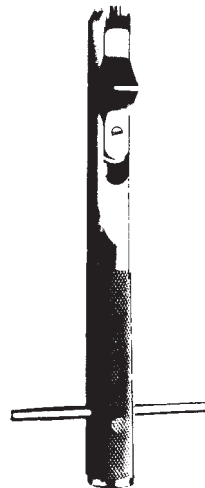

Impactor-Extractor  
Impattore-Estrattore  
34617-00



Schraubenzieher  
Screw Drivers  
Destornilladores  
Cacciaviti

6 mm



LANE  
34620-25 25 cm, 10"

3,5 mm



34624-01



34624-02



WILLIAMS  
24 cm, 9 1/2"



34624-03



34624-04



mit Ferrozellgriff  
with Ferrozell handle  
con mango de Ferrozell  
con manico di Ferrozell



34628-01  
25 cm, 10"



34628-02  
25 cm, 10"



34629-01  
25 cm, 10"



1,5 mm  
34628-15  
20 cm, 8"



2,5 mm  
34628-25  
25 cm, 10"



3,5 mm  
34628-35  
25 cm, 10"

Schraubenzieher  
Screw Drivers  
Destornilladores  
Cacciaviti



LANE  
34632-25 25 cm, 10"  
Kreuzschlitzschraubenzieher  
Screwdriver for cross slotted head  
Destornillador para tornillos con ranura en cruz  
Cacciavite a croce

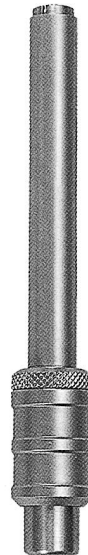

Schraubenhaltehülse für Sechskantschrauben  
Screw holder  
Vaina para tornillos  
Guaina per viti esagonali  
34634-35 3,5 mm

Haltezangen, Biegehebel  
 Holding Forceps, Bender  
 Pinzas para sostener placas y tornillos, Palanca  
 Pinza portaplacca, leva piegaplacche

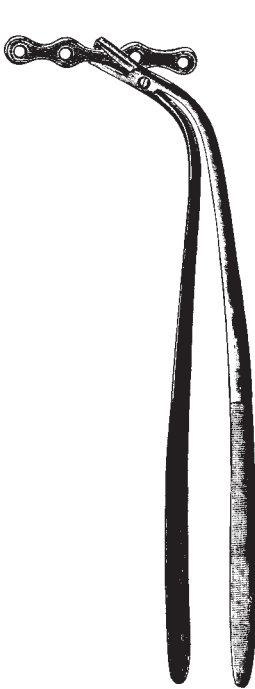

LANE  
 34637-23 23 cm, 9"

Knochenplatten-Haltezange  
 Plate Holding Forceps  
 Pinza para sostener placas  
 Pinza portaplacche



LANE  
 34639-22 22 cm, 8 3/4"

Schraubenhalte-  
 zange  
 Screw Holding  
 Forceps  
 Pinza para sostener  
 tornillos  
 Pinza portaviti

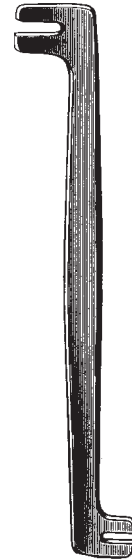

LANE  
 34640-18 18 cm, 7"

Biegehebel f. Knochenplatten  
 Plate Bender  
 Palanca para doblar placas  
 Leva piegaplacche

Anlegezangen, Silberklammern  
 Applying Fcps. Clips  
 Pinzas aplicadoras, Grapas  
 Pinza per applicare, Agrafes

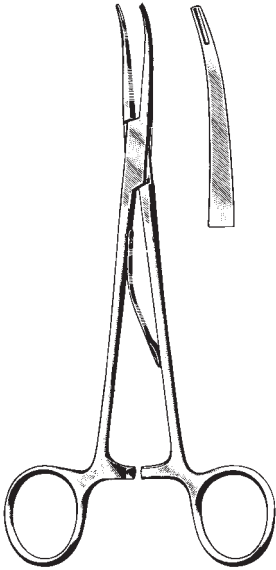

McKENZIE

41011-15 15 cm, 6"  
 41011-19 19 cm, 7 1/2"

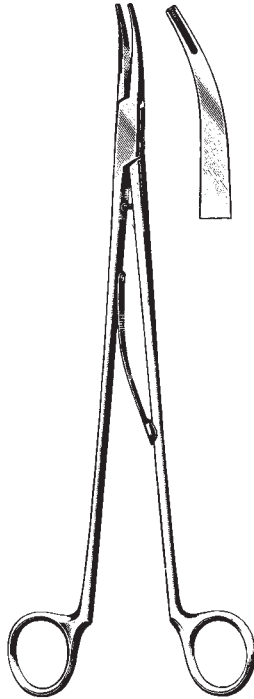

SMITHWICK

41015-23 23 cm, 9"  
 41015-26 26 cm, 10 1/4"

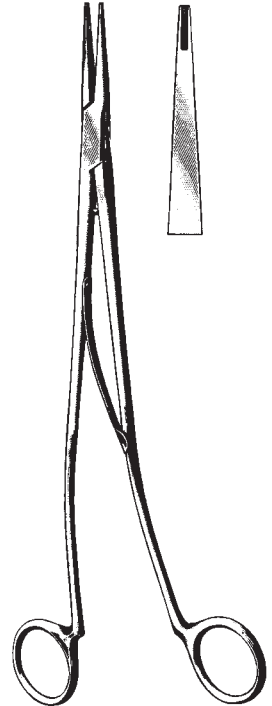

SWEET

41017-23 23 cm, 9"  
 41017-26 26 cm, 10 1/4"



OLIVECRONA-TOENNIS  
 41019-14

41020-00  
 148 x 40 x 6 mm

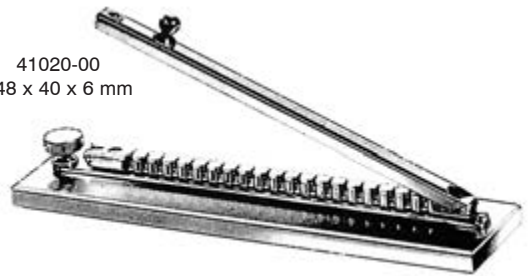

41021-00  
 (100 pcs.)





Schädelhalter, Kopfhautklammer, Anlegezange  
Cervical Traction Tongs, Clips, Applying Forceps  
Pinzas de tracción craneal, Clips, Pinza para aplicar clips  
Pinze per trazione craniale, Pinza per applicare

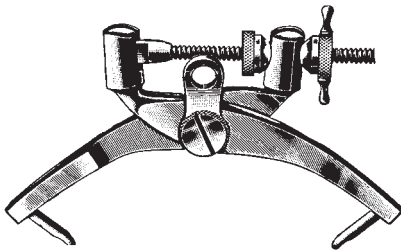

CRUTCHFIELD  
41025-01



CRUTCHFIELD  
41025-02



41026-35  
3,5 mm Ø



41026-50  
5 mm Ø

Stainless steel  
Acciaio inox



RANEY  
41027-00



RANEY  
41028-00 16 cm, 6 1/4"

Nervhaken, Durahaken  
 Nerve Hooks, Dura Hooks  
 Ganchos para nervios y para dura-madre  
 Uncini per nervi e per dura-madre



DANDY  
 41051-20  
 20 cm, 8"



DANDY  
 41052-20  
 20 cm, 8"



DANDY  
 41053-20  
 20 cm, 8"



CRILE  
 41054-20  
 20 cm, 8"

Fig. 1



CUSHING  
 41056-18 18 cm, 7"  
 41056-28 28 cm, 11"

Fig. 2

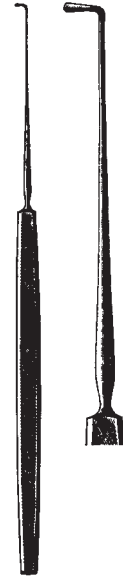

CUSHING  
 41058-18 18 cm, 7"  
 41058-28 28 cm, 11"

Nervhaken, Durahaken  
Nerve Hooks, Dura Hooks  
Ganchos para nervios y para dura-madre  
Unicini per nervi e per dura-madre



GRAHAM  
41061-16  
16,5 cm, 6 1/2"



SACHS  
41064-16  
18,5 cm, 7 1/4"



ADSON  
41068-20  
20 cm, 8"



ADSON  
41069-20  
20 cm, 8"



SMITHWICK  
41070-29  
29 cm, 11.4"

Nervwurzelnhaken  
 Nerve Root Retractors  
 Separadores de raiz de nervios  
 Uncini per le radici dei nervi

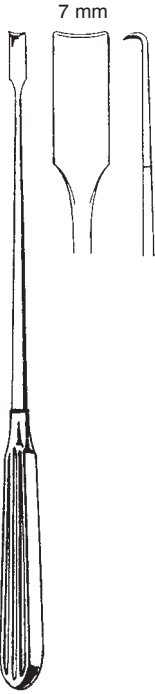

SCOVILLE  
 41074-23  
 23 cm, 9"

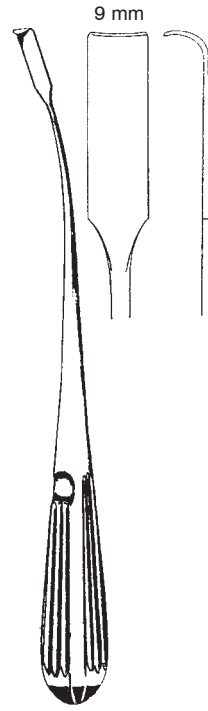

HOLSHER  
 41075-24  
 24 cm, 9 1/2"

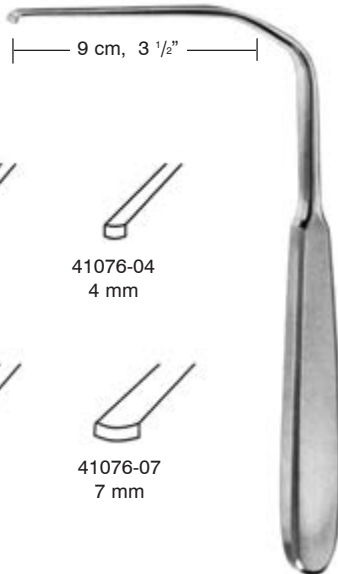

HESS  
 17,5 cm, 7"



Nervwurzelhaken  
Nerve Root Retractors  
Separadores de raíz de nervios  
Uncini per le radici dei nervi

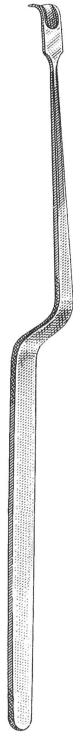

D'ERRICO  
41078-23  
23 cm, 9"



LOVE  
41079-21  
21 cm, 8 1/4"

Nervwurzelhaken, Galeahaken  
 Nerve Root Retractors, Galea Hooks  
 Separadores de raiz de nervios, Gancho para galea  
 Uncini per le radici dei nervi, Uncini galea

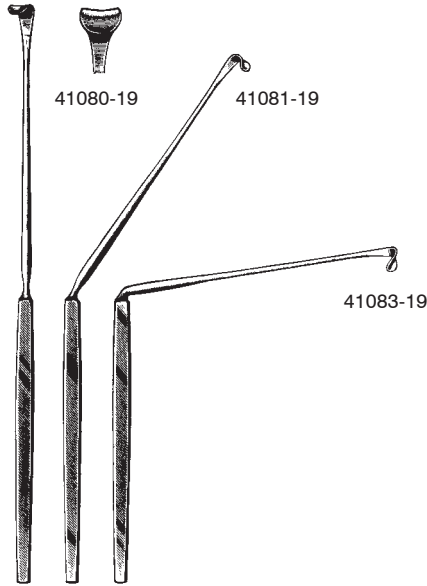

LOVE  
 41080-19 – 41083-19  
 19 cm, 7 1/2"

SCOVILLE  
 41085-20  
 20 cm, 8"



DeMARTEL  
 41090-33  
 33 cm, 13"



YASARGIL  
 41091-31  
 31 cm, 12 1/4"

Galeahaken  
 Galea Hooks  
 Gancho p/galea  
 Gancio p/galea

Ø 7 mm

4 mm



YASARGIL  
 41091-41  
 41 cm, 16"

Ø 9 mm

6 mm

Schädelstanze  
Cranial Punch  
Pinzas sacabocado craneal  
Pinza per craniotomia



CONE  
41097-22  
22,5 cm 9"

Drahtsägen, Schädelzange, Dura Dissektoren  
 Wire Saws, Skull Punches, Dura Dissectors  
 Sierras de hilo, Pinzas sacabocado craneal, Elevadores para la duramadre  
 Fili sega, Pinza per craniotomia, Scollatori per duramadre

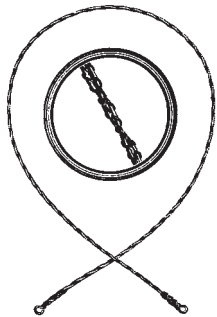

OLIVECRONA	cm
41092-30	30, 11 3/4"
41092-40	40, 15 3/4"
41092-50	50, 19 3/4"
41092-60	60, 23 3/4"
41092-70	70, 27 1/2"

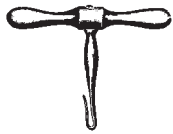

GIGLI  
 41094-00  
 Drahtsägen-Handgriff  
 Wire Saw Handle  
 Mango de gancho  
 Manico con uncino



DeVILBISS  
 41096-21  
 21 cm, 8 1/4"

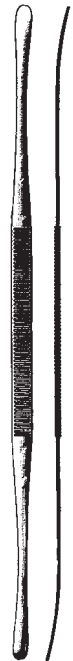

TOENNIS  
 41141-25  
 25 cm, 10"



SACHS  
 41143-21  
 21 cm, 8 1/4"

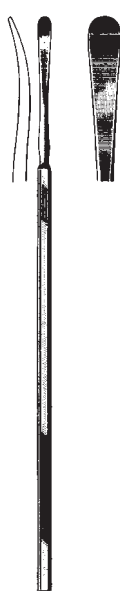

SACHS  
 41145-21  
 21 cm, 8 1/4"

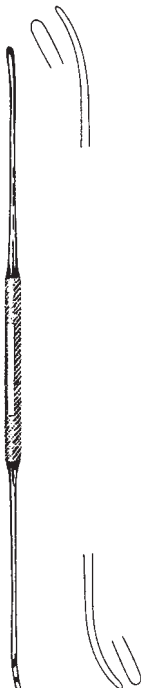

OLIVECRONA  
 41146-18 18 cm, 7"  
 41146-24 24 cm, 9 1/2"

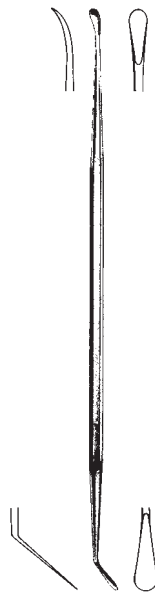

MILLIGAN  
 41147-21  
 21 cm, 8 1/4"



41149-22  
 22 cm, 8 3/4"

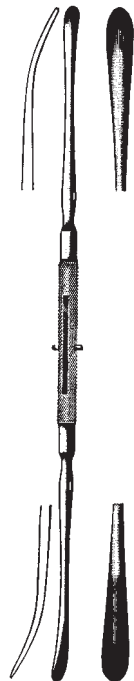

DAVIS  
 41151-24  
 24 cm, 9 1/2"



Dura Dissektoren  
Dura Dissectors  
Elevadores  
Scollatori

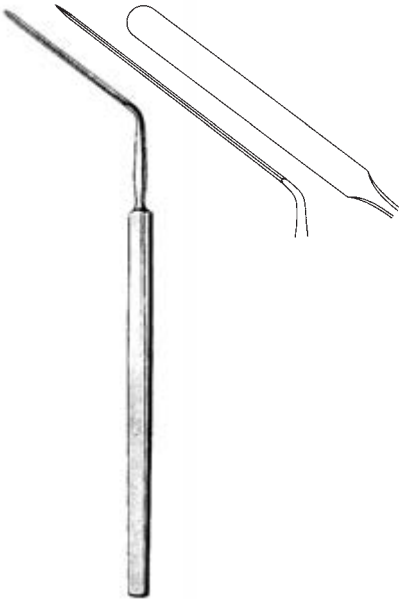

HORSLEY  
41155-20  
20 cm, 8"



WOODSON  
41156-18  
18 cm, 7"



FRAZIER  
41158-01  
15 cm, 6"



HOEN  
41158-02  
15 cm, 6"

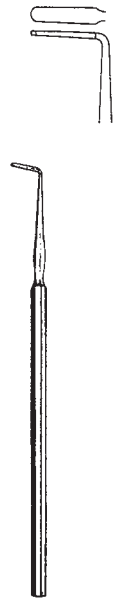

HOEN  
41158-03  
15 cm, 6"



PENFIELD  
41161-01  
17,5 cm, 6.9"



PENFIELD  
41161-02  
19,5 cm, 7 3/4"



PENFIELD  
41161-03  
19,5 cm, 7 3/4"



PENFIELD  
41161-04  
21,5 cm, 8 1/2"



PENFIELD  
41161-05  
29 cm 11.4"

Hypophyse Pinzetten, Küretten  
 Hypophyseal Forceps, Curette  
 Pinzas para hipófisis, Curetas  
 Pinze per ipofisi, Curette



ADSON  
 41210-23  
 23 cm, 9°



ADSON  
 41211-23  
 23 cm, 9°



ADSON  
 41213-23  
 23 cm, 9°



RAY  
 41221-00  
 19 cm, 7 1/2°



RAY  
 41222-00  
 19 cm, 7 1/2°



RAY  
 41223-00  
 19 cm, 7 1/2°



RAY  
 41224-00  
 19 cm, 7 1/2°

Gefäß-Messer, Haken, Sonden  
 Vessel-Knives, Hooks, Probes  
 Bisturies, Ganchos, Sondas  
 Bisturi, Uncino, Sonde

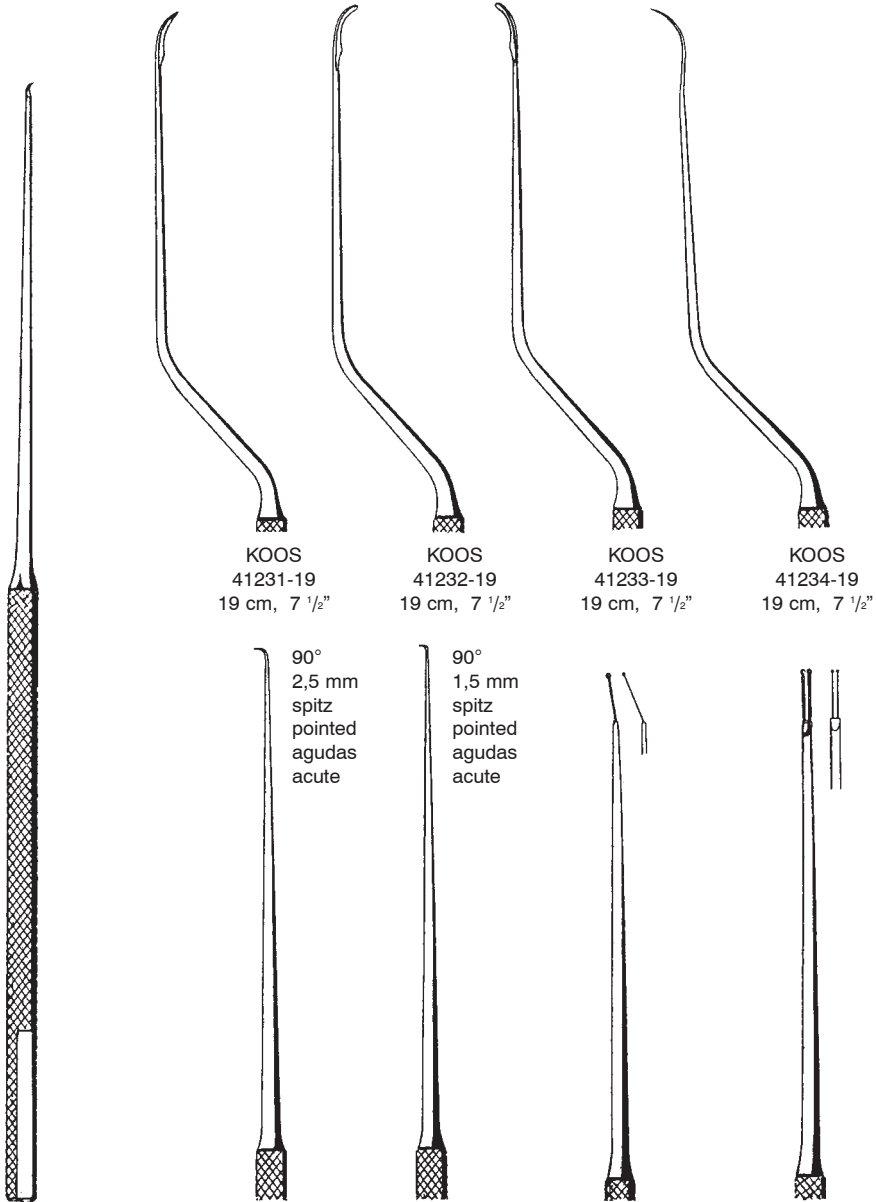

KOOS 41231-19 19 cm, 7 1/2"  
 KOOS 41232-19 19 cm, 7 1/2"  
 KOOS 41233-19 19 cm, 7 1/2"  
 KOOS 41234-19 19 cm, 7 1/2"

90° 2,5 mm spitz pointed agudas acute  
 90° 1,5 mm spitz pointed agudas acute

JACOBSON 41230-19 19 cm, 7 1/2"

FISCH 41236-19 19 cm, 7 1/2"

FISCH 41237-19 19 cm, 7 1/2"

JACOBSON 41238-19 19 cm, 7 1/2"

JACOBSON 41239-19cm 19 cm, 7 1/2"

Durahaken  
 Dura Hook  
 Ganchito para dura-madre  
 Uncino dura madre

Feines Häkchen  
 Delicate Hook  
 Ganchito muy fino  
 Uncino molto fino

Knopfsonde  
 Buttoned Probe  
 Sonda abotonada  
 Sonda bottonuta

Doppelsonde  
 Twin Probe  
 Sonda doble  
 Sonda doppia

Nervhäkchen, Hirnspatel, Saugrohre

Nerve Hooks, Brain Spatulas, Suction Tubes

Ganchos para nervios, Espatulas cerebrales, Tubos de aspiración

Uncini per nervi, Spatole cerebrali, Tubi aspirazioni



KRAYENBÜHL  
41242-19  
19 cm, 7 1/2"



KRAYENBÜHL  
41243-19  
19 cm, 7 1/2"



KRAYENBÜHL  
41244-19  
19 cm, 7 1/2"



KRAYENBÜHL  
41245-19  
19 cm, 7 1/2"

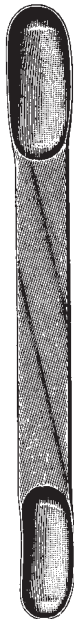

CUSHING  
18 cm, 7"

41250-11 8x10 mm  
41250-15 13x15 mm  
41250-18 16x18 mm

konkav  
concave  
cóncavo  
concavi

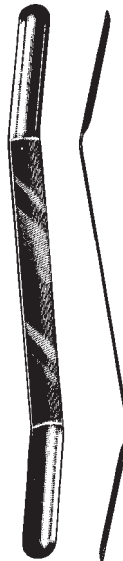

OLIVECRONA

18 cm, 7" mm  
41253-07 7/ 9  
41253-11 11/13  
41253-15 15/18  
41253-18 18/22



BARON

41299-03 3FR 1,0 mm  
41299-05 5FR 1,6 mm  
41299-07 7FR 2,3 mm

Hirnspatel, Saugrohre, Punktionskanüle  
 Brain Spatulas, Suction Tubes, Puncture Cannulas  
 Espatulas cerebrales, Tubos de aspiración, Tubo de punción  
 Spatole cerebrali, Tubi aspirazioni, cannula per punzione

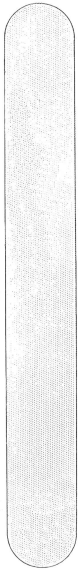

biegsam  
 malleable  
 maleable  
 malleabile

DAVIS 18 cm, 7"

- 41254-06 6 mm, 1/4"
- 41254-10 9 mm, 3/8"
- 41254-13 13 mm, 1/2"
- 41254-16 16 mm, 5/8"
- 41254-19 19 mm, 3/4"
- 41254-25 25 mm, 1"
- 41254-32 32 mm, 1 1/4"
- 41254-38 38 mm, 1 1/2"



ADSON

- 41290-21
- 21 cm, 8 1/4"
- ø 4 mm



isoliert  
 isolated  
 isolada  
 isolato

FERGUSON

- 41294-40
- 18 cm, 7"
- ø 4 mm, 90°

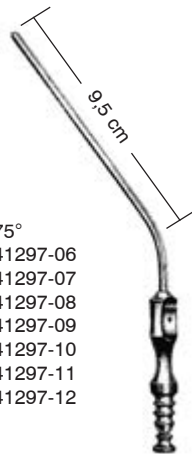

Charr.	✂		
F.G.	30°	75°	
6	41295-06	41297-06	
7	41295-07	41297-07	
8	41295-08	41297-08	
9	41295-09	41297-09	
10	41295-10	41297-10	
11	41295-11	41297-11	
12	41295-12	41297-12	
15	41295-15		

FRAZIER / FERGUSON  
 41295-06 – 41297-12  
 19 cm, 7 1/2"



FRAZIER / FERGUSON  
 41298-12  
 12 cm, 4 3/4" / 3 mm

Saugrohre  
Suction Tubes  
Tubos de aspiración  
Tubi aspirazioni

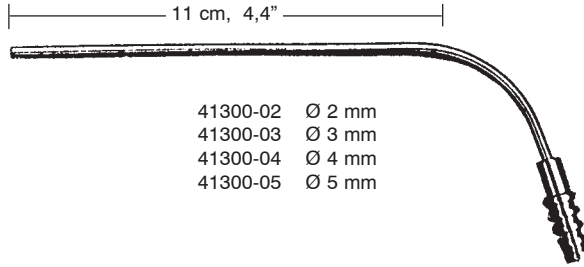

41300-02 Ø 2 mm  
41300-03 Ø 3 mm  
41300-04 Ø 4 mm  
41300-05 Ø 5 mm

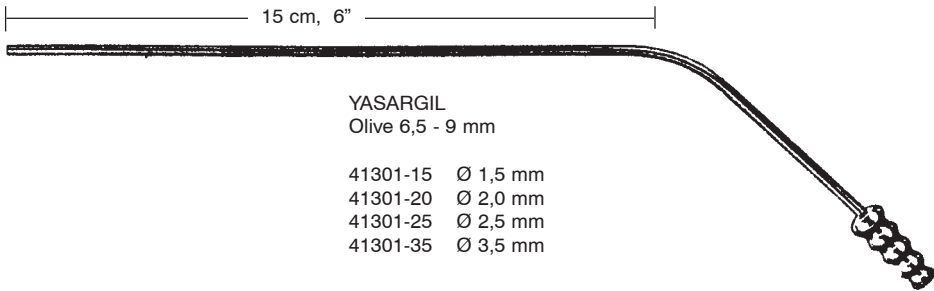

YASARGIL  
Olive 6,5 - 9 mm

41301-15 Ø 1,5 mm  
41301-20 Ø 2,0 mm  
41301-25 Ø 2,5 mm  
41301-35 Ø 3,5 mm

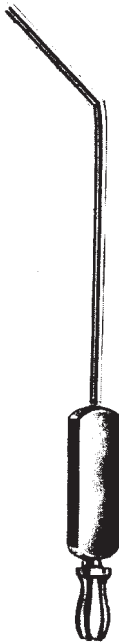

ZÖLLNER  
41302-02



0,5 mm Ø 41306-05  
0,7 mm Ø 41306-07  
0,9 mm Ø 41306-09  
1,2 mm Ø 41306-12

Kanüle für Sauggriff für ZÖLLNER und WULLSTEIN  
Tip for Suction Handle for ZÖLLNER and WULLSTEIN  
Cánula para mango t ZÖLLNER y WULLSTEIN  
Cannula per manico di aspirazione t ZÖLLNER e WULLSTEIN

Saugrohre  
Suction Tubes  
Tubos de aspiración  
Tubi aspirazioni

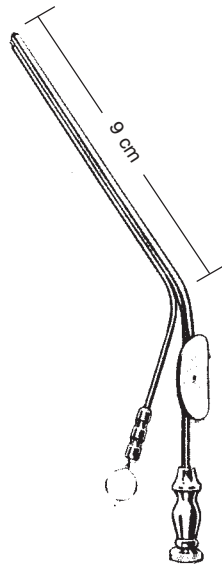

HOUSE

9 cm, 3 1/2"

41303-09	Ø 0,9 x 0,7 mm
41303-12	Ø 1,2 x 0,9 mm
41303-15	Ø 1,5 x 1,2 mm
41303-18	Ø 1,8 x 1,8 mm
41303-25	Ø 2,5 x 2,0 mm
41303-30	Ø 3,0 x 2,0 mm
41303-45	Ø 4,5 x 2,0 mm

Saugrohre, Saugkanülen  
 Suction Tubes, Suction Cannulae  
 Tubos de aspiración, Cánulas para aspiración  
 Tubi aspirazioni, Cannule per aspirazione



Sauggriff  
 Suction Handle  
 Mango de aspiración  
 Manico per aspirazione

WULLSTEIN  
 41307-00



Kanüle für Sauggriff  
 Tip for Suction Handle  
 Cánula para mango  
 Cannula per manico di aspirazione

ROSEN  
 10 cm, 4"

0,5 mm Ø	41305-05	1,2 mm Ø	41305-12
0,6 mm Ø	41305-06	1,5 mm Ø	41305-15
0,7 mm Ø	41305-07	1,8 mm Ø	41305-18
0,8 mm Ø	41305-08	2,0 mm Ø	41305-20
0,9 mm Ø	41305-09	2,5 mm Ø	41305-25
1,0 mm Ø	41305-10	3,0 mm Ø	41305-30



Charr. 6 41304-06  
 Charr. 8 41304-08  
 Charr. 10 41304-10

PLESTER  
 30°



biegsam  
 malleable  
 maleable  
 malleabile

SCHMID  
 15 cm, 6"

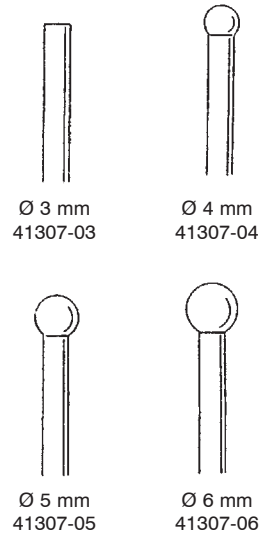



Wirbelkörperspreizer  
Lamina Spreaders  
Separadores para cuerpos vertebrales  
Divaricatori per corpi vertebrali

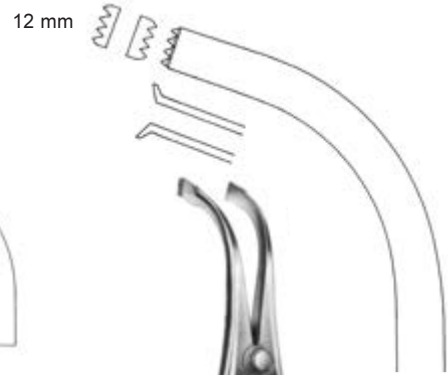

CLOWARD  
41401-16  
16 cm, 6 1/4"



INGE  
41405-17  
17 cm, 6 3/4"



INGE  
41405-27  
27 cm, 10 1/2"



19 mm

CLOWARD  
41406-01  
12,5 cm, 5"

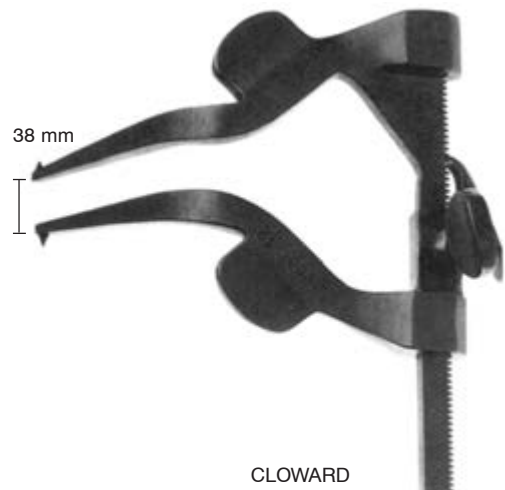

38 mm

CLOWARD  
41406-02  
7,6 cm, 3"

Laminektomie Zangen  
 Laminectomy Rongeurs  
 Pinzas cortantes para laminectomia  
 Pinze taglianti per laminectomia

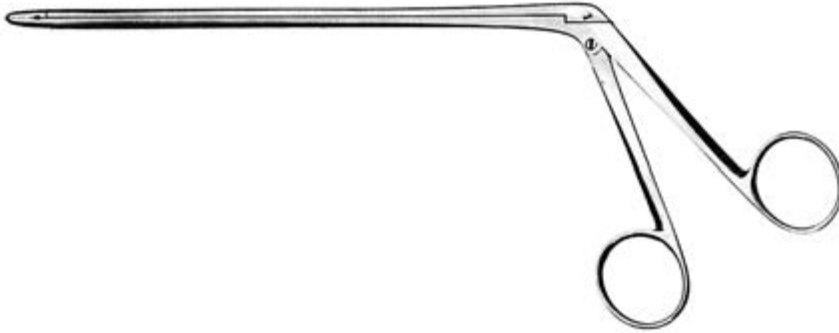

CUSHING

2 mm



2x10 mm L  
 41420-01 12,5 cm  
 41421-01 15,0 cm  
 41422-01 18,0 cm

2x10 mm/45° L  
 41420-02 12,5 cm  
 41421-02 15,0 cm  
 41422-02 18,0 cm

2x10 mm/45° L  
 41420-03 12,5 cm  
 41421-03 15,0 cm  
 41422-03 18,0 cm

LOVE-GRUENWALD

3 mm



3x10 mm L  
 41430-01 12,5 cm  
 41431-01 15,0 cm  
 41432-01 18,0 cm

3x10 mm/45° L  
 41430-02 12,5 cm  
 41431-02 15,0 cm  
 41432-02 18,0 cm

3x10 mm/45° L  
 41430-03 12,5 cm  
 41431-03 15,0 cm  
 41432-03 18,0 cm

SPURLING

4 mm

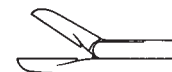

4x10 mm L  
 41440-01 12,5 cm  
 41441-01 15,0 cm  
 41442-01 18,0 cm

4x10 mm/45° L  
 41440-02 12,5 cm  
 41441-02 15,0 cm  
 41442-02 18,0 cm

4x10 mm/45° L  
 41440-03 12,5 cm  
 41441-03 15,0 cm  
 41442-03 18,0 cm

Laminektomie Zangen  
Laminectomy Rongeurs  
Pinzas cortantes para laminectomia  
Pinze taglienti per laminectomia

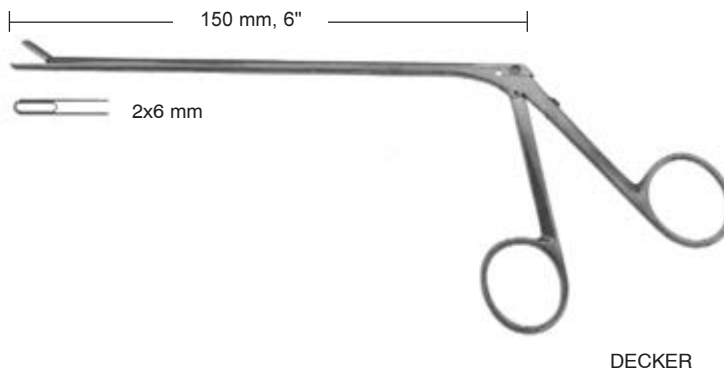
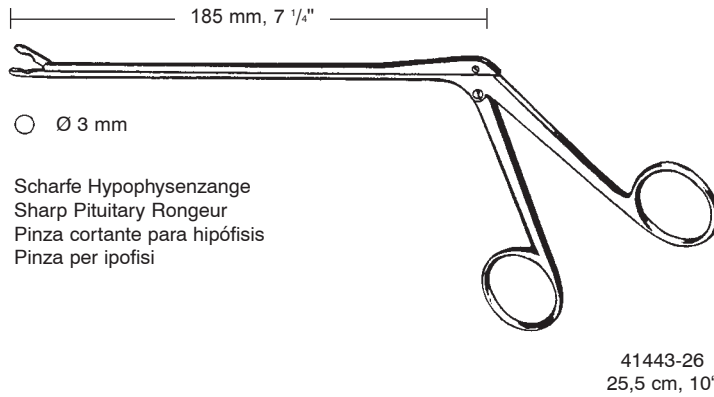

Laminektomie Zangen  
Laminectomy Rongeurs  
Pinzas cortantes para laminectomia  
Pinze taglianti per laminectomia

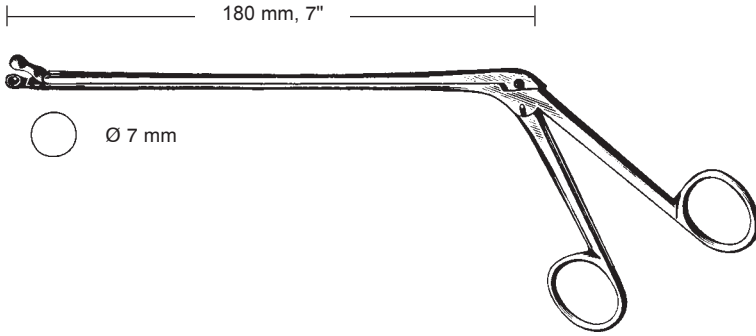

OLDBERG  
41445-25  
25 cm, 9.8"



PEAPOD  
41446-00

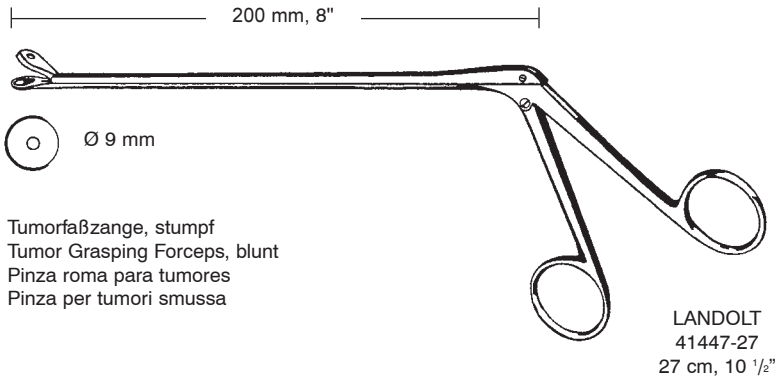

Laminektomie Zangen  
Laminectomy Rongeurs  
Pinzas cortantes para laminectomia  
Pinze taglianti per laminectomia





Laminektomie Zangen  
 Laminectomy Rongeurs  
 Pinzas cortantes para laminectomia  
 Pinze taglienti per laminectomia

150 mm, 6"

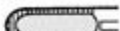
-  2 x 10 mm
-  3 x 10 mm
-  4 x 10 mm



SCHLESINGER  
 41448-02 2 x 10 mm  
 41448-03 3 x 10 mm  
 41448-04 4 x 10 mm

150 mm, 6"

3 x 10 mm

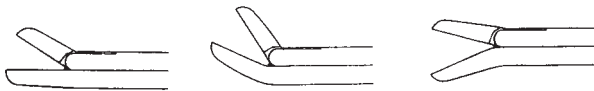

41449-01      41449-02      41449-03

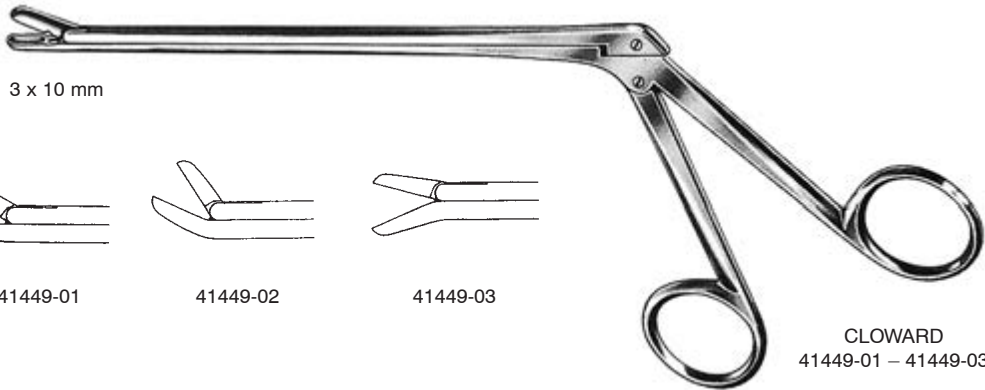

CLOWARD  
 41449-01 – 41449-03



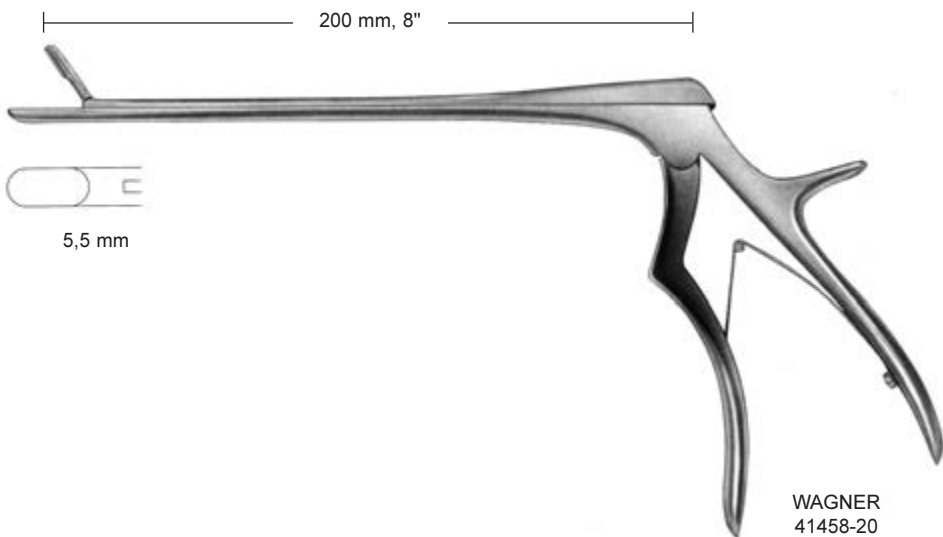
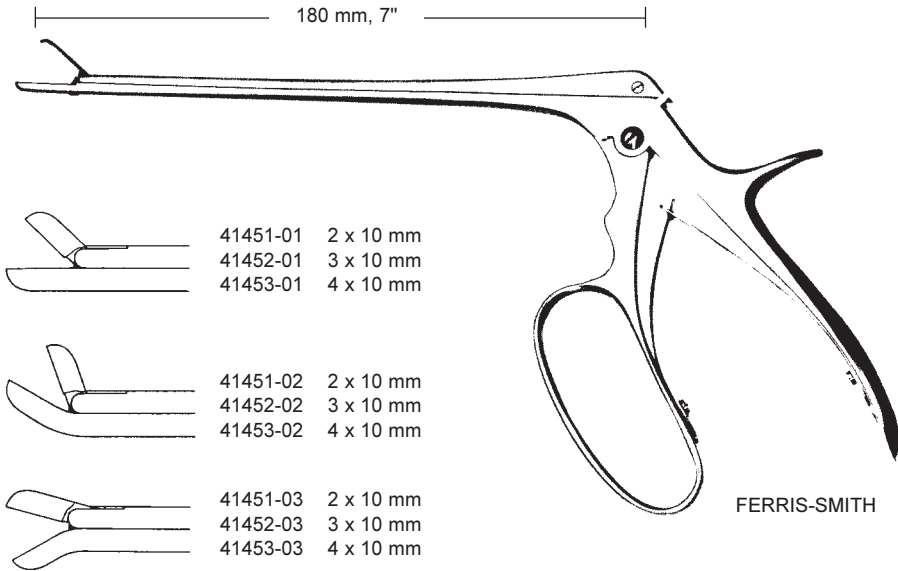

Laminektomie Zangen  
 Laminectomy Rongeurs  
 Pinzas cortantes para laminectomia  
 Pinze taglienti per laminectomia

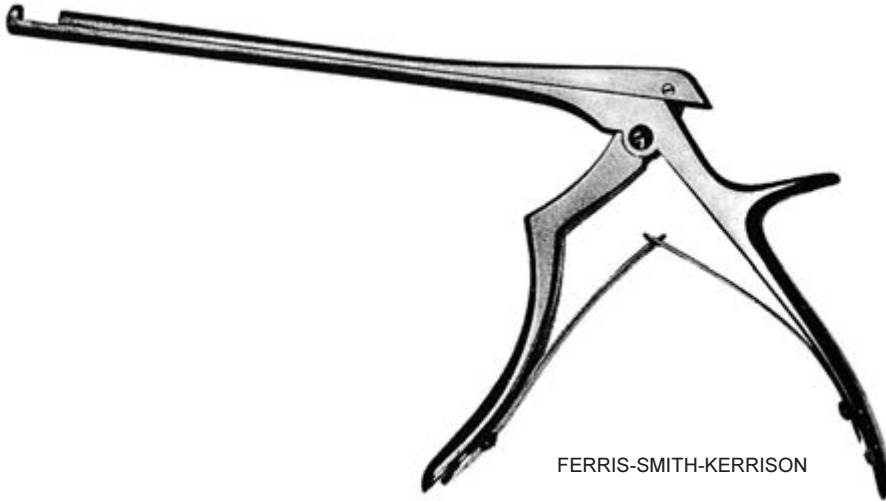

Bandscheibenstanzen  
 Intervertebral Disc Rongeurs  
 Pinzas sacabocado para discos intervertebrales  
 Pinze taglianti per dischi intervertebrali

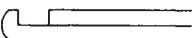
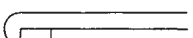
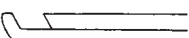
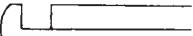
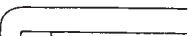
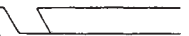
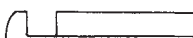
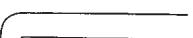

FERRIS-SMITH-KERRISON

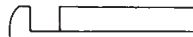
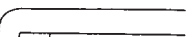
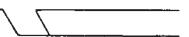
	90°	90°	40°
18 cm, 7" 20 cm, 8"	 41510-01 1 mm 41513-01 1 mm	 41511-01 1 mm 41514-01 1 mm	 41512-01 1 mm 41515-01 1 mm
18 cm, 7" 20 cm, 8"	 41510-02 2 mm 41513-02 2 mm	 41511-02 2 mm 41514-02 2 mm	 41512-02 2 mm 41515-02 2 mm
18 cm, 7" 20 cm, 8"	 41510-03 3 mm 41513-03 3 mm	 41511-03 3 mm 41514-03 3 mm	 41512-03 3 mm 41515-03 3 mm
18 cm, 7" 20 cm, 8"	 41510-04 4 mm 41513-04 4 mm	 41511-04 4 mm 41514-04 4 mm	 41512-04 4 mm 41515-04 4 mm
18 cm, 7" 20 cm, 8"	 41510-05 5 mm 41513-05 5 mm	 41511-05 5 mm 41514-05 5 mm	 41512-05 5 mm 41515-05 5 mm

auch lieferbar mit Dünnpfuß  
 also available with thin foot plate  
 tambien disponible con lámina de punzonar estrecha  
 anche disponibile con morso sottile



Bandscheibenstanzen  
Intervertebral Disc Rongeurs  
Pinzas sacabocado para discos intervertebrales  
Pinze taglianti per dischi intervertebrali

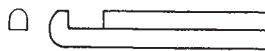
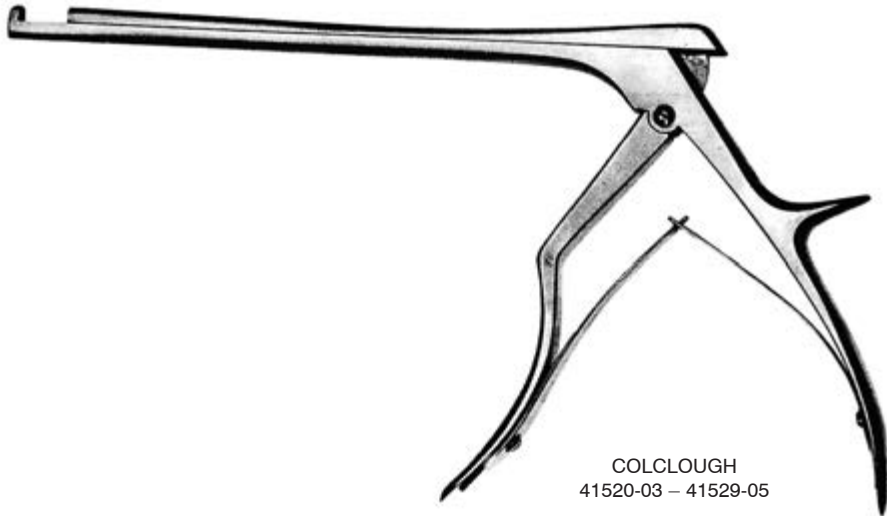

3 mm  
41520-03 15 cm, 6"  
41522-03 20 cm, 8"



5 mm  
41520-05 15 cm, 6"  
41522-05 20 cm, 8"

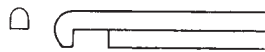

3 mm  
41524-03 15 cm, 6"  
41526-03 20 cm, 8"



5 mm  
41524-05 15 cm, 6"  
41526-05 20 cm, 8"



3 mm  
41527-03 15 cm, 6"  
41529-03 20 cm, 8"



5 mm  
41527-05 15 cm, 6"  
41529-05 20 cm, 8"

Zerlegbare Stanzen  
 Detachable punches  
 Pinzas cortantes desmontables  
 Pinze taglienti e smontabili



90°



41540-02 2 mm

41540-03 3 mm

41540-04 4 mm

41540-05 5 mm

130°



41542-02 2 mm

41542-03 3 mm

41542-04 4 mm

41542-05 5 mm

YASARGIL – Aneurysmen – Gefäß – Clips  
YASARGIL – Aneurysm – Vessel – Clips  
YASARGIL – Clips para aneurisma  
YASARGIL – Clips per aneurisma

aus hochwertigem Implantat-Stahl antimagnetisch  
in high quality Implant steel antimagnetic  
de acero inoxidable para implantes de alta calidad, antimagnético  
Prodotto in acciaio di alta qualità, antimagnetico

## Features of the Clip

### SERIAL-NUMBER

Each clip is coded with an individual serial number – marked by laser technology –  
The serial number guarantees a detailed follow-up of

- the whole production process
- the closure force
- from raw material to the final product

These informations are registered in our company for the period of 10 years.

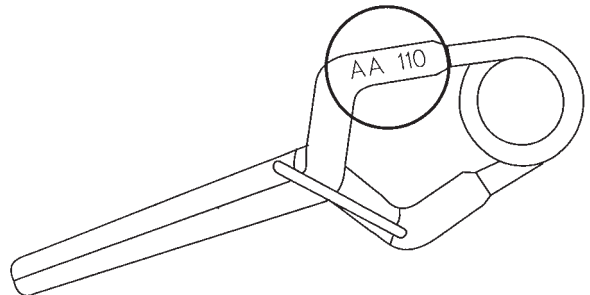

### PACKING – LABELING

Each clip is individually packaged in a transparent box made of resistant plastic.  
Special wishes of customers regarding the packaging will be considered by us. This will be marked on an internal instruction.

The transparent box is marked with a label in order to assure a quick and sure identification of the clip.

On the label you can find the following data:

- catalogue number
- Product description
- Illustration
- Closing force in g
- Tolerance range of closing force
- Blade length
- Maximum opening
- Blade geometry
- Serial number
- Jaw profile
- Material description
- Lot number
- the notes "NOT STERILE"
- WARNING

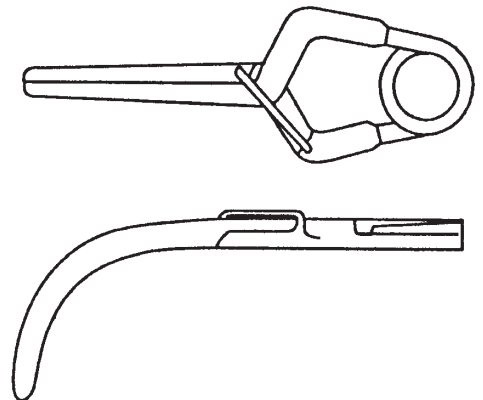

YASARGIL – Aneurysmen – Gefäß – Clips

YASARGIL – Aneurysm – Vessel – Clips

YASARGIL – Clips para aneurisma

YASARGIL – Clips per aneurisma

aus hochwertigem Implantat-Stahl antimagnetisch  
in high quality Implant steel antimagnetic  
de acero inoxidable para implantes de alta calidad, antimagnético  
Prodotto in acciaio di alta qualità, antimagnetico

## Features of the Clip

### JAW-PROFILE

The rounded, pyramid-like structure is stamped into the jaw through a special step in production and prevents sharp edged which could perforate an aneurysm

No edges or burrs through additional rounding of structures that border the clip outer side because of this, real atraumatic application of the clip

Increased surface area due to the pyramid-like design of the jaws inner surface the cross-like structure of the inner jaws pyramid surface doubles the tissue-holding area.

The applied pressure distributes itself evenly over the length of the jaw.

The convex closure of the clip assures an atraumatic and secure closure of the aneurysm.

Sliding of the clip is prevented.

### SPRING-DESIGN

The spring size, wich is different in the Standard and Mini clips, ist the same within the same type of the Clip.

Through this, the highest degree of a secure fit is ensured by the clip applier (clip/clip applier fit)

### LINK-DESIGN

Laser welded

The link ensures the precise guidance of the jaws and a "soft" opening of the clip during the whole spreading process.

The contact surface of the jaws are guided symmetrically in an exact way "over the whole lenght" this fact guarantees an additional stability of the clip.

No over-stress of the material because the design of the link limits the maximum opening width.

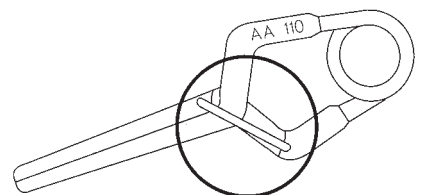
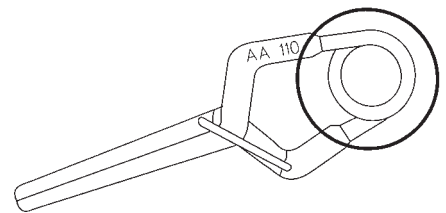
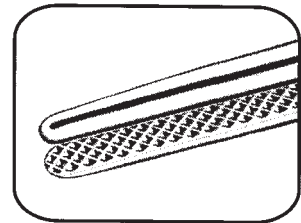
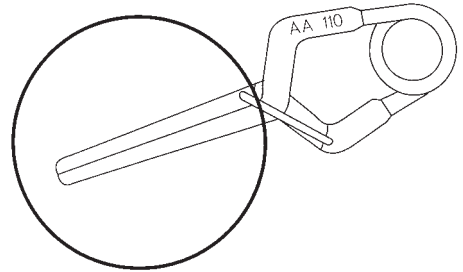

YASARGIL – Aneurysmen – Gefäß – Clips  
 YASARGIL – Aneurysm – Vessel – Clips  
 YASARGIL – Clips para aneurisma  
 YASARGIL – Clips per aneurisma

aus hochwertigem Implantat-Stahl antimagnetisch  
 in high quality Implant steel antimagnetic  
 de acero inoxidable para implantes de alta calidad, antimagnético  
 Prodotto in acciaio di alta qualità, antimagnetico

## Features of the Clip

### CLOSING-FORCE

The closing force is measured at one third of the jaw length and an opening of 0,5 mm.

The final quality control of the clip is effected by a microprocessor-controlled measuring equipment.

The closing force is indicated exactly within a certain tolerance.

By the help of a special software program we assure that before the clip passes the final quality control its closure force is fixed. As a consequence we exclude any kind of manipulation.

All relevant technical data are stored during the control procedure and printed on the label.

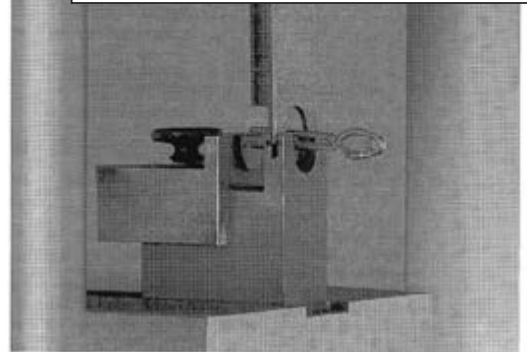
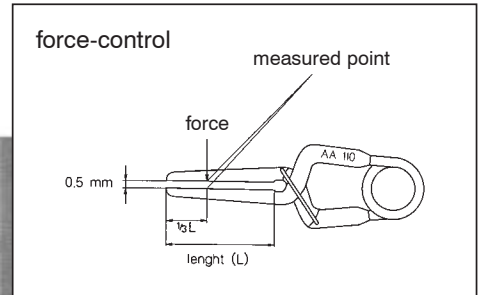

## Material and Quality Assurance

According to DIN 17445, implant steel is used in the production of our Aneurysm Clip

- High stability characteristics
- Excellent tissue compatibility
- Secure closure of blood vessels
- Antimagnetic
- Ideally suited as implantation material
- Security against over straining



YASARGIL – Aneurysmen – Gefäß – Clips  
 YASARGIL – Aneurysm – Vessel – Clips  
 YASARGIL – Clips para aneurisma  
 YASARGIL – Clips per aneurisma

aus hochwertigem Implantat-Stahl antimagnetisch  
 in high quality Implant steel antimagnetic  
 de acero inoxidable para implantes de alta calidad, antimagnético  
 Prodotto in acciaio di alta qualità, antimagnetico

YASARGIL-STANDARD für permanenten Verschluss  
 YASARGIL-STANDARD for permanent closure  
 YASARGIL-STANDARD para cierre permanente  
 YASARGIL-STANDARD con chiusura permanente

**Standard**

Cat. Nr.	41600-62	41600-70	41600-78	41600-92	41601-10	41601-11
	<b>41600-62 T</b>	<b>41600-70 T</b>	<b>41600-78 T</b>	<b>41600-92 T</b>	<b>41601-10 T</b>	<b>41601-11 T</b>
max. opening	6,2 mm	7,0 mm	7,8 mm	9,2 mm	10,6 mm	11,4 mm
Force	150 gms	180 gms	180 gms	200 gms	200 gms	200 gms
	41601-13	41602-60	41602-68	41602-75	41602-87	41603-55
	<b>41601-13 T</b>	<b>41602-60 T</b>	<b>41602-68 T</b>	<b>41602-75 T</b>	<b>41602-87 T</b>	<b>41603-55 T</b>
	13,3 mm	6,0 mm	6,8 mm	7,5 mm	8,7 mm	5,5 mm
	200 gms	150 gms	180 gms	180 gms	200 gms	150 gms
	41603-61	41603-65	41603-74	41604-54	41604-58	41604-62
	<b>41603-61 T</b>	<b>41603-65 T</b>	<b>41603-74 T</b>	<b>41604-54 T</b>	<b>41604-58 T</b>	<b>41604-62 T</b>
	6,1 mm	6,5 mm	7,4 mm	5,4 mm	5,8 mm	6,2 mm
	180 gms	180 gms	200 gms	180 gms	180 gms	200 gms
	41604-79	41604-87				
	<b>41604-79 T</b>	<b>41604-87 T</b>				
	7,9 mm	8,7 mm				
	200 gms	200 gms				

YASARGIL – Aneurysmen – Gefäß – Clips

YASARGIL – Aneurysm – Vessel – Clips

YASARGIL – Clips para aneurisma

YASARGIL – Clips per aneurisma

aus hochwertigem Implantat-Stahl antimagnetisch  
in high quality Implant steel antimagnetic  
de acero inoxidable para implantes de alta calidad, antimagnético  
Prodotto in acciaio di alta qualità, antimagnetico

YASARGIL-STANDARD für permanenten Verschluss

YASARGIL-STANDARD for permanent closure

YASARGIL-STANDARD para cierre permanente

YASARGIL-STANDARD con chiusura permanente

## Standard

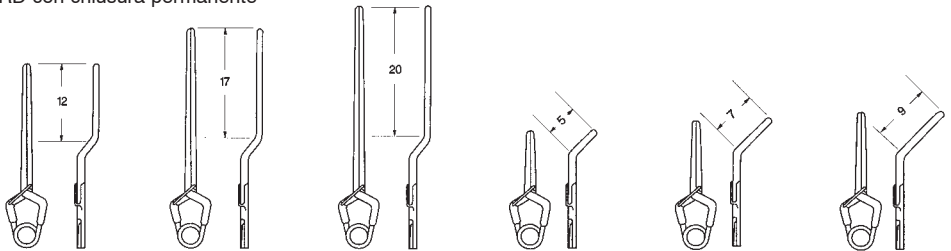

Cat. Nr.	41605-10	41605-12	41605-13	41606-62	41606-65	41606-78
	<b>41605-10 T</b>	<b>41605-12 T</b>	<b>41605-13 T</b>	<b>41606-62-T</b>	<b>41606-65 T</b>	<b>41606-78 T</b>
max. opening	10,2 mm	11,9 mm	13,0 mm	6,2 mm	6,5 mm	7,8 mm
Force	200 gms	180 gms	180 gms	200 gms	200 gms	200 gms

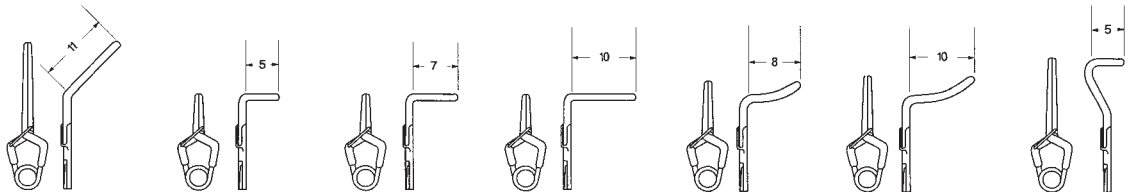

	<b>41606-84 T</b>	<b>41607-56 T</b>	<b>41607-57 T</b>	<b>41607-58 T</b>	<b>41607-59 T</b>	<b>41607-60 T</b>	<b>41607-72 T</b>
	8,4 mm	5,6 mm	5,6 mm	5,6 mm	5,4 mm	5,6 mm	7,2 mm
	200 gms	200 gms	200 gms	200 gms	200 gms	200 gms	200 gms

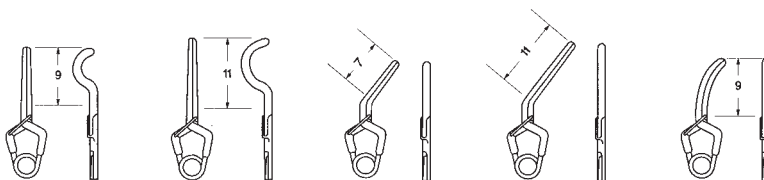

	<b>41607-73 T</b>	<b>41607-82 T</b>	<b>41608-57 T</b>	<b>41608-80 T</b>	<b>41609-70 T</b>
	7,2 mm	8,2 mm	5,7 mm	8,0 mm	7,0 mm
	200 gms	200 gms	200 gms	200 gms	200 gms



YASARGIL – Aneurysmen – Gefäß – Clips  
 YASARGIL – Aneurysm – Vessel – Clips  
 YASARGIL – Clips para aneurisma  
 YASARGIL – Clips per aneurisma

aus hochwertigem Implantat-Stahl antimagnetisch  
 in high quality Implant steel antimagnetic  
 de acero inoxidable para implantes de alta calidad, antimagnético  
 Prodotto in acciaio di alta qualità, antimagnetico

YASARGIL-STANDARD für temporären Verschluss  
 YASARGIL-STANDARD for temporary closure  
 YASARGIL-STANDARD para cierre temporal  
 YASARGIL-STANDARD con chiusura temporanea

### Standard

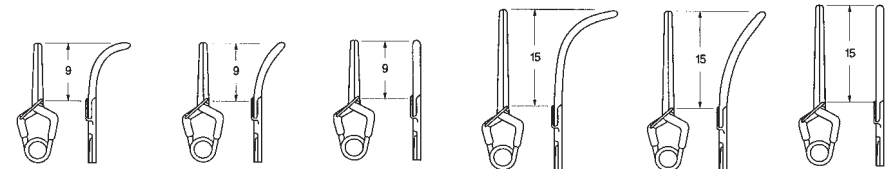

Cat. Nr.	41610-61 <b>41610-61 T</b>	41610-68 <b>41610-68 T</b>	41610-70 <b>41610-70 T</b>	41611-74 <b>41611-74 T</b>	41611-87 <b>41611-87 T</b>	41611-92 <b>41611-92 T</b>
max. opening	6,1 mm	6,8 mm	7,0 mm	7,4 mm	8,7 mm	9,2 mm
Force	70 gms	70 gms	70 gms	70 gms	70 gms	70 gms

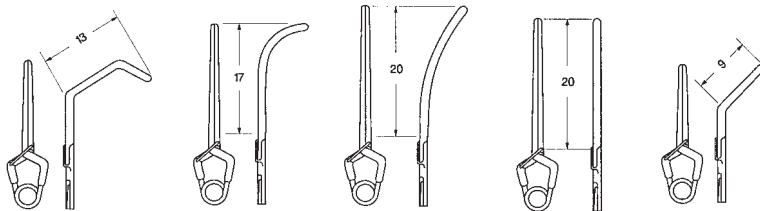

41612-07 <b>41612-07 T</b>	41612-09 <b>41612-09 T</b>	41612-11 <b>41612-11 T</b>	41612-12 <b>41612-12 T</b>	41612-62 <b>41612-62 T</b>
7,5 mm	9,9 mm	11,0 mm	11,4 mm	6,2 mm
90 gms	90 gms	90 gms	90 gms	70 gms

YASARGIL – Aneurysmen – Gefäß – Clips

YASARGIL – Aneurysm – Vessel – Clips

YASARGIL – Clips para aneurisma

YASARGIL – Clips per aneurisma

aus hochwertigem Implantat-Stahl antimagnetisch  
in high quality Implant steel antimagnetic  
de acero inoxidable para implantes de alta calidad, antimagnético  
Prodotto in acciaio di alta qualità, antimagnetico

YASARGIL-STANDARD für permanenten Verschluss

YASARGIL-STANDARD for permanent closure

YASARGIL-STANDARD para cierre permanente

YASARGIL-STANDARD con chiusura permanente

## Standard

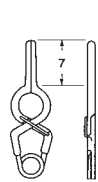

Cat. Nr. 41613-74  
**41613-74 T**  
max. opening 7,4 mm  
Force 150 gms

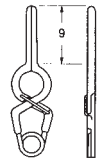

Cat. Nr. 41613-84  
**41613-84 T**  
max. opening 8,4 mm  
Force 150 gms

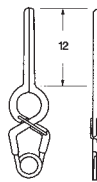

Cat. Nr. 41613-96  
**41613-96 T**  
max. opening 9,6 mm  
Force 180 gms

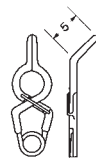

Cat. Nr. 41614-58  
**41614-58 T**  
max. opening 5,8 mm  
Force 150 gms

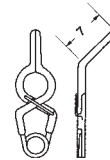

Cat. Nr. 41614-65  
**41614-65 T**  
max. opening 6,5 mm  
Force 150 gms

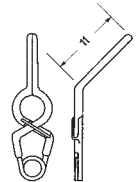

Cat. Nr. 41614-72  
**41614-72 T**  
max. opening 7,2 mm  
Force 180 gms

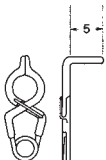

Cat. Nr. 41615-49  
**41615-49 T**  
max. opening 4,9 mm  
Force 150 gms

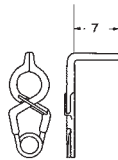

Cat. Nr. 41615-50  
**41615-50 T**  
max. opening 4,9 mm  
Force 150 gms

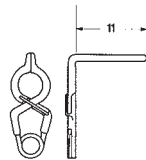

Cat. Nr. 41615-51  
**41615-51 T**  
max. opening 4,9 mm  
Force 180 gms

YASARGIL – Aneurysmen – Gefäß – Clips  
 YASARGIL – Aneurysm – Vessel – Clips  
 YASARGIL – Clips para aneurisma  
 YASARGIL – Clips per aneurisma

aus hochwertigem Implantat-Stahl antimagnetisch  
 in high quality Implant steel antimagnetic  
 de acero inoxidable para implantes de alta calidad, antimagnético  
 Prodotto in acciaio di alta qualità, antimagnetico

YASARGIL-STANDARD für permanenten Verschluss  
 YASARGIL-STANDARD for permanent closure  
 YASARGIL-STANDARD para cierre permanente  
 YASARGIL-STANDARD con chiusura permanente

## Standard

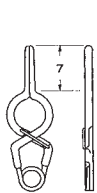

Cat. Nr. 41616-79  
**41616-79 T**  
 max. opening 7,9 mm  
 Force 150 gms

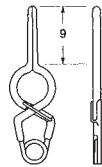

Cat. Nr. 41616-91  
**41616-91 T**  
 max. opening 9,1 mm  
 Force 150 gms

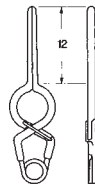

Cat. Nr. 41617-10  
**41617-10 T**  
 max. opening 10,3 mm  
 Force 180 gms

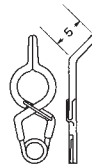

Cat. Nr. 41617-65  
**41617-65 T**  
 max. opening 6,5 mm  
 Force 150 gms

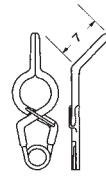

Cat. Nr. 41617-72  
**41617-72 T**  
 max. opening 7,2 mm  
 Force 150 gms

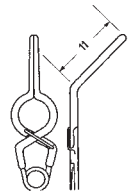

Cat. Nr. 41617-78  
**41617-78 T**  
 max. opening 7,8 mm  
 Force 180 gms

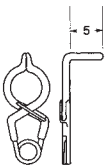

Cat. Nr. 41618-55  
**41618-55 T**  
 max. opening 5,5 mm  
 Force 150 gms

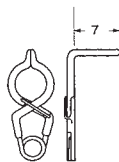

Cat. Nr. 41618-56  
**41618-56 T**  
 max. opening 5,5 mm  
 Force 150 gms

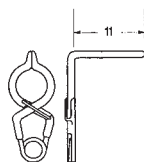

Cat. Nr. 41618-57  
**41618-57 T**  
 max. opening 5,5 mm  
 Force 180 gms

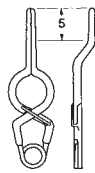

Cat. Nr. 41618-79  
**41618-79 T**  
 max. opening 7,9 mm  
 Force 150 gms

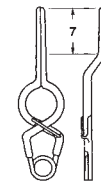

Cat. Nr. 41618-88  
**41618-88 T**  
 max. opening 8,8 mm  
 Force 150 gms

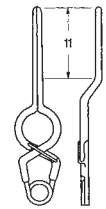

Cat. Nr. 41619-00  
**41619-00 T**  
 max. opening 10,0 mm  
 Force 180 gms

YASARGIL – Aneurysmen – Gefäß – Clips

YASARGIL – Aneurysm – Vessel – Clips

YASARGIL – Clips para aneurisma

YASARGIL – Clips per aneurisma

aus hochwertigem Implantat-Stahl antimagnetisch  
in high quality Implant steel antimagnetic  
de acero inoxidable para implantes de alta calidad, antimagnético  
Prodotto in acciaio di alta qualità, antimagnetico

YASARGIL-STANDARD für permanenten Verschluss

YASARGIL-STANDARD for permanent closure

YASARGIL-STANDARD para cierre permanente

YASARGIL-STANDARD con chiusura permanente

## Standard

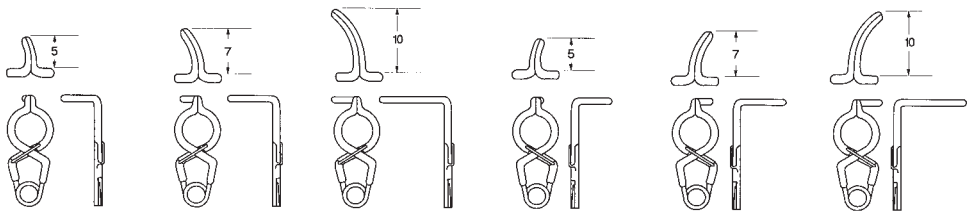

Cat. Nr.	41620-58	41620-59	41620-60	41620-61	41620-62	41620-63
	<b>41620-58 T</b>	<b>41620-59 T</b>	<b>41620-60 T</b>	<b>41620-61 T</b>	<b>41620-62 T</b>	<b>41620-63 T</b>
max. opening	5,8 mm	5,8 mm	5,8 mm	5,8 mm	5,8 mm	5,8 mm
Force	150 gms	150 gms	150 gms	150 gms	150 gms	150 gms

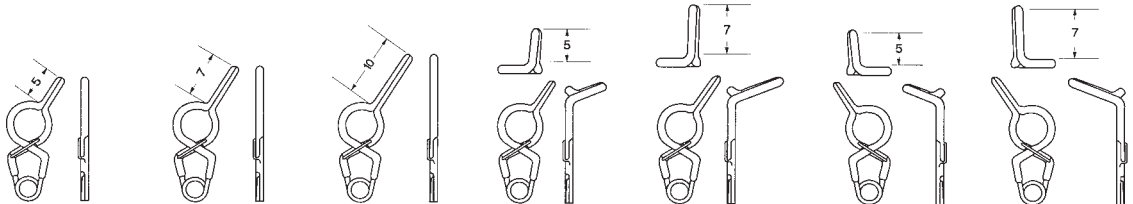

	41620-70	41620-78	41620-88	41621-58	41621-62	41622-58	41622-62
	<b>41620-70 T</b>	<b>41620-78 T</b>	<b>41620-88 T</b>	<b>41621-58 T</b>	<b>41621-62 T</b>	<b>41622-58 T</b>	<b>41622-62 T</b>
	7,0 mm	7,8 mm	8,8 mm	5,8 mm	6,2 mm	5,8 mm	6,2 mm
	150 gms	150 gms	150 gms	150 gms	150 gms	150 gms	150 gms

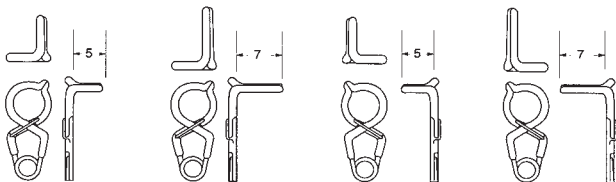

	41623-56	41624-56	41625-56	41626-56
	<b>41623-56 T</b>	<b>41624-56 T</b>	<b>41625-56 T</b>	<b>41626-56 T</b>
	5,6 mm	5,6 mm	5,6 mm	5,6 mm
	150 gms	150 gms	150 gms	150 gms

YASARGIL – Aneurysmen – Gefäß – Clips  
 YASARGIL – Aneurysm – Vessel – Clips  
 YASARGIL – Clips para aneurisma  
 YASARGIL – Clips per aneurisma

aus hochwertigem Implantat-Stahl antimagnetisch  
 in high quality Implant steel antimagnetic  
 de acero inoxidable para implantes de alta calidad, antimagnético  
 Prodotto in acciaio di alta qualità, antimagnetico

YASARGIL-STANDARD für permanenten Verschluss  
 YASARGIL-STANDARD for permanent closure  
 YASARGIL-STANDARD para cierre permanente  
 YASARGIL-STANDARD con chiusura permanente

Mini

Cat. Nr.	41627-33	41627-40	41628-33	41628-40	41628-46	41629-32
	<b>41627-33 T</b>	<b>41627-40 T</b>	<b>41628-33 T</b>	<b>41628-40 T</b>	<b>41628-46 T</b>	<b>41629-32 T</b>
max. opening	3,3 mm	4,0 mm	3,3 mm	4,0 mm	4,6 mm	3,2 mm
Force	110 gms	110 gms	110 gms	110 gms	110 gms	110 gms
	41629-38	41630-36	41630-38	41631-36	41631-40	41631-44
	<b>41629-38 T</b>	<b>41630-36 T</b>	<b>41630-38 T</b>	<b>41631-36 T</b>	<b>41631-40 T</b>	<b>41631-44 T</b>
	3,8 mm	3,6 mm	3,8 mm	3,6 mm	4,0 mm	4,4 mm
	110 gms	110 gms	110 gms	110 gms	110 gms	110 gms
	41633-35	41633-40	41634-35	41634-60	41634-70	41635-57
	<b>41633-35 T</b>	<b>41633-40 T</b>	<b>41634-35 T</b>	<b>41634-60 T</b>	<b>41634-70 T</b>	<b>41635-57 T</b>
	3,5 mm	4,0 mm	3,5 mm	6,0 mm	7,0 mm	5,7 mm
	110 gms	110 gms	130 gms	130 gms	130 gms	130 gms
	41636-45					
	<b>41636-45 T</b>					
	4,5 mm					
	130 gms					



YASARGIL – Aneurysmen – Gefäß – Clips

YASARGIL – Aneurysm – Vessel – Clips

YASARGIL – Clips para aneurisma

YASARGIL – Clips per aneurisma

aus hochwertigem Implantat-Stahl antimagnetisch  
 in high quality Implant steel antimagnetic  
 de acero inoxidable para implantes de alta calidad, antimagnético  
 Prodotto in acciaio di alta qualità, antimagnetico

YASARGIL-STANDARD für temporären Verschuß

YASARGIL-STANDARD for temporary closure

YASARGIL-STANDARD para cierre temporal

YASARGIL-STANDARD con chiusura temporanea

## Mini

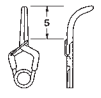

Cat. Nr.	41637-33	41637-40	41638-38	41638-46	41639-44	41640-40
	<b>41637-33 T</b>	<b>41637-40 T</b>	<b>41638-38 T</b>	<b>41638-46 T</b>	<b>41639-44 T</b>	<b>41640-40 T</b>
max. opening	3,3 mm	4,0 mm	3,8 mm	4,6 mm	4,4 mm	4,0 mm
Force	50 gms	50 gms	50 gms	70 gms	70 gms	70 gms

Anlegezange mit Rundgriff – FLEXIBEL – mit und ohne drehbarem Maulteil  
 Applying forceps with round shaft – FLEXIBLE – with and without Rotation  
 Pinzas de aplicación con mango redondo – FLEXIBLE – con y sin rotación  
 Posa clips con manico rotonda guaina FLESSIBILE cover sistema rotante ed non rotante

Länge		
Length		
Largo		
Lunghezza	MINI	STANDARD
70 mm	41641-07	41643-07
90 mm	41641-09	41643-09
110 mm	41641-11	41643-11

nicht drehbar  
 non rotating  
 sin rotación  
 non rotante

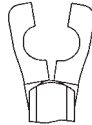

Länge		
Length		
Largo		
Lunghezza	MINI	STANDARD
70 mm	41642-07	41644-07
90 mm	41642-09	41644-09
110 mm	41642-11	41644-11

drehbar  
 rotating  
 rotante  
 rotante

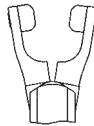

Beispiel für Drehmechanismus  
 Example for Rotation  
 Ejemplo de la rotación  
 Esempio della rotazione

Clips drehbar im Maul  
 Clips rotabile in jaw  
 Clips rotabile en la boca  
 Clips rotabile nel morso

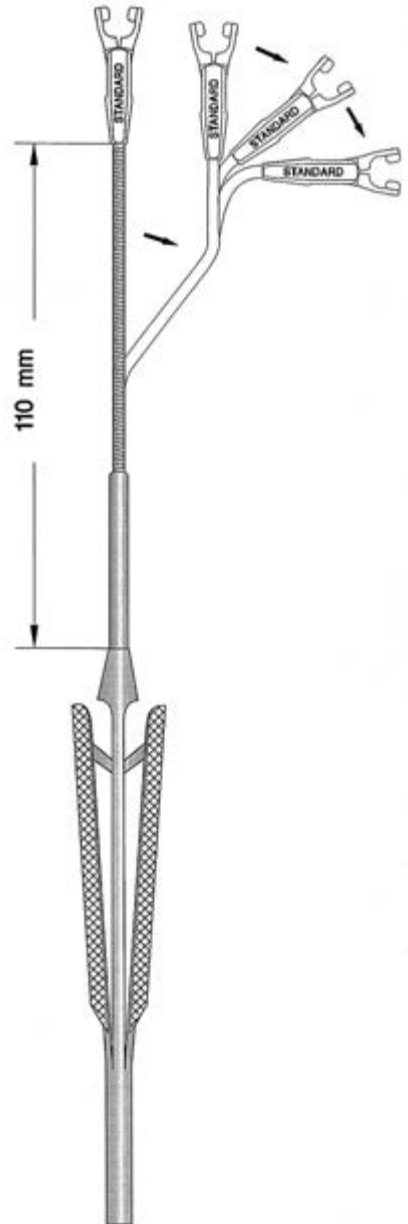
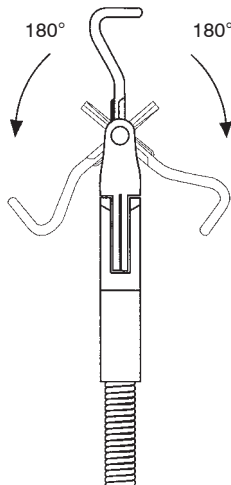

41641-07 - 41644-11



Anlegezange mit Rundgriff – starr – mit und ohne drehbarem Maulteil  
 Applying forceps with round shaft – rigid – with and without Rotation  
 Pinzas de aplicación con mango redondo – rigido – con y sin rotación  
 Posa clips con manico rotonda guaina rigida cover sistema rotante ed non rotante

Länge			nicht drehbar
Length			non rotating
Largo			sin rotación
Lunghezza	MINI	STANDARD	non rotante
70 mm	41645-07	41647-07	
90 mm	41645-09	41647-09	
110 mm	41645-11	41647-11	

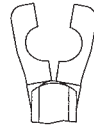

Länge			drehbar
Length			rotating
Largo			rotante
Lunghezza	MINI	STANDARD	rotante
70 mm	41646-07	41648-07	
90 mm	41646-09	41648-09	
110 mm	41646-11	41648-11	

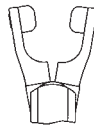

drehbar  
rotating  
rotante  
rotante

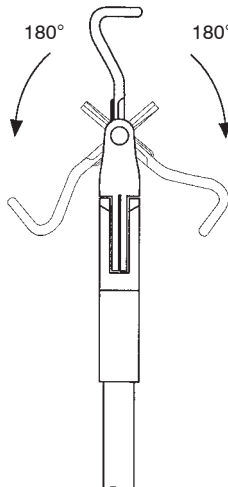

Beispiel für Drehmechanismus  
 Example for Rotation  
 Ejemplo de la rotación  
 Esempio della rotazione

Clips drehbar im Maul  
 Clips rotabile in jaw  
 Clips rotabile en la boca  
 Clips rotabile nel morso

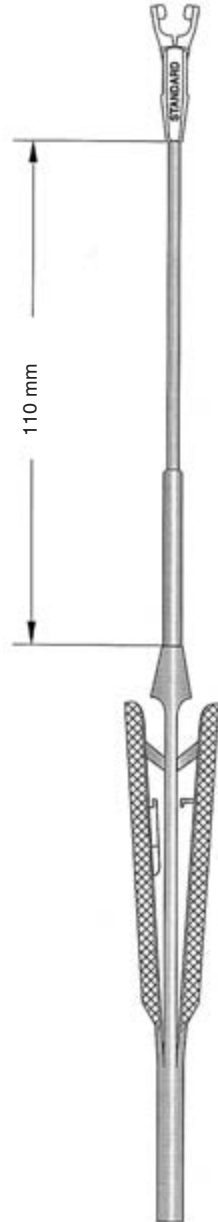

41645-07 - 41648-11



Anlegezange mit Rundgriff – starr – mit und ohne drehbarem Maulteil  
 Applying forceps with round shaft – rigid – with and without Rotation  
 Pinzas de aplicación con mango redondo – rigido – con y sin rotación  
 Posa clips con manico rotonda guaina rigida cover sistema rotante ed non rotante

Länge		
Length		
Largo		
Lunghezza	MINI	STANDARD
70 mm	41649-07	41651-07
90 mm	41649-09	41651-09
110 mm	41649-11	41651-11

nicht drehbar  
 non rotating  
 sin rotación  
 non rotante

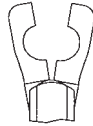

Länge		
Length		
Largo		
Lunghezza	MINI	STANDARD
70 mm	41650-07	41652-07
90 mm	41650-09	41652-09
110 mm	41650-11	41652-11

drehbar  
 rotating  
 rotante  
 rotante

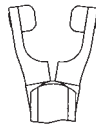

drehbar  
 rotating  
 rotante  
 rotante

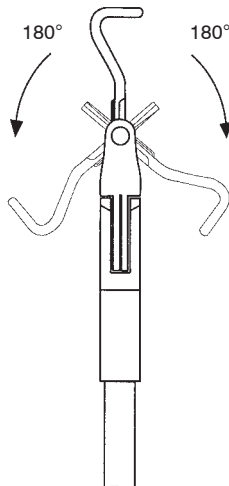

Beispiel für Drehmechanismus  
 Example for Rotation  
 Ejemplo de la rotación  
 Esempio della rotazione

Clips drehbar im Maul  
 Clips rotabile in jaw  
 Clips rotabile en la boca  
 Clips rotabile nel morso

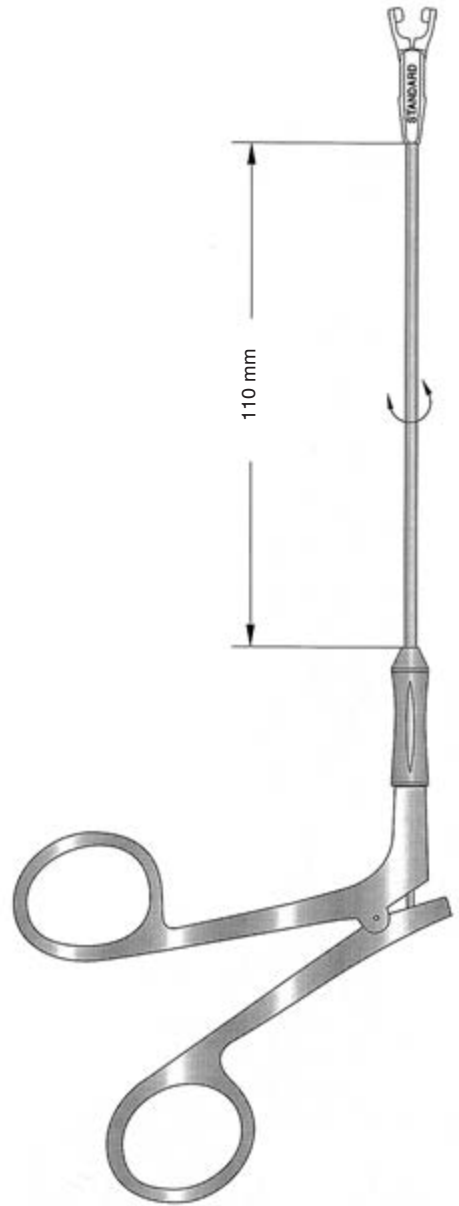

41649-07 - 41652-11

Anlegezange – mit und ohne drehbarem Maulteil  
 Applying Forceps – with and without Rotation  
 Pinzas de aplicación, con y sin rotación  
 Pinza posa clips, con ed senza rotazione

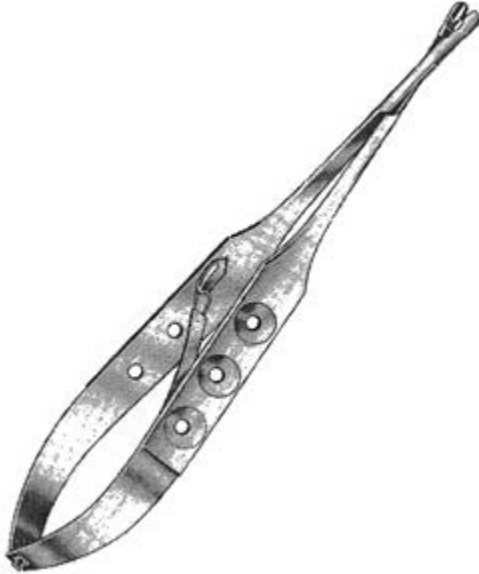

MINI	41653-18	
STANDARD	41654-18	
MINI	41655-18	drehbar / rotating rotante / rotante
STANDARD	41656-18	drehbar / rotating rotante / rotante

Anlegezange gerade, mit Sperre, Länge 18 cm, 7"  
 Applying Forceps straight, with Ratchet, Length 18 cm, 7"  
 Pinza de aplicación, con cremallera, 18 cm, 7"  
 Posa clips, retta con bloccaggio lunghezza 18 cm, 7"





Länge			
Length			
Largo			
Lunghezza	17 cm, 6 <sup>3</sup> / <sub>4</sub> "	21 cm, 8 <sup>1</sup> / <sub>4</sub> "	23 cm, 9"
MINI	41657-17	41657-21	41657-23
STANDARD	41658-17	41658-21	41658-23
MINI	41659-17	41659-21	41659-23
	drehbar / rotating / rotante / rotante		
STANDARD	41660-17	41660-21	41660-23
	drehbar / rotating / rotante / rotante		

Clips drehbar im Maul  
 Clips rotabile in jaw  
 Clips rotabile en la boca  
 Clips rotabile nel morso

Anlegezange bayonett, mit Sperre  
 Applying Forceps bajonett, with Ratchet  
 Pinza de aplicación bayoneta, con cremallera  
 Posa clips a baionetta con bloccaggio

Gefäßclips nach BIEMER  
 BIEMER Vessel Clips  
 Clips para vasos de BIEMER  
 Clips per vasi secondo BIEMER

	Maulöffnung Opening	Maullänge Length of jaws	Schließkraft Closing Force
 41661-40	Apertura de la boca Apertura del morso 4,0 mm	Largo de la boca Lunghhezza del morso 6,0 mm	Fuerza del cierre Forza di chiusura 30 - 40 g (0,29 - 0,39 N)
 41661-50	5,0 mm	9,0 mm	30 - 40 g (0,29 - 0,39 N)
 41662-50	5,0 mm	9,0 mm	20 - 25 g (0,20 - 0,25 N)

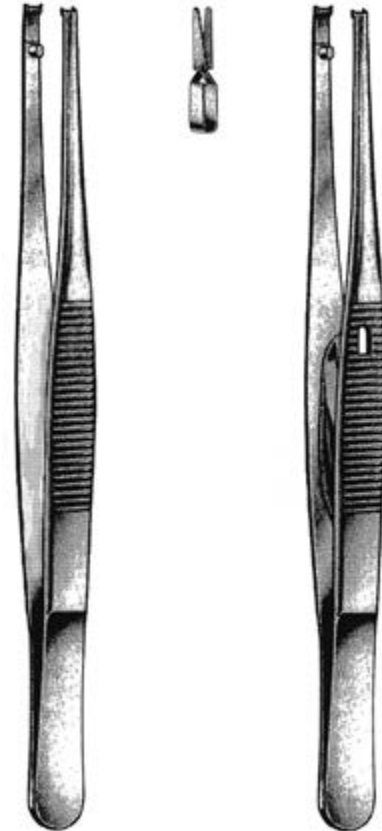

für temporären Gebrauch

gekennzeichnet durch gelb eingefärbte Federenden für Gefäße mit einem Durchmesser 0,5 - 2,0 mm

Maulinnenflächen schräg gerieft für schonendes, sicheres Festhalten der Gefäße

Der fest eingestellte Schließdruck gewährt risikofreie Anwendung

for temporary occlusion

(identified by yellow coloured spring ends) for vessel diam. 0,5 - 2,0 mm

Blade gripping surface with oblique serrations for save but careful gripping of vessels

No risk due to rigidly fixed pressure measure

para uso temporal

clips marcados con baño dorado en los resortes, para vasos con un diámetro de 0,5 - 2,0 mm

El interior de las quijadas viene con estrias finas para un agarre seguro y cuidadoso de los vasos

Debido a la calibración exacta de la fuerza de cierre se ofrece una aplicación sin riesgo

per chiusura temporanea

per vasi con Diametro 0,5 - 2,0 mm

La chiusura regolata garantisce nessun rischio

BIEMER  
41663-01

Anlegepinzette ohne Schloß,  
für Mikro-Gefäßclips  
41661-40 - 41662-50  
und  
Approximatoren  
41667-30 - 41670-50  
und  
41672-01 - 41672-04

Applying forceps without lock.  
for vessel clips  
41661-40 - 41662-50  
and  
Aproximators  
41667-30 - 41670-50  
and  
41672-01 - 41672-04

BIEMER  
41663-02

Anlegepinzette mit Schloß,  
für Mikro-Gefäßclips  
41661-40 - 41662-50  
und  
Approximatoren  
41667-30 - 41670-50  
und  
41672-01 - 41672-04

Applying forceps with lock.  
for vessel clips  
41661-40 - 41662-50  
and  
Aproximators  
41667-30 - 41670-50  
and  
41672-01 - 41672-04

Gefäßclips nach MEHDORN  
MEHDORN Vessel Clips  
Clips para vasos de MEHDORN  
Clips secondo MEHDORN

für temporären Gebrauch

gekennzeichnet durch gelb eingefärbte Federenden für Gefäße mit einem Durchmesser 0,5 - 1,5 mm

Maulinnenflächen schräg gerieft für schonendes, sicheres Festhalten der Gefäße

Der fest eingestellte Schließdruck gewährt risikofreie Anwendung

for temporary occlusion

(identified by yellow coloured spring ends) for vessel diam. 0,5 - 1,5 mm

Blade gripping surface with oblique serrations for save but careful gripping of vessels

No risk due to rigidly fixed pressure measure

Beispiele für die variable Position des Clips  
Ejemplo para la variedad de la aplicación del clip  
Esempio: posizioni variabili delle clips

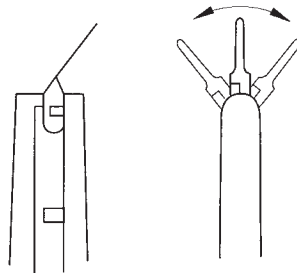

para uso temporal

clips marcados con baño dorado en los resortes, para vasos con un diámetro de 0,5 - 1,5 mm

El interior de las quijadas viene con estrias finas para un agarre seguro y cuidadoso de los vasos





Debido a la calibración exacta de la fuerza de cierre se ofrece una aplicación sin riesgo

per chiusura temporanea

per vasi con Diametro 0,5 - 1,5 mm

La chiusura regolata garantisce nessun rischio

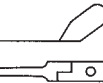

	Maullänge Length of jaws Largo de la boca Lunghezza del morso	Schließkraft Closing Force Fuerza del cierre Forza di chiusura	MEHDORN 41666-00
	41664-10 4 x 1,0 mm	10 - 15 g (0,10 - 0,15 N)	Anlegepinzette für Mikro-Gefäßclips 41664-10 - 41665-14
	41664-14 4 x 1,4 mm	15 - 20 g (0,15 - 0,20 N)	Applying Forceps for vessel clips 41664-10 - 41665-14
	41665-10 6 x 1,0 mm	10 - 15 g (0,10 - 0,15 N)	Pinza de aplicación para micro-clips 41664-10 - 41665-14
	41665-14 6 x 1,4 mm	15 - 20 g (0,15 - 0,20 N)	Pinza posa clips per microvasi 41664-10 - 41665-14

Approximatoren nach Biemer-Müller  
 Approximators Biemer-Müller  
 Aproximadores de Biemer-Müller  
 Approssimatore secondo Biemer-Müller

**für temporären Gebrauch**

gekennzeichnet durch gelb eingefärbte Federenden für Gefäße mit einem Durchmesser 0,5 - 2,0 mm  
 Maulinnenflächen schräg gerieft für schonendes, sicheres Festhalten der Gefäße  
 Der fest eingestellte Schließdruck gewährt risikofreie Anwendung

**for temporary occlusion**

(identified by yellow coloured spring ends) for vessel diam. 0,5 - 2,0 mm  
 Blade gripping surface with oblique serrations for save but careful gripping of vessels  
 No risk due to rigidly fixed pressure measure

**para uso temporal**

clips marcados con baño dorado en los resortes, para vasos con un diámetro de 0,5 - 2,0 mm  
 El interior de las quijadas viene con estrias finas para un agarre seguro y cuidadoso de los vasos  
 Debido a la calibración exacta de la fuerza de cierre se ofrece una aplicación sin riesgo

**per chiusura temporanea**

per vasi con Diametro 0,5 - 2,0 mm  
 La chiusura regolata garantisce nessun rischio

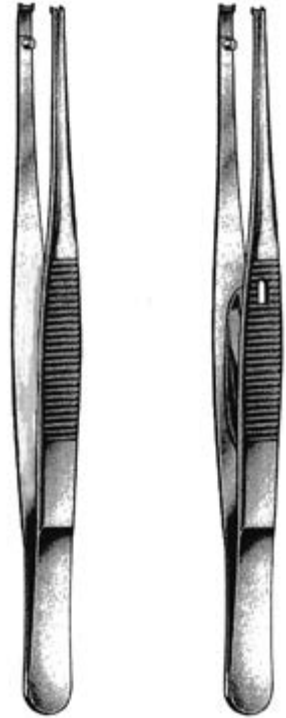

	Maulöffnung Opening	Maullänge Length of jaws	Schließkraft Closing Force		
	Apertura de la boca	Largo de la boca	Fuerza del cierre		
	Apertura del morso	Lunghezza del morso	Forza di chiusura		
	3,0 mm	4,5 mm	30 - 40 g (0,29 - 0,39 N)	BIEMER 41663-01	BIEMER 41663-02
	5,0 mm	9,0 mm	30 - 40 g (0,29 - 0,39 N)	Anlegepinzette ohne Schloß, für Mikro-Gefäßclips 41661-40 - 41662-50 und Approximatoren 41667-30 - 41670-50 und 41672-01 - 41672-04	Anlegepinzette mit Schloß, für Mikro-Gefäßclips 41661-40 - 41662-50 und Approximatoren 41667-30 - 41670-50 und 41672-01 - 41672-04
	5,0 mm	9,0 mm	30 - 40 g (0,20 - 0,25 N)	Applying forceps without lock. for vessel clips 41661-40 - 41662-50 and Aproximadors 41667-30 - 41670-50 and 41672-01 - 41672-04	Applying forceps with lock. for vessel clips 41661-40 - 41662-50 and Aproximadors 41667-30 - 41670-50 and 41672-01 - 41672-04
	5,0 mm	9,0 mm	30 - 40 g (0,20 - 0,25 N)		
	5,0 mm	9,0 mm	30 - 40 g (0,20 - 0,25 N)		

Approximatoren nach Müller  
Müller Approximators  
Aproximadores de Müller  
Aprossimatore secondo Müller

für temporären Gebrauch

gekennzeichnet durch gelb eingefärbte Federenden für Gefäße mit einem Durchmesser 0,5 - 2,0 mm  
Maulinnenflächen schräg gerieft für schonendes, sicheres Festhalten der Gefäße  
Der fest eingestellte Schließdruck gewährt risikofreie Anwendung

for temporary occlusion

(identified by yellow coloured spring ends) for vessel diam. 0,5 - 2,0 mm  
Blade gripping surface with oblique serrations for save but careful gripping of vessels  
No risk due to rigidly fixed pressure measure

para uso temporal

clips marcados con baño dorado en los resortes, para vasos con un diámetro de 0,5 - 2,0 mm  
El interior de las quijadas viene con estrías finas para un agarre seguro y cuidadoso de los vasos  
Debido a la calibración exacta de la fuerza de cierre se ofrece una aplicación sin riesgo

per chiusura temporanea

per vasi con Diametro 0,5 - 2,0 mm  
La chiusura regolata garantisce nessun rischio

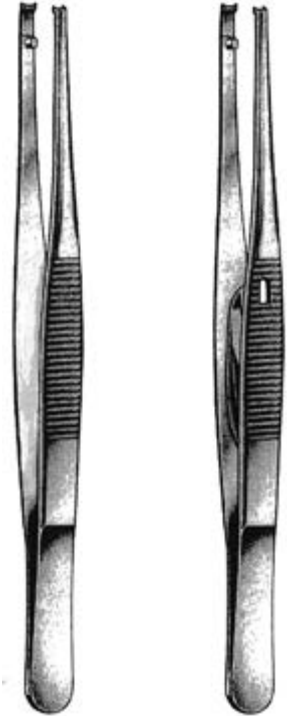

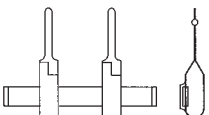
	Ø Diameter	Schließkraft Closing Force Fuerza del cierre Forza di chiusura
41672-01	1,0 mm	25 - 30 g (0,25 - 0,29 N)
41672-02	2,0 mm	25 - 30 g (0,25 - 0,29 N)
41672-03	3,0 mm	25 - 30 g (0,25 - 0,29 N)
41672-04	4,0 mm	25 - 30 g (0,25 - 0,29 N)

BIEMER  
41663-01

Anlegepinzette ohne  
Schloß,  
für Mikro-Gefäßclips  
41661-40 - 41662-50  
und  
Approximatoren  
41667-30 - 41670-50  
und  
41672-01 - 41672-04

Applying forceps without  
lock.  
for vessel clips  
41661-40 - 41662-50  
and  
Aproximadores  
41667-30 - 41670-50  
and  
41672-01 - 41672-04

BIEMER  
41663-02

Anlegepinzette mit  
Schloß,  
für Mikro-Gefäßclips  
41661-40 - 41662-50  
und  
Approximatoren  
41667-30 - 41670-50  
und  
41672-01 - 41672-04

Applying forceps with  
lock.  
for vessel clips  
41661-40 - 41662-50  
and  
Aproximadores  
41667-30 - 41670-50  
and  
41672-01 - 41672-04

Gefäßclips nach Müller  
 Müller Vessel Clips  
 Clips para vasos de Müller  
 Clip secondo Müller

für temporären Gebrauch

Maulinnenflächen pyramidenförmig für schonendes, sicheres Festhalten der Gefäße

Der fest eingestellte Schließdruck gewährt risikofreie Anwendung

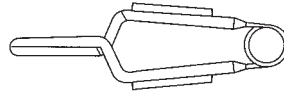

41674-50

Schließkraft  
 Closing Force  
 Fuerza del cierre  
 Forza di chiusura

50 g

for temporary occlusion

Blade gripping surface with pyramid-like impressions for save but careful gripping of vessels

No risk due to rigidly fixed pressure measure

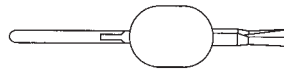

41674-80

80 g

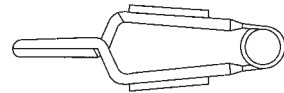

41675-50

50 g

para uso temporal

El interior de las quijadas viene en forma de pirámide para un agarre seguro y cuidadoso de los vasos.

Debido a la calibración exacta de la fuerza de cierre se ofrece una aplicación sin riesgo.

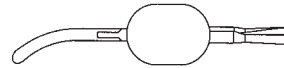

41675-80

80 g

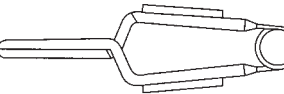

41676-50

50 g

per uso temporaneo

Morso interno con forma piramidale per garantire una chiusura sicura del vaso

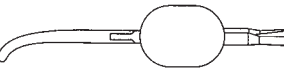

41676-80

80 g

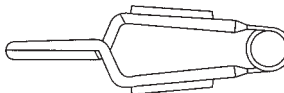

41677-50

50 g

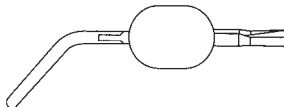

41677-80

80 g

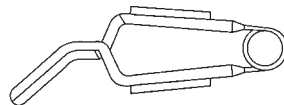

41678-50

50 g

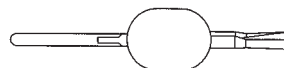

41678-80

80 g

Approximator nach Biemer  
 Biemer Approximator  
 Aproximadores de Biemer  
 Approssimatore secondo Biemer

für Mikro-Gefäßanastomosen im oberflächlichen Bereich

Maulinnenflächen schräg gerieft für schonendes, sicheres Festhalten der Gefäße

Der fest eingestellte Schließdruck gewährt risikofreie Anwendung

Der Abstand zwischen den Clips ist durch einfaches Verschieben einzustellen und wird durch Verkanten fixiert

for micro vessel anastomosis in the superficial range

Blade gripping surface with oblique serrations for save but careful gripping of vessels

No risk due to rigidly fixed pressure measure

Adjustable distance between the clips and automatic fixation by tilting

para micro-anastomosis en la superficie

El interior de la quijada viene con estrias finas para un agarre seguro y cuidadoso de los vasos.

Debido a la calibración exacta de la fuerza de cierre se ofrece una aplicación sin riesgo.

El espacio entre los clips se logra fácilmente por el desplazamiento.

per micro vasi anastomosi sulla parte della superficie

Parte interna del morso è leggermente striata obliqua per ottenere la presa sulla superficie del vaso.

La chiusura regolata garantisce nessun rischio.

Lo scorrimento delle due clips viene regolato con semplice movimento che consente una chiusura ottimale.

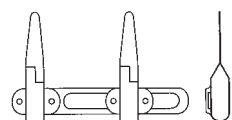

41679-25

Schließkraft  
 Closing Force  
 Fuerza de cierre  
 Forza di chiusura

25 - 30 g  
 (0,25 - 0,29 N)



BIEMER  
 41680-00

Anlegepinzette für Gefäß-  
 Approximator nach BIEMER

Applying forceps for BIEMER  
 vessel approximator

Pinza de aplicación para  
 aproximadores de BIEMER

Pinza posa clips per vasi  
 approssimatori secondo  
 BIEMER





LEYLA Retraktor System  
 LEYLA Retractor System  
 Separador de sistema LEYLA  
 LEYLA Sistema di fissaggio



## YASARGIL

- 41801-01 Hirnspatelhalter, flexibel, für 1 flachen Spatel, komplett, bestehend aus:  
 brain retractor, flexible, for 1 flat spatula, complete, consisting of:  
 separador autoretentivo, flexible, para espátula con 1 brazo flexible, completo, compuesto de:  
 divaricatore autostatico, flessibile, per spatole piatte, con 1 braccio flessibile, completo, composto da:
- 41810-10 flexibler Spannarm  
 flexible arm  
 brazo flexible  
 braccio flessibile
- 41826-26 Fixiervorrichtung für 1 flexiblen Spannarm  
 fixation base for 1 flexible arm  
 fijador para 1 brazo flexible  
 fissatore per 1 braccio al braccio rigido
- 41830-30 Spatelhalter für flache Spatel  
 support for flat brain spatula  
 soporte para espátulas cerebrales planas  
 sostegno per spatole piatte



## YASARGIL

- 41802-02 Hirnspatelhalter, flexibel für 2 flache Spatel, komplett, bestehend aus:  
 brain retractor, flexible, for 2 flat spatulas, complete, consisting of:  
 separador autoretentivo, flexible, para 2 espátulas planas con 2 brazos flexibles, completo, compuesto de:  
 divaricatore autostatico, flessibile, per spatole piatte, con 2 bracci flessibili, completo, composto da:
- 41810-10 flexibler Spannarm (2x)  
 flexible arm (2x)  
 brazo flexible (2x)  
 braccio flessibile (2x)
- 41822-22 Fixiervorrichtung für 2 flexible Spannarme  
 fixation base for 2 flexible arms  
 fijador para 2 brazos  
 fissatore per 2 bracci al cranio
- 41830-30 Spatelhalter für flache Spatel (2x)  
 support for flat brain spatula (2x)  
 soporte para espátulas cerebrales planas (2x)  
 sostegno per spatole piatte (2x)

LEYLA Retraktor System  
 LEYLA Retractor System  
 Separador de sistema LEYLA  
 LEYLA Sistema di fissaggio

41821-21

Fixiervorrichtung für 1 flexiblen Spannarm zum Festschrauben an Rohrteilen bis  $\varnothing$  16 mm

Fixation base for mounting on bars up to  $\varnothing$ 16 mm, for 1 flexible arm

Fijador para 1 brazo flexible, para atornillar a tubos hasta 16 mm

Fissatore per 1 braccio al braccio rigido



41822-22

Fixiervorrichtung für 2 flexible Spannarme zum Festschrauben am Schädel

Fixation base for skull mounting, holding 2 flexible arms

Fijador para 2 brazos flexibles, para atornillar al cráneo

Fissatore per 2 bracci al cranio



41826-26

Fixiervorrichtung für 1 flexiblen Spannarm zum Festschrauben am Schädel

Fixation base for skull mounting, holding 1 flexible arm

Fijador para 1 brazos flexibles, para atornillar al cráneo

Fissatore per 1 braccio al cranio



41830-30

Spatelhalter für flache Hirnspatula zur Befestigung am Spannarm

Support for flat brain spatula

Soporte para espátulas cerebrales planas para fijación al brazo flexible

Sostegno per spatole piatte



41832-32

Halter für Hirnspatula mit rundem Schaft bis  $\varnothing$  5,5 mm zur Befestigung am Spannarm

Support for brain spatula with round shaft

Soporte para espátulas cerebrales con mango redondo hasta  $\varnothing$  5,5 mm para fijación al brazo flexible

Sostegno flessibile per spatola cerebrale



LEYLA Retraktor System  
 LEYLA Retractor System  
 Separador de sistema LEYLA  
 LEYLA Sistema di fissaggio



## YASARGIL

41810-10

flexibler Spannarm, allein  
 flexible arm, only  
 brazo flexible, suelto  
 braccio flessibile, solo

## YASARGIL

41803-01

Ohrspekulahalter, komplett, bestehend aus:  
 ear specula holder, complete, consisting of:  
 soporte para espejos auriculares completo,  
 compuesto de:  
 sostegno per specolo auricolare, completo  
 composto da:

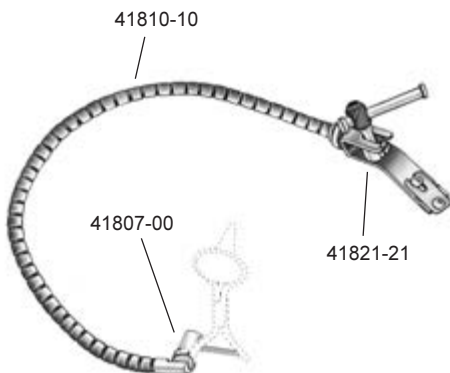

41810-10

flexibler Spannarm  
 flexible arm, only  
 brazo flexible, suelto  
 braccio flessibile, solo

41821-21

Fixiervorrichtung zum Befestigen an Rohrteilen  
 bis Ø 16 mm  
 clamp for fixation on bars up to Ø 16 mm  
 fijador para 1 brazo flexible, para atornillar a  
 tubos hasta 16 mm  
 fissatore al braccio rigido Ø 16 mm

41807-00

Ohrtrichterhalter, allein  
 ear specula holder, only  
 soporte para espejos auriculares, suelto  
 sostegno per specolo auricolare

LEYLA Retraktor System  
 LEYLA Retractor System  
 Separador de sistema LEYLA  
 LEYLA Sistema di fissaggio

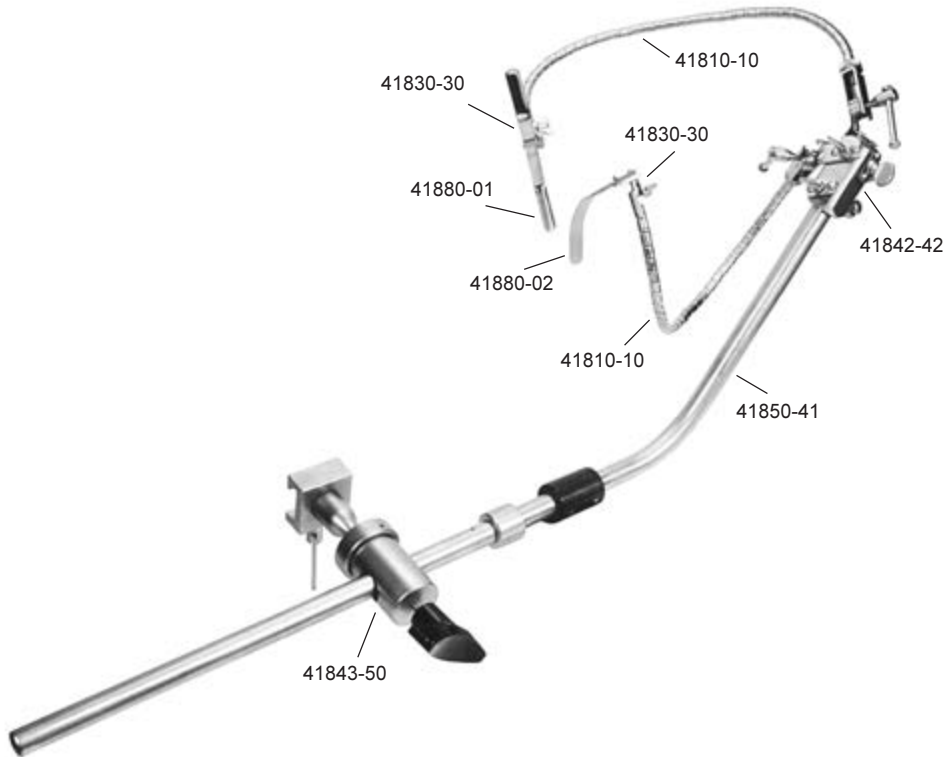

41802-00 LEYLA-Retraktor-System zum Fixieren am OP-Tisch komplett, bestehend aus:  
 LEYLA Self-Retraining Retractor for fixation to operating table, complete, consisting of:  
 Separador LEYLA para fijacion a la mesa de operaciones, completo, compuesto de:  
 LEYLA Sistema di fissaggio al tavolo operatorio, composto da:

41843-50	Kugelgelenkkloben (1x) ball and socket joint (1x) articulacion esferica (1x) giunto per fissare (1x)	41830-30	Spatelhalter für flache Spatel (2x) support for flat brain spatula (2x) soporte para espátulas cerebrales planas (2x) sostegno per spatole piatte (2x)
41850-41	starrer Haltearm (1x) rigid holding rod (1x) brazo de fijación rígido (1x) braccio di fissaggio rigido (1x)	41880-01	CUSHING Hirnspatel (1x) CUSHING brain spatula (1x) CUSHING espatula para cerebro (1x) CUSHING spatola cerebrale (1x)
41842-42	Kupplungskopf (1x) coupling head (1x) cabeza de acoplamiento (1x) giunto per combinare (1x)	41880-02	CUSHING Hirnspatel (1x) CUSHING brain spatula (1x) CUSHING espatula para cerebro (1x) CUSHING spatola cerebrale (1x)
41810-10	flexibler Spannarm (2x) flexible arm, only (2x) brazo flexible, suelto (2x) braccio flessibile, solo (2x)		

LEYLA Retraktor System  
 LEYLA Retractor System  
 Separador de sistema LEYLA  
 LEYLA Sistema di fissaggio



- 41843-50 Kugelgelenkkloben zum Befestigen an der OP-Tischschiene und zur Aufnahme des Haltearms 41850-41
- 
- ball and socket joint for fixation of holding rod 41850-41 at the operating table
- 
- articulacion esferica, para sujetar el brazo de soporte rigido sobre la mesa de operaciones 9 x 32 mm
- 
- giunto per fissare il braccio, articolato 9 x 32 mm



- 41850-41 starrer Haltearm, auseinandernehmbar, zur Fixation im Kugelgelenkkloben 41843-50 und zur wahlweisen Aufnahme der Kupplungsköpfe 41842-42, 41842-44 und 41842-46
- 
- holding rod, detachable, for fixation in ball and socket joint 41843-50 and to hold a desired coupling head 41842-42, 41842-44 or 41842-46
- 
- brazo de soporte rigido, desmontable, para fijacion a la articulacion esferica 41843-50 y opcionalmente a las cabezas 41842-42, 41842-44 y 41842-46
- 
- braccio di sostegno rigido, per fissaggio al giunto 41843-50 e dei giunti 41842-42, 41842-44 e 41842-46



- 41842-42 Kupplungskopf, zur Aufnahme von max. 5 flexiblen Spannarmen 41810-10
- 
- coupling head to hold 5 flexible arms 41810-10
- 
- cabeza de acoplamiento para fijar hasta 5 brazos flexibles
- 
- giunto per combinare 5 bracci



- 41842-44 Kupplungskopf, drehbar, zur Aufnahme von 1 flexiblen Spannarm 41810-10
- 
- coupling head, turnable, to hold 1 flexible arm 41810-10
- 
- acoplamiento, girable y se puede fijar en todas las posturas para sujetar un brazo flexible 41810-10
- 
- giunto per combinare, rotabile, per sostegno del braccio 41810-10
- 
- 41842-46 Kupplungskopf, seitlich offen zur Aufnahme von 1 flexiblen Spannarm 41810-10
- 
- coupling head, lateral open, to hold 1 flexible arm 41810-10
- 
- acoplamiento, abierto al lado, para un brazo flexible 41810-10
- 
- giunto per fissare il braccio, per 41810-10

Hirnspatel  
Brain Spatulas  
Espátula Cerebral  
Spatole Cerebrali



HEIFETZ  
200 mm  
8"

Breite	Gesamtlänge
width	total length
ancho	largo total
larghezza	lunghezza totale

41860-14	14 mm	200 mm
41860-17	17 mm	200 mm
41860-20	20 mm	200 mm



biegsam  
malleable  
maleable  
malleabili



HEIFETZ  
155 mm  
6"

Breite	Gesamtlänge
width	total length
ancho	largo total
larghezza	lunghezza totale

41870-08	8 mm	155 mm
41870-11	11 mm	155 mm
41870-14	14 mm	155 mm
41870-17	17 mm	155 mm

Breite	Gesamtlänge
width	total length
ancho	largo total
larghezza	lunghezza totale

41880-01	9 mm	200 mm
41880-02	12 mm	200 mm
41880-03	12 mm	250 mm



biegsam  
malleable  
maleable  
malleabili

CUSHING  
200 mm, 8"

Lidsperrer  
Eye Specula  
Blefaróstatos  
Blefarostati

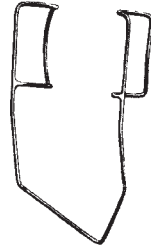

BARRAQUER (Colibri)

43101-03 3 cm, 1.2" für Kinder / children / niños / bambini  
43101-04 4 cm, 1.6" für Erwachsene / adults / adultos / adulti



BOWMAN

43104-07  
7 cm, 2 3/4"

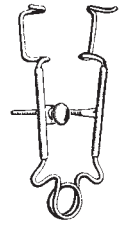

CRITCHETT

43105-06  
7 cm, 2 3/4"



SMITH  
43106-05  
5 cm, 2"

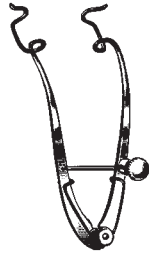

CLARK  
43107-08  
8 cm, 3 1/8"



GRAEFE

43109-07 7 cm, 2 3/4"  
43109-09 9 cm, 3 1/2"



WEEK  
43110-08  
8 cm, 3 1/8"

rechts  
right  
a la derecha  
destro

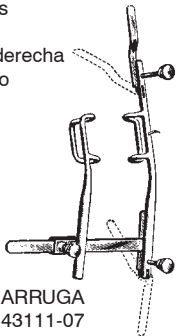

ARRUGA  
43111-07  
7 cm, 2 3/4"

links  
left  
a la izquierda  
sinistro

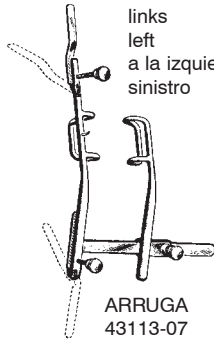

ARRUGA  
43113-07  
7 cm, 2 3/4"

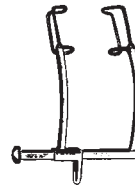

MURDOCK  
43115-05  
5 cm, 2"

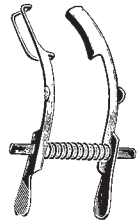

MELLINGER-AXENFELD  
43121-07  
7 cm, 2 3/4"

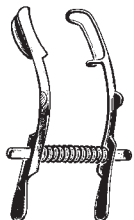

MELLINGER-AXENFELD  
43123-07  
7 cm, 2 3/4"

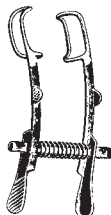

MELLINGER  
43125-05 5 cm, 2"  
43125-07 7 cm, 2 3/4"



LISTER-BURCH  
43127-08  
8 cm, 3 1/8"



WILLIAMS  
43128-08  
8 cm, 3 1/8"



Lidsperrer, Lidplatte, Starmesser  
 Eye Specula, Lid Plate, Cataract Knives  
 Blefaróstatos, Placa para párpados, cuchillos para cataratas  
 Blefarostati, Placca per palpebre, coltelli per cataratta

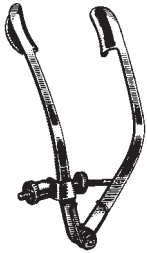

LANCASTER  
 43129-07  
 7 cm, 2 3/4"



ZIEGLER  
 43130-07  
 7 cm, 2 3/4"



CASTROVIEJO  
 43132-08  
 8 cm, 3 1/8"

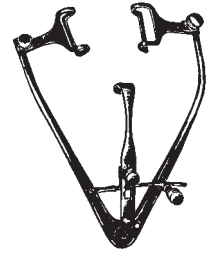

PARK  
 43133-08  
 8 cm, 3 1/8"



MUELLER  
 43135-07  
 7 cm, 2 3/4"



STEVENSON  
 43139-07  
 7 cm, 2 3/4"



LIEBERMAN  
 43140-08  
 8 cm 3 1/8"



LIEBERMAN  
 43141-08  
 8 cm 3 1/8"



JAEGER  
 43150-11  
 11 cm, 4 3/8"



GRAEFE  
 43170-00 - 43170-03  
 13 cm, 5 1/8"



43170-00



43170-01



43170-02



43170-03



DEUTSCHMANN  
 43172-13  
 13 cm, 5 1/8"

Lanzenmesser, Diszisionsmesser, Irismesser, Diszisionsmesser  
 Cataract knife, keratome, Iris knife, discision knife  
 Cuchillos lanceolares y Cuchillos de discisión  
 Cheratom, bisturi p. capsule, bisturi corneale

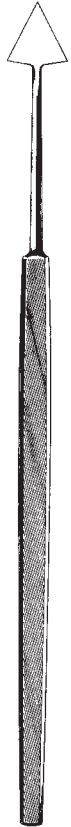

JAEGER  
 43180-01 Fig. 1 13 cm, 5 1/8"  
 43180-02 Fig. 2 13 cm, 5 1/8"  
 43180-03 Fig. 3 13 cm, 5 1/8"



JAEGER 45°  
 43181-01 Fig. 1  
 43181-02 Fig. 2  
 43181-03 Fig. 3



BERENS  
 43183-13  
 13 cm, 5 1/8"



CASTROVIEJO  
 43185-13 13 cm  
 4 x 13 mm



GRAEFE  
 43187-13  
 13 cm, 5 1/8"

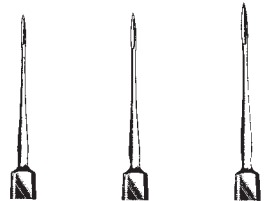

KNAPP  
 43202-01 Fig. 1 13 cm, 5 1/8"  
 43202-02 Fig. 2 13 cm, 5 1/8"  
 43202-03 Fig. 3 13 cm, 5 1/8"

43180-01 - 43181-03



ZIEGLER  
 43210-01 5 mm  
 Fig. 1  
 13 cm, 5 1/8"



ZIEGLER  
 43210-02 6 mm  
 Fig. 2  
 13 cm, 5 1/8"



ZIEGLER  
 43210-03 7 mm  
 Fig. 3  
 13 cm, 5 1/8"



DEAN  
 43213-12  
 12,5 cm, 5"

Hornhautmesser, Hornhautschaber, Dissektor, Sklerotom, Goniotomiemesser  
 Corneal Scarifier, -dissector, sclerotome, goniotomy knife  
 Cuchillos para cornea, legtras corneales, esclerótomos  
 Spatole p. corneale, dissetore corneale, sclerotomo, coltello per goniotomia



WHEELER  
 43218-12  
 12 cm, 4 3/4"



ZIEGLER  
 43221-11  
 11 cm, 4 3/8"  
 3,5 mm



TOOK  
 43228-12  
 12 cm, 4 3/4"



GILL  
 43231-12  
 12 cm, 4 3/4"



ELSCHNIG  
 43233-13  
 13 cm, 5 1/8"



PATON  
 43245-12  
 12 cm, 4 3/4"



LUNDSGAARD  
 43251-12  
 12 cm, 4 3/4"



GUYTON-  
 LUNDSGAARD  
 43253-12



BARKAN  
 43256-12



SCHEIE  
 43258-12



BURCH  
 43262-12



PAUFIQUE  
 43271-11



BARRAQUER  
 43273-13

Diszisionsnadeln, Fremdkörpernadeln, Fremdkörperhohlmeißel  
 Discision Needles, Foreign-Body Instruments  
 Aguja de discisión, Instrumental para cuerpos extraños  
 Aghi per discisione, strumenti per corpi estranei



43304-12



43305-12

BOWMAN  
43308-12BOWMAN  
43309-12

43310-13



43311-13

LEVINSON  
43314-13FRANCIS  
43321-12DAVIS  
43325-13LA FORCE  
43327-12DIX  
43330-13ELLIS  
43331-11WALTON  
43332-12  
1,4 mmWALTON  
43334-12  
1,4 mmALVIS  
43336-12GREEN  
43340-13ROLLET  
43342-12

Schielhaken, Tenotomiehaken, Extraktionshaken, Tränenackhäkchen  
 Strabismus hook, lens hook, extraction hook  
 Ganchos para estrabismo, - cristalino, extracción  
 Uncino per il strabismo, uncino p. cristallino, protettori, uncini per l'iride



Fig. 1  
 GRAEFE  
 43351-01  
 13 cm, 5 1/8"



Fig. 2  
 GRAEFE  
 43351-02  
 14 cm, 5 1/2"



Fig. 3  
 GRAEFE  
 43351-03  
 15 cm, 6"



JAMESON  
 43353-13



GREEN  
 43355-13



STEVENS  
 43357-13



Fig. 1  
 ARRUGA  
 43363-01



Fig. 2  
 ARRUGA  
 43363-02



O'CONNOR  
 43370-12



WIENER  
 43372-13



WIENER  
 43373-13



ROLLET  
 43376-13



KNAPP  
 43377-13



GRAEFE  
 43380-13



GRAEFE  
 43381-13



GRAEFE  
 43383-13



BECKER  
 43386-13

Implantations Instrumente  
 Instruments for Implantation  
 Instrumentos para implantaciòn  
 Strumenti per impianto

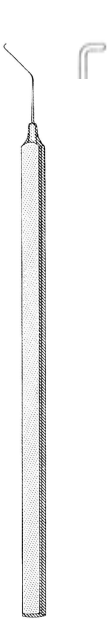

CLAYMAN  
 43387-02  
 11,5 cm 4 1/2"



SINSKEY  
 43388-02  
 11,4 cm 4 1/2"



SINSKEY  
 43389-02  
 12 cm 4 3/4"

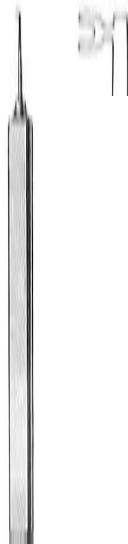

KUGLEN  
 43390-05  
 11,7 cm 4 5/8"

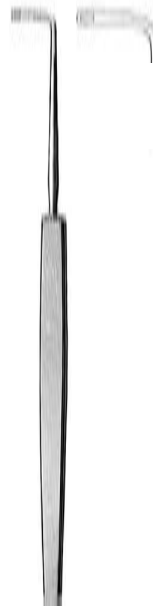

GASS  
 43391-13  
 14,6 cm 5 3/4"

Küretten und Löffel für Chalazion und Star  
 Scoops and Curettes for Chalazio, Cataract, and Exenteration  
 Curetas y cucharillas para chalazión, catarata y exenteración  
 Curette e cucchiari per calazio, cateratta e palpebre

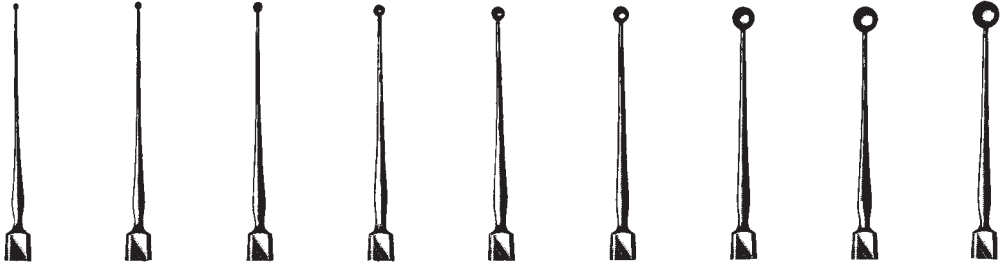

MEYHOEFER

	43402-05	43402-10	43402-15	43402-18	43402-20	43402-25	43402-35	43402-40	43402-45
Ø mm	0,5	1,0	1,5	1,8	2,0	2,5	3,5	4,0	4,5

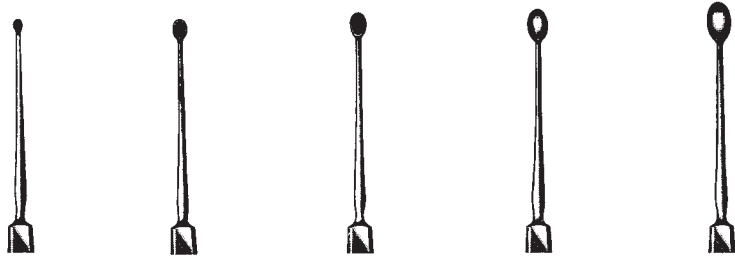

	HEBRA	HEBRA	HEBRA	HEBRA	HEBRA
	43404-10	43404-20	43404-24	43404-30	43404-35
Ø mm	1,0	2,0	2,5	3,0	3,5



AXENFELD  
43407-13



GRAEFE  
43410-01



GRAEFE  
43410-02



DAVIEL  
43412-01  
3 mm



DAVIEL  
43412-02  
4 mm

Starlöffel, Exenterationslöffel, Drahtschlingen, Starschlingen, Irisspatel, Enukleationslöffel, Wundlöffel  
 Cataract Spoon, Exenteration Scoops, Lens Scoops, Spatulas, Protectores  
 Cucharillas para Catarata-, exenteración, Asas, Espátulas, Protectores  
 Cucchiaino per cataratta- esenterazione, Anse, Spatole, Protettori



KNAPP  
43414-02



BUNGE  
43420-01



BUNGE  
43420-02



BUNGE  
43420-03



LANG  
43424-13



WEBER  
43441-01  
Fig. 1



43441-02  
Fig. 2



SNELLEN  
43443-13



WILDER  
43445-13  
Fig. 1



43447-13  
Fig. 2



ARLT



43449-01

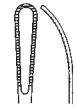

43449-02

Cautery  
Cauter  
Cauterio

Iris  
Iride



WECKER  
43461-13



WECKER  
43462-13



WELLS  
43482-20



ARRUGA  
43485-13



WADSWORTH-TODD  
43487-14



Zyklodialysespatel, Fremdkörperinstrumente  
 Cyclodialysis Spatula, Foreign Body Instruments  
 Espátulas para ciclodíalisis, Instrumentos para cuerpos extraños  
 Spatole per ciclodialisi, Strumenti per corpi estranei



BANGERTER



43501-06  
6 mm

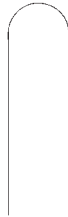

43501-10  
10 mm



43501-12  
12 mm



43511-13 - 43517-09



CASTROVIEJO  
43511-13  
1,2 x 10 mm



CASTROVIEJO  
43513-14  
1,5 x 15 mm



ELSCHNIG  
43515-14  
1,2 x 12 mm



CASTROVIEJO  
43517-09  
0,8 x 15 mm

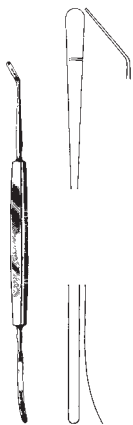

CASTROVIEJO  
43521-12  
12 cm, 4 3/4"



WHEELER  
43523-12  
12 cm, 4 3/4"



HIRSCHMAN  
43524-10  
12,5 cm, 5"



CASTROVIEJO  
43525-05 0,50 mm  
43525-07 0,75 mm  
43525-10 1,00 mm



BECHERT  
43526-12  
12,5 cm, 5"

Fremdkörperinstrumente, Meßzirkel, Kapselstanze

Foreign- Body Instruments, Markers, Corneoscleral punch

Instrumental para cuerpos extraños, Compás de la cápsula, Pinza para capsuloiridectom

Strumenti per corpi estranei, Marcatori, Pinza per capsula



DIX  
43542-12



DIX  
43544-12



DIX  
43546-13



DIX  
43548-13



CASTROVIEJO  
43583-07 0-20 mm  
7 cm, 2 3/4"



CONNIN-AMSLER  
43589-13



HOLTH  
43593-09  
9 cm, 3 1/2"

Tränenkanaldilatatoren, Sonden  
 Lachrymal Dilators-, Probes  
 Diladores, Estiletos para canal lacrimal  
 Dilatori e Specilli per canale lacrimale



WILDER  
43602-01



WILDER  
43602-02



WILDER  
43602-03



Fig. ZIEGLER  
 1/2 43605-12  
 3/4 43605-34  
 5/6 43605-56



CASTROVIEJO  
43608-12

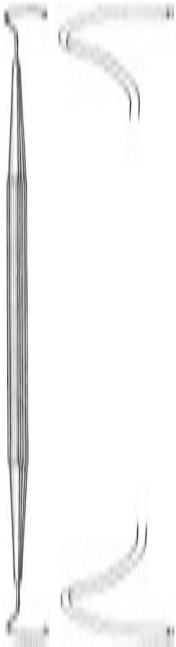

WORST  
43609-14  
14,9 cm 5 7/8"

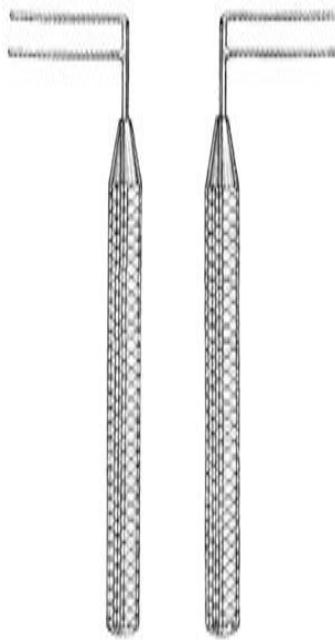

HARMS  
43610-01 43610-02  
4,8 cm 1 7/8"

geknöpft



rostfrei  
 stainless steel  
 acero inoxidable  
 acciaio inossidabile

Fig.	BOWMAN	Ø mm
0000/000	43613-00	0,6/0,7
00/0	43614-00	0,7/0,8
0/1	43614-01	0,8/0,9
1/2	43614-12	0,9/1,1
2/3	43614-23	1,1/1,3
3/4	43614-34	1,3/1,4
4/5	43614-45	1,4/1,5
5/6	43614-56	1,5/1,6
6/7	43614-67	1,6/1,8
7/8	43614-78	1,8/1,9

Iris Pinzetten  
 Iris Forceps  
 Pinzas para iris  
 Pinze per iride



GRAEFE  
 43802-07  
 7 cm (2 3/4")/1 mm

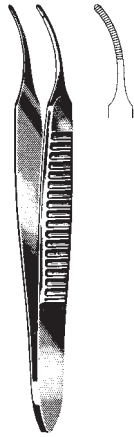

GRAEFE  
 43803-07  
 7 cm (2 3/4")/1 mm

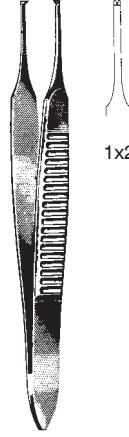

GRAEFE  
 43804-07  
 7 cm (2 3/4")/1 mm

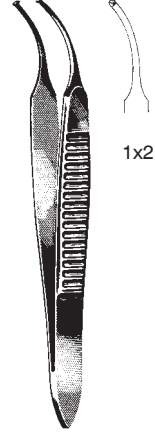

GRAEFE  
 43805-07  
 7 cm (2 3/4")/1 mm



GRAEFE  
 43810-10  
 10 cm  
 4"



GRAEFE  
 43811-10  
 10 cm  
 4"

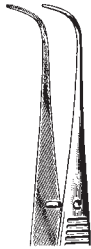

GRAEFE  
 43813-10  
 10 cm  
 4"



GRAEFE  
 43820-10  
 10 cm  
 4"

1x2



GRAEFE  
 43821-10  
 10 cm  
 4"

1x2



GRAEFE  
 43823-10  
 10 cm  
 4"

1x2

Iris Pinzetten  
Iris Forceps  
Pinzas para iris  
Pinze per iride



STEVENS  
43830-10  
10,5 cm, 4.1"



STEVENS  
43833-10  
10,5 cm  
4.1"



STEVENS  
43833-10  
10,5 cm  
4.1"



STEVENS  
43840-10  
10,5 cm  
4.1"



STEVENS  
43841-10  
10,5 cm  
4.1"



STEVENS  
43843-10  
10,5 cm  
4.1"

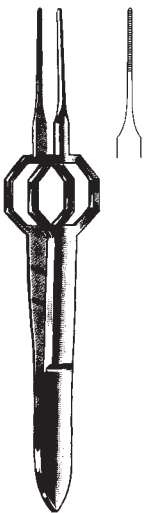

FOERSTER  
43850-08  
8,5 cm, 3.4"

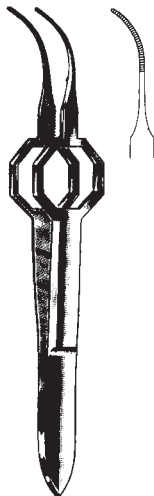

FOERSTER  
43851-08  
8,5 cm, 3.4"

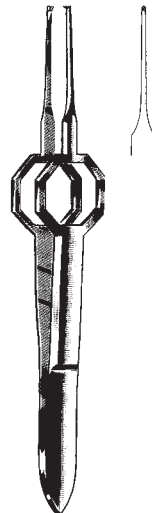

FOERSTER  
43852-08  
8,5 cm, 3.4"

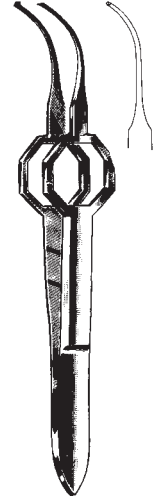

FOERSTER  
43853-08  
8,5 cm, 3.4"

Iris Pinzetten  
Iris Forceps  
Pinzas para iris  
Pinze per iride

seitliche Zähne  
lateral teeth  
dientes laterales  
denti laterali

Zähne abwärts  
teeth below  
dientes abajo  
denti in basso

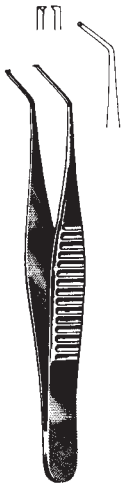

HESS  
43855-07  
7 cm (2 3/4")/  
0,3 mm

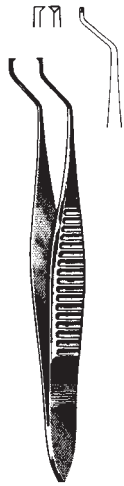

HESS  
43857-07  
7 cm (2 3/4")/  
0,3 mm



GILL  
43861-07  
7,5 cm (3")/  
0,3 mm



GILL-HESS  
43863-07  
7,5 cm (3")/  
0,3 mm

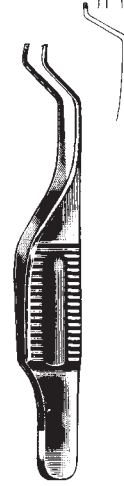

GILL-HESS  
43865-07  
7,5 cm (3")/  
0,3 mm

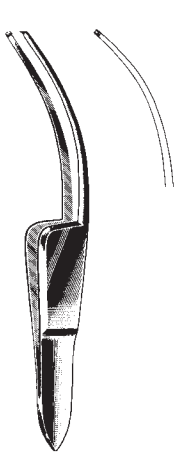

FISCHER  
43869-07  
7 cm (2 3/4")



BARRAQUER-KATZIN  
43881-07  
7 cm (2 3/4")/0,4 mm



TROUTMAN (Colibri)  
43883-07  
7 cm (2 3/4")/0,12 mm

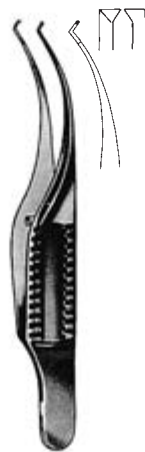

BARRAQUER (Colibri)  
43885-07  
7 cm (2 3/4")/0,12 mm



BARRAQUER (Colibri)  
43887-07  
7 cm (2 3/4")/0,12 mm

Fixierpinzette, Strabismus-Pinzetten  
 Fixation forceps, Strabismus-Forceps  
 Pinza para fijación, Pinzas para estrabismo  
 Pinza per fissatrice, Pinze per strabismo



1x2

KIRBY-ARTHUR  
 43891-09 9 cm, 3 1/2"  
 0,2 mm



McCULLOUGH  
 43902-09  
 9,5 cm, 3 3/4"



McCULLOUGH  
 43903-09  
 9,5 cm, 3 3/4"

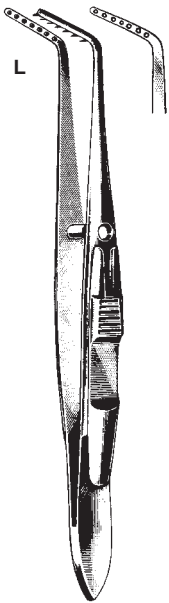

L

JAMESON  
 43907-10  
 10 cm, 4"

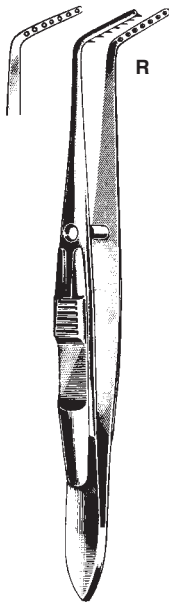

R

JAMESON  
 43909-10  
 10 cm, 4"



BONACCOLTO  
 43914-10  
 10 cm, 4"/1,7 mm



BONACCOLTO  
 43916-10  
 10 cm, 4"/1,2 mm



BONACCOLTO  
 43920-11  
 11 cm, 4 3/8"

Strabismus-Pinzetten, Iris-Pinzetten  
 Strabismus-Forceps, Iris Forceps  
 Pinzas para estrabismo, Pinzas para iris  
 Pinze per strabismo, Pinze per iride



DASTOOR  
 43924-11  
 11 cm, 4  $\frac{3}{8}$ "



DASTOOR  
 43926-11  
 11 cm, 4  $\frac{3}{8}$ "



BISHOP-HARMAN  
 43940-05 8,5 cm, 3.4"  
 0,5 mm



BISHOP-HARMAN  
 43940-08 8,5 cm, 3.4"  
 0,8 mm



BISHOP-HARMAN  
 43942-05 8,5 cm, 3.4"  
 0,5 mm



BISHOP-HARMAN  
 43942-08 8,5 cm, 3.4"  
 0,8 mm

1x2

1x2



Iris Pinzetten, Nahtpinzetten, Muskelpinzetten  
 Iris, Suture forceps, Muscle Forceps  
 Pinzas para iris, Pinza para sutura, Pinzas musculares  
 Pinze per iride, Pinza per sutura, muscolari

mit Führungsstift  
 with guide pin  
 con perno guida  
 con perno di guida

ohne Führungsstift  
 without guide pin  
 sin perno guida  
 senza perno di guida



MOD. BONN  
 43944-07  
 7 cm, 2 3/4"  
 0,12 mm



MOD. BONN  
 43946-07  
 7 cm, 2 3/4"  
 0,12 mm



MOD. BONN  
 43948-10  
 10 cm, 4"  
 0,12 mm



MOD. TÜBINGEN  
 43950-10  
 10 cm, 4"



MOD. BONN  
 43952-10  
 10 cm, 4"/0,12 mm



MOD. TÜBINGEN  
 43953-10  
 10 cm, 4"

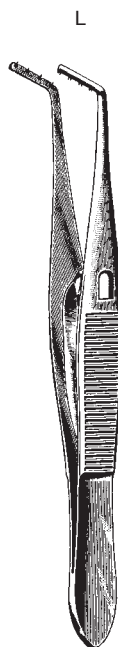

L

PRINCE  
 43955-10  
 10 cm, 4"

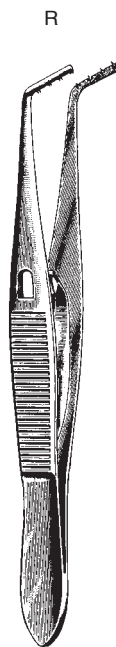

R

PRINCE  
 43956-10  
 10 cm, 4"



Muskelpinzetten, Fixationspinzetten  
 Muscule Forceps, Fixation Forceps  
 Pinzas musculares, Pinzas para fijación  
 Pinze muscolari, Pinze per fissaggio

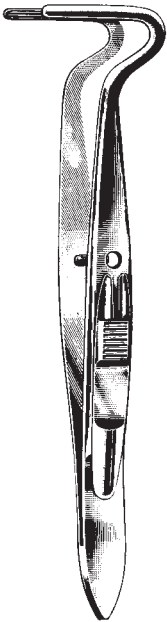

**BERKE**  
 44015-20 - 44015-27  
 10 cm, 4"

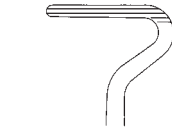

44015-20

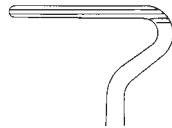

44015-27



1x2

**TROUTMAN**  
 44017-08 8,5 cm, 3.4"  
 0,8 mm



**ELSCHNIG**  
 44046-11  
 11 cm, 4 3/8"



**GRAEFE**  
 44050-11 - 44052-11  
 11 cm, 4 3/8"



44050-11



44052-11  
 mit Sperre  
 with catch  
 con cierre  
 c. cremagliera



**LESTER**  
 44054-09  
 9 cm, 3 1/2"

Fixierpinzetten, Kapselpinzette  
 Fixation forceps, capsular forceps  
 Pinzas para fijación, Pinzas capsulares  
 Pinze fissatrici, Pinze per capsulari

1x1



CASTROVIEJO  
 44066-09  
 9 cm, 3 1/2"

1x1



CASTROVIEJO  
 44067-09  
 9 cm, 3 1/2"

2x2



CASTROVIEJO  
 44068-09  
 9 cm, 3 1/2"

2x2



CASTROVIEJO  
 44069-09  
 9 cm, 3 1/2"



BARRAQUER  
 44074-10  
 10 cm, 4"

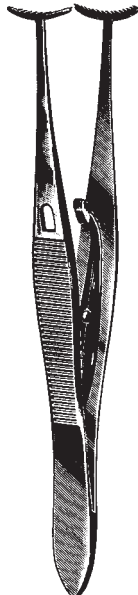

GREEN  
 44076-05 - 44078-10  
 10 cm, 4"



44076-05 44076-10  
 5 mm 10 mm  
 ohne Sperre  
 without catch  
 sin cierre  
 senza cremagliera



44078-05 44078-10  
 5 mm 10 mm  
 mit Sperre  
 with catch  
 con cierre  
 con cremagliera



GILL-ARRUGA  
 44101-07  
 7,5 cm, 3"

Kapselpinzetten  
 Capsular Forceps  
 Pinzas capsulares  
 Pinze capsulare



TERSON  
 44103-09  
 9 cm, 3 1/2"



KALT  
 44106-10  
 10 cm, 4"



ELSCHNIG  
 44109-10  
 10 cm, 4"



ARRUGA  
 44111-10  
 10 cm, 4"



ARRUGA  
 44114-10  
 10 cm, 4"



CASTROVIEJO  
 44115-10  
 10 cm, 4"



SCHWEIGGER  
 44117-10  
 10 cm, 4"



SCHWEIGGER  
 44119-10  
 10 cm, 4"



ELSCHNIG  
 44121-10  
 10 cm, 4"

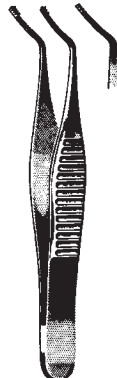

HESS  
 44125-06  
 6 cm, 2.4"



HESS  
 44127-06  
 6,5 cm, 2.6"

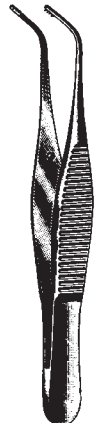

FUCHS  
 44129-07  
 7 cm, 2 3/4"

Nahtpinzetten, Fadenpinzetten  
 Suture Forceps, Tying Forceps  
 Pinzas para suturas y hilo  
 Pinze per sutura, Pinze per filo

1x2



CASTROVIEJO

10 cm, 4"

- 44150-01 0,12 mm
- 44150-03 0,30 mm
- 44150-05 0,50 mm
- 44150-10 1,00 mm
- 44150-15 1,50 mm

1x2



CASTROVIEJO

10 cm, 4"

- 44151-05
- 44151-10
- 44151-15

Zahn  
tooth  
diente  
dente



MOORFIELD

44164-10  
10 cm, 4"

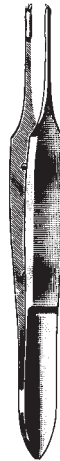

St. MARTIN

44166-07  
7 cm, 2 3/4"



Mod. TÜBINGEN

44181-10  
10 cm, 4"

1x2



PAUFIQUE

44190-08  
8,5 cm, 3.4"



PAUFIQUE

44202-08  
8,5 cm, 3.4"



McPHERSON

44210-10  
10 cm, 4"



McPHERSON

44220-10  
10 cm, 4"

Pinzetten für Chalazion und Trachom  
 Forceps for Chalazion and Trachoma  
 Pinzas de chalazión y para tracoma  
 Pinze per calazio e per trichiasi



AYER  
 44240-09  
 9 cm, 3 1/2"



AYER  
 44242-09  
 9 cm, 3 1/2"



LAMBERT  
 44246-09  
 9 cm, 3 1/2"



DESMARRES  
 44254-09 - 44258-09  
 9 cm, 3 1/2"

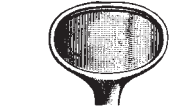

44254-09 20 mm  
 Fig. 1

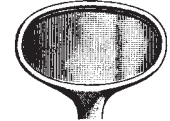

44256-09 24 mm  
 Fig. 2

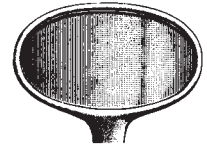

44258-09 32 mm  
 Fig. 3

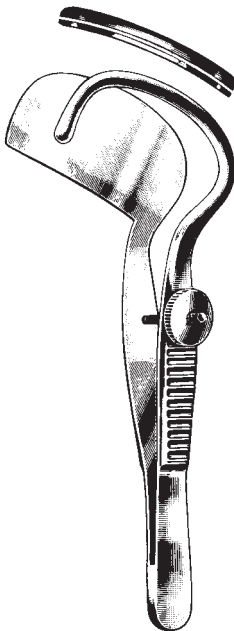

SNELLEN  
 44265-10 10 cm, 4"

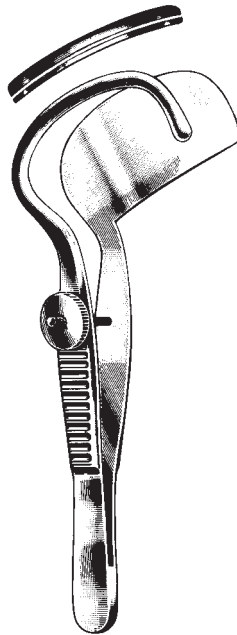

SNELLEN  
 44267-10 10 cm, 4"

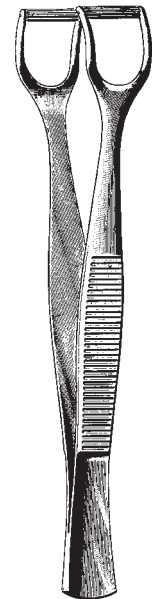

KNAPP-LUER  
 44274-11 11 cm, 4 3/8"

Augenkanülen  
 Eye Cannulas  
 Cánulas oculares  
 Cannule oculistiche



LACRIMAL  
 44300-00 23 gauge



LACRIMAL  
 44301-00 23 gauge



McIntyre  
 44310-00 23 gauge



McIntyre  
 44311-00 23 gauge



Air Injection  
 44320-00 27 gauge  
 44330-00 30 gauge



JENSEN  
 44340-00 23 gauge  
 44350-00 25 gauge



Spül- und Saugkanülen, Augenkanülen  
Irrigation and Aspiration Cannulas, Eye Cannulas  
Cánulas de irrigación y aspiración, Cánulas oculares  
Cannule per irrigazione ed aspirazione, Cannule oculistiche

**BISHOP-HARMON**

44370-00 komplett / complete

44371-00 Silikonball / silicone bulb

44372-00 Adapter / adaptor

44373-00 19 gauge Kanüle / cannula

44374-00 21 gauge Kanüle / cannula

Augenkanülen, Tonometer  
 Eye Cannulas, Tonometer  
 Cánulas oculares, Tonómetro  
 Cannule oculistiche, Tonometro



SHEETS  
44380-00

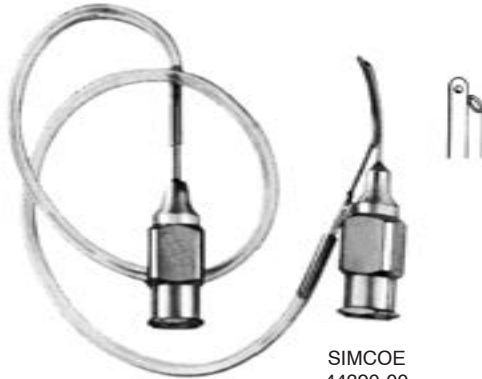

SIMCOE  
44390-00

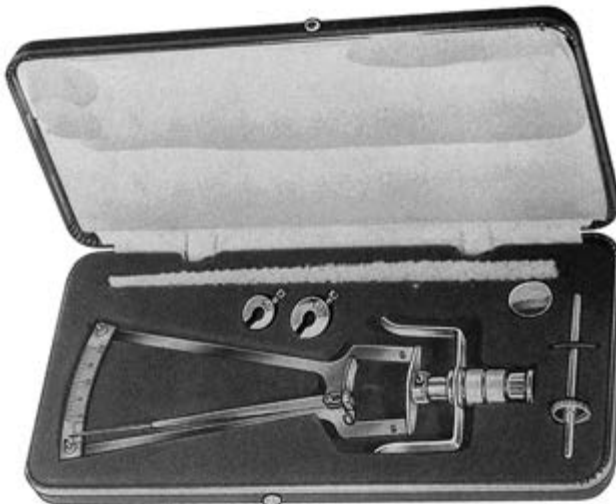

	SCHIOETZ	
	44404-00	44406-00
Skala	gerade	schräg
scale	straight	oblique
escala	recta	oblícua
scala	retta	obliqua

44404-00 G	geeicht
44406-00 G	calibrated
	calibrado
	calibrato

Augenmagnet, Cilienpinzetten  
 Eye Magnet, Cilia Forceps  
 Imàn para cuerpos extraños, Pinzas depilatorias  
 Calamita per corpi estranei, Pinze depilatorie



REDA  
44408-00



BEER  
44420-09  
9 cm, 3 1/2"

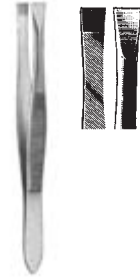

DOUGLAS  
44422-09  
9 cm, 3 1/2"



LITTAUER  
44424-08  
8,5 cm, 3.4"



BARRAQUER  
44425-10  
10,5 cm, 4.1"



REDA  
44426-09  
9 cm, 3 1/2"

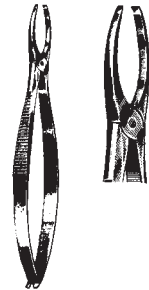

GRADLE  
44428-09  
9,5 cm, 3 3/4"







Ohrspekula  
Ear Specula  
Espéculos auriculares  
Specoli auricolari



POLITZER  
45009-00  
Set = 3

Innen Ø  
○ = 2,0 mm  
45009-02

○ = 3,0 mm  
45009-03

○ = 4,0 mm  
45009-04



HARTMANN  
45010-00  
Set = 4

Innen Ø  
○ = 2,0 mm  
45010-20

○ = 3,0 mm  
45010-30

○ = 4,5 mm  
45010-45

○ = 5,5 mm  
45010-55

○ = 6,5 mm  
45010-65

○ = 7,5 mm  
45010-75



HARTMANN  
45011-00  
Set 3-7 mm

schwarz  
black  
negro  
nero

Innen Ø  
○ = 2,0 mm  
45011-03

○ = 3,5 mm  
45011-04

○ = 5,0 mm  
45011-05

○ = 6,5 mm  
45011-07

○ = 7,5 mm  
45011-08



TOYNBEE  
45012-00  
Set = 3

Innen Ø  
○ = 4,0 mm  
45012-40

○ = 5,5 mm  
45012-55

○ = 6,5 mm  
45012-65

○ = 7,5 mm  
45012-75



GRUBER, rund  
45014-00  
Set = 4

Innen Ø  
○ = 4,5 mm  
45014-45

○ = 5,5 mm  
45014-55

○ = 6,5 mm  
45014-65

○ = 7,5 mm  
45014-75



GRUBER, oval  
45015-00  
Set = 3

Innen Ø  
○ = 4,5 mm  
45015-45

○ = 5,5 mm  
45015-55

○ = 6,5 mm  
45015-65

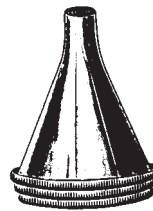

BOUCHERON  
45018-00  
Set = 4

Innen Ø  
○ = 5,0 mm  
45018-50

○ = 6,0 mm  
45018-60

○ = 7,0 mm  
45018-70

○ = 8,0 mm  
45018-80

Ohrspekula  
Ear Specula  
Espéculos auriculares  
Specoli auricolari

○  
45020-01  
Ø 3 mm

○  
45020-02  
Ø 4 mm

○  
45020-03  
Ø 5 mm

○  
45020-04  
Ø 6 mm

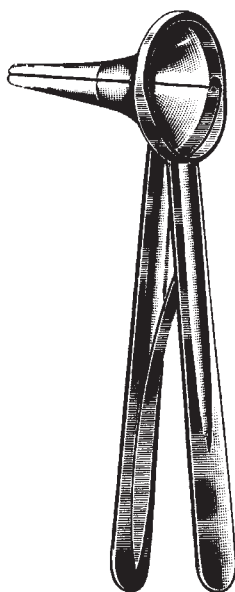

RICHNAU-HOLMGREN



Ohrspekula  
Ear Specula  
Espéculos auriculares  
Specoli auricolari

6,5 mm



45030-06

7,5 mm



45030-07

8,2 mm



45030-08

10 mm



45030-10

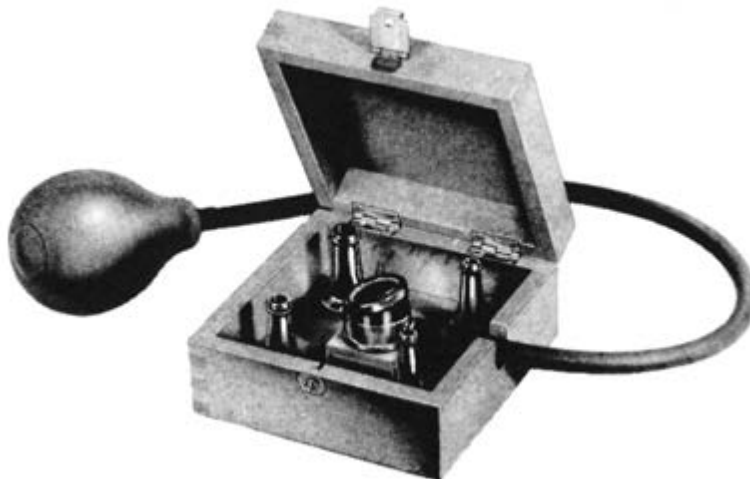

BRUENINGS  
45030-04

**45030-04**

Komplett bestehend aus:  
4 Spekula, Saugkammer mit  
Gebälse, Holzetui

Complete consisting of:  
4 specula, suction head and rubber  
tube with bulb, wooden case

Compuesto de:  
4 espéculos, cámara de aspiración,  
insuflador de goma, en estuche de  
madera

Composta da:  
4 specoli, camera aspirante con  
soffiatrice, scatola di legno

Ersatzteile / spare parts /  
repuestos / pezzi di ricambio

**45036-09**

Lupe / Magnification glass /  
lupa / lente d'ingrandimento

**45036-10**

Saugpumpe / rubber ball /  
pera de goma / soffiatrice di gomma

Ohrspekula  
Ear Specula  
Espéculos auriculares  
Specoli auricolari



6,5 mm Ø



45036-06



7 mm Ø



45036-07



8 mm Ø



45036-08

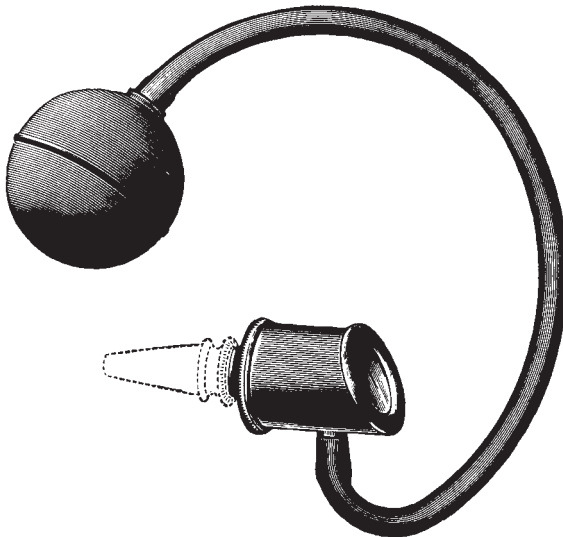

SIEGLE  
45036-03

**45036-03**

Komplett bestehend aus:  
Ohrspekulum, 3 Spekula, 1 Gebläse

Complete consisting of:  
Ear Specula, 1 rubber tube with bulb

Compuesto de:  
Otoscopio con 3 espéculos, insuflador y tubo

Composta da:  
Otoscopio con 3 specoli e 1 insufflatore con tubo

Stimmgabeln  
Tuning Forks  
Diapasones  
Diapason

ALU

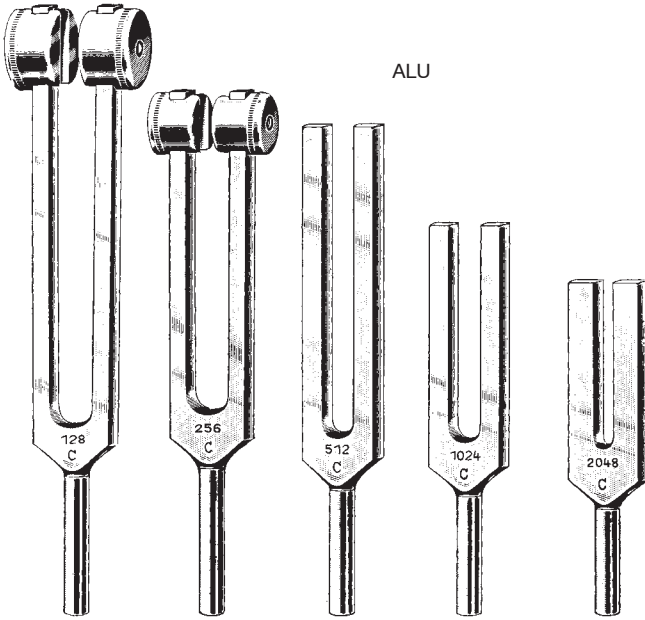

45060-01  
C 128

45060-02  
C<sup>1</sup> 256

45060-03  
C<sup>2</sup> 512

45060-04  
C<sup>3</sup> 1024

45060-05  
C<sup>4</sup> 2048

45061-00  
compl.

STAINLESS

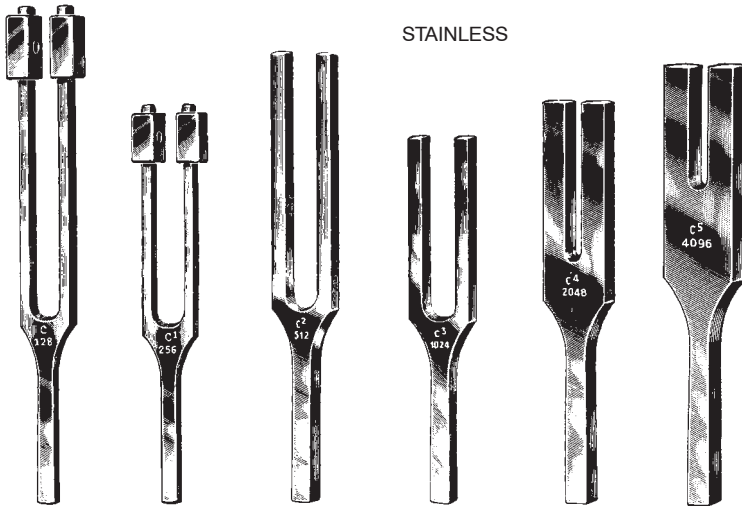

45070-01  
C 128

45070-02  
C<sup>1</sup> 256

45070-03  
C<sup>2</sup> 512

45070-04  
C<sup>3</sup> 1024

45070-05  
C<sup>4</sup> 2048

45070-06  
C<sup>5</sup> 4096

HARTMANN

45071-00  
compl.

Stimmgabeln  
Tuning Forks  
Diapasones  
Diapason



45072-01  
a¹ 440



LUCAE  
45073-01 C 128  
45073-02 C¹ 256  
45073-03 C² 512  
45073-04 C³ 1024  
45073-05 C⁴ 2048  
45073-06 C⁵ 4096



LUCAE  
45074-01  
C 128



45075-00



RYDEL-SEIFFERT  
45076-01 C 128 / C 64

Lärmtrommel, Pulverbläser  
 Noise Apparatus, Powder Blowers  
 Ensordecedor, Lanzapolvero  
 Assorditore, Insoffiatori per polvere



BARANY  
 45080-00

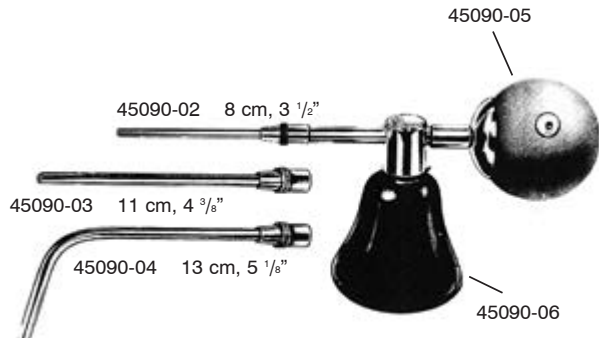

KABIERSKE  
 45090-00 30 ccm  
 komplett mit 3 Kanülen und Gummiball  
 complete with 3 cannulas and rubber bulb  
 completo con 3 cánulas y pera de goma  
 completo con 3 cannule e pera di gomma

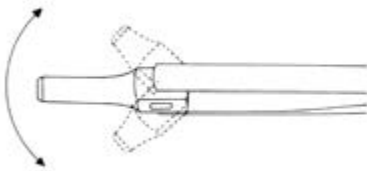

UNIVERSAL  
 45090-08

Komplett mit beweglicher Düse,  
 Schraubflasche 30 ccm und Halbgebläse  
 complete with movable tube, screw bottle  
 30 ccm and rubber bulb  
 completo con tubo móvil botella con rosca  
 30 ccm y pera de goma  
 completo con tubo mobile, bottiglia con  
 filettatura 30 ccm e pera di insufflazione



Luftdusche, Ohrspritze  
 Air Bag, Ear Syringe  
 Insuflador de aire, Jeringa  
 Insoffiatore d'aria, Siringa Auricolare

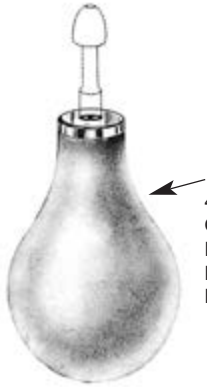

45091-02  
 Gummibirne alleine  
 Rubber bulb only  
 Pera de goma, sola  
 Pera di gomma, sola

POLITZER  
 45091-00 Set  
 incl.  
 45091-03  
 45091-15  
 45091-17  
 45091-22

POLITZER  
 45091-01 Set  
 incl.  
 45091-03  
 45091-04  
 45091-15  
 45091-17  
 45091-22

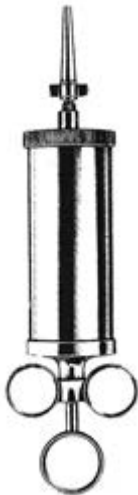

45091-03

45091-04  
4 mm Ø45091-15  
15 mm Ø45091-17  
17 mm Ø45091-22  
22 mm Ø

ml REINER  
 50 45096-50  
 75 45096-75  
 100 45097-10  
 150 45097-15



45097-01

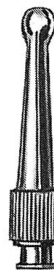

45097-02



45097-03

Spritze, Küretten  
 Syringe, Curettes  
 Jeringa, Curetas  
 Siringa, Curette



45098-01 1 ml  
 45098-02 2 ml  
 45098-05 5 ml  
 45098-10 10 ml  
 45098-20 20 ml  
 45098-50 50 ml

45099-01 1 ml  
 45099-02 2 ml  
 45099-05 5 ml  
 45099-10 10 ml  
 45099-20 20 ml  
 45099-50 50 ml

	Innen Ø	1.5 mm	1.9 mm	2.5 mm	2.7 mm	3.4 mm	4.0 mm	4.5 mm
Küretten Curettes Curetas Curette								
		Fig. 00	0	1	2	3	4	5
stumpf blunt romas smusse		45109-00	45110-00	45110-01	45110-02	45110-03	45110-04	45110-05
scharf sharp cortantes taglianti		45111-00	45112-00	45112-01	45112-02	45112-03	45112-04	45112-05
stumpf blunt romas smusse		45114-00	45115-00	45115-01	45115-02	45115-03	45115-04	45115-05
scharf sharp cortantes taglianti		45116-00	45117-00	45117-01	45117-02	45117-03	45117-04	45117-05

BUCK  
 14,5 cm, 5 3/4"

Ohrkatheter, Parazentese Nadeln, Ohrmesser  
 Catheters, Paracentesis Needles, Ear Knives  
 Cateteres, agujas para paracentesis, Cuchillos auriculares  
 Cateteri, Aghi per paracentesi, Coltelli auricolari

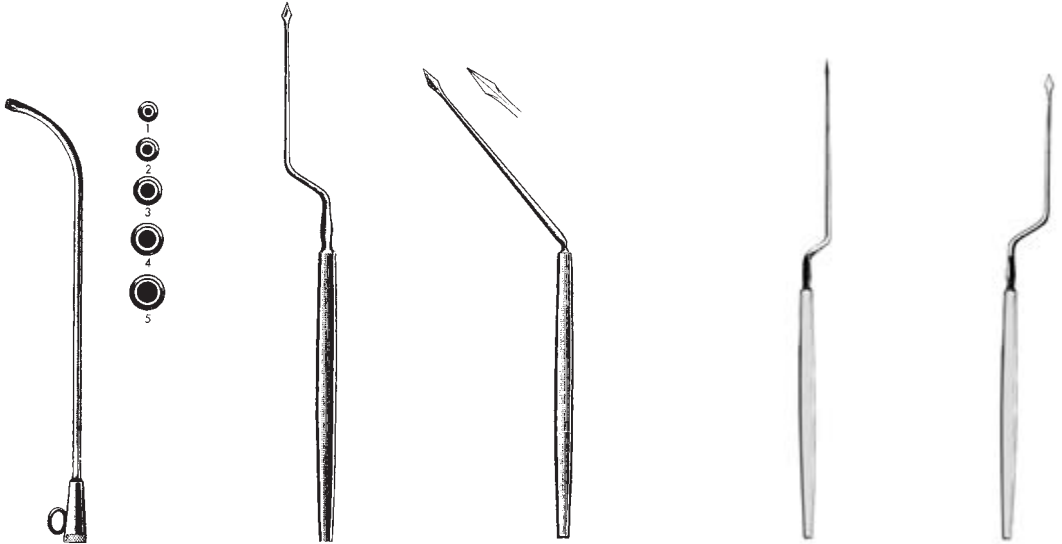

Fig. HARTMANN

- |   |          |        |
|---|----------|--------|
| 1 | 45133-01 | 3,5 mm |
| 2 | 45133-02 | 4,0 mm |
| 3 | 45133-03 | 4,5 mm |
| 4 | 45133-04 | 5,0 mm |
| 5 | 45133-05 | 6,0 mm |

POLTZER  
 45150-18  
 18 cm, 7"

POLTZER  
 45151-16  
 16,5 cm, 6 1/2"

LUCAE  
 45152-01  
 18 cm, 7"

LUCAE  
 45152-02  
 18 cm, 7"

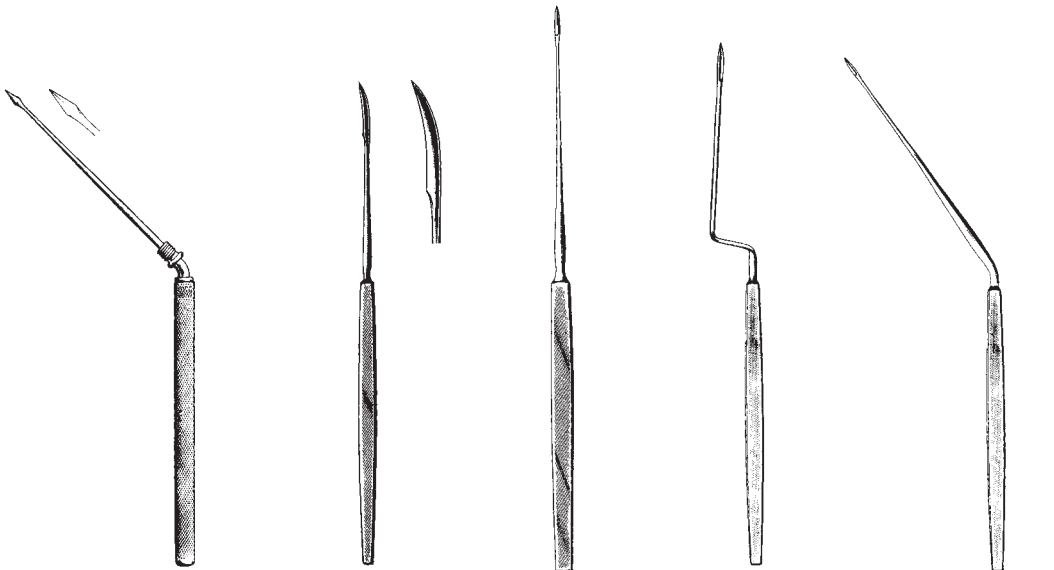

POLTZER  
 45153-16  
 16 cm, 6 1/4"

POLTZER  
 45160-15  
 15 cm, 6"

SEXTON  
 45162-18  
 18 cm, 7"

SEXTON  
 45164-17  
 17 cm, 6 3/4"

SEXTON  
 45165-17  
 17 cm, 6 3/4"



Löffel, Schlingen, Häkchen  
 Ear spoons, Loops, Hooklets  
 Cucharas, Asas, Ganchitos  
 Cucchiai, Anse, Uncinetti

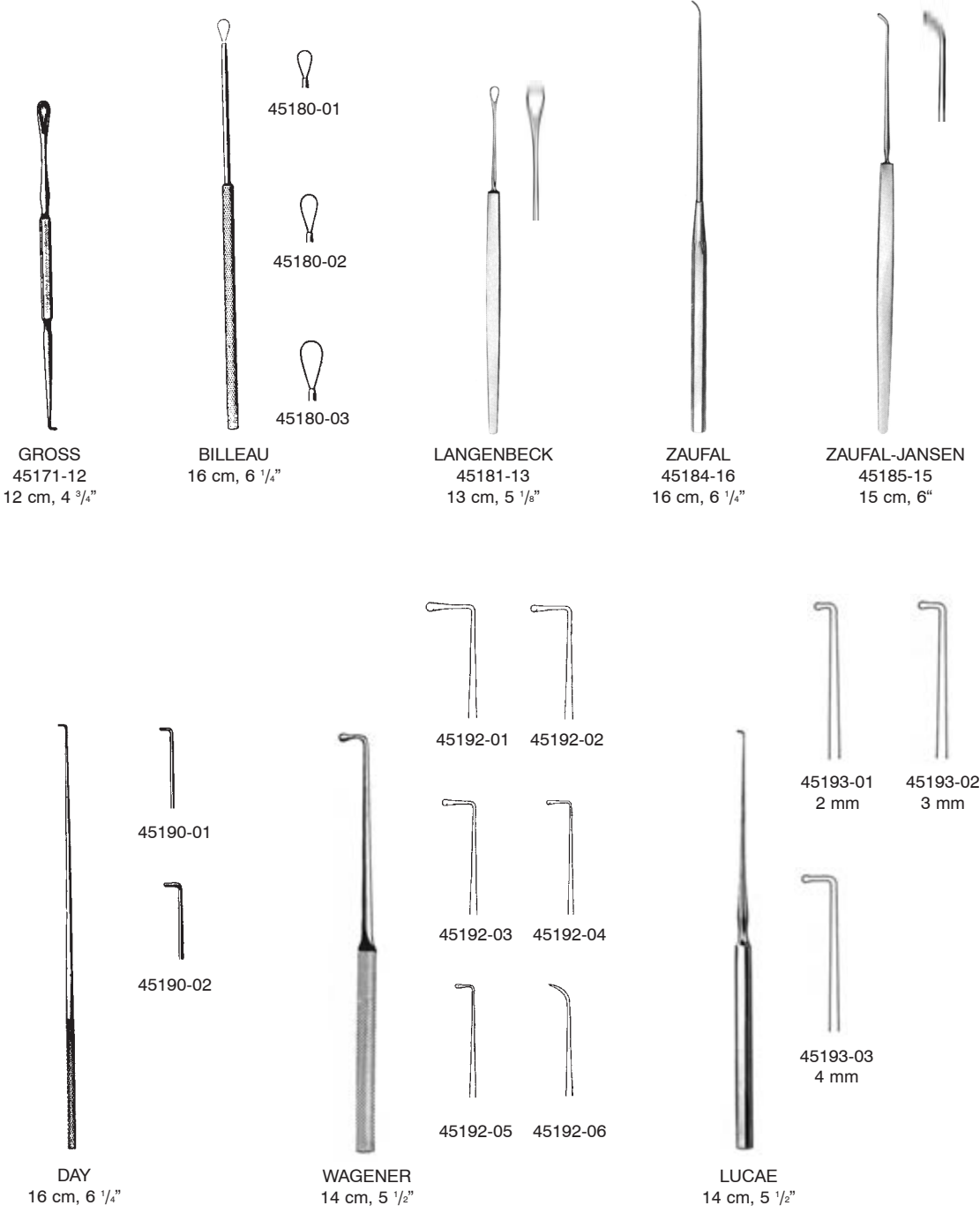

**GROSS**  
 45171-12  
 12 cm, 4 3/4"

**BILLEAU**  
 16 cm, 6 1/4"

**LANGENBECK**  
 45181-13  
 13 cm, 5 1/8"

**ZAUFAL**  
 45184-16  
 16 cm, 6 1/4"

**ZAUFAL-JANSEN**  
 45185-15  
 15 cm, 6"

45180-01

45180-02

45180-03

45192-01

45192-02

45192-03

45192-04

45192-05

45192-06

45193-01  
 2 mm

45193-02  
 3 mm

45193-03  
 4 mm

45190-01

45190-02

**DAY**  
 16 cm, 6 1/4"

**WAGENER**  
 14 cm, 5 1/2"

**LUCAE**  
 14 cm, 5 1/2"

Schlingen, Pinzetten  
 Loops, Dressing Forceps  
 Asas, Pinzas  
 Anse, Pinze



SHAPLEIGH  
 13 cm, 5 1/8"

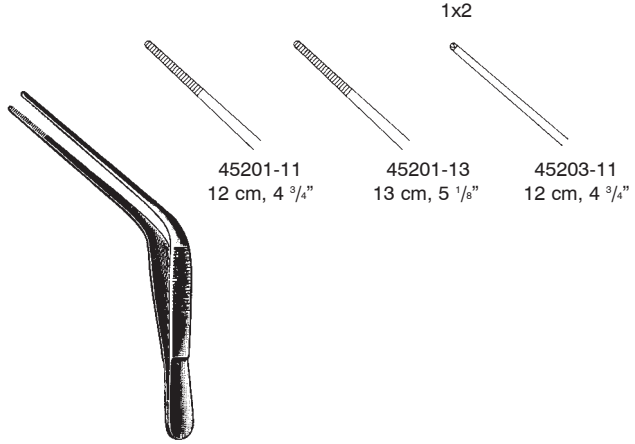

WILDE (TROELTSCH)



LUCAE  
 45206-14  
 14 cm, 5 1/2"



LUCAE  
 16 cm, 6 1/4"



COTTLE  
 45208-14  
 14 cm, 5 1/2"

Polypenschnürer, Ohrzängchen  
Snares, Ear Forceps  
Cierra-nudos, Pinzas auriculares  
Serranodi, Pinze auricolari



KRAUSE  
45220-16  
16 cm, 6 1/4"



WILDE  
45222-17  
17 cm, 6 3/4"



45225-02  
doz./doc./dozz.  
0,2 mm

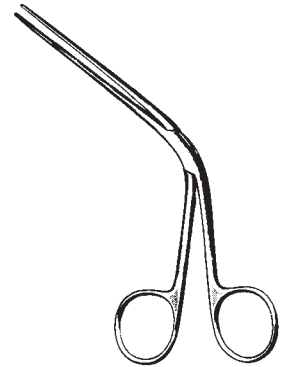

TILLEY  
45243-14  
14 cm, 5 1/2"



LITTAUER  
45245-12  
12 cm, 4 3/4"

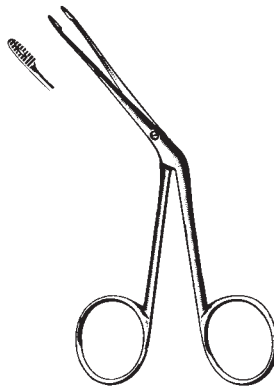

HARTMANN  
45246-12  
12 cm, 4 3/4"

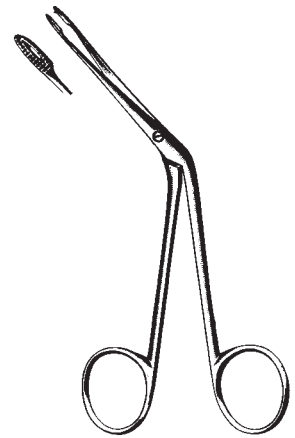

HARTMANN  
45246-14  
14 cm, 5 1/2"

Fremdkörperheber, Fremdkörperzängchen  
 Foreign Body Levers, Ear Polypus Forceps  
 Elevadores para cuerpos extraños, Pinzas para pólipos  
 Leve per corpi estranei, Pinze per polipi



QUIRE  
 45251-10  
 10 cm, 4"

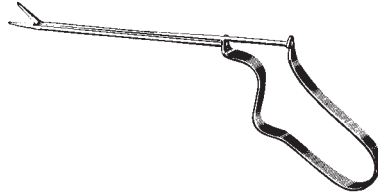

BUCK  
 45253-11  
 11 cm, 4 3/8"

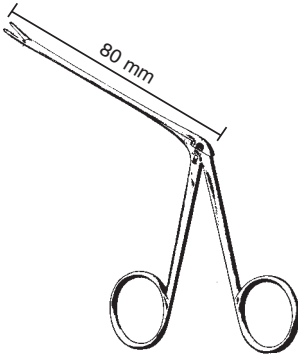

45255-08 - 45275-08



HARTMANN-WULLSTEIN  
 45255-08  
 8,5 cm, 3.4"

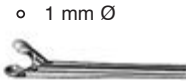

o 1 mm Ø  
 HARTMANN-WULLSTEIN  
 45257-08  
 8,5 cm, 3.4"



HARTMANN  
 45261-08 8,5 cm, 3.4"  
 45261-14 14,0 cm, 5 1/2"  
 45261-16 16,0 cm, 6 1/4"



HARTMANN  
 45263-08 8,5 cm, 3.4"  
 45263-14 14,0 cm, 5 1/2"



HARTMANN  
 45265-08  
 8,5 cm, 3.4"



Ø mm HARTMANN  
 2,0 45267-20 8,5 cm, 3.4"  
 2,5 45267-25 8,5 cm, 3.4"  
 3,0 45267-30 8,5 cm, 3.4"



○ 3 mm Ø  
 HARTMANN  
 45269-30  
 8,5 cm, 3.4"



STRUEMPEL  
 45271-08 8,5 cm, 3.4"  
 2,5x5 mm



HARTMANN  
 45273-08  
 8,5 cm, 3.4"



○ 2 mm Ø  
 HARTMANN-HOFFMANN  
 45275-08  
 8,5 cm, 3.4"

Mikro-Ohrscheren, Mikro-Ohrzangchen  
 Micro Ear Scissors, Micro Ear Forceps  
 Tijeras auriculares micro, Pinzas auriculares micro  
 Forbici auricolari micro, Pinze auricolari micro

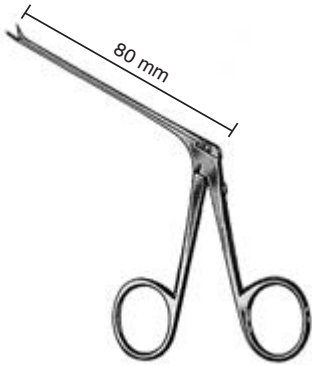

45310-40 - 45322-70



**A**  
 BELLUCCI  
 45310-40  
 micro mini  
 4 mm



**A**  
 BELLUCCI  
 45312-55  
 micro standard  
 5,5 mm



**D**  
 BELLUCCI  
 45313-55  
 micro standard  
 5,5 mm



**B**  
 BELLUCCI  
 45315-55  
 micro standard  
 5,5 mm



**C**  
 BELLUCCI  
 45317-55  
 micro standard  
 5,5 mm



**A**  
 SHEA  
 45320-70  
 7,0 mm



**C**  
 SHEA  
 45321-70  
 7,0 mm



**B**  
 SHEA  
 45322-70  
 7,0 mm

- A:** gerade / straight / recta / retta  
**B:** rechts / right / derecha / destra  
**C:** links / left / izquierda / sinistra  
**D:** aufgebogen / curved up / curva in alto / curva hacia arriba  
**E:** nach unten gebogen / curved down / curva in basso / curva hacia abajo



45350-40 - 45360-35



**A**  
 45350-40  
 4 mm



**A**  
 45350-70  
 7 mm



**A**  
 45352-40  
 4 mm



**C**  
 45353-60  
 6 mm



**B**  
 45355-60  
 6 mm



**D**  
 45357-40  
 4 mm



**E**  
 45359-40  
 4 mm



**A**  
 45360-35  
 3,5 mm

Mikro-Ohrzängchen, Hammerkopfstanze

Micro Ear Forceps, Malleus punch

Pinzas auriculares micro, Pinza saca-bocadas para cabeza de martillo

Pinze auricolari micro, Pinze taglianti per testa del martelletto taglio a scalpello

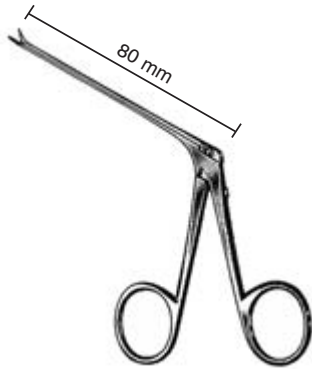

45362-45 - 45383-30



**A**  
45362-45  
4,5 mm



**C**  
45363-45  
4,5 mm

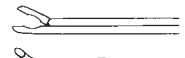

**B**  
45365-45  
4,5 mm

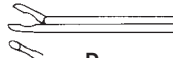

**D**  
45367-50  
5,0 mm



**E**  
45369-50  
5,0 mm

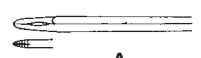

**A**  
GREVEN  
45370-50  
5,0 mm



McGEE  
45371-40  
0,8x4,0 mm



COS  
45373-30  
1,8x0,8x3,0 mm



JUERS  
45375-60  
6,0 mm

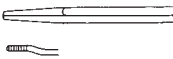

JUERS  
45377-60  
6,0 mm



**C**  
HAUGH  
45381-30  
45° 3 mm



**B**  
HAUGH  
45383-30  
45° 3 mm

**A:** gerade / straight / recta / retta

**B:** rechts / right / derecha / destra

**C:** links / left / izquierda / sinistra

**D:** aufgebogen / curved up / curva in alto / curva hacia arriba

**E:** nach unten gebogen / curved down / curva in basso / curva hacia abajo

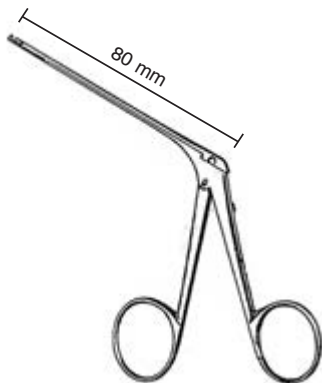

DIETER  
45385-01 - 45387-02

micro ø 1,3 mm

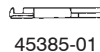

45385-01

aufwärts  
upward  
arriba  
in alto

mini ø 1,8 mm

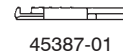

45387-01



45385-02

abwärts  
downward  
abajo  
in basso

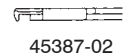

45387-02

Mikro-Ohrzängchen  
Micro Ear Forceps  
Pinzas auriculares micro  
Pinze auricolari micro



45390-35  
0,8 x 3,5 mm



45390-50  
1 x 5 mm



45391-35  
0,8 x 3,5 mm



45392-35  
0,8 x 3,5 mm



45393-50  
1 x 5 mm



45394-50  
1 x 5 mm

Mikro-Ohrzängchen  
 Micro Ear Forceps  
 Pinzas auriculares micro  
 Pinze auricolari micro



WULLSTEIN



45400-01  
 0,9 x 1 mm



45400-02  
 0,8 x 1,3 mm



45400-03  
 1 mm



45401-25  
 1,7 x 2,5 mm



45402-10  
 0,9 x 1 mm



45403-13  
 0,8 x 1,3 mm



45404-13  
 0,8 x 1,3 mm



Mikro-Ohrscheren  
Micro Ear Scissors  
Tijeras auriculares micro  
Forbici auricolari micro



WULLSTEIN



45410-01



45411-01



45412-01



45413-01



45414-01

Messer  
Knives  
Cuchillos  
Coltelli



SCHUKNECHT  
45701-01  
16 cm, 6 1/4"



SCHUKNECHT  
45701-02  
16 cm, 6 1/4"



SCHUKNECHT  
45703-15  
15,5 cm, 6"



WULLSTEIN  
45704-15  
15,5 cm, 6"



TABB  
45705-15  
15,5 cm, 6"



PLESTER  
45706-35  
15,5 cm, 6"



45709-10  
Ø 1,0 mm



45709-14  
Ø 1,4 mm



45709-16  
Ø 1,6 mm



45709-20  
Ø 2,0 mm



45709-26  
Ø 2,6 mm



45709-28  
Ø 2,8 mm



45709-30  
Ø 3,0 mm



ROSEN  
45709-10 - 45709-30  
16 cm, 6 1/4"

Nadeln und Häkchen  
Needles and Hooks  
Agujas y Ganchos  
Aghi e uncini



16 cm  
6 1/4"

BARBARA  
45710-15

BARBARA  
45711-15

BARBARA  
45713-15

BARBARA  
45715-17



25°  
SHAMBAUGH



45°  
SHAMBAUGH



90°  
SHAMBAUGH



BARBARA  
45725-05=0,5 mm  
45725-10=1,0 mm

mm  
0,3  
0,6  
1,0  
1,2  
1,5  
2,0  
2,5

45720-03  
45720-06  
45720-10

45722-03  
45722-06  
45722-10  
45722-12  
45722-15  
45722-20  
45722-25

45724-03  
45724-06  
45724-10  
45724-12  
45724-15  
45724-20  
45724-25



45730-03 - 45747-10  
15,5 cm, 6"



mm  
0,3  
0,6  
1,0

90°  
45730-03  
45730-06  
45730-10



90°  
45732-03  
45732-06  
45732-10



mm  
0,5  
1,0

McGEE  
45733-05  
45733-10



McGEE  
45735-05  
45735-10



BARBARA  
45736-15  
15,5 cm, 6"



ROSEN  
45737-15  
15,5 cm, 6"



mm  
0,3  
0,6  
1,0

25°  
45741-03  
45741-06  
45741-10



25°  
45743-03  
45743-06  
45743-10



45°  
45745-03  
45745-06  
45745-10



45°  
45747-03  
45747-06  
45747-10

Dissektoren, Küretten, Elevatoren, Mikro-Meßsonde  
 Dissectors, Curettes, Elevators, Micro measuring rod  
 Disectores, Curetas, Elevadores, Sonda para mesurar  
 Dissettori, Curette, Elevatori, Sonda auricolare per misurare

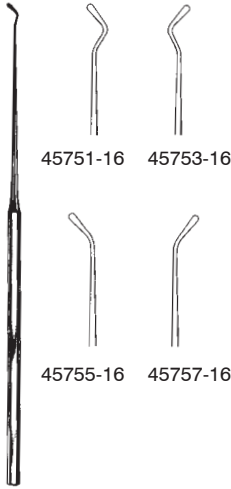

45751-16 45753-16

45755-16 45757-16

FISCH  
 45751-16 - 45757-16  
 16 cm, 6 1/4"

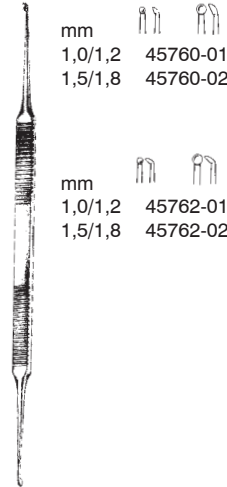

mm 1,0/1,2 45760-01  
 1,5/1,8 45760-02

mm 1,0/1,2 45762-01  
 1,5/1,8 45762-02

HOUSE  
 45760-01 - 45762-02  
 15 cm, 6"

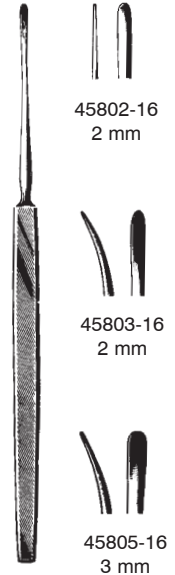

45802-16  
 2 mm

45803-16  
 2 mm

45805-16  
 3 mm

LEMPERT  
 45802-16 - 45805-16  
 16 cm, 6 1/4"

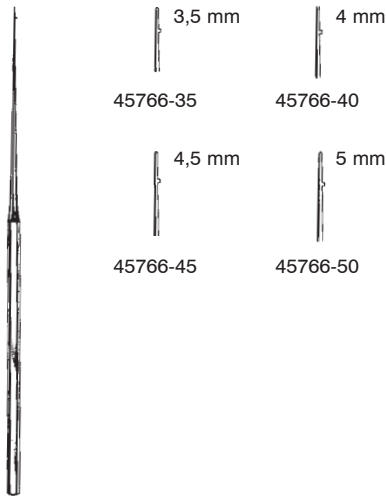

3,5 mm 45766-35  
 4 mm 45766-40  
 4,5 mm 45766-45  
 5 mm 45766-50

HOUSE  
 45766-35 - 45766-50  
 16 cm, 6 1/4"

6 mm



LEMPERT  
 45807-20  
 20,5 cm, 8"

Nasenspekula  
Nasal Specula  
Espéculos nasales  
Specoli nasali



THUDICHUM  
47050-01 - 47050-07

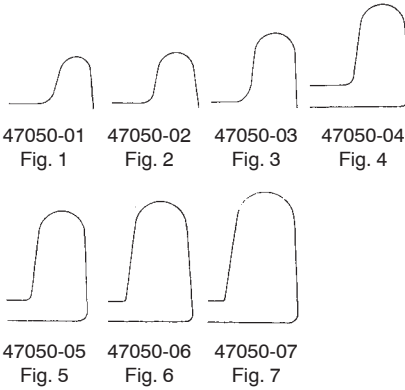

VOLTOLINI  
47060-01 - 47060-03



HARTMANN-HALLE  
47102-01 - 47102-03  
15 cm, 6"

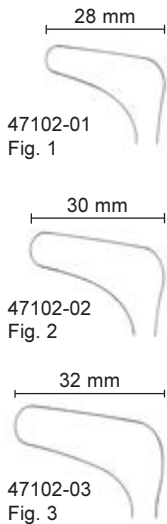

leichtes Modell  
lightweight  
mod. ligero  
mod. leggero

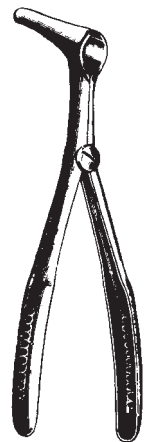
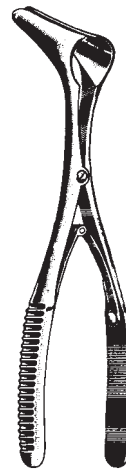

	Mod. WIEN	
Baby, bébé	47112-01	25 mm
Kind, child, niño, bamb.	47112-02	30 mm
Erwachs., Adult, adulto	47112-03	35 mm

Mod. WIEN  
47113-03

Nasenspekula  
Nasal Specula  
Espéculos nasales  
Specoli nasali



HARTMANN  
16 cm, 6 1/4"

30 mm

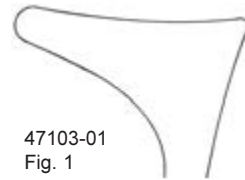

47103-01  
Fig. 1

33 mm

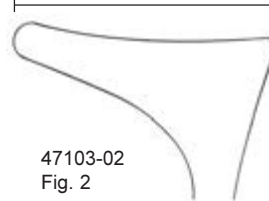

47103-02  
Fig. 2

35 mm

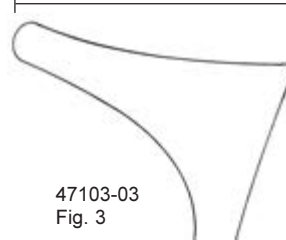

47103-03  
Fig. 3

Nasenspekula, Kehlkopfspiegel  
 Nasal Specula, Laryngeal Mirrors  
 Espéculos nasales, espejos laríngeos  
 Specoli nasali, Specchi laringei

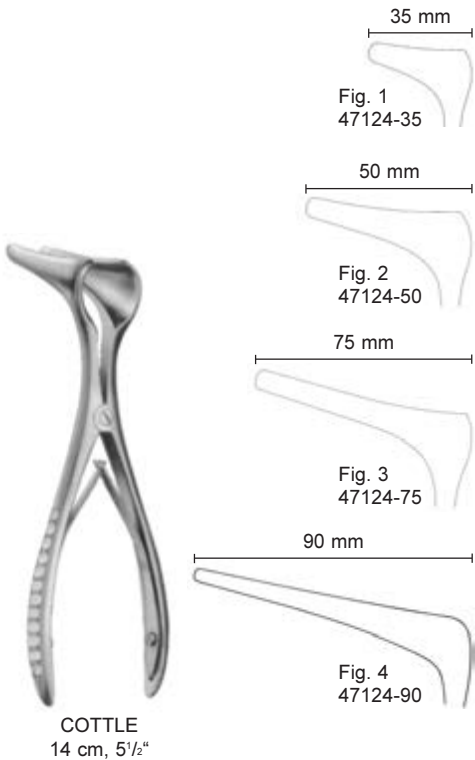
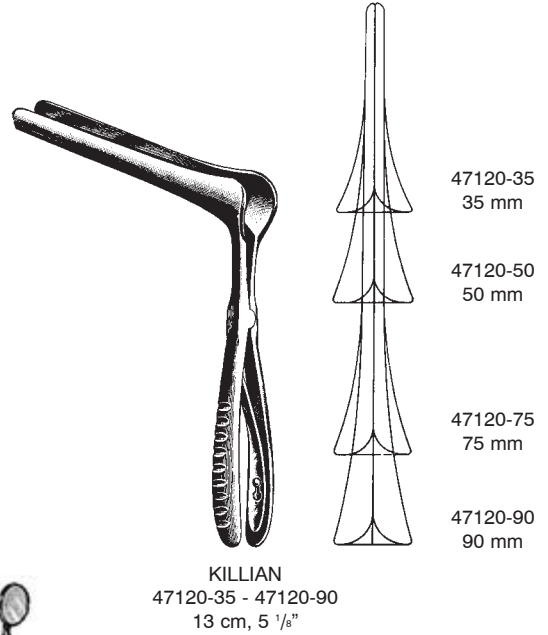
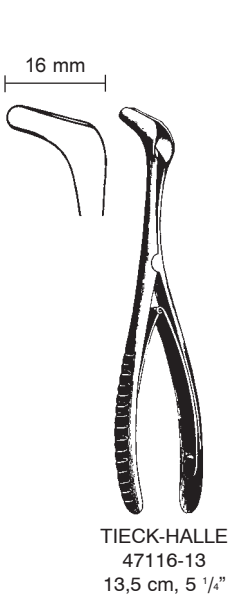

Nasenpinzetten, Polypenzange  
 Ear Dressing Forceps, Ear Polypus Forceps  
 Pinzas auriculares, Pinzas para pólipos  
 Pinze auricolari, Pinze per polipi

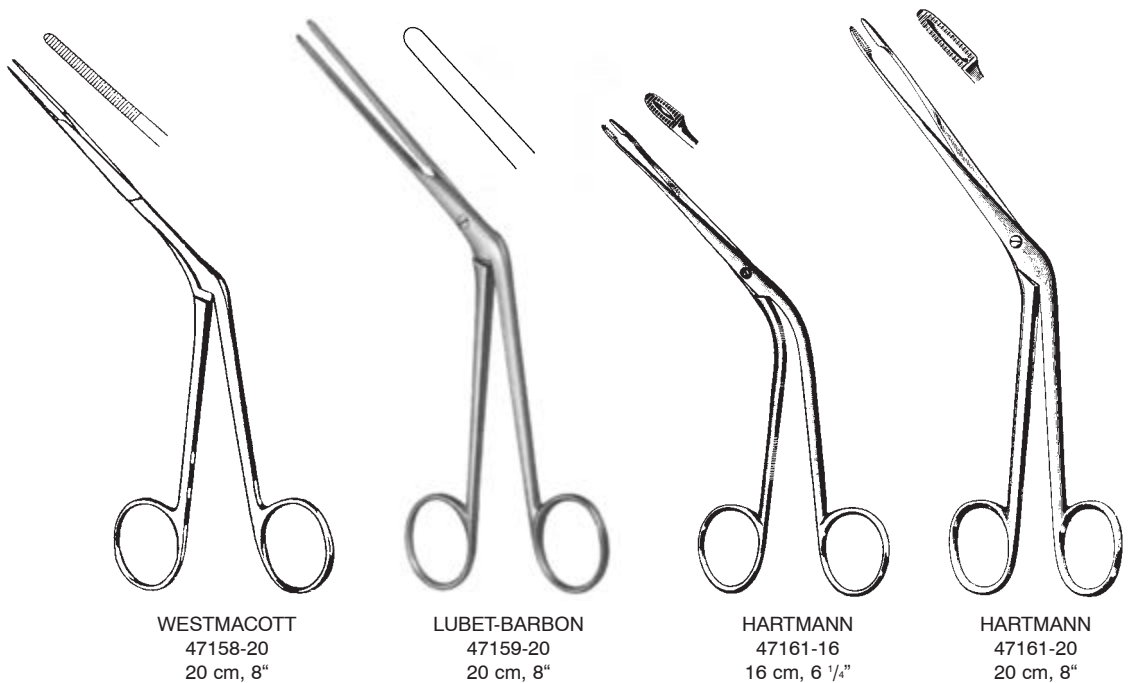
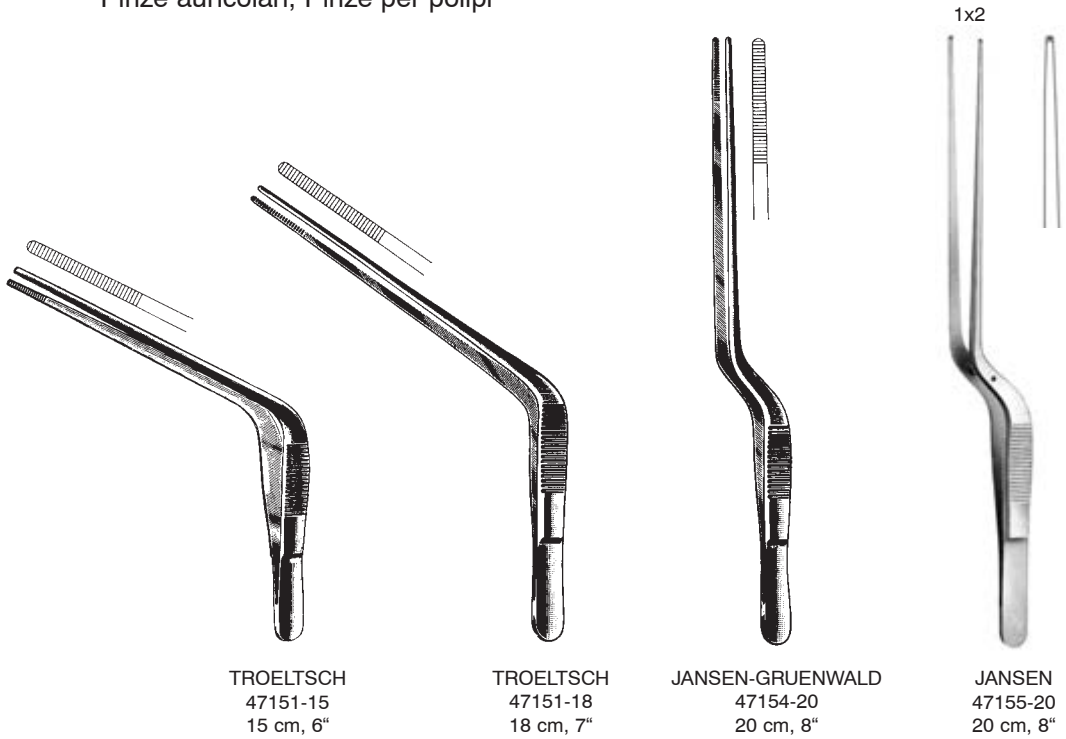



Polypenzangen, Septumzangen  
 Nasal Polypus and Septum Forceps  
 Pinzas para pólipos y para el tabique nasal  
 Pinze per polipi, Pinze per il setto nasale

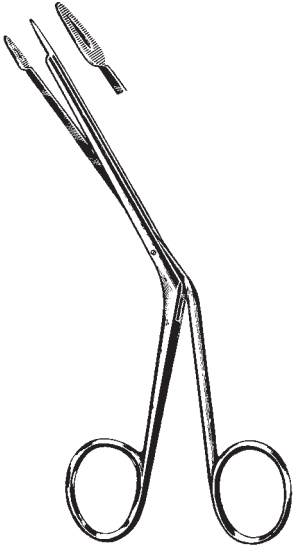

LITTAUER  
 47167-18  
 18 cm, 7"



HEYMANN-KNIGHT  
 47169-18  
 18 cm, 7"

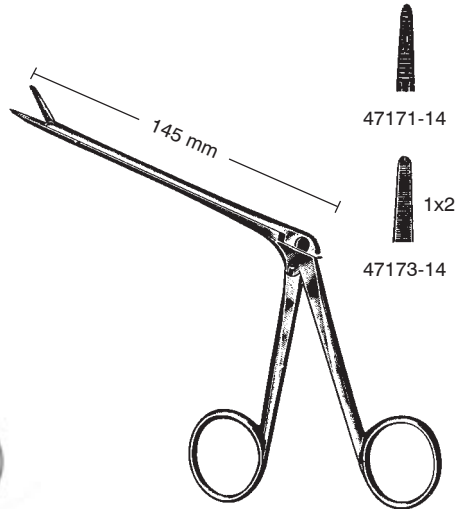

NOYES  
 47171-14 - 47173-14  
 14,5 cm, 5 3/4"

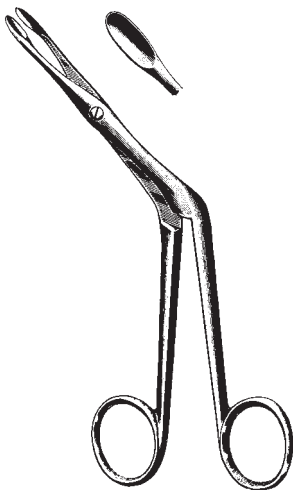

HEYMANN  
 47181-18  
 18 cm, 7"



KNIGHT  
 47185-18  
 18 cm, 7"



BRUENINGS  
 47191-01 - 47191-04  
 19 cm, 7 1/2"

Scharfe Nasenzangen, Septumzangen  
 Nasal Cutting Forceps, Septum Forceps  
 Pinzas cortantes nasales y para el tabique nasal  
 Pinze taglienti nasali, Pinze per il setto nasale



GRAIG  
 47192-16  
 18 cm, 7"

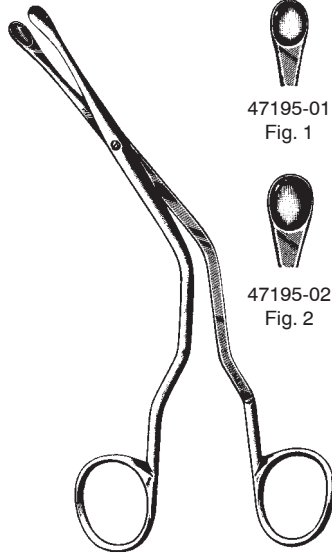

LUC  
 47195-01 - 47195-05  
 19 cm, 7 1/2"

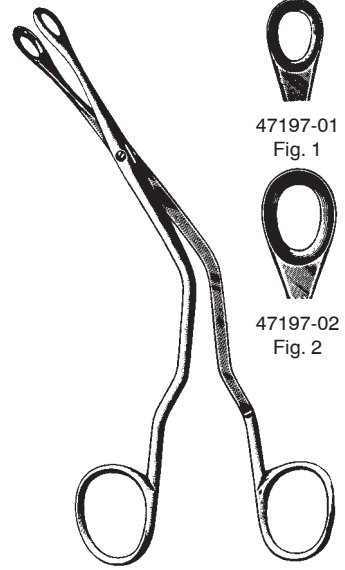

LUC  
 47197-01 - 47197-02  
 19 cm, 7 1/2"

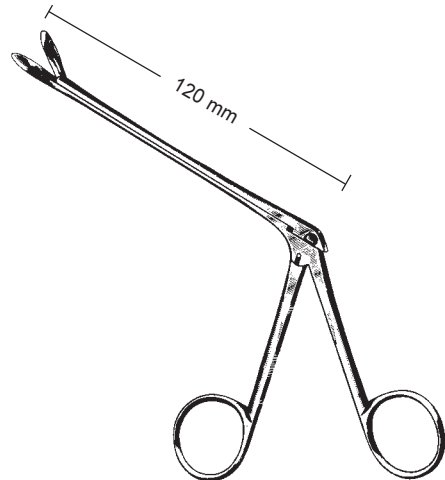
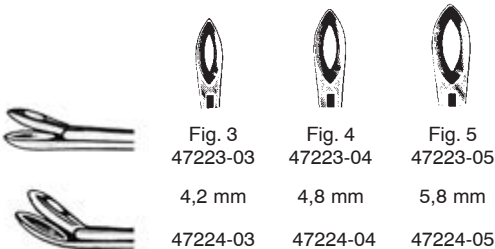
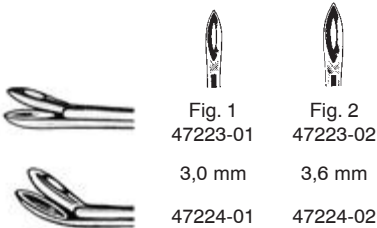

WEIL-BLAKESLEY  
 47223-01 - 47224-05

Scharfe Nasenzangen  
 Nasal Cutting Forceps  
 Pinzas cortantes nasales  
 Pinze taglianti nasali

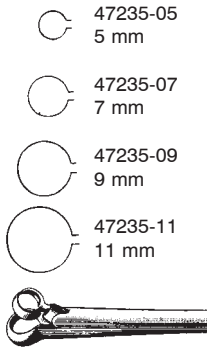

HARTMANN

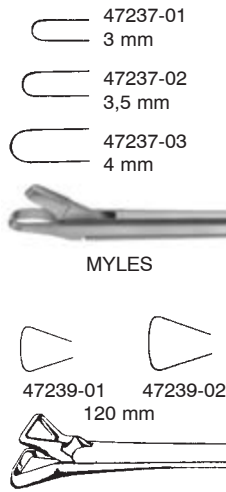

MYLES

SCHMEDEN

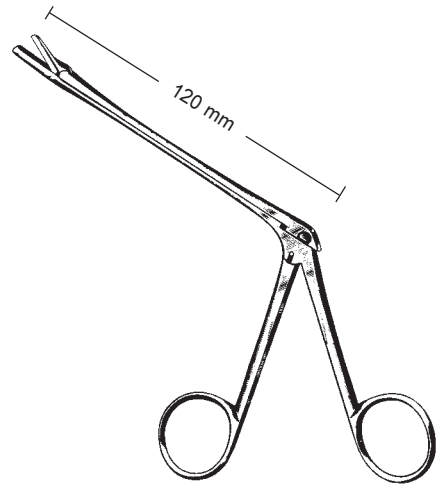

STRUYCKEN  
47240-19

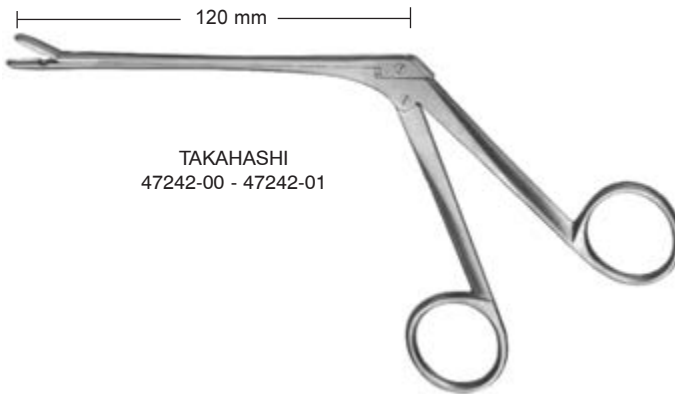

TAKAHASHI  
47242-00 - 47242-01

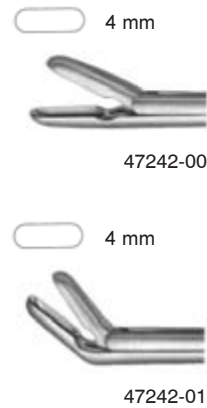

47242-01

Scharfe Nasenzangen, Septumzange, Kieferhöhlenstanze  
 Nasal Cutting Forceps, Septum Forceps, Antrum Punch Forceps  
 Pinzas cortantes nasales, Pinza para magullar tabique, Pinzas cortantes para maxilares  
 Pinze taglianti nasali, Pinza per ammaccare il setto, Pinze taglianti per seno mascellare



RUBIN  
 47251-21  
 21 cm, 8 1/4"

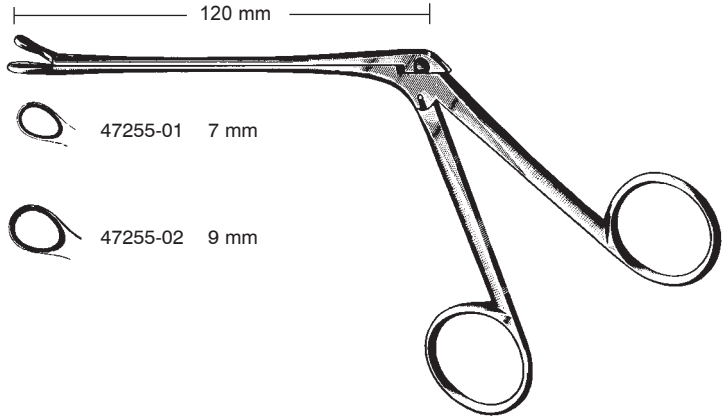

WATSON-WILLIAMS  
 47255-01



CAPLAN  
 47256-20  
 20 cm, 8"



KERRISON  
 3x3 mm 47303-03  
 4x4 mm 47303-04  
 5x5 mm 47303-05  
 6x6 mm 47303-06  
 17 cm, 6 3/4"

Kieferhöhlenstanze, Nasenschere  
 Antrum Punch Forceps, nasal scissors  
 Pinzas cortantes para maxilares, tijera nasal  
 Pinze sfenoidali, forbici nasali



47304-01 5x3,5 mm

47304-03 5x4 mm



47304-02 5x3,5 mm

47304-04 5x4 mm

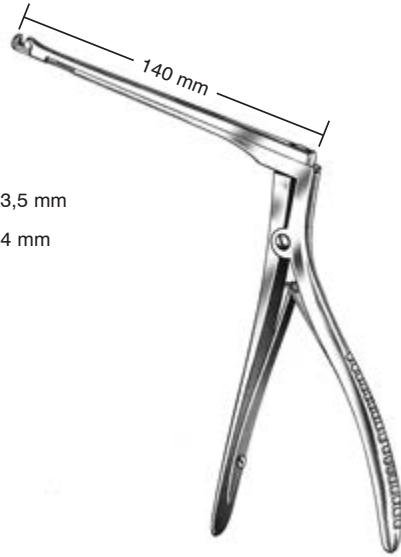

HAJEK-KOFLER  
 47304-01 - 47304-04

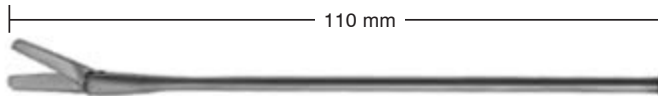

47305-02  
 rechts gebogen  
 right curved  
 curva a la derecha  
 curva a destra



47305-03  
 links gebogen  
 left curved  
 curva a la izquierda  
 curva a sinistra



47305-01  
 gerade  
 straight  
 recta  
 retta

Knochenstanze, Septumzangen

Punches, Septum Forceps

Pinzas osteótomos, Pinzas para el tabique nasal

Pinze osteotomi, Pinze per il setto nasale

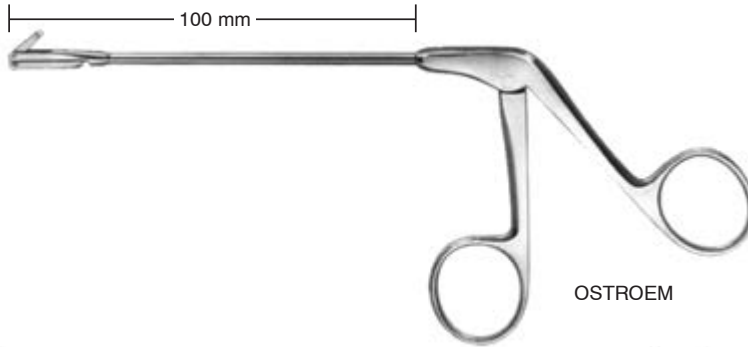

47315-00  
2 mm  
oben schneidend  
up cutting  
cortante por arriba  
tagliente in alto



47316-00  
2 mm  
rechts schneidend  
right cutting  
cortante a la derecha  
tagliente a destra



47317-00  
2 mm  
links schneidend  
left cutting  
cortante a la izquierda  
tagliente a sinistra



CITELLI  
47311-10 1,0 mm  
47311-25 2,5 mm  
47311-30 3,0 mm



MIDDLETON-JANSEN  
47323-19  
19 cm, 7 1/2"



MIDDLETON-JANSEN  
47325-19  
19 cm, 7 1/2"

Kieferhöhlenstanze, Sinuskopie-Zangen  
 Antrum Punch Forceps, Sinuscopy forceps  
 Pinzas cortantes para maxilares, Pinzas para senoscopia  
 Pinze sfenoidali per seno mascellare, Pinze per sinuscopia



HAJEK-KOFLER  
 47316-16  
 3,5 mm

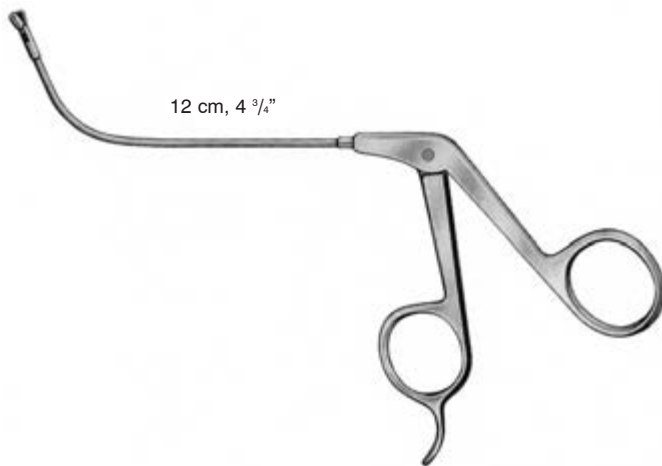

Maul  
 jaw  
 boca  
 morso

horizontal öffnend  
 horizontal cutting  
 abierta horizontal  
 apertura orizzontale

vertikal öffnend  
 vertical cutting  
 abierta vertical  
 apertura verticale

65° ○ 3 mm rund  
 70° ○ } oval  
 90° ○ }  
 110° ○ }

47317-65  
 47317-70  
 47317-90  
 47317-11

47318-65  
 47318-70  
 47318-90  
 47318-11

Zirkular Stanze  
Circular Forceps  
Pinza circular  
Pinza circolare



47319-35 3,5 mm  
47319-45 4,5 mm



Spülkanülen, Stirnhöhlendilatator  
 cannulas, Frontal sinus bougies  
 cánulas, Dilatador para el seno  
 cannulas, Dilatatore per seno frontale

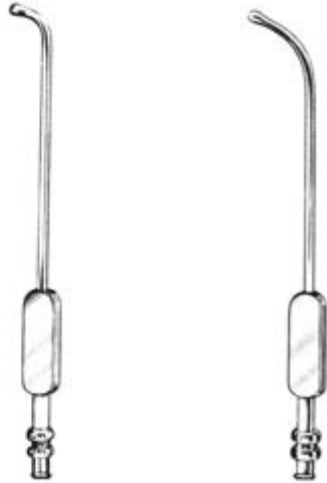

EICKEN (KILLIAN)  
 14,5 cm, 5 <sup>3</sup>/<sub>4</sub>"  
 Ø

47331-20	2,0 mm	47332-20
47331-25	2,5 mm	47332-25
47331-30	3,0 mm	47332-30
47331-40	4,0 mm	47332-40



Ø mm RITTER-HALLE  
 2,5 47342-25  
 3,0 47342-30  
 4,0 47342-40

Kiefer- und Stirnhöhlen-Spülkanülen, Saugraspatorium  
Antrum and Frontal Sinus Wash Cannulas, Suction Raspatory  
Cànulas lavadoras para seno maxilar y seno frontal, Legra de succión  
Cannule per seno mascellare e seno frontale, Raspatorio con aspiratore



KILLIAN  
Ø 1,5 mm  
47345-15



GUILEN  
19 cm, 7 1/2"  
47347-20

Polypenschnürer  
Nasal Polypus Snares  
Polipótomos  
Serranodi



KRAUSE-VOSS  
47350-26  
26 cm, 10 1/4"



KRAUSE  
47351-26  
26 cm, 10 1/4"

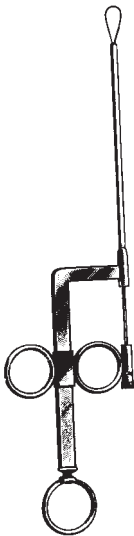

WILDE  
47352-24  
24 cm, 9 1/2"



Bündel mit 12 Stück  
Bundle with 12 pieces  
12 piezas atados  
confezione di 12 pezzi

47355-03 0,3 mm

Nasenmesser  
Nasal Knives  
Bisturies nasales  
Coltelli nasali



JOSEPH  
47370-16 - 47373-16  
16 cm, 6 1/4"



47370-16 47371-16  
stumpf, blunt,  
romos, smussi



47372-16 47373-16  
spitz, pointed,  
agudos, acuti



FREER  
47374-16  
16,5 cm, 6 1/2"



FREER  
47375-19  
19 cm, 7 1/2"



JOSEPH  
47375-16  
16,5 cm, 6 1/2"

Nasenplastik- und Operationsmesser, Sichelmesser, Küretten  
 Rhinoplastic and Nasal Knives, Septum Sickle Knives, Curettes  
 Bisturries para plastica y operaciones de la nariz, Bisturries para el tabique nasal, Curetas  
 Bisturi per la plastica ed operazioni nasali, coltelli per setto, Curette

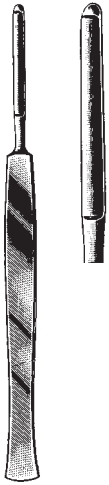

JOSEPH  
47376-16  
16 cm, 6 1/4"

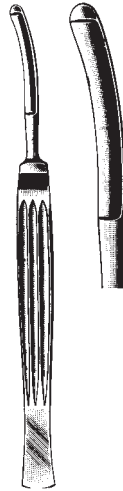

CONVERSE  
47379-16  
16 cm, 6 1/4"



COTTLE  
47380-15  
15 cm, 6"



COTTLE  
47382-15  
15 cm, 6"



JOSEPH  
47384-15  
15 cm, 6"



JOSEPH  
47385-15  
15 cm, 6"



REDA  
19 cm, 7 1/2"



47386-01  
spitz  
pointed  
agudo  
acuto



47386-02  
stumpf  
blunt  
romo  
smusso



ANTRUM  
19 cm, 7 1/2"



47387-01  
vorwärts schneidend  
forward cutting  
corte hacia adelante  
taglio in avanti



47387-02  
rückwärts schneidend  
backward cutting  
corte hacia atras  
taglio retrograde

Schwingmesser  
 Septum Swivel Knives  
 Bisturies para el tabique nasal  
 Coltelli per setto



BALLENGER  
 47390-03 - 47392-05  
 20 cm, 8"



47390-03  
 3 mm



47390-04  
 4 mm



47390-05  
 5 mm



47392-03  
 3 mm



47392-04  
 4 mm



47392-05  
 5 mm



Septum Elevatoren  
 Septum Elevators  
 Elevadores para el tabique  
 Elevatori per setto

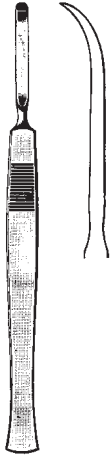

47410-04  
 4 mm

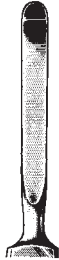

47410-05  
 5 mm



HALLE  
 47410-16  
 16.5 cm, 6 1/2"



JOSEPH  
 47411-16  
 16 cm, 6 1/4"

McKENTY  
 47410-04 - 47410-05  
 15 cm, 6"

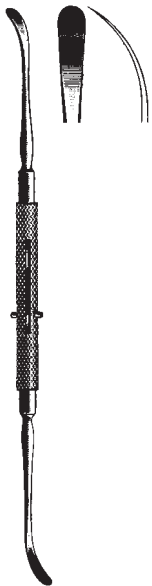

ROGER  
 47413-19  
 19 cm, 7 1/2"



MASING  
 47414-21  
 22 cm, 8 3/4"



FREER  
 47415-18  
 18 cm, 7"



FREER  
 47417-19  
 19 cm, 7 1/2"

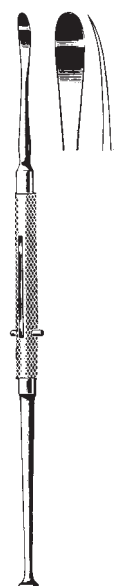

FREER  
 47419-19  
 19 cm, 7 1/2"

Septum Elevatoren  
 Septum Elevators  
 Elevadores para el tabique  
 Elevatori per setto



KILLIAN  
 47420-01  
 18,5 cm, 7 1/4"



PIERCE  
 47420-02  
 21 cm, 8 1/4"



SINUS  
 47420-03  
 18 cm, 7"



PENNINGTON  
 47420-04  
 21 cm, 8 1/4"



McKENTY  
 47420-20  
 22 cm, 8 3/4"



HOWARTH  
 47421-21  
 21,5 cm, 8 1/2"



Septum Elevatoren  
 Septum Elevators  
 Elevadores para el tabique  
 Elevatori per setto



COTTLE  
 47421-23  
 23 cm, 9"



COTTLE JOSEPH  
 47422-22  
 22 cm, 8 3/4"



COTTLE  
 47423-22  
 22 cm, 8 3/4"

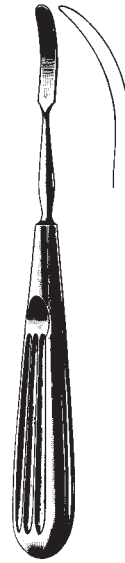

COTTLE  
 47424-16  
 16 cm, 6 1/4"



COTTLE  
 47425-19  
 19 cm, 7 1/2"



KILLIAN  
 47426-22  
 22 cm, 8 3/4"



HAJEK-BALLENGER  
 47428-21  
 22 cm, 8 3/4"



BALLENGER  
 47430-22  
 22 cm, 8 3/4"



FREER  
 47450-04  
 15 cm, 6"



FREER  
 47451-04  
 15 cm, 6"

Osteotome, Knorpelquetscher  
 Osteotomes, Cartilage crusher  
 Osteótomos, Macha cadera  
 Osteotomi, Tritacartilagine

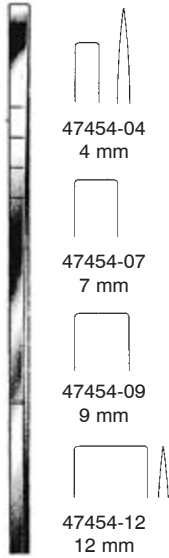

47454-04  
4 mm

47454-07  
7 mm

47454-09  
9 mm

47454-12  
12 mm

COTTLE  
47454-04 - 47454-12  
18 cm, 7"



6 mm

COTTLE  
47455-06  
18 cm, 7"

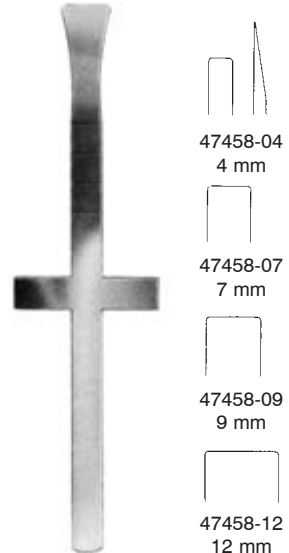

47458-04  
4 mm

47458-07  
7 mm

47458-09  
9 mm

47458-12  
12 mm

COTTLE  
47458-04 - 47458-12  
18 cm, 7"

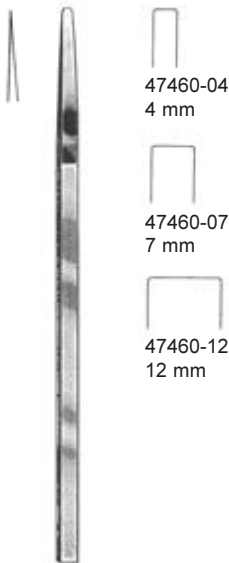

47460-04  
4 mm

47460-07  
7 mm

47460-12  
12 mm

COTTLE  
18 cm, 7"

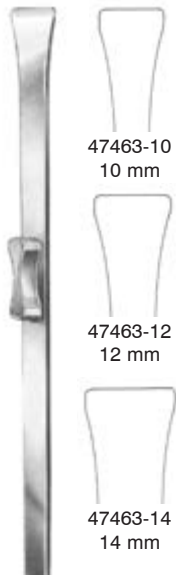

47463-10  
10 mm

47463-12  
12 mm

47463-14  
14 mm

RUBIN  
18,5 cm, 7 1/4"



COTTLE  
Knorpelquetscher  
47461-00

Osteotome, Septum Meißel  
 Osteotomes, Rhinoplastic Chisels  
 Osteótomos, Cinceles para la plàstica nasal  
 Osteotomi, Scalpelli per plastica nasale



FOMON  
 47470-04 - 47470-07  
 17 cm, 6 3/4"

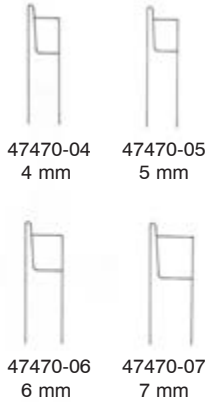

47470-04  
 4 mm

47470-05  
 5 mm

47470-06  
 6 mm

47470-07  
 7 mm



SHEEHAN  
 47471-07 - 47471-12  
 16 cm, 6 3/4"

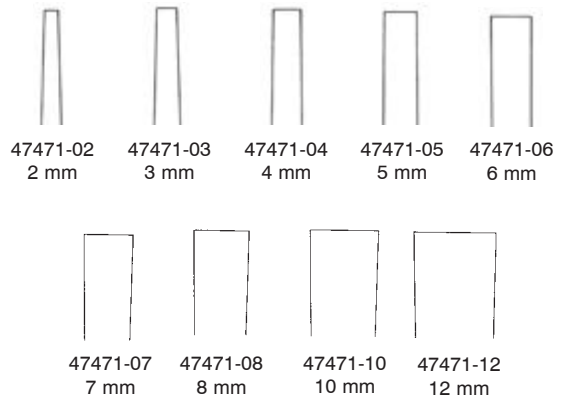

47471-02  
 2 mm

47471-03  
 3 mm

47471-04  
 4 mm

47471-05  
 5 mm

47471-06  
 6 mm

47471-07  
 7 mm

47471-08  
 8 mm

47471-10  
 10 mm

47471-12  
 12 mm



CINELLI  
 47472-10 - 47472-16  
 16 cm, 6 1/4"

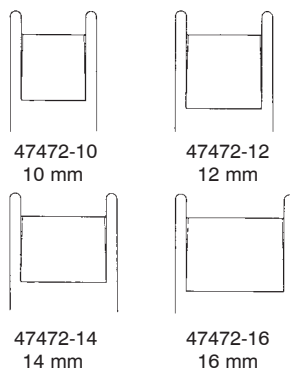

47472-10  
 10 mm

47472-12  
 12 mm

47472-14  
 14 mm

47472-16  
 16 mm

Septum Meißel, Osteotom  
 Rhinoplastic Chisels, Osteotom  
 Cinceles para la plástica nasal, Osteotóm  
 Scalpelli per plastica nasale, Osteotom

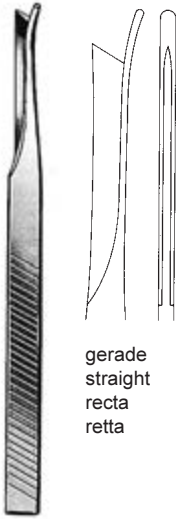

gerade  
 straight  
 recta  
 retta

SILVER  
 47473-01  
 18 cm, 7"

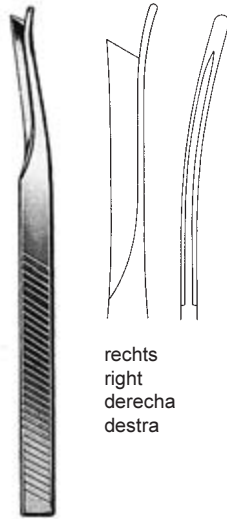

rechts  
 right  
 derecha  
 destra

SILVER  
 47473-02  
 18 cm, 7"

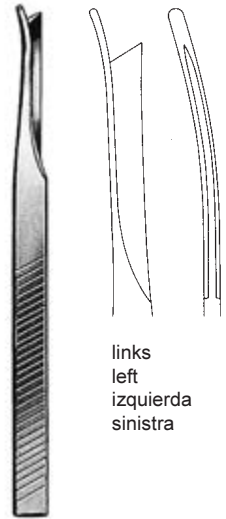

links  
 left  
 izquierda  
 sinistra

SILVER  
 47473-03  
 18 cm, 7"



47474-01

rechts  
 right  
 derecha  
 destra

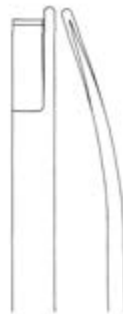

47474-02

links  
 left  
 izquierda  
 sinistra



47474-03

gerade  
 straight  
 recta  
 retta

NEIVERT-ANDERSON  
 47474-01 - 47474-03  
 20,5 cm, 8" 7 mm

Septum-Hohlmeißel, Osteotom  
 Septum Gouges, Osteotom  
 Gubias para tabique nasal, Osteótom  
 Sgorbie per il setto nasale, Osteotom



KILLIAN  
 47481-05  
 16 cm, 6 1/4"

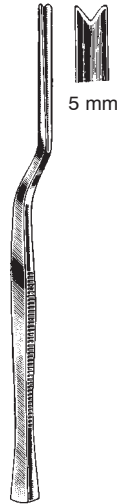

KILLIAN-CLAUS  
 47482-05  
 17 cm, 6 3/4"



mm	HAJEK
4	47484-04
6	47484-06
8	47484-08
	16 cm, 6 1/4"



WEST  
 47486-16  
 16 cm, 6 1/4"



WEST  
 47487-16  
 16 cm, 6 1/4"

6 mm



FREER  
 47489-16  
 16 cm, 6 1/4"



Knochenfeile, Nasenraspeln  
 Bone File, Nasal Rasps  
 Limas para hueso, Escofinas nasales  
 Lime per ossa, Raspa nasale



JOSEPH  
 47502-16  
 16 cm, 6 1/4"



MALTZ  
 47504-18  
 18 cm, 7"



WIENER  
 47507-17 - 47507-19  
 18 cm, 7"

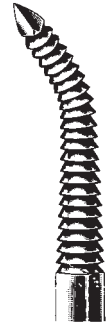

47507-17



47507-19

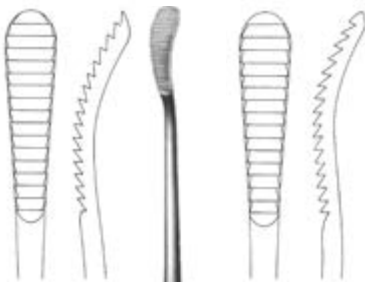

AUFRICHT  
 47511-21 21 cm, 8 1/4" 47513-21

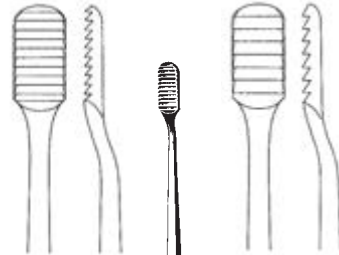

JOSEPH (LEWIS)  
 47514-16 18 cm, 7" 47516-16



Nasenraspeln  
 Nasal Rasps  
 Escofinas nasales  
 Raspa nasale

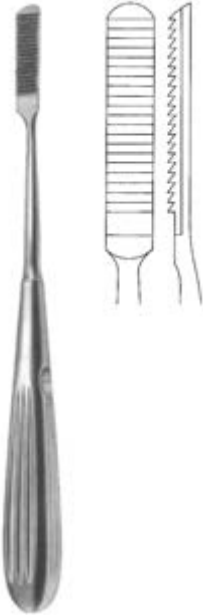

MALTZ (COTTLE)  
 47518-21  
 21 cm, 8 1/4"

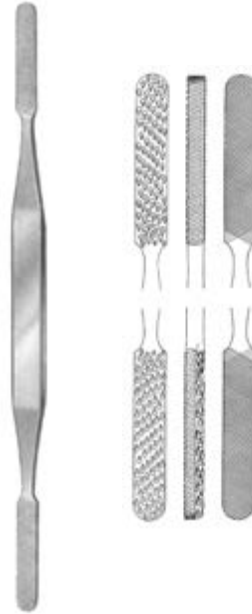

FOMON  
 47520-21  
 21 cm, 8 1/4"



MILLER  
 18 cm, 7"



47521-01

5 mm



47521-02

4,3 mm



47521-03

5 mm



Nasenraspeln  
Nasal Rasps  
Escofinas nasales  
Raspa nasale



FOMON

47522-01 - 47522-09 TC  
20 cm, 8"



Fig. 1/2

47522-01 TC



Fig. 3/4

47522-04 TC



Fig. 5/6

47522-05 TC



Fig. 7/8

47522-07 TC



Fig. 9/10

47522-09 TC

Nasenraspeln, Nasensägen  
 Nasal Rasps, Nasal Saws  
 Escofinas nasales, Sierras nasales  
 Raspa nasale, Seghe nasale



PEET  
 47523-01 —  
 47523-02 —  
 19 cm, 7 1/2"



GALLAHER  
 47526-16 - 47529-16  
 16 cm, 6 1/4"



Fig. 1  
 47526-16



Fig. 2  
 47527-16

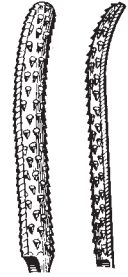

Fig. 3  
 47529-16



JOSEPH  
 47535-01 47535-02  
 17 cm, 6 3/4"



47533-19  
 gerade  
 straight  
 recta  
 retta



47532-19  
 links  
 left  
 izquierda  
 sinistra



47534-19  
 rechts  
 right  
 derecha  
 destra

JOSEPH  
 19 cm, 7 1/2"

Nasenhaken  
Nasal retractor  
Retradores nasales  
Retrattori nasali



COTTLE  
47540-16  
16 cm, 6 1/4"



MASING  
47541-14  
14 cm, 5 1/2"



AUFRICT  
47542-12  
12 cm, 4 3/4"



AUFRICT  
47551-16  
16 cm, 6 1/4"



AUFRICT  
47551-16L  
16 cm, 6 1/4"



MASING-NEIVERT  
47552-16  
16 cm, 6 1/4"

Nasenhaken, Hauthäkchen  
 Nasal retractor  
 Retractores nasales, Ganchos para la piel  
 Retrattori nasali, uncini nasali

10 x 12 mm



COTTLE  
 47553-15  
 15 cm, 6"



47554-01

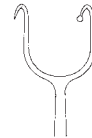

47554-02



47554-03

COTTLE  
 14,5 cm, 5 3/4"

3 x 11 mm



KILNER  
 47555-08  
 8 cm, 3 1/8"

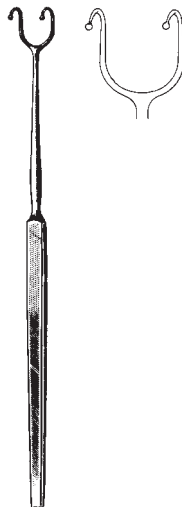

FOMON  
 47556-16  
 16 cm, 6 1/4"



FOMON  
 47557-17  
 17 cm, 6 3/4"



Hauthäkchen, Columella Pinzette  
 Retractor, Columnella forceps  
 Ganchos para la piel, Pinza para columella  
 Uncini, Pinzetta columella



FREER  
 47558-15  
 15 cm, 6"



COTTLE-NEIVERT  
 47559-20  
 20 cm, 8"



GILLIES  
 18 cm, 7"



Fig. 1  
 47560-18



Fig. 2  
 47562-18



LANGE  
 47563-22  
 23 cm, 9"



COTTLE  
 47564-16  
 16 cm, 6 1/4"



COTTLE  
 47565-10  
 10 cm, 4"



CONVERSE  
 47566-12  
 12 cm, 4 3/4"

Septumrichtzangen, Küretten  
 Septum Straightening Forceps, Curettes  
 Pinza para enderezar el tabique nasal, curetas  
 Pinza per la plastica nasale, Curette



ASCH  
 47571-23  
 23 cm, 9"



WALSHAM  
 47572-23 - 47575-23  
 23 cm, 9"



47572-23  
 gerade  
 straight  
 recta  
 retta

47573-23  
 links  
 left  
 izquierda  
 a sinistra

47575-23  
 rechts  
 right  
 derecha  
 a destra

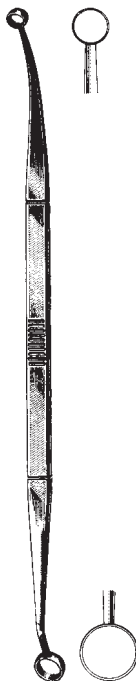

FAULKNER  
 47601-21  
 21 cm, 8 1/4"



COAKLEY  
 47607-01 - 47607-06  
 17 cm, 6 3/4"



47607-01  
 Fig. 1



47607-02  
 Fig. 2



47607-03  
 Fig. 3



47607-04  
 Fig. 4



47607-05  
 Fig. 5



47607-06  
 Fig. 6

Ringmesser  
Adenoid Currettes  
Cuchillos para vegetaciones adenoides  
Coltelli per vegetazioni adenoide

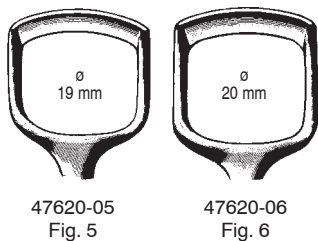
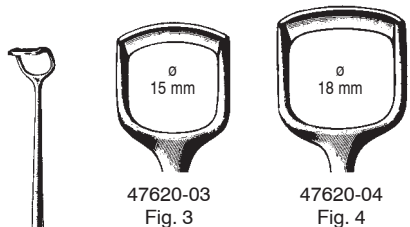
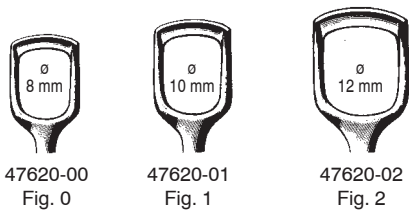

BECKMANN  
47620-01 - 47620-06  
22 cm, 8 3/4"

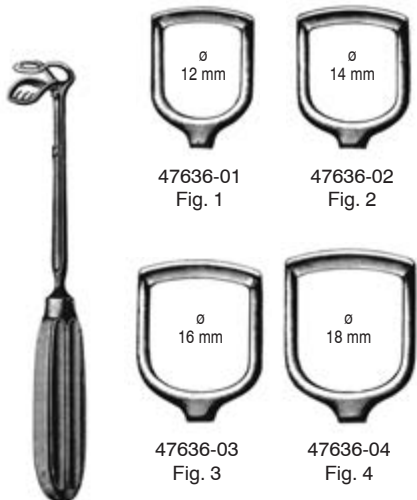

St. CLAIR-THOMSON  
47636-01 - 47636-04  
21 cm, 8 1/4"

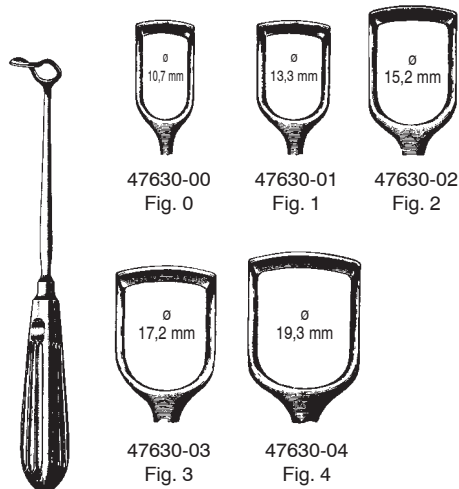

BARNHILL  
47630-01 - 47630-04  
21 cm, 8 1/4"

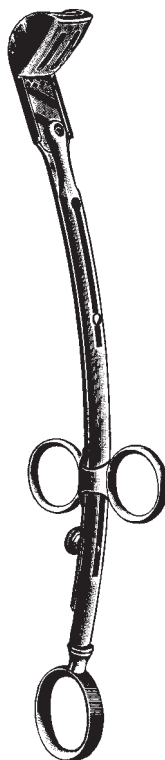

LAFORCE  
47641-01 - 47641-03  
25 cm, 10"

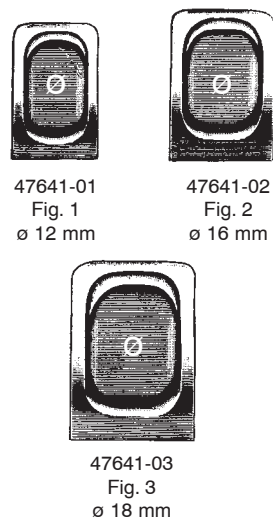

Ersatzklingen allein, gelocht  
Spare blades, perforated  
Hojas de repuesto, perforadas  
Lame di ricambio, forate

Fig. 1 47642-01  
Fig. 2 47642-02  
Fig. 3 47642-03



Zungenspatel, Wangen- und Lippenhalter  
 Tongue Depressors, Cheek and Lip Retractors  
 Baja-lenguas, Separadores para labios y mejillas  
 Abbassalingua, Divaricatori per guance e labbra

Holz  
 wood  
 madera  
 legno



49102-16  
 16 cm, 6 1/4"  
 Pack. à 100

21,7 mm



MAYO  
 49103-17  
 17 cm, 6 3/4"

21,4 mm



KROENIG  
 49104-15  
 15 cm, 6"

23 mm



FRENZEL  
 49105-16  
 16,5 cm, 6 1/2"

13 mm

16 mm



49106-01  
 14,5 cm, 5 3/4"

15 mm



49106-02  
 14,5 cm, 5 3/4"

15 mm



BRUENINGS  
 49107-19  
 19 cm, 7 1/2"

19 mm

20 mm



CAWOOD-MINNESOTA  
 49108-15  
 15 cm, 6"

20 mm

23 mm



BUCHWALD  
 49109-19  
 19 cm, 7 1/2"

19 mm

Zungendrucker  
Tongue Depressors  
Baja-lenguas  
Abassalingua



MORITZ-SCHMIDT  
49110-19  
19 cm, 7 1/2"



HARTMANN  
49111-15  
15 cm, 6"



49115-01  
Fig. 1  
14 cm, 5 1/2"



49115-02  
Fig. 2  
15 cm, 6"

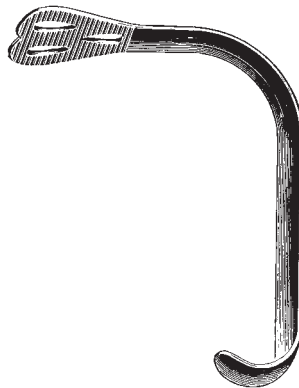

WIEDER  
49115-01 - 49115-02



ANDREW  
49117-11  
11 cm, 4 3/8"

Zungendrucker, Wangen- und Lippenhalter, Zungenzangen  
 Tongue Depressor, Cheek and Lip Retractor, Tongue Holding Forceps  
 Baja-lenguas, Separadores para labios y mejillas, Pinza tira-lenguas  
 Abassalingua, Divaricatori per guance e labbra, Pinza tiralingua

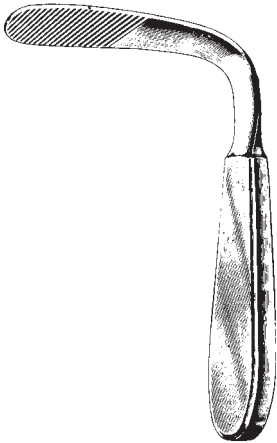

TOBOLD  
 49119-14  
 14,5 cm, 5 3/4"

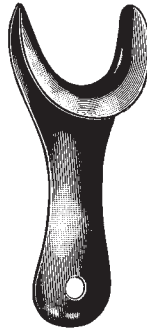

49230-11  
 11 cm, 4 3/8"



26 mm  
 37 mm  
 STERNBERG  
 49231-12 12 cm, 4 3/4"  
 49231-14 14 cm, 5 1/2"  
 49231-16 16 cm, 6 1/4"



49235-19  
 19 cm, 7 1/2"

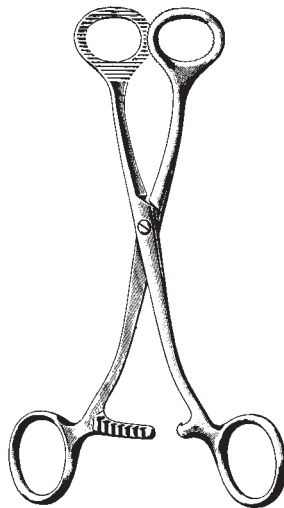

COLLIN  
 49250-16 16 cm, 6 1/4"  
 49250-18 18 cm, 7"

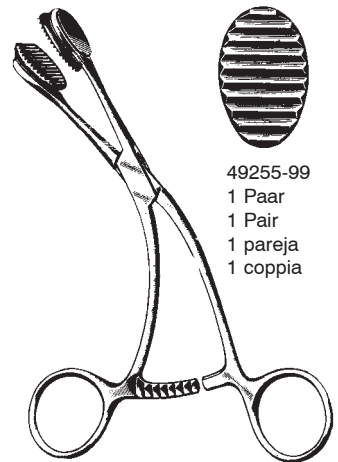

49255-99  
 1 Paar  
 1 Pair  
 1 pareja  
 1 coppia  
 YOUNG  
 49255-16  
 16 cm, 6 1/4"

Mundsperrer  
Mouth Gags  
Abre-Bocas  
Apribocca

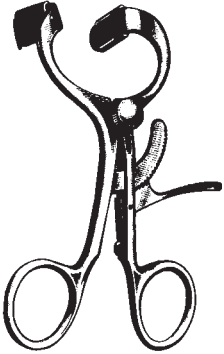

DOYEN-JANSEN (MOLT)  
49265-12  
12 cm, 4  $\frac{3}{4}$ "

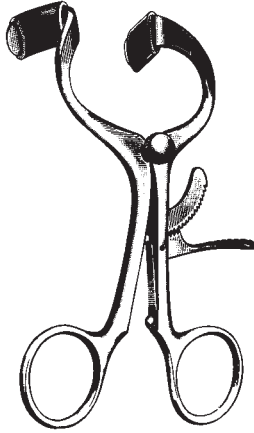

DOYEN-JANSEN (MOLT)  
49265-14  
14 cm, 5  $\frac{1}{2}$ "

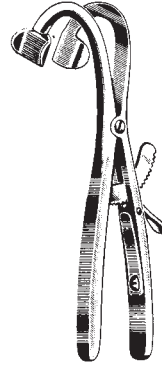

DENHART  
49267-12  
12 cm, 4  $\frac{3}{4}$ "

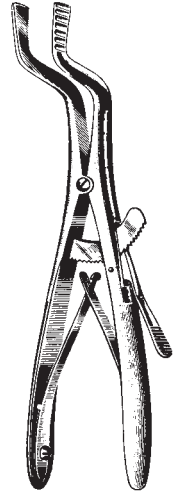

ROSER-KOENIG  
49270-16 16 cm, 6  $\frac{1}{4}$ "  
49270-19 19 cm, 7  $\frac{1}{2}$ "

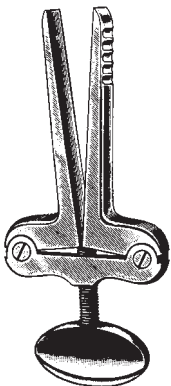

HEISTER  
49272-13  
13 cm, 5  $\frac{1}{8}$ "

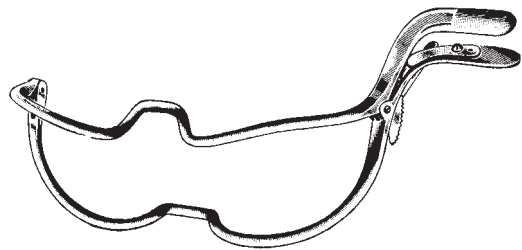

JENNINGS  
49274-09 9 cm, 3  $\frac{1}{2}$ "  
49274-11 11 cm, 4  $\frac{3}{8}$ "  
49274-13 13 cm, 5  $\frac{1}{8}$ "  
49274-15 15 cm, 6"

Zungenspatel, Mundsperrer  
 Tongue depressor, Mouth Gags  
 Baja-lengua, Abrebocas  
 Abbassalingua, Apribocca



linke Seite  
 left side  
 izquierda  
 lato sinistro

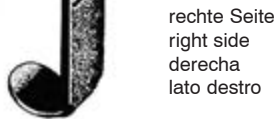

rechte Seite  
 right side  
 derecha  
 lato destro

RING

- |          |        |          |
|----------|--------|----------|
| 49287-02 | Fig. 2 | 49288-02 |
| 49287-03 | Fig. 3 | 49288-03 |
| 49287-04 | Fig. 4 | 49288-04 |
| 49287-05 | Fig. 5 | 49288-05 |

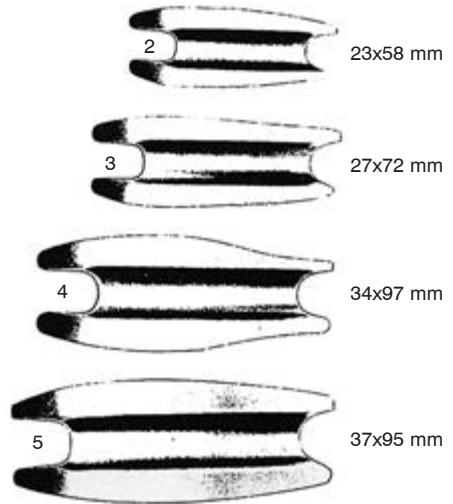

2 23x58 mm

3 27x72 mm

4 34x97 mm

5 37x95 mm

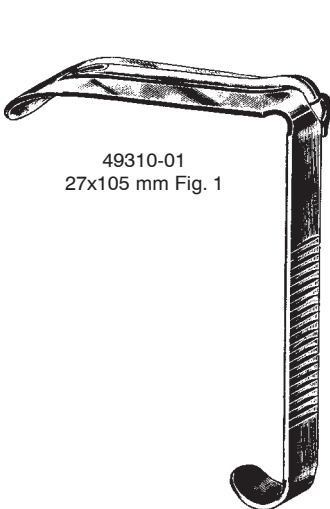

49310-01  
 27x105 mm Fig. 1

DAVIS-BOYLE  
 49310-00  
 compl.



49310-02  
 25x90 mm Fig. 2



49310-03  
 25x75 mm Fig. 3



49310-04  
 22x60 mm Fig. 4



49310-05  
 20x25 mm Fig. 5

49310-08 Silikoneinlagen/Silicone pads  
 inserto de silicona/inserto in silicone

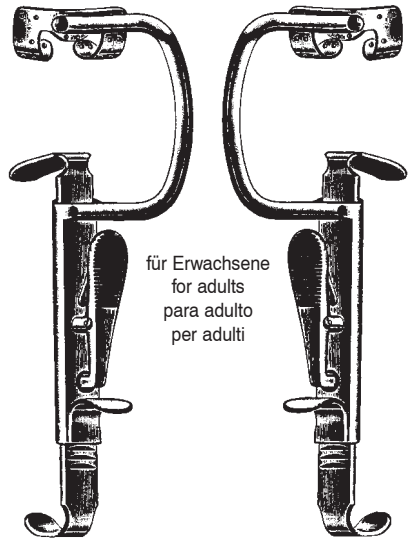

für Erwachsene  
 for adults  
 para adulto  
 per adulti

49310-10  
 Sperrer allein, links  
 Gag only, left  
 Abre-boca suelta, izquierda  
 Apribocca solo, sinistra

49310-12  
 Sperrer allein, rechts  
 Gag only, right  
 Abre-boca suelta, derecha  
 Apribocca solo, destra

Mundsperrer  
Mouth Gags  
Abre-Bocas  
Apribocca

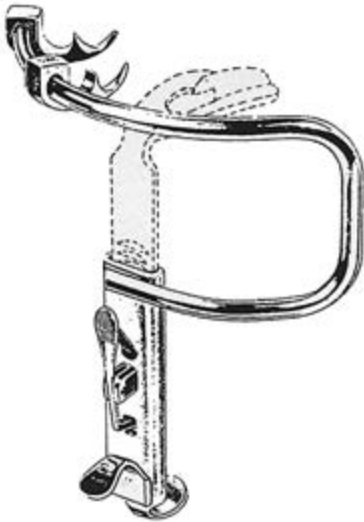

49315-10  
Sperrer allein  
Gag only  
Abre-boca solo  
Apribocca solo



49315-01  
37 x 80 mm  
Fig. 1



49315-02  
32 x 75 mm  
Fig. 2



49315-03  
28 x 65 mm  
Fig. 3

#### KILNER-DOUGHTY

49315-00  
komplett  
complete  
completo

**49317-00 DINGMANN, complete**  
mit 3 auswechselbaren Zungendrücke,  
2 seitliche Wangenhaken und 2 Zahnhaken

with 3 interchangeable tongue depressors,  
2 rotating cheek holders  
2 movable tooth hooks and thread guide

con 3 baja lenguas intercambiables,  
2 valvas giratorias p. los labios,  
2 ganchos graduables

con 3 depressori intercambiabili,  
2 valve laterali rotative  
2 uncini a denti movibile



DINGMANN  
49317-10  
Sperrer allein, Gag only  
Abre-boca solo, Apribocca solo



1 24x62 mm  
49317-01



2 28x65 mm  
49317-02



3 31x75 mm  
49317-03

Mundsperrer  
Mouth Gag  
Abre-bocas  
Apribocca

49320-20  
Silikon-Schlauch  
Silicon Tubing  
tubo de silicona  
tubo in silicone

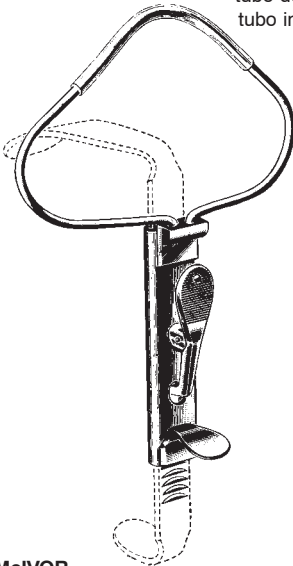

**McIVOR**  
49320-00  
compl.

49320-10

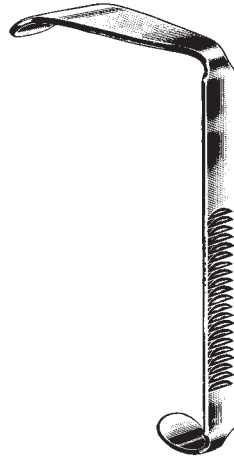

49320-01  
27x95 mm Fig. 1



49320-02  
22x85 mm Fig. 2



49320-03  
22x70 mm Fig. 3



**DAVIS-MEYER**  
49340-00

Zungenspatel  
Tongue blades  
Baja-lenguas  
Abbassalingua

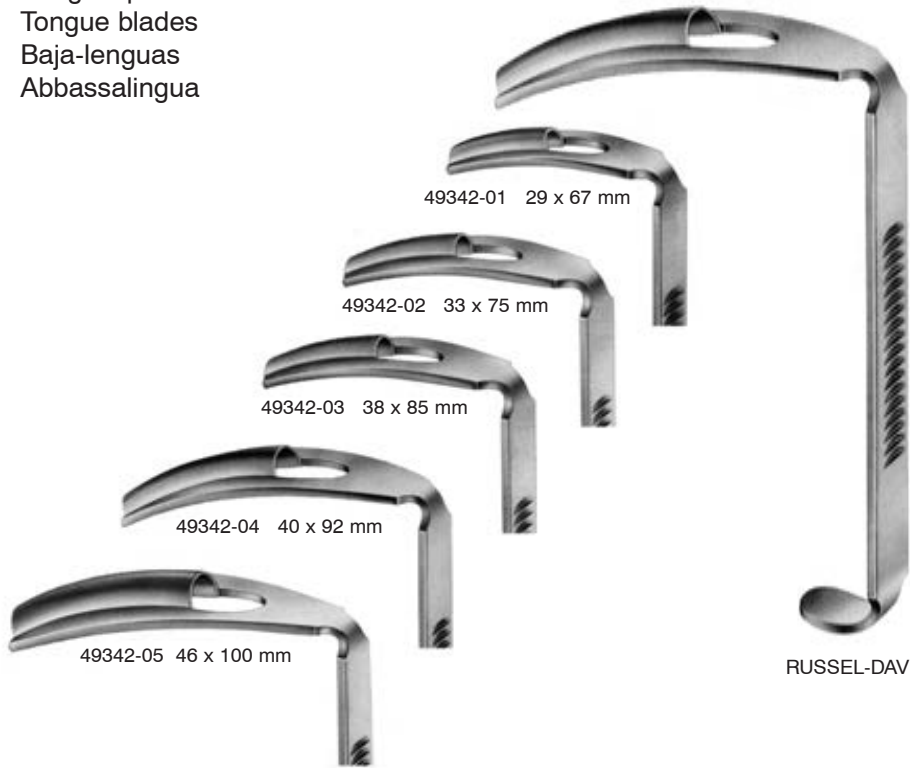

RUSSEL-DAVIS

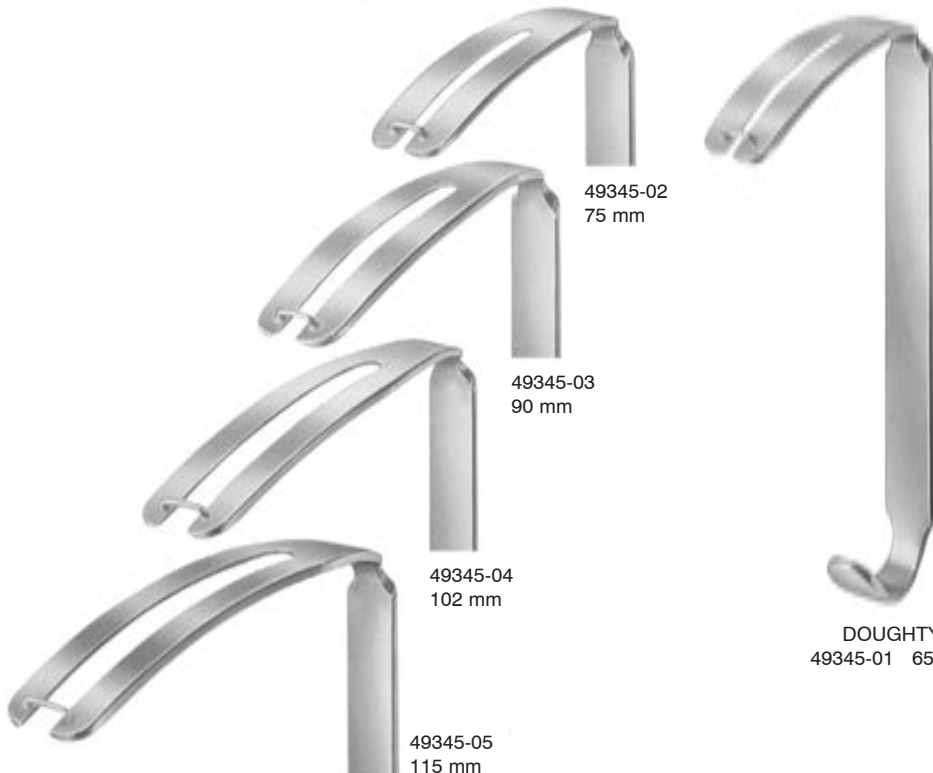
DOUGHTY  
49345-01 65 mm



Mundkeil, Bruststütze, Repositionszange  
 Oral wedges, Chest support, Disimpaction forceps  
 Abreboca, Soporte de pecho, Pinzas para reposiciones  
 Apribocca, Supporto per petto, Pinze per riposizione

Holz  
 wood  
 madera  
 legno



MAUNDER  
 49360-10



NEGUS  
 49400-01



links  
 left side  
 izquierda  
 lato sinistro

ROWE

- 49501-22 22,5 cm, 8.9"
- 49501-23 23,5 cm, 9 1/4"
- 49501-24 24,0 cm, 9 1/2"

- Baby, baby, bebé, lattante
- Kind, child, niño, bambino
- Erwachs., adult, adulto



rechts  
 right side  
 derecha  
 lato destro

ROWE

- 49503-22 22,5 cm, 8.9"
- 49503-23 23,5 cm, 9 1/4"
- 49503-24 24,0 cm, 9 1/2"

Wundhaken für Mund-Kiefer-Gesicht  
 Retractors for Mouth-, Jaw- and Face Surgery  
 Separadores para cirugía plástica  
 Divaricatori per chirurgia plastica

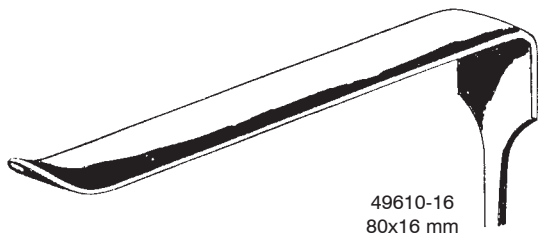
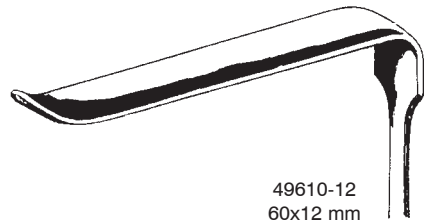
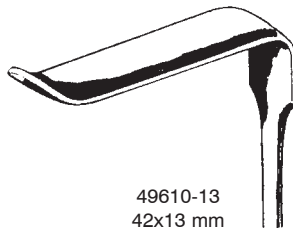
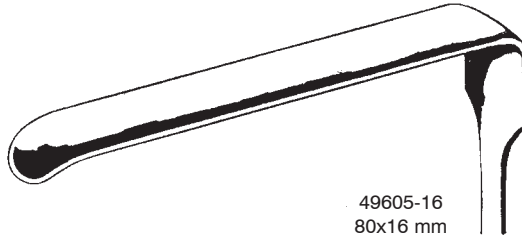
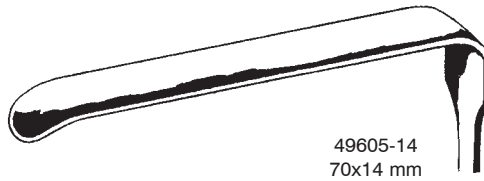
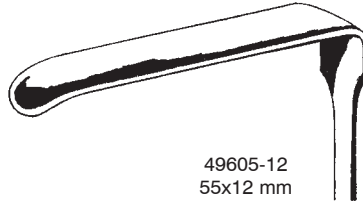
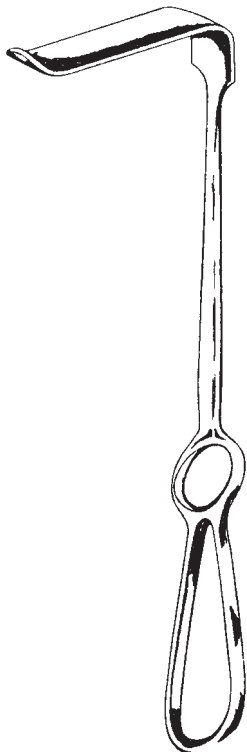
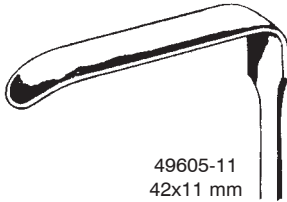
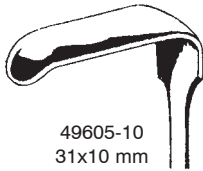

Wundhaken für Mund-Kiefer-Gesicht  
Retractors for Mouth-, Jaw- and Face Surgery  
Separadores para cirugía plástica  
Divaricatori per chirurgia plastica

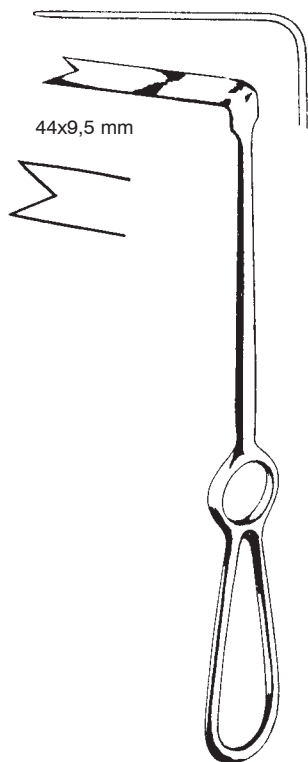

SPINA-NASALIS  
49613-10  
22 cm, 8 3/4"

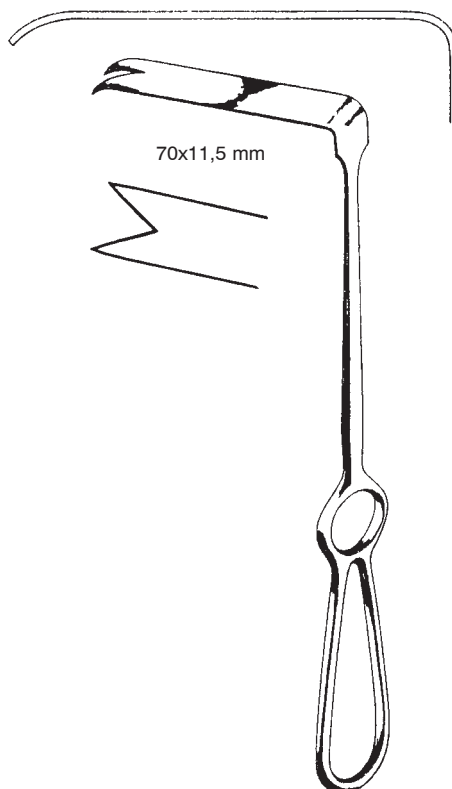

RAMUS  
49615-12  
22 cm, 8 3/4"

Wundhaken für Mund-Kiefer-Gesicht, Raspatorien  
 Retractors for Mouth-, Jaw- and Face Surgery, Periosteal Elevators  
 Separadores para cirugía plástica, Periostótomos  
 Divaricatori per chirurgia plastica, Periostotomi

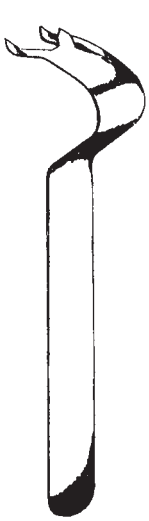

OBWEGESER  
 49620-15  
 15,5 cm, 6"

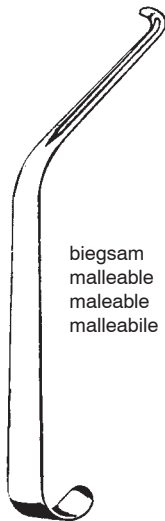

OBWEGESER  
 49623-16  
 16 cm, 6 1/4"

biegsam  
 malleable  
 maleable  
 malleabile



OBWEGESER  
 49627-01  
 21 cm, 8 1/4"

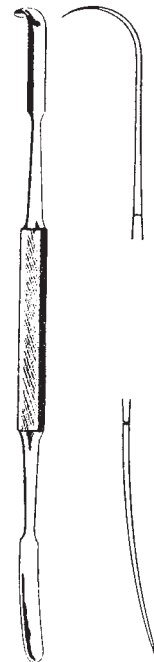

OBWEGESER  
 49630-02  
 20,5 cm, 8"

Drahtbogen  
Wire Pushers  
Empujadores de alambres  
Posizionatori per filo

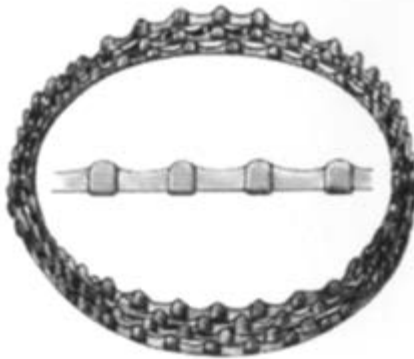

ERICH  
49631-00  
20,5 cm, 8"

Raspatorien  
 Periosteal Elevators  
 Periostótomos  
 Periostotomi

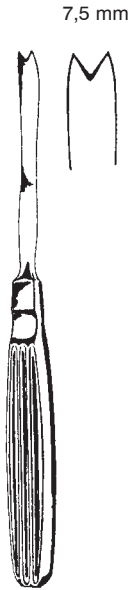

OBWEGESER  
 49635-18  
 17,5 cm, 7"



OBWEGESER  
 49640-05 - 49640-09  
 20 cm, 8"

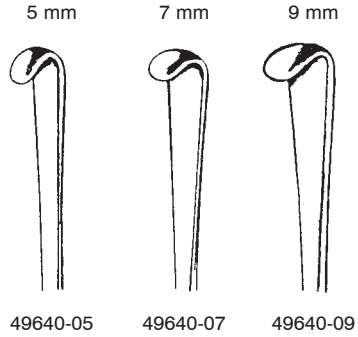

49640-05      49640-07      49640-09



OBWEGESER  
 49650-06 - 49650-11  
 17,5 cm, 7"



49650-06



49650-07



49650-09



49650-11

Elevator, Osteotom, Ahle  
 Elevator, Osteotome, Awls  
 Elevadores, Osteotomos, Agujas  
 Elevatori, Osteotomo, Aghi



DINGMAN  
 49660-18  
 18 cm, 7"



OBWEGESER  
 49665-24  
 23,5 cm, 9 1/4"



Vorderrandstripper  
 Anterior Border Stripper  
 Separador para el borde anterior  
 Separatore per il bordo anteriore

HARGIS  
 49670-19  
 19 cm, 7 1/2"



Spreizzange  
 Ramus Separator  
 Pinza para separar la rama  
 Pinza per separare il ramo

SMITH  
 49670-20  
 23,5 cm, 9 1/4"

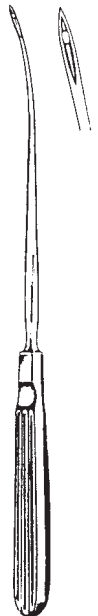

OBWEGESER  
 49670-23  
 23 cm, 9"

Intraorale Retraktoren  
 Intra Oral Retractors  
 Separadores intra orales  
 Retrattori intraorali

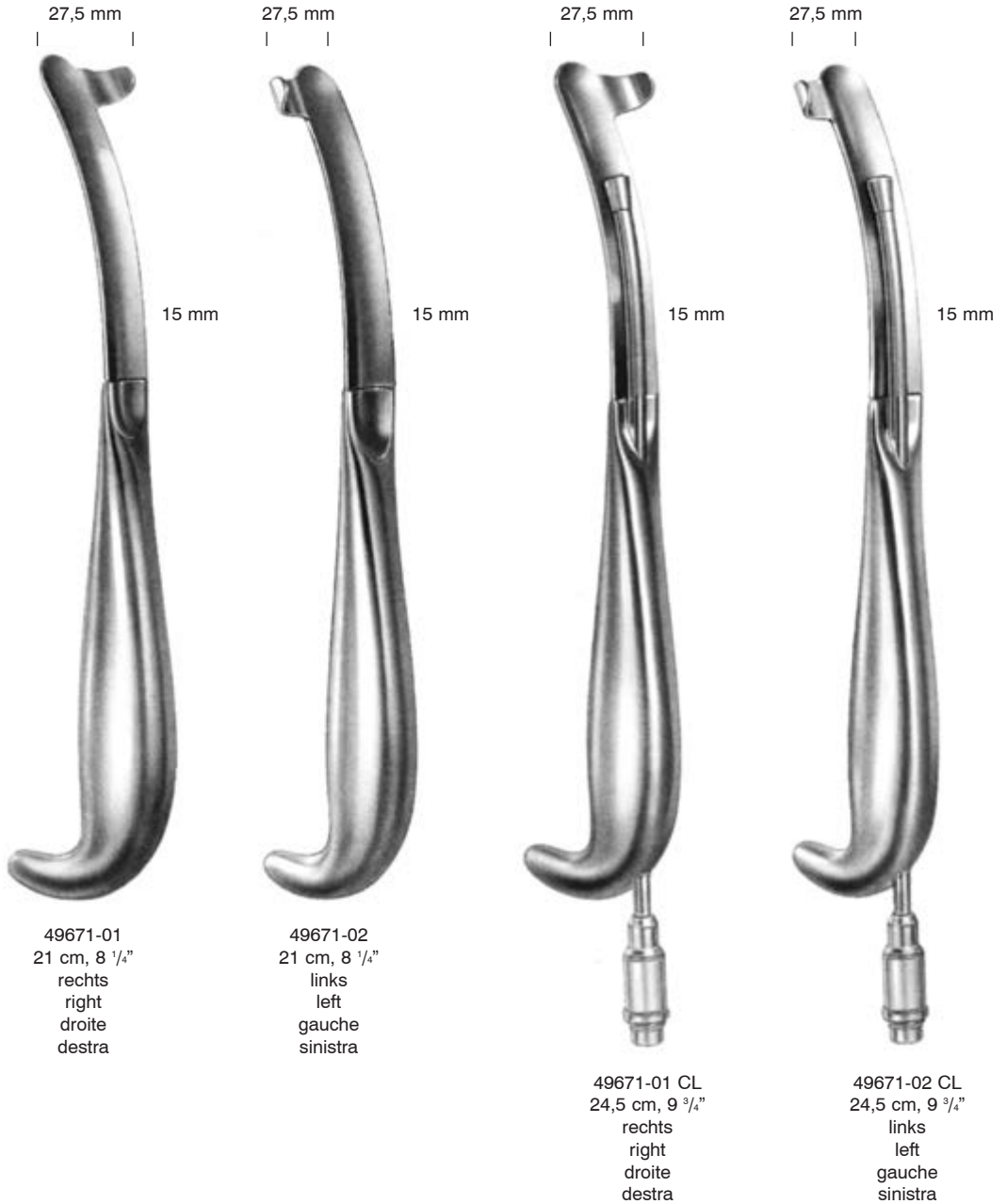



Raspatorien  
Periosteal Elevators  
Legras  
Elevatori per periostio



HARGIS  
23 cm, 9"



49673-01  
6,5 mm  
rechts  
right  
derecha  
destra



49673-02  
9 mm  
rechts  
right  
derecha  
destra



49673-03  
6,5 mm  
links  
left  
izquierda  
sinistra



49673-04  
9 mm  
links  
left  
izquierda  
sinistra

Ahle, Haken, Elevator  
 Awls, Retractors for Mouth-, Jaw- and Face Surgery  
 Aguja, Separadores para cirugía plástica  
 Aghi, Divaricatori per chirurgia plastica



OBWEGESER  
 49675-18  
 18 cm, 7"



19 cm, 7 1/2"

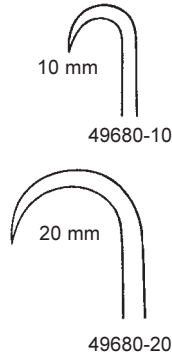

10 mm

49680-10

20 mm

49680-20



DINGMAN  
 49685-21  
 21 cm, 8 1/4"

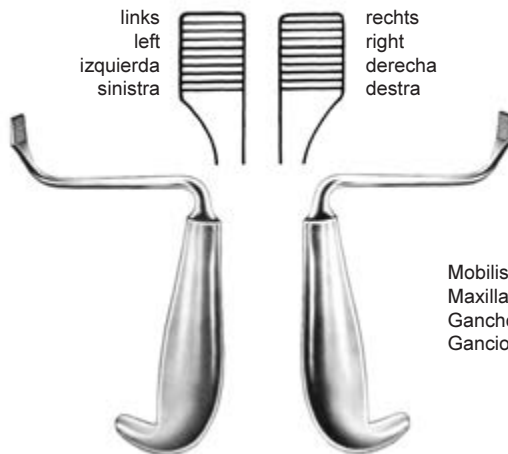

links  
 left  
 izquierda  
 sinistra

rechts  
 right  
 derecha  
 destra

Mobilisierhaken  
 Maxillary Mobilizer  
 Gancho para movilización  
 Gancio per mobilizzare

TESSIER  
 49691-15 15 cm, 6"

TESSIER  
 49692-15 15 cm, 6"

Intraorale Retraktoren  
Intra Oral Retractors  
Separadores intra orales  
Retrattori intraorali



49694-25  
25 cm, 9 <sup>3</sup>/<sub>4</sub>"  
12,5 / 27 mm

49694-25 CL  
28 cm, 11"  
12,5 / 27 mm

Sagittalspreizer  
Sagittal Split Separators  
Separadores sagitales  
Separatori sagittali



rechts  
right  
derecha  
destra



SMITH  
49695-01  
18,5 cm, 7 1/4"  
9 mm

links  
left  
izquierda  
sinistra



SMITH  
49695-02  
18,5 cm, 7 1/4"  
9 mm

Unterkieferkörperhaken  
Mandibular Body Retractor  
Separador para el cuerpo mandibular  
Separatore per il corpo mandibolare

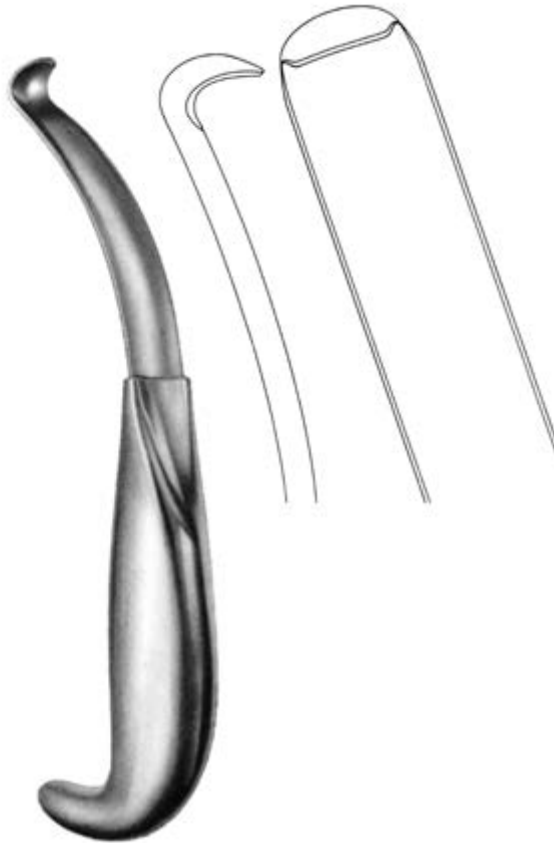

HARGIS  
49696-18  
18 cm, 7"

Osteotome  
Osteotome  
Osteótomos  
Osteotomi



49700-01  
21,5 cm, 8 1/2"



49700-02  
21,5 cm, 8 1/2"

Blattosteotom  
Blade Osteotomes  
Osteótomos de hoja  
Osteotomo a lama



OBWEGESER  
22 cm, 8 3/4"



49705-08  
8 mm



49705-12  
12 mm



49705-16  
16 mm



49705-20  
20 mm

Osteotome  
 Osteotome  
 Osteótomos  
 Osteotomi

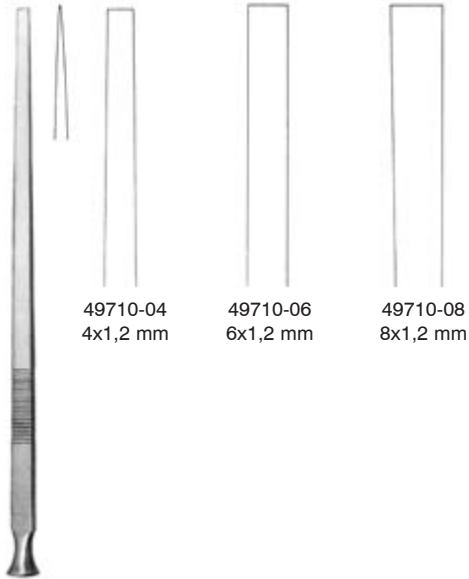

49710-04  
 4x1,2 mm

49710-06  
 6x1,2 mm

49710-08  
 8x1,2 mm

EPKER  
 18 cm, 7"

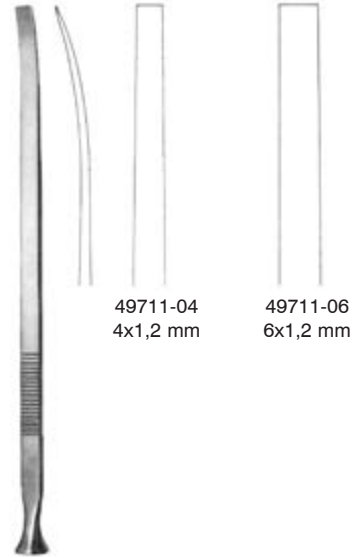

49711-04  
 4x1,2 mm

49711-06  
 6x1,2 mm

EPKER  
 18 cm, 7"

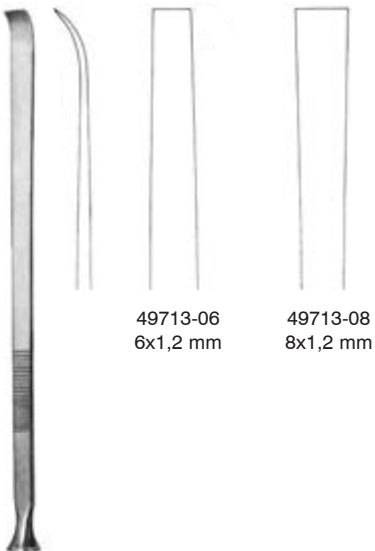

49713-06  
 6x1,2 mm

49713-08  
 8x1,2 mm

EPKER  
 18 cm, 7"



Wundhaken, Tonsillen-Elevatoren, Tamponstopfer  
 Retractors, Tonsil-Elevators, Gauze packer  
 Separadores, Elevadores para amígdalas, Tamponeador  
 Divaricatori, Elevatori, Tamponatore

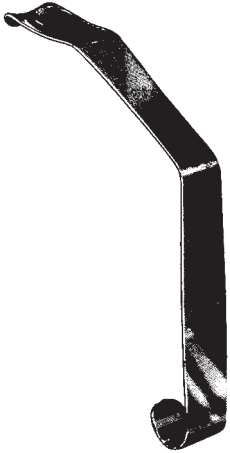

LOVE 15 cm, 6"  
 51103-18 18 mm  
 51103-20 20 mm  
 51103-22 22 mm



HOFER  
 51109-24  
 24 cm, 9 1/2"



NAGER  
 51111-23  
 23 cm, 9"



HURD  
 51131-22  
 22 cm, 8 1/4"



LOPEZ-REINKE  
 51133-23  
 23 cm, 9"



YANKAUER  
 51134-21  
 21 cm, 8 1/4"



51135-01



51135-02



HENKE  
 23 cm, 9"



CARPENTER  
 51139-25  
 25 cm, 10"



CARPENTER  
 51143-24  
 24 cm, 9 1/2"



LUNIATSCHEK  
 51151-19  
 19 cm, 7 1/2"

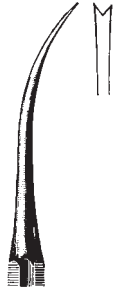

Tonsillen-Nadeln, Tonsillen-Messer

Tonsil Needles, Tonsil-Knives

Agujas para suturas de amígdalas, Bisturios para amígdalas

Aghi per tonsille, Coltelli per tonsille

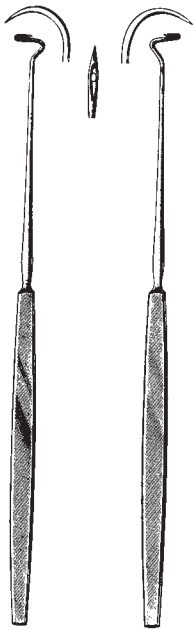

DUPUY-WEISS  
51165-22 51167-22  
22 cm, 8 3/4"



CLAUS  
51168-23  
23 cm, 9"



CLAUS-EICKEN  
51169-23  
23 cm, 9"



NAGER  
51170-24  
24 cm, 9 1/2"



FISHER  
51171-22  
22,5 , 9"



ABRAHAM  
51172-19  
19 cm, 7 1/2"



ABRAHAM  
51173-21  
21 cm, 8 1/4"



CANFIELD  
51174-21  
21 cm, 8 1/4"



BRUENINGS  
51177-23  
23 cm, 9"



DOUGLAS  
51178-21  
21 cm, 8 1/4"



DOUGLAS  
51179-17  
17 cm, 6 3/4"

Tonsillenzange  
 Tonsil Seizing Forceps  
 Pinzas para coger las amígdalas  
 Pinze per tonsille

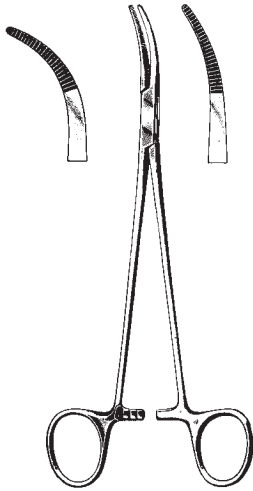

19 cm, 7 1/2"  
 SAWTELL    SCHNIDT  
 51181-19    51183-19

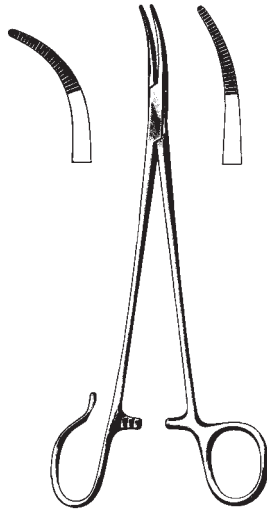

19 cm, 7 1/2"  
 SAWTELL    SCHNIDT  
 51185-19    51187-19

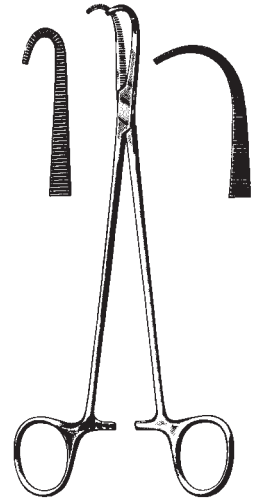

19 cm, 7 1/2"  
 NEGUS    NEGUS  
 51191-19    51193-19

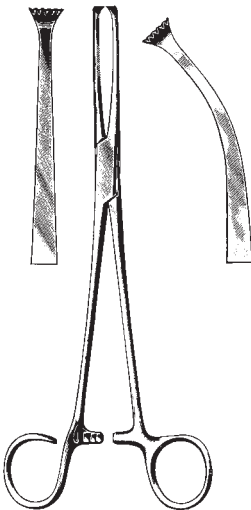

19 cm, 7 1/2"  
 COLVER  
 51202-19    51203-19

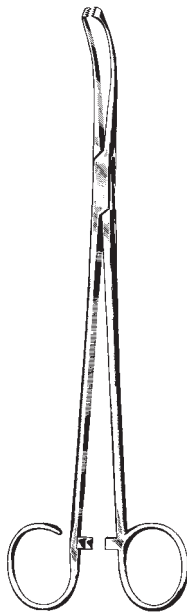

WHITE  
 51205-18    18 cm, 7"  
 51205-23    23 cm, 9"

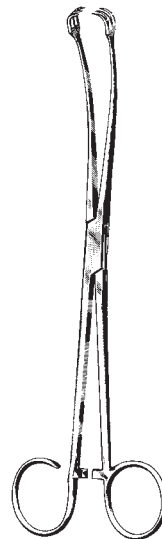

BALLENGER  
 51207-21  
 21,5 cm, 8 1/2"

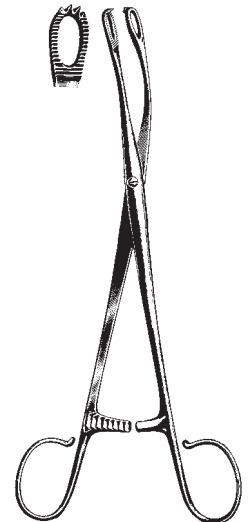

BLOHMKE  
 51209-20  
 20 cm, 8"

Tonsillen-Zangen u. -Pinzetten, Tonsillen-Kompressoren, Tonsillen-Schnürer  
 Tonsil-Forceps, Tonsil-Snares  
 Pinzas, Compresores para amígdalas, Cierra-nudos para amígdalas  
 Pinze, Compressori per tonsille, Serranodi per tonsille



ABRAHAM  
 51210-20  
 20 cm, 8"

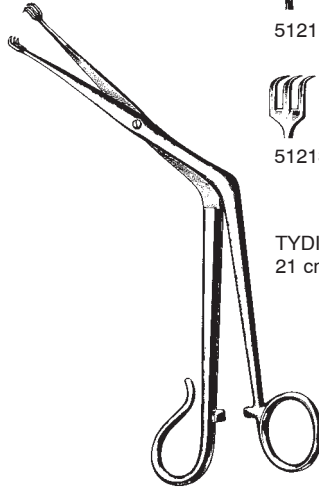

51211-21



51213-21

TYDING  
 21 cm, 8 1/4"

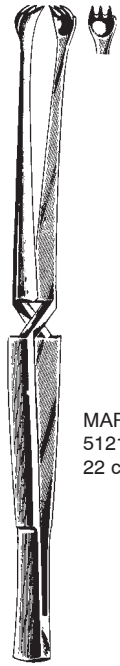

MARSCHIK  
 51219-22  
 22 cm, 8 3/4"



EVES  
 51250-28  
 28 cm, 11"



EVES  
 51252-28  
 28 cm, 11"



BRUENINGS  
 51256-28  
 28 cm, 11"

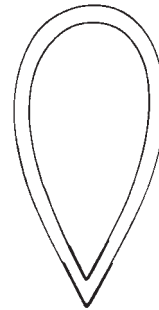

51257-40 40 mm  
 51257-50 50 mm  
 Pack of 100 pcs



51259-03 0,3 mm  
 51259-04 0,4 mm  
 51259-05 0,5 mm  
 Pack of 12 pcs

Tonsillotom  
Tonsillectomes  
Amigdalótomos  
Tonsillotomi

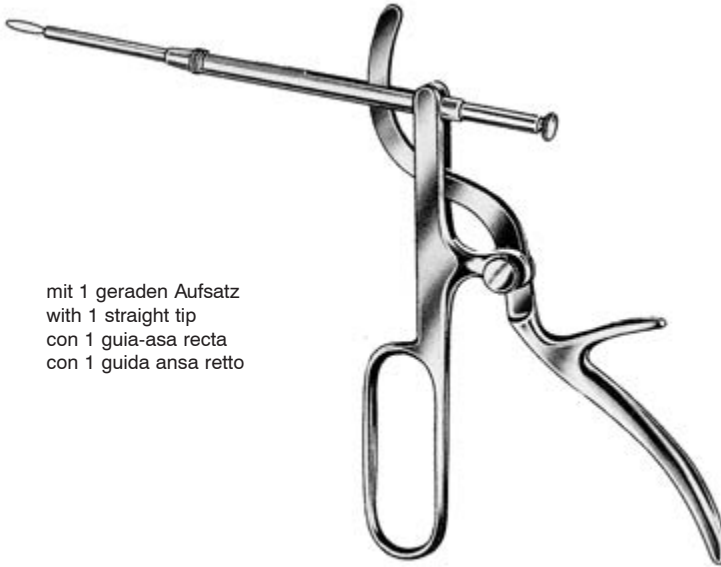

mit 1 geraden Aufsatz  
with 1 straight tip  
con 1 guida-asa recta  
con 1 guida ansa retto

TYDING  
51260-00

Tonsillotom, Spritzen, Septum Nadeln  
 Tonsillectomes, Syringes, Septum needles  
 Amigdalótomos, Jeringas, Septum aguja  
 Tonsillotomi, Siringhe, Septum aghi

Aufsatz allein  
 blade only  
 hoja sola  
 lama sola

51270-01

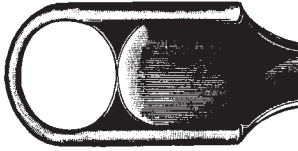

1

51270-02

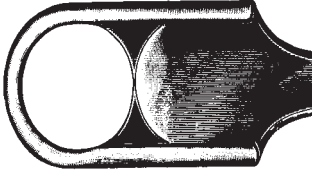

2

51270-03

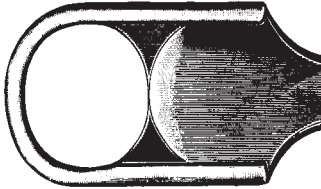

3

51270-04  
 Handgriff allein  
 Handle only  
 mango para  
 manipolo solo

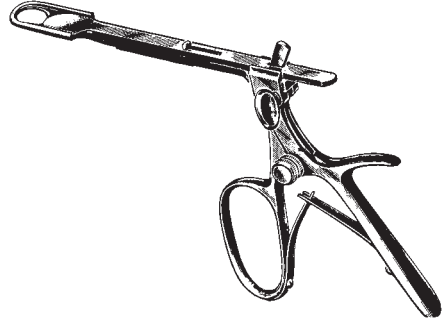

SLUDER-BALLENGER  
 51270-00  
 mit 3 Aufsätzen  
 with 3 blades  
 con 3 hojas  
 con 3 lame

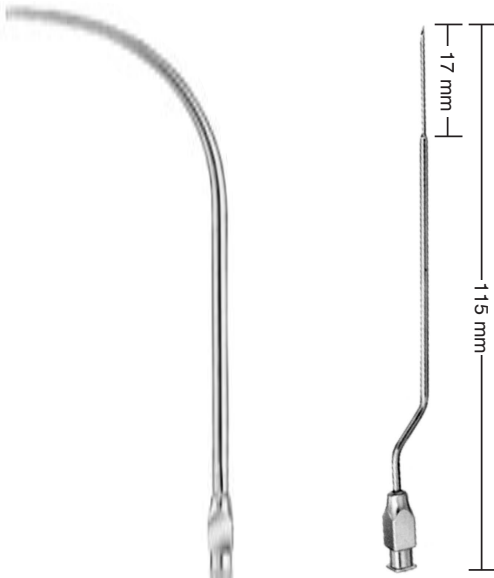

51291-00  
 2,5 mm Ø

51293-00  
 0,8 mm Ø

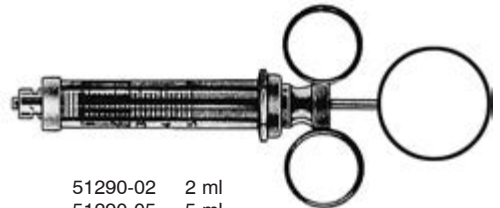

51290-02 2 ml  
 51290-05 5 ml  
 51290-10 10 ml  
 51290-20 20 ml



51292-00



51293-45  
 45°



51293-90  
 90°

Septum-Schere, Kehlkopfpolypenzangen, Deckelhalter  
 Septum-Scissors, Laryngeal Polypus Forceps, Epiglottis Retractor  
 Tijeras para septo, Pinzas para pólipos laríngeos, Depresor para epiglottis  
 Forbice per il setto nasale, Pinze per polipi laringei, Depressore per epiglottide



KILLIAN  
 53102-20  
 20 cm, 8"



53101-22



53103-22



JACKSON  
 53101-22 - 53103-22  
 22 cm, 8 3/4"

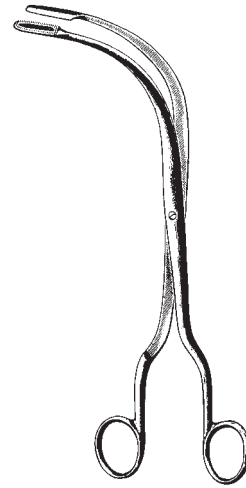

FRAENKEL  
 53111-18  
 18 cm, 7"

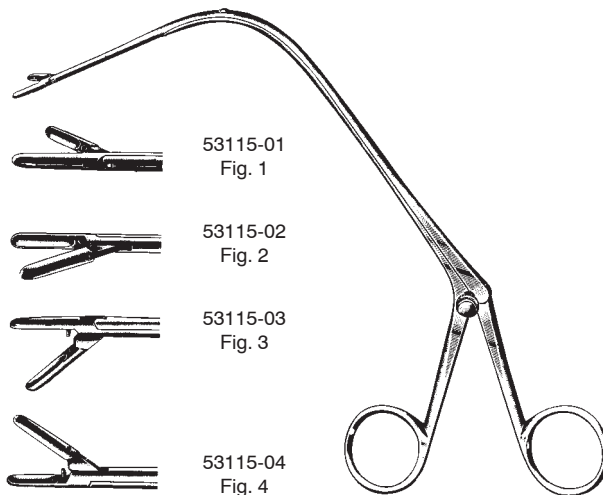

53115-01  
 Fig. 1

53115-02  
 Fig. 2

53115-03  
 Fig. 3

53115-04  
 Fig. 4

JURASZ  
 53115-01 - 53115-04  
 23 cm, 9"



REICHERT  
 53121-24  
 24 cm, 9 1/2"

Universalgriffe, Verlängerungsrohre, Aufsätze  
 Universal Handles, Interchangeable Tips, Tubes  
 Mangos universales y Tubos de extension, Puntas  
 Manici universali e Tubi di prolungamento, Terminale laringeo

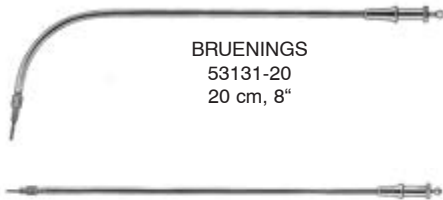

BRUENINGS  
 53131-20  
 20 cm, 8"

- |          |                |          |                |
|----------|----------------|----------|----------------|
| 53132-20 | 20 cm, 8"      | 53132-50 | 50 cm, 19 3/4" |
| 53132-30 | 30 cm, 11 3/4" | 53132-60 | 60 cm, 23 1/2" |
| 53132-40 | 40 cm, 15 3/4" |          |                |



HUBER  
 53130-00



FRAENKEL  
 53150-00



SEIFERT  
 53152-00



FRAENKEL  
 53154-00



SCHEINMANN  
 53155-00



SCHEINMANN  
 53157-00

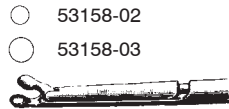

- 53158-02
  - 53158-03
- BRUENINGS  
 53158-02 - 53158-03

- 53160-02

- 53160-03



BRUENINGS  
 53160-02 - 53160-03



LANGE  
 53162-00

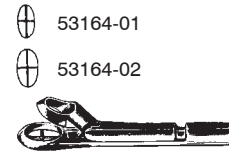

- ⊕ 53164-01
  - ⊕ 53164-02
- KRAUSE  
 53164-01 - 53164-02



KRAUSE  
 53166-00



SCHUMACHER  
 53170-00



BARACANI  
 53175-00

- ⊕ 53177-01

- ⊕ 53177-02



CORDES  
 53177-01 - 53177-02



Broncho-Oesophagoskopiezangen, Kehlkopfspiegel, Griffe  
 Broncho-Esophagscopy Forceps, Laryngeal Mirrors, Handles  
 Pinzas para bronco-esofagoscopia, Espejos laringeos, Mangos  
 Pinze per bronco-esofagoscopia, Specchi laringei, Manici

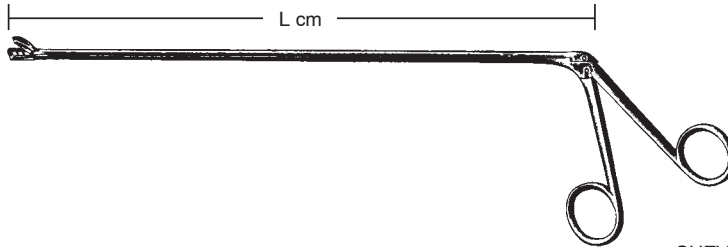

CHEVALIER-JACKSON  
53230-01 - 53260-08



cm	Fig. 1	Fig. 2	Fig. 3	Fig. 4	Fig. 5	Fig. 6	Fig. 7	Fig. 8
30 / 11 <sup>3</sup> / <sub>4</sub> "	53230-01	53230-02	53230-03	53230-04	53230-05	53230-06	53230-07	53230-08
40 / 15 <sup>3</sup> / <sub>4</sub> "	53240-01	53240-02	53240-03	53240-04	53240-05	53240-06	53240-07	53240-08
50 / 19 <sup>3</sup> / <sub>4</sub> "	53250-01	53250-02	53250-03	53250-04	53250-05	53250-06	53250-07	53250-08
60 / 23 <sup>1</sup> / <sub>2</sub> "	53260-01	53260-02	53260-03	53260-04	53260-05	53260-06	53260-07	53260-08

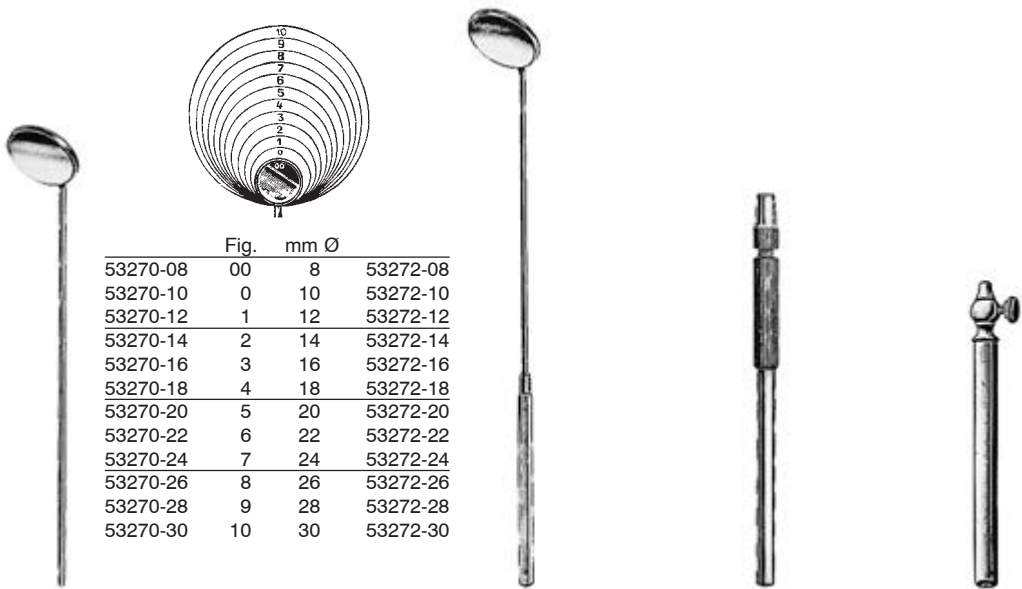

	Fig.	mm Ø	
53270-08	00	8	53272-08
53270-10	0	10	53272-10
53270-12	1	12	53272-12
53270-14	2	14	53272-14
53270-16	3	16	53272-16
53270-18	4	18	53272-18
53270-20	5	20	53272-20
53270-22	6	22	53272-22
53270-24	7	24	53272-24
53270-26	8	26	53272-26
53270-28	9	28	53272-28
53270-30	10	30	53272-30

53270-08 - 53270-30

53272-08 - 53272-30

53274-12

53276-10

Mikro-Rohrschaftzangen  
 Micro Laryngeal Forceps  
 Pinzas para la micro-cirugía de la laringe  
 Pinze ad asta tubolare per microchirurgia

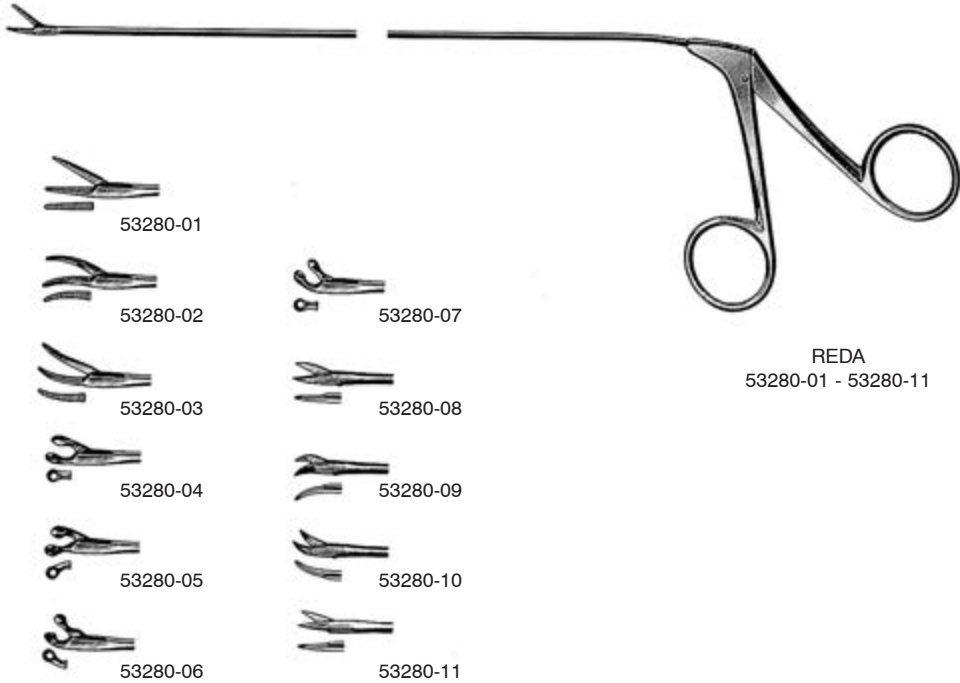

REDA  
 53280-01 - 53280-11

**REDA Mikro-Rohrschaftzangen 22 cm (8 3/4")**

- 53280-01 gerieftes Maul, gerade 1,5 x 10 mm
- 53280-02 gerieftes Maul, links gebogen 1,5 x 8,5 mm
- 53280-03 gerieftes Maul, rechts gebogen 1,5 x 8,5 mm
- 53280-04 Löffelmaul, gerade 2,5 mm
- 53280-05 Löffelmaul, links abgewinkelt 2,5 mm
- 53280-06 Löffelmaul, rechts abgewinkelt 2,5 mm
- 53280-07 Löffelmaul, aufwärts abgewinkelt 2,5 mm
- 53280-08 Schere, gerade, vertikal
- 53280-09 Schere, links gebogen
- 53280-10 Schere, rechts gebogen
- 53280-11 Schere, horizontal schneidend, gerade

**REDA Micro-Laryngeal Forceps 22 cm (8 3/4")**

- 53280-01 Grasping tip, straight, serrated, 1,5 x 10 mm
- 53280-02 Grasping tip, curved to left, serrated, 1,5 x 8,5 mm
- 53280-03 Grasping tip, curved to right, serrated, 1,5 x 8,5 mm
- 53280-04 Cup forceps, straight, 2,5 mm
- 53280-05 Cup forceps, angled to left, 2,5 mm
- 53280-06 Cup forceps, angled to right, 2,5 mm
- 53280-07 Cup forceps, angled up, 2,5 mm
- 53280-08 Scissors, straight, vertical
- 53280-09 Scissors, curved to left
- 53280-10 Scissors, curved to right
- 53280-11 Scissors, straight, horizontal

**REDA Pinza microlaringea 22 cm (8 3/4")**

- 53280-01 boca estriada recta 1,5 x 10 mm
- 53280-02 boca estriada curva a la izquierda 1,5 x 8,5 mm
- 53280-03 boca estriada curva a la derecha 1,5 x 8,5 mm
- 53280-04 boca redonda cortante recta 2,5 mm Ø
- 53280-05 boca redonda cortante angulada al la izquierda 2,5 mm Ø
- 53280-06 boca redonda cortante angulada a la derecha 2,5 mm Ø
- 53280-07 boca redonda cortante angulada hacia arriba 2,5 mm Ø
- 53280-08 Tijera recta corte vertical
- 53280-09 Tijera curva a la izquierda
- 53280-10 Tijera curva a la derecha
- 53280-11 Tijera recta corte horizontal

**REDA Pinze ad asta tubolare per microchirurgia 22 cm (8 3/4")**

- 53280-01 morsi zigrinati, retti, 1,5 x 10 mm
- 53280-02 morsi zigrinati, curvi a sinistra, 1,5 x 8,5 mm
- 53280-03 morsi zigrinati, curvi a destra, 1,5 x 8,5 mm
- 53280-04 morsi a forma di cucchiaino rotondo retto, 2,5 mm
- 53280-05 morsi a forma di cucchiaino rotondo angolati a sinistra, 2,5 mm
- 53280-06 morsi a forma di cucchiaino rotondo angolati a destra, 2,5 mm
- 53280-07 morsi a forma di cucchiaino rotondo angolati in alto, 2,5 mm
- 53280-08 forbici, rette, taglio verticale
- 53280-09 forbici, curve a sinistra
- 53280-10 forbici, curve a destra
- 53280-11 forbici, rette, taglio orizzontale

Instrumente für Laryngoskopie  
 Instruments for Laryngology  
 Instrumentos Laringoscopia  
 Strumenti per la Laringoscopia

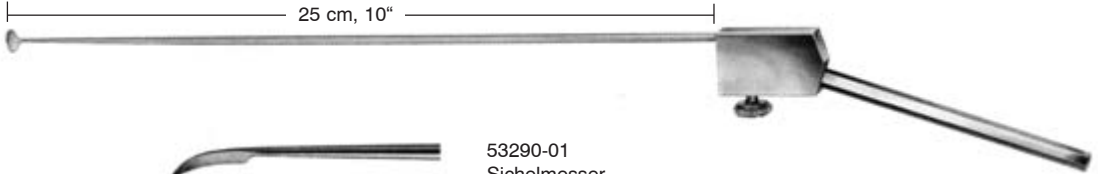

53290-01  
 Sichelmesser  
 micro-laryngeal sickle  
 microlaringeo cuchillo de hoz  
 Coltello falcato



53290-02  
 Schälmesser, quer, oval  
 micro-laryngeal separador oval, horizontal  
 microlaringeo separador ovalado, horizontal  
 Seperatore ovale verticale



53290-03  
 Schälmesser, längs, oval  
 micro-laryngeal separador oval, vertical  
 microlaringeo separador ovalado, vertical  
 Seperatore ovale orizzontale



53290-04  
 Schälmesser, 45° abgewinkelt  
 micro-laryngeal round cutting knife, 45° angled  
 microlaringeo cuchillo para cortes redondos, 45° angulado  
 Seperatore angolato 45°



53290-05  
 Häkchen, 90° gebogen stumpf  
 micro-laryngeal hook 90° angled, blunt  
 microlaringeo ganchito 90° angulado, romo  
 Uncino angolato 90° smusso



53290-06  
 Häkchen, 30° retrograd gebogen  
 micro-laryngeal probe, 30° backwards curved blunt with button  
 microlaringeo ganchito, 30° curvo retrogrado  
 Uncino angolato retrogrado 30°



53290-07  
 Fadengabel  
 micro-laryngeal ligatore adjuster  
 microlaringeo horquilla de hilos  
 Forchetta da sutura

53290-08  
 Handgriff für Stabinstrumente  
 Handle for microlaryngeal instruments  
 Mango para microlaringeos instrumentos  
 Manico per strumenti microlaringei



Tracheal Dilatoren, Trachealhaken, Tracheal-Wundspreizer

Trachea Dilators, Trachea hooks, Tracheal Retractors

Dilatadores para la tráquea, Ganchos para traqueotomía, Retractor traqueal

Dilatatori per tracheotomia, Ganci per tracheotomia, Divaricatori tracheali

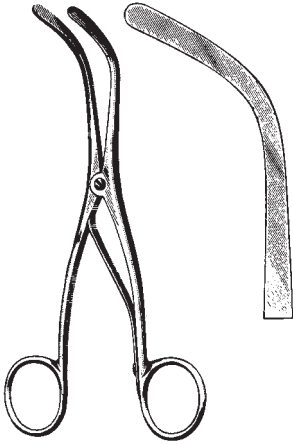

TROUSSEAU-BABY  
55111-13 13 cm, 5 1/8"

TROUSSEAU  
55111-14 14 cm, 5 1/2"

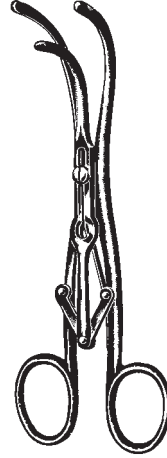

LABORDE  
55113-14  
14 cm, 5 1/2"



BOSE  
55115-07  
7 cm, 2 3/4"



JACKSON  
55116-15  
15 cm, 6"



JACKSON  
55117-17  
17 cm, 6 3/4"

Trachealhaken, Kanüle  
 Trachea Hooks, Tubes  
 Ganchos para traqueotomía, Cánula  
 Ganci per tracheotomia, Cannule



ITERSON  
 55118-16 - 55119-16  
 16 cm, 6 1/4"



NEWS  
 55120-15  
 15 cm, 6"

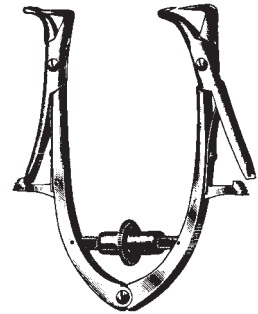

FRIEDMANN  
 71351-10 10 cm, 4"  
 71351-15 15 cm, 6"

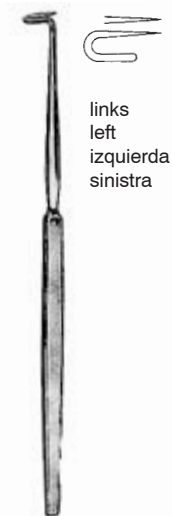

BOSE  
 55122-16  
 16 cm, 6 1/4"

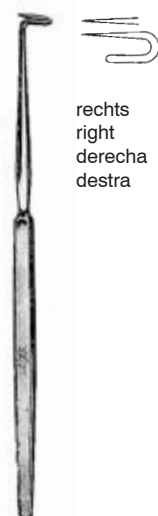

BOSE  
 55124-16  
 16 cm, 6 1/4"



WAGENER-MOSHER  
 55151-05 5 mm  
 55151-07 7 mm  
 55151-09 9 mm



Tracheal-Kanülen, Schilddrüsenhaken, Sonde, Kropffabzange, Muskelklemme  
 Tracheal Tubes, Thyroid Gland Retractor, Directors-Enucleators, Goitre Seizing Forceps, Muscular Clamp  
 Cánulas traqueales, Separador para la glándula tiroidea, Sondas,  
 Pinza para coger el bocio, Pinza-clamp para músculos  
 Cannule tracheali, Divaricatori per la tiroide, Sonde, Pinze per gozzo, Pinza muscolare



LUER

Neusilber  
 German silver  
 alpaca  
 argentone



CHEVALIER-JACKSON

Neusilber  
 German silver  
 alpaca  
 argentone

Fig.	Ø mm	Länge des Außenrohrs Length of outer tube Largo de la cánula exterior Lunghezza del tubo esterno
0	4	45 mm
1	5	50 mm
2	6	55 mm
3	7	60 mm
4	8	65 mm
5	9	70 mm
6	10	75 mm
7	11	80 mm
8	12	85 mm
9	13	90 mm

55220-04
55220-05
55220-06
55220-07
55220-08
55220-09
55220-10
55220-11
55220-12
55220-13

55240-04
55240-05
55240-06
55240-07
55240-08
55240-09
55240-10
55240-11
55240-12
55240-13

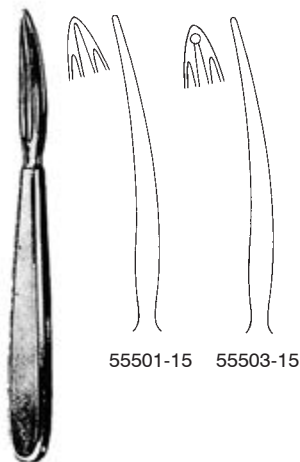

55501-15 55503-15

KOCHER  
 55501-15 - 55503-15  
 15 cm, 6"



SCHOENBORN  
 55511-21  
 21 cm, 8 1/4"



LAHEY  
 55520-15 15 cm, 6"  
 55520-20 20 cm, 8"

MASTIN  
 55523-17  
 17 cm, 6 3/4"

Rippenscheren  
Rib Shears  
Costótomos  
Costotomi



COLLIN  
57102-23  
23 cm, 9"



57105-22  
22 cm, 8 3/4"



GLUCK  
57107-22  
22 cm, 8 3/4"

mit ziehendem Schnitt  
with eccentric sliding blade  
con hoja de retroacción  
con lama di retroazione



STILLE  
57111-21  
21 cm, 8 1/4"



CORYLLOS  
57125-35  
35 cm, 13 3/4"

CORYLLOS  
57123-35  
35 cm, 13 3/4"



Rippenscheren, Sternumscheren  
Rib Shears, Sternum Scissors  
Costótomos, Tijeras de esternón  
Costotomi, Forbici per sterno



BETHUNE  
57126-34  
34 cm, 13 1/2"



SAUERBRUCH  
57131-26  
26 cm, 10 1/4"



GIERTZ-STILLE  
57137-27  
27 cm, 10 1/2"



SCHUMACHER  
57138-21  
21 cm, 8 1/4"



SAUERBRUCH-FREY  
57141-36  
36 cm, 14.2"

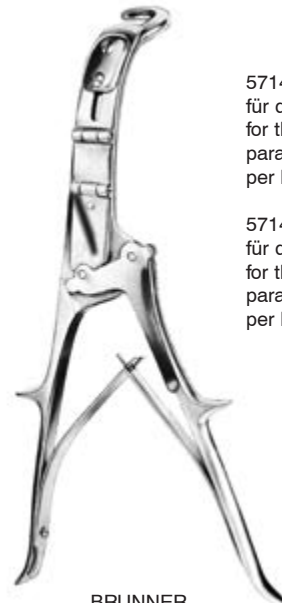

BRUNNER  
57146-28 - 57147-28  
28 cm, 11"

57146-28  
für die rechte Hand  
for the right hand  
para la mano derecha  
per la mano destra

57147-28  
für die linke Hand  
for the left hand  
para la mano izquierda  
per la mano sinistra

Rippensperrer  
Rib Spreaders  
Separadores costales  
Divaricatori costali

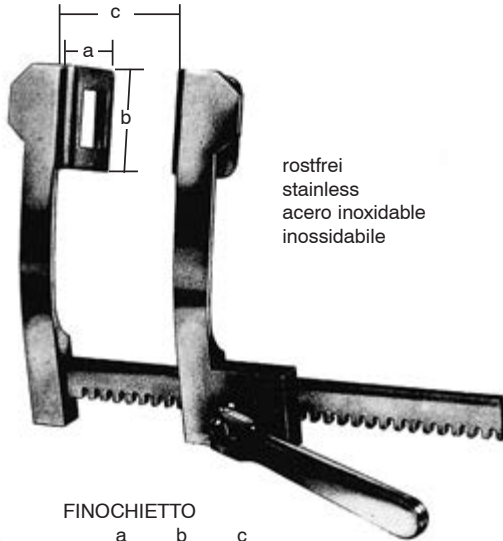

rostfrei  
stainless  
acero inoxidable  
inossidabile

FINOCHIETTO

	a	b	c
	mm	mm	mm
57210-16	38	44	160
57210-20	52	62	200
57210-25	65	85	250

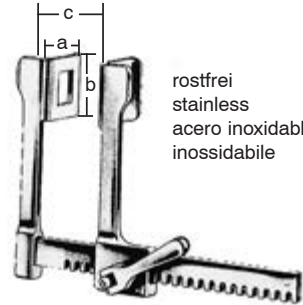

rostfrei  
stainless  
acero inoxidable  
inossidabile

FINOCHIETTO-BABY

	a	b	c
	mm	mm	mm
57214-75	18	20	75

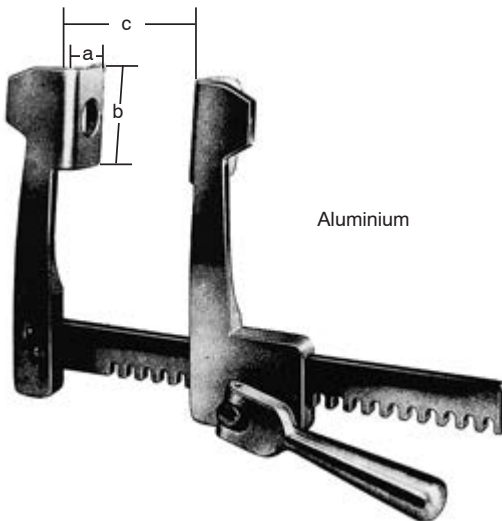

Aluminium

FINOCHIETTO

	a	b	c
	mm	mm	mm
57230-13	38	44	135
57230-17	52	62	175
57230-18	85	65	175

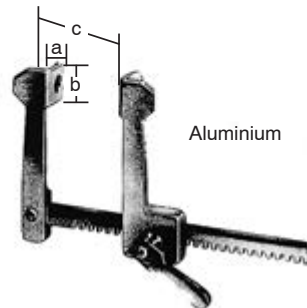

Aluminium

FINOCHIETTO-BABY

	a	b	c
	mm	mm	mm
57234-75	15	15	75

Rippensperrer  
Rib Spreaders  
Separadores costales  
Divaricatori costali

FINOCHIETTO-BURFORD			
	a	b	c
	mm	mm	mm
57236-20	65	62	200
	47	62	
57236-25	65	62	250
	47	62	
57236-30	65	62	300
	47	52	



rostfrei  
stainless  
acero inoxidable  
inossidabile

Erwachsene  
Adult Size  
para adultos  
per adulti

FINOCHIETTO-BURFORD			
	a	b	c
	mm	mm	mm
57242-20	47	62	200
	65	62	
57242-25	47	62	250
	65	62	
57242-30	47	62	300
	65	62	



Aluminium

Kinder  
Child Size  
para niños  
per bambini

FINOCHIETTO-BURFORD			
	a	b	c
	mm	mm	mm
57244-13	34	42	135
	48	42	



Aluminium

Rippensperrer  
Rib Spreaders  
Separadores costales  
Divaricatori costali

FINOCHIETTO			
	a	b	c
	mm	mm	mm
57245-13	14	14	120

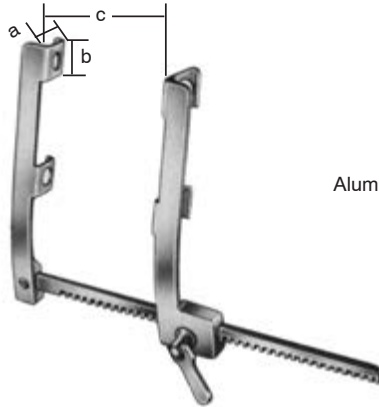

Aluminium

MORSE			
	a	b	c
	mm	mm	mm
57246-16	17	22	160

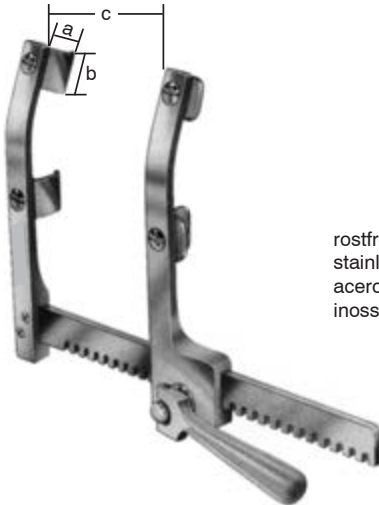

rostfrei  
stainless  
acero inoxidable  
inossidabile

MORSE-FAVALORO			
	a	b	c
	mm	mm	mm
57246-21	19	27	210



rostfrei  
stainless  
acero inoxidable  
inossidabile

Rippensperrer  
Rib Spreaders  
Separadores costales  
Divaricatori costali

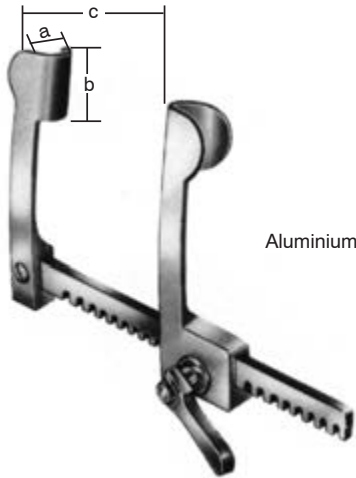

Aluminium

COOLEY-NEONATAL

	a	b	c
	mm	mm	mm
57247-95	12	16	95

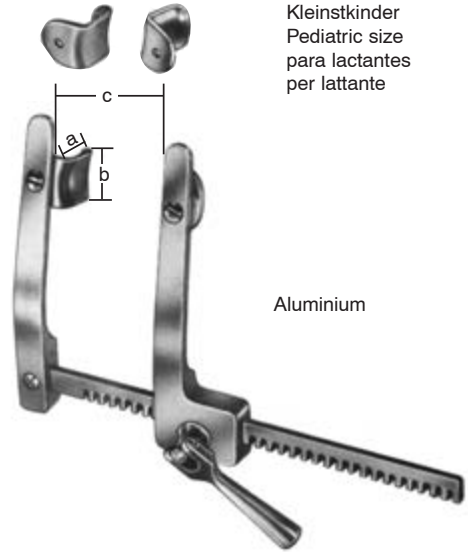

Kleinstkinder  
Pediatric size  
para lactantes  
per lattante

Aluminium

COOLEY

	a	b	c
	mm	mm	mm
57249-01	10	14	90

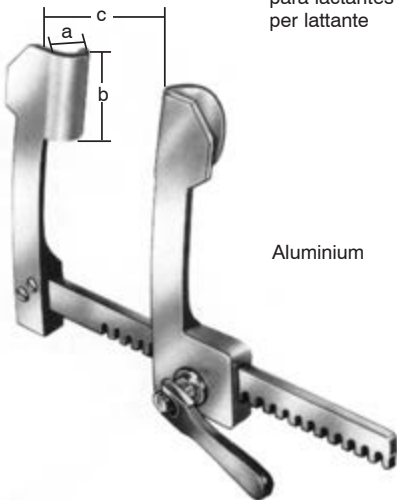

Kleinstkinder  
Pediatric size  
para lactantes  
per lattante

Aluminium

COOLEY

	a	b	c
	mm	mm	mm
57248-14	15	30	140

Rippensperrer  
 Rib Spreaders  
 Separadores costales  
 Divaricatori costali

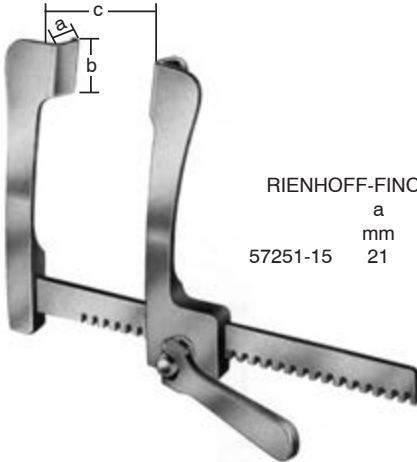

	a	b	c
	mm	mm	mm
57251-15	21	26	150

rostfrei  
 stainless  
 acero inoxidable  
 inossidabile

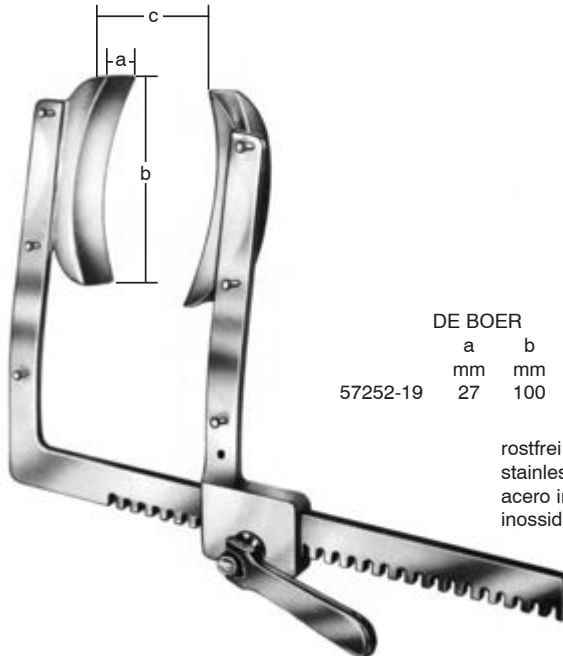

	a	b	c
	mm	mm	mm
57252-19	27	100	190

rostfrei  
 stainless  
 acero inoxidable  
 inossidabile

Rippensperrer  
Rib Spreaders  
Separadores costales  
Divaricatori costali

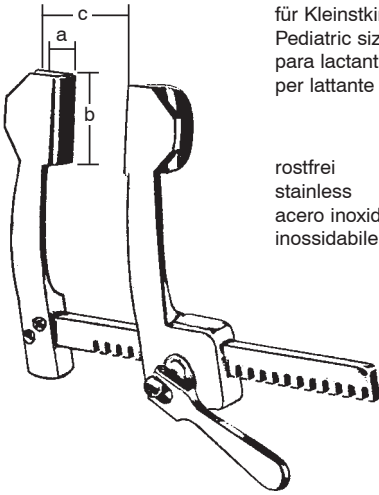

für Kleinstkinder  
Pediatric size  
para lactantes  
per lattante

rostfrei  
stainless  
acero inoxidable  
inossidabile

COOLEY

	a	b	c
	mm	mm	mm
57260-02	16	30	105
57260-03	21	44	150

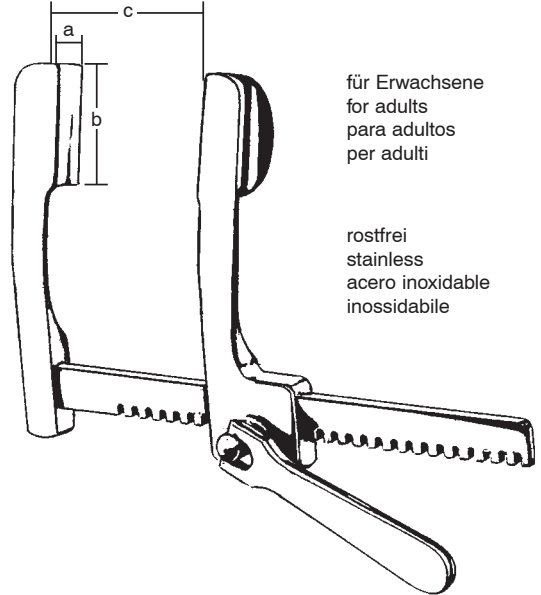

für Erwachsene  
for adults  
para adultos  
per adulti

rostfrei  
stainless  
acero inoxidable  
inossidabile

COOLEY

	a	b	c
	mm	mm	mm
57260-04	37	49	200



rostfrei  
stainless  
acero inoxidable  
inossidabile

HAIGHT

	a	b	c	h
	mm	mm	mm	mm
57260-06	30	30	90	65
57260-09	30	30	90	90



rostfrei  
stainless  
acero inoxidable  
inossidabile

TUFFIER

	a	b	c
	mm	mm	mm
57264-16	50	45	165

Sternum-Sperrer  
Sternum Retractors

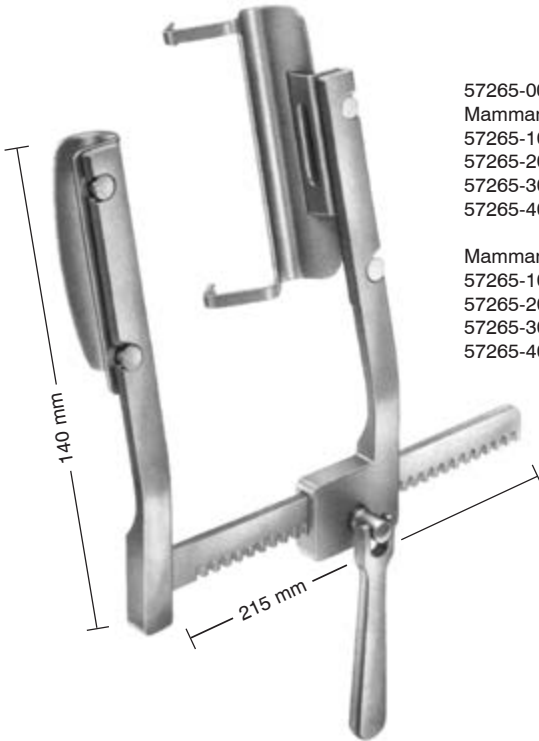

57265-00

Mammaria Sperrer, komplett bestehend aus:

57265-10 Sperrer allein

57265-20 Mammariablatt, komplett mit Aufnahmeblatt links und rechts

57265-30 1 Paar Sternumblätter 30x100 mm

57265-40 1 Paar Sternumblätter 40x100 mm

Mammaria spreader, complete consisting of:

57265-10 Retractor only

57265-20 Mammariablade complete with holding blades left and right

57265-30 1 pair of sternum blades 30x100 mm

57265-40 1 pair of sternum blades 40x100 mm



57265-20

Mammariablatt, komplett  
Mammariablade, complete



57265-30

Sternumblätter 30x100 mm  
Sternum blades 30x100 mm



57265-40

Sternumblätter 40x100 mm  
Sternum blades 40x100 mm





Laminektomie-Sperrer  
Laminectomy-Retractor  
Separadores para laminectomía  
Divaricatori Laminectomia

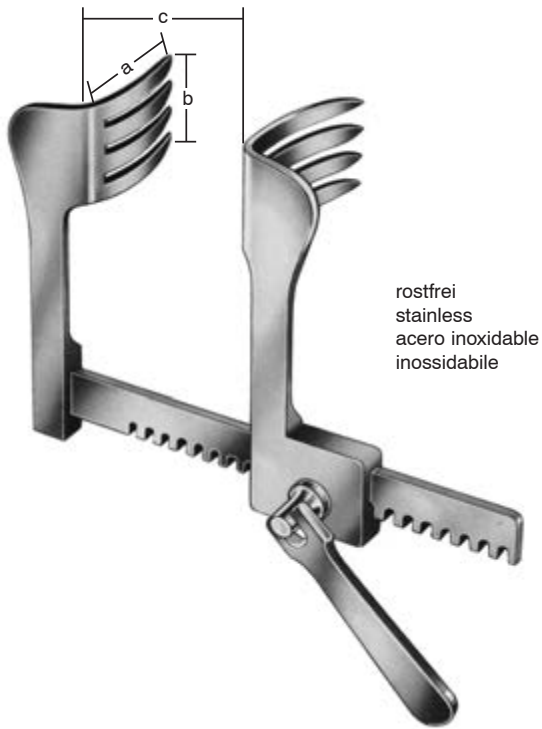

CHERRY

	a	b	c
	mm	mm	mm
57266-13	44	70	135

Thoraxsperrer  
Thoracic retractor  
Separador torácico  
Divaricatore per il torace



MERCEDES compl.  
57270-00

57270-80  
Sperrer allein  
Retractor only  
Separador solo  
Divaricatore solo

rostfrei  
stainless  
acero inoxidable  
inossidabile

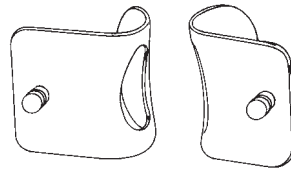

57270-65  
42x65 mm

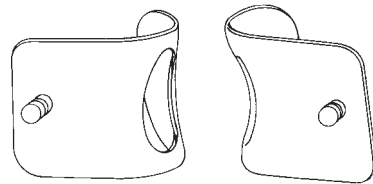

57270-75  
75x75 mm

Rippenkontraktoren  
 Rib Contractors  
 Aproximadores para costillas  
 Approssimatori costali



SELLORS  
 57280-19  
 20 cm, 8"



BAILEY-BABY  
 57283-14  
 14 cm, 5 1/2"



BAILEY  
 57284-16  
 16 cm, 6 1/4"

kurze Klauen  
 short claws  
 garras cortas  
 pinze corte



BAILEY-GIBBON  
 57286-16  
 16 cm, 6 1/4"

lange Klauen  
 long claws  
 garras largas  
 pinze lunghe

Lungenspatel  
Lung Spatulas  
Espátulas pulmonares  
Spatole per polmone



57288-30  
30 cm, 11 <sup>3</sup>/<sub>4</sub>"

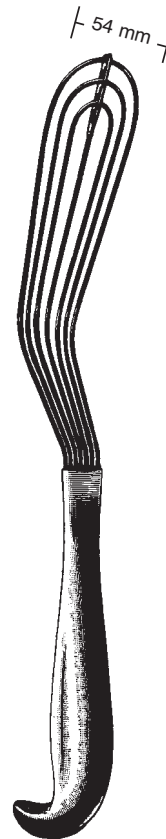

ALLISON  
57289-32  
32 cm, 12 <sup>3</sup>/<sub>4</sub>"

Lungenfaßzange, Bronchusklemmen  
 Lung Grasping Forceps, Bronchus Forceps  
 Pinzas para coger el pulmón, Pinzas clamps bronquiales  
 Pinze per afferrare il polmone, Pinze per bronchi

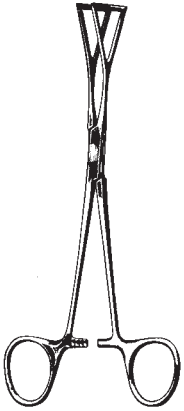

LOVELACE  
 57290-20  
 20 cm, 8"

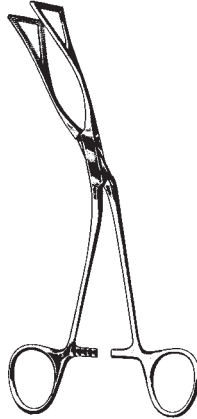

LOVELACE  
 57291-20  
 20 cm, 8"



HARRINGTON  
 57301-30  
 30,5 cm, 12"

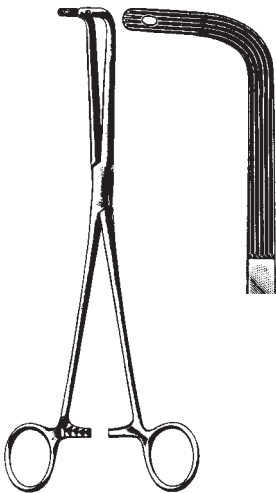

FINOCIETTO  
 57307-24  
 24 cm, 9 1/2"

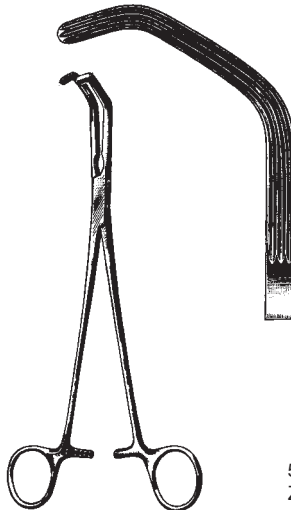

PRICE-THOMAS  
 57309-22  
 22 cm, 8 3/4"

57311-22  
 Zähne links  
 tooth left  
 dientes izquierda  
 denti sinistro



PRICE-THOMAS  
 22 cm, 8 3/4"

57313-22  
 Zähne rechts  
 tooth right  
 dientes derecha  
 denti destro

Bronchusklemmen, Gefäßklemmen  
 Bronchus Forceps, Blood Vessel Clamps  
 Pinzas clamps bronquiales, Pinzas-clamps para vasos  
 Pinze per bronchi, Pinze cardiovascolari

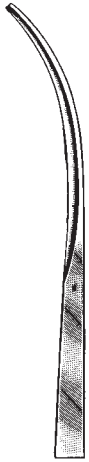

57321-23

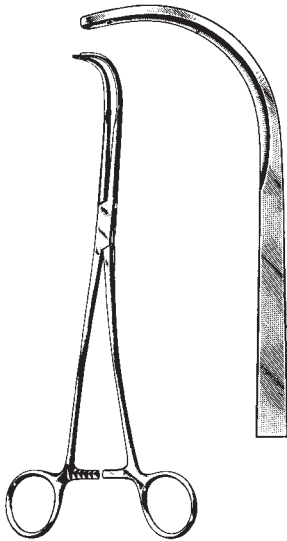

SEMB  
 23 cm, 9"

57323-23

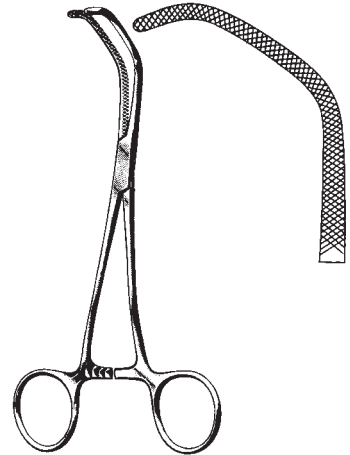

SATINSKY  
 57325-15  
 15 cm, 6"

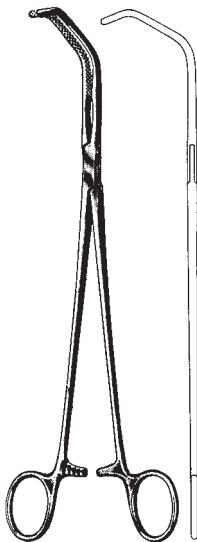

SATINSKY  
 57327-26 - 57329-26  
 26 cm, 10 1/4"

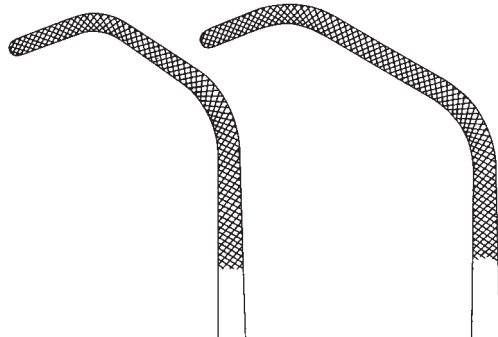
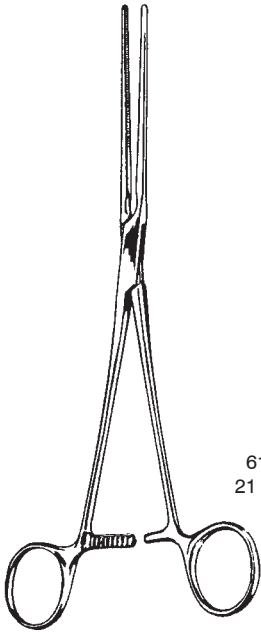

Fig. 1 57327-26

Fig. 2 57329-26

Coarctations-Klemmen  
 Coarctation clamps  
 Pinzas clamps para coartación  
 Pinza per coartazione



POTTS  
 61000-21 - 61000-22



61000-21  
 21 cm, 8 1/4"



61000-22  
 22 cm, 8 3/4"

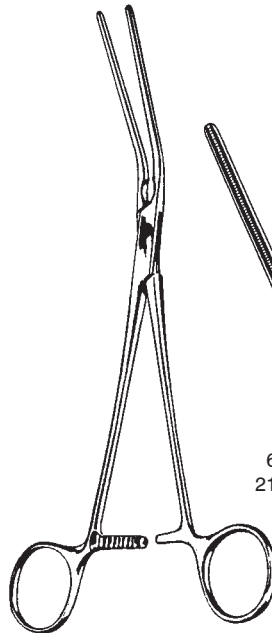

POTTS  
 61001-21 - 61001-22

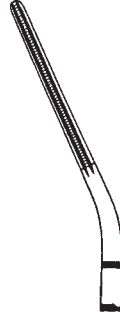

61001-21  
 21 cm, 8 1/4"

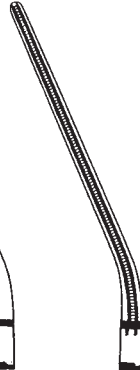

61001-22  
 22 cm, 8 3/4"

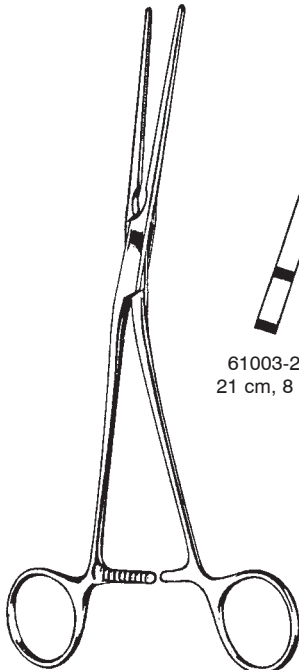

POTTS  
 61003-21 - 61003-22



61003-21  
 21 cm, 8 1/4"

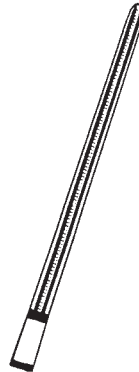

61003-22  
 22 cm, 8 3/4"





**Atrauma**

Anastomosens-Klemmen, Präparier- und Ligaturklemmen  
 Anastomosis clamps, Dissecting and ligature forceps  
 Pinzas clamps para anastomosis, Pinzas para preparaciones y ligaduras  
 Pinze per anastomosi, Pinze per preparazioni e legature

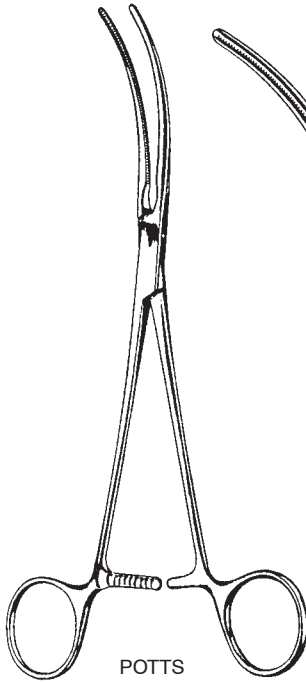

POTTS  
 61005-22  
 22 cm, 8 3/4"

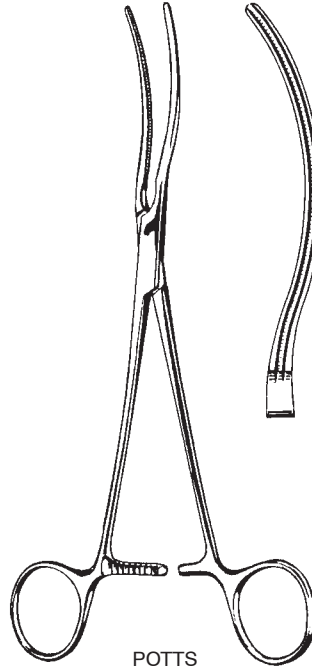

POTTS  
 61007-22  
 22 cm, 8 3/4"

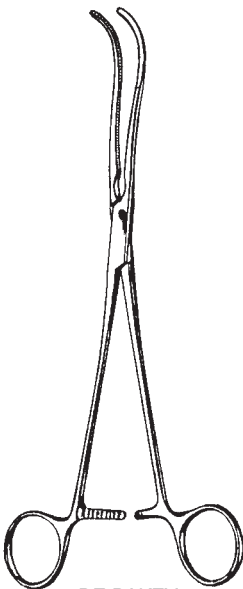

DE BAKEY  
 61008-19 - 61008-23

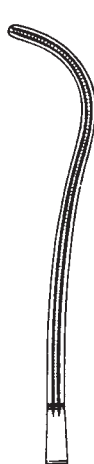

61008-19  
 19 cm, 7 1/2"



61008-23  
 23 cm, 9"

Peripheral-Gefäßklemmen  
 Peripheral vascular clamps  
 Pinzas-clamps para vasos periféricos  
 Pinze vascolari periferici

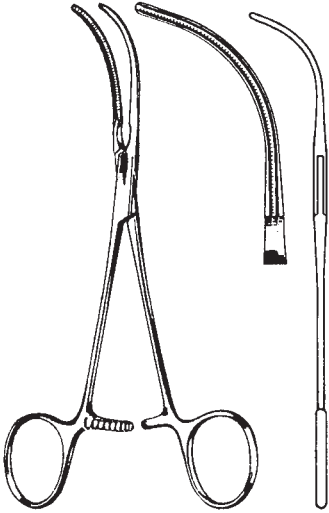

DE BAKEY  
 61009-16  
 16 cm, 6 1/4"



DALE  
 61010-18  
 18 cm, 7"

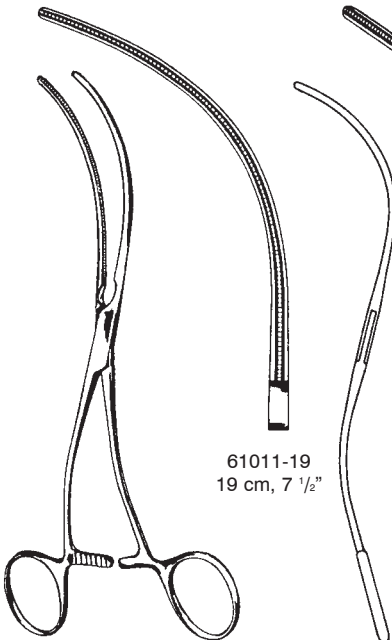

61011-19  
 19 cm, 7 1/2"

DE BAKEY  
 61011-19 - 61011-20

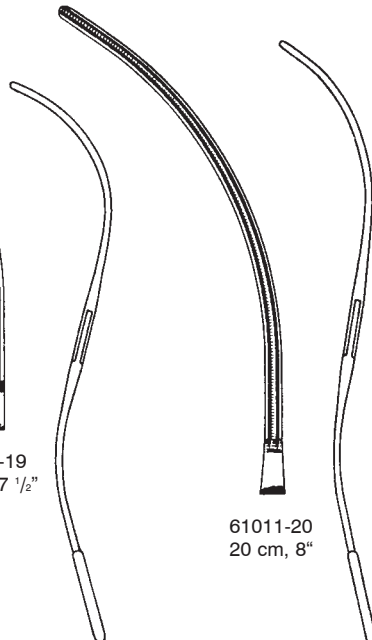

61011-20  
 20 cm, 8"

**Atrauma**

Peripheral-Gefäßklemmen  
Peripheral vascular clamps  
Pinzas-clamps para vasos periféricos  
Pinze vascolari periferici

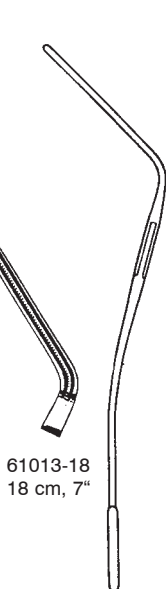
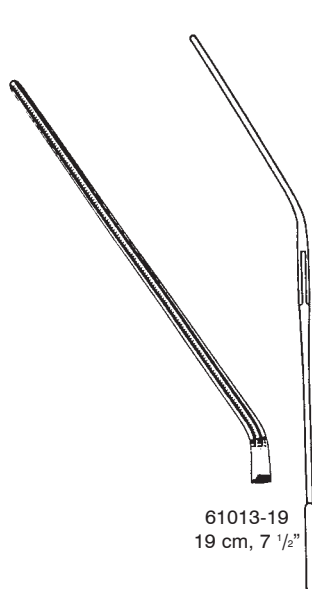
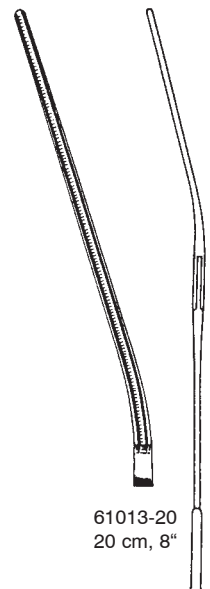

DALE

61012-17  
17,5 cm, 7"61012-18  
18 cm, 7"61012-19  
18,5 cm, 7 1/4"LELAND-JONES  
61013-18 - 61013-2061013-18  
18 cm, 7"61013-19  
19 cm, 7 1/2"61013-20  
20 cm, 8"

Mehrzweck-Gefäßklemme  
Multi Purpose Vascular Clamps  
Pinzas vasculares de usos multiples  
Pinze vascolari universali

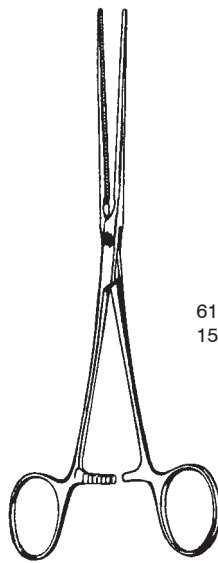

BAINBRIDGE  
61014-15 - 61014-18



61014-15  
15 cm, 6"



61014-18  
18 cm, 7"

**Atrauma**

Mehrzweck-Gefäßklemme  
Multi Purpose Vascular Clamps  
Pinzas vasculares de usos multiples  
Pinze vascolari universali

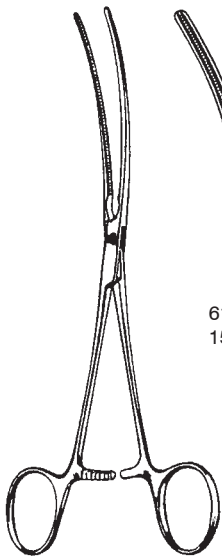

61015-15  
15 cm, 6"

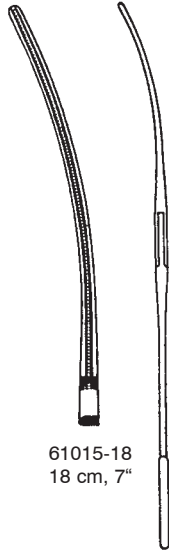

61015-18  
18 cm, 7"

BAINBRIDGE  
61015-15 - 61015-18

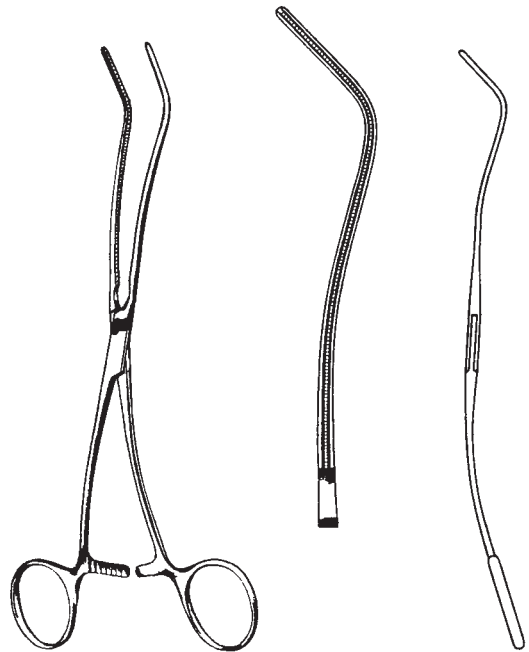

DE BAKEY  
61016-20  
20 cm, 8"

Aorta-Aneurysmaklemmen  
Aortic aneurysm clamps  
Pinzas-clamps para aneurisma de la aorta  
Pinze per aneurisma aorta

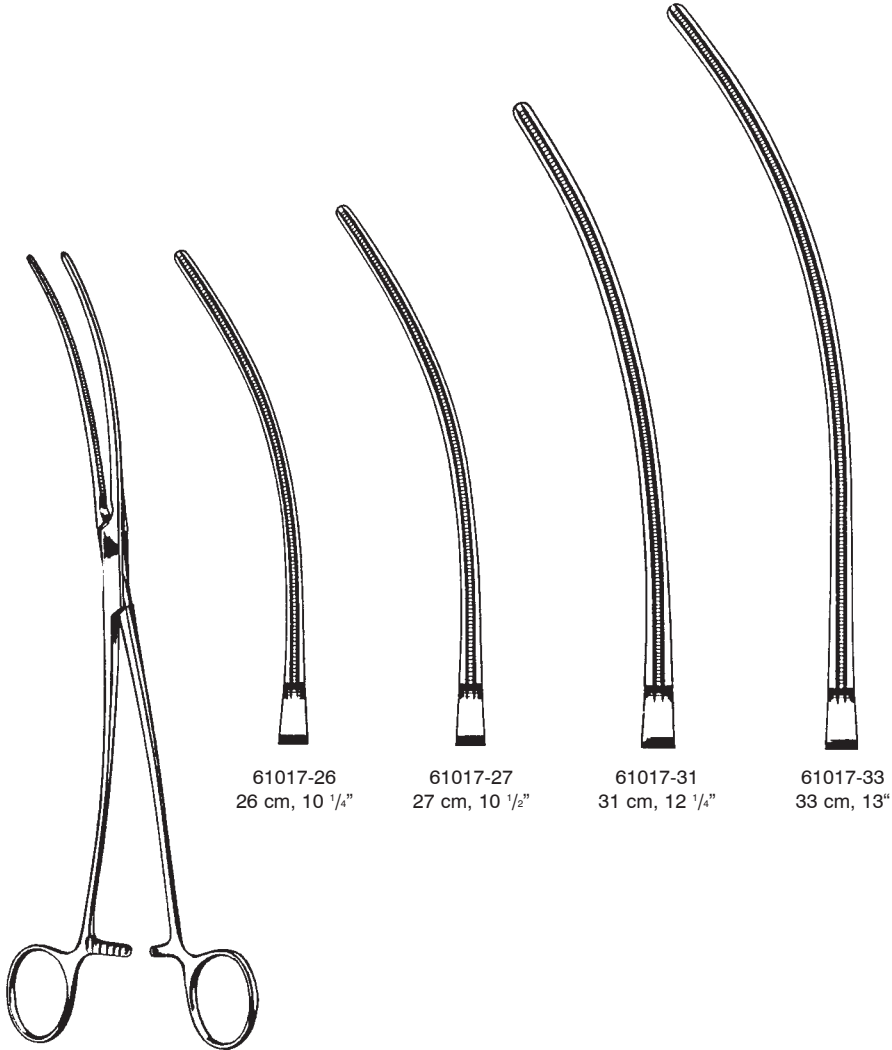

61017-26  
26 cm, 10 1/4"

61017-27  
27 cm, 10 1/2"

61017-31  
31 cm, 12 1/4"

61017-33  
33 cm, 13"

DE BAKEY  
61017-26 - 61017-33

**Atrauma**

Aorta-Aneurysmaklemmen  
Aortic aneurysm clamps  
Pinzas-clamps para aneurisma de la aorta  
Pinze per aneurisma aorta



DE BAKEY  
61018-28  
28 cm, 11"

Aorta-Aneurysmaklemmen  
Aortic aneurysm clamps  
Pinzas-clamps para aneurisma de la aorta  
Pinze per aneurisma aorta

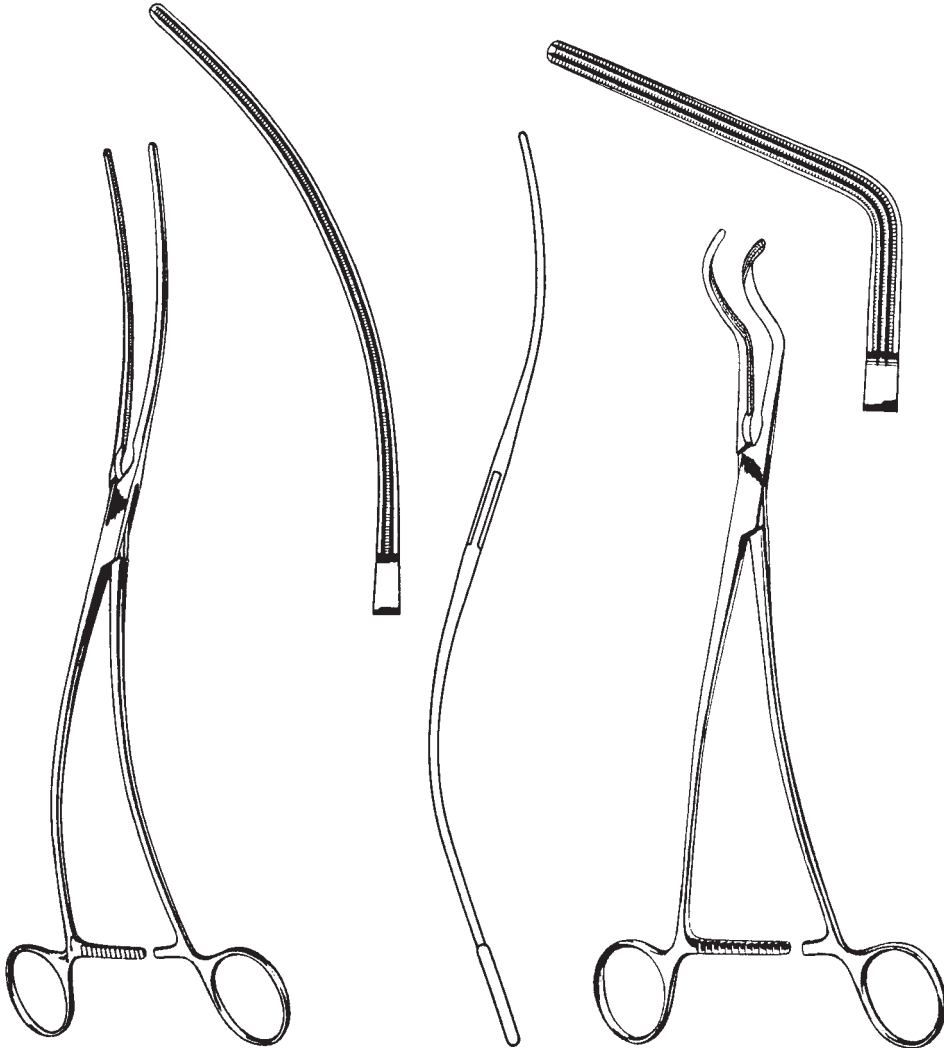

DE BAKAY  
61019-30  
30 cm, 11 <sup>3</sup>/<sub>4</sub>"

DE BAKAY  
61020-27  
27 cm, 10 <sup>1</sup>/<sub>2</sub>"



**Atrauma**

Präparier- und Ligaturklemme  
Dissecting- and Ligature clamp  
Pinzas clamps para disección, ligaduras  
Pinze per dissezione, legature

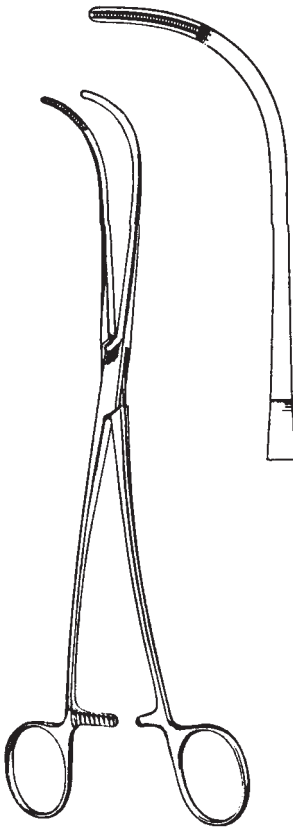

DE BAKEY  
61021-24  
24 cm, 9 1/2"



61022-01  
25 cm, 10"

61022-02  
24,5 cm, 9 3/4"

DE BAKEY-RUMEL

Ligaturklemmen  
Ligature clamps  
Pinzas clamps para ligaduras  
Pinze per legature

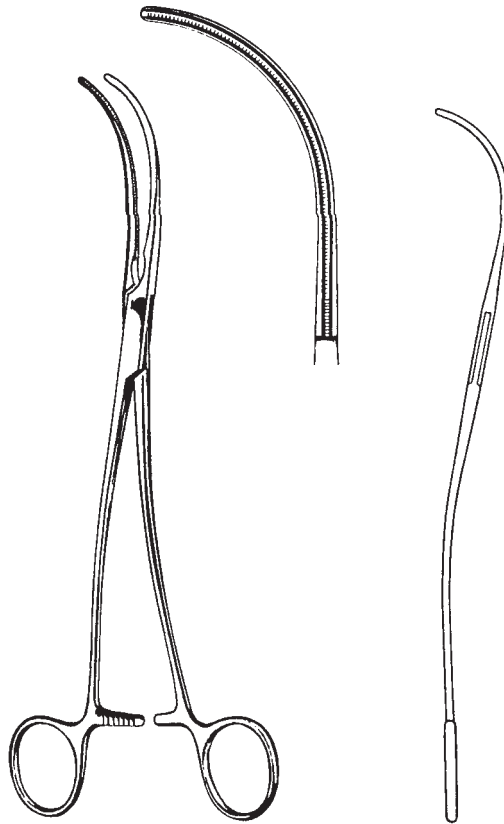

DE BAKEY  
61022-24  
24 cm, 9 1/2"

**Atrauma**

Präparier- und Ligaturklemmen  
Dissecting- and Ligature clamps  
Pinza para disección y ligatura  
Pinze per dissezione e legature



DE BAKEY-MIXTER  
61022-28  
28,5 cm, 11 1/4"

Ligaturklemme  
Ligature clamp  
Pinzas clamps para ligaduras  
Pinze per legature

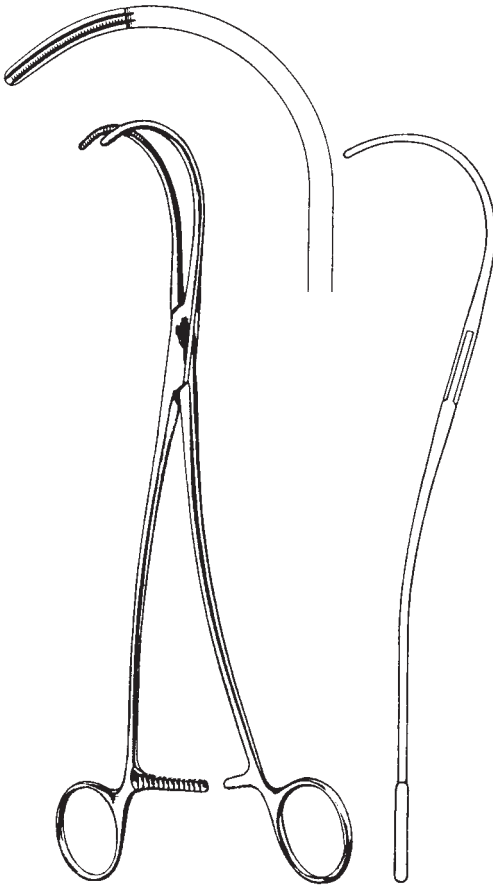

DE BAKEY  
61023-25  
25 cm, 10"

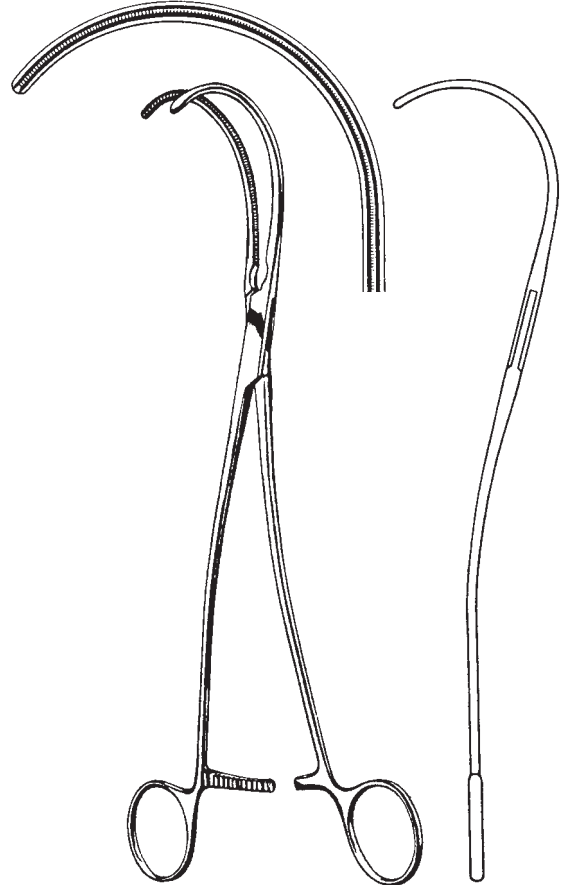

DE BAKEY  
61023-26  
26 cm, 10 1/4"

**Atrauma**

Aortaklemmen  
Aortic clamps  
Pinzas-clamps para la aorta  
Pinze per aorta

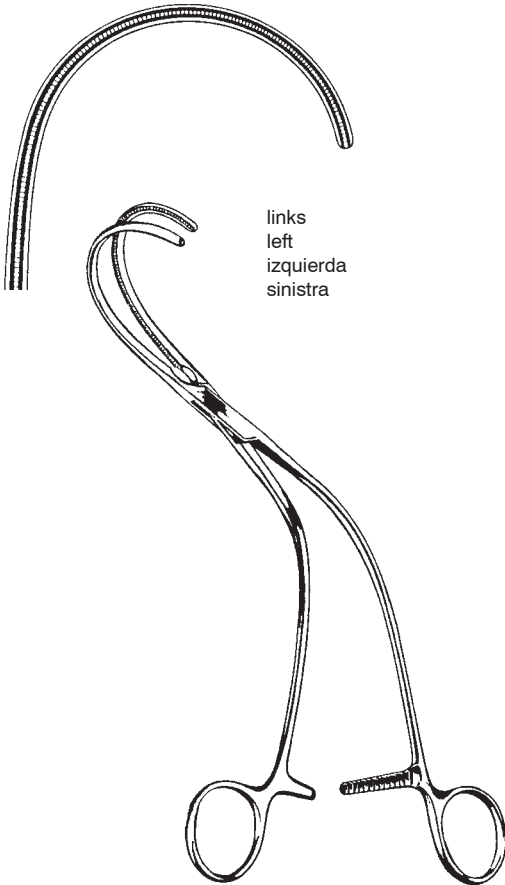

links  
left  
izquierda  
sinistra

WEBER  
61024-01  
26 cm, 10 1/4"

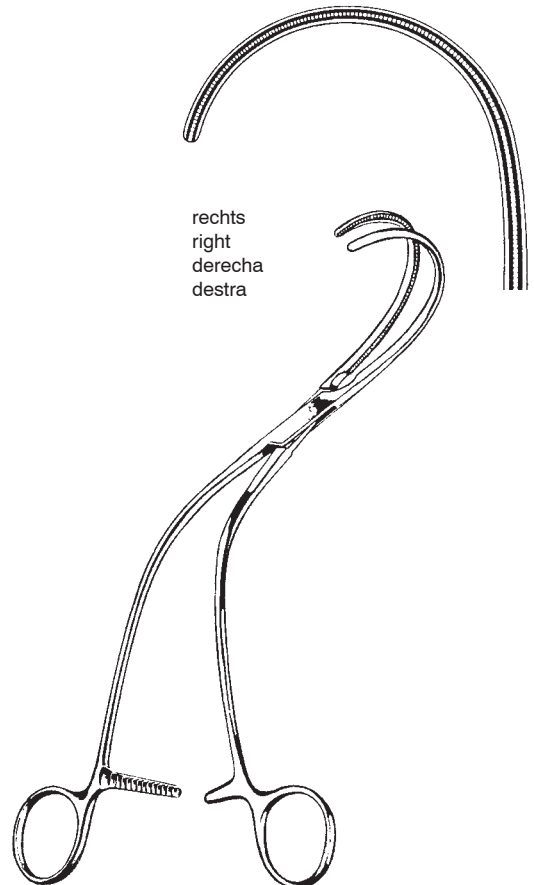

rechts  
right  
derecha  
destra

WEBER  
61024-02  
26 cm, 10 1/4"

Aortaklemmen  
Aortic clamps  
Pinzas-clamps para la aorta  
Pinze per aorta

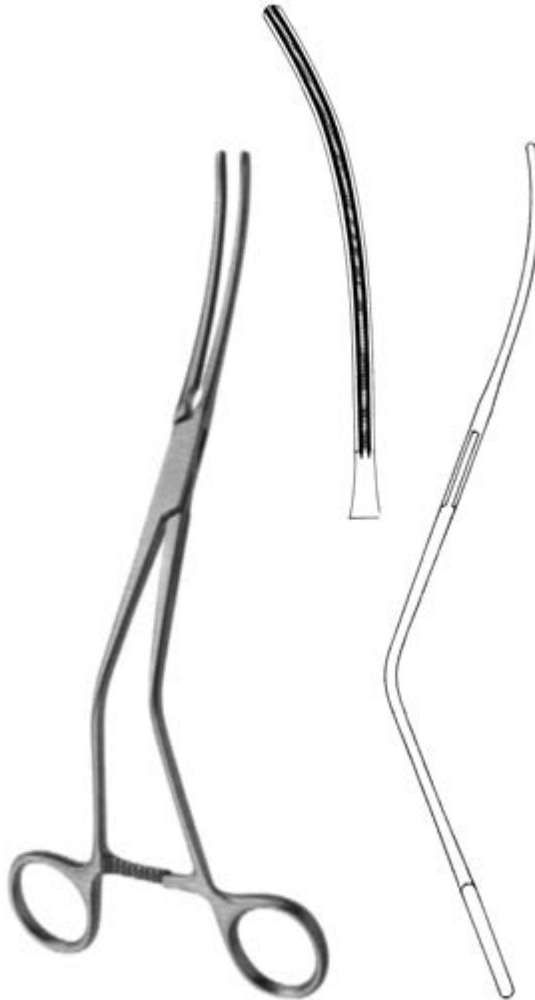

WYLIE  
61024-24  
24 cm, 9 1/2"

**Atrauma**

Aortaklemmen  
Aortic clamps  
Pinzas-clamps para la aorta  
Pinze per aorta



WYLIE  
61024-27  
27 cm, 10 1/2"

Tangentialklemmen  
 Tangential occlusion clamps  
 Pinzas-clamps para oclusión tangencial  
 Pinze per occlusione tangenziale

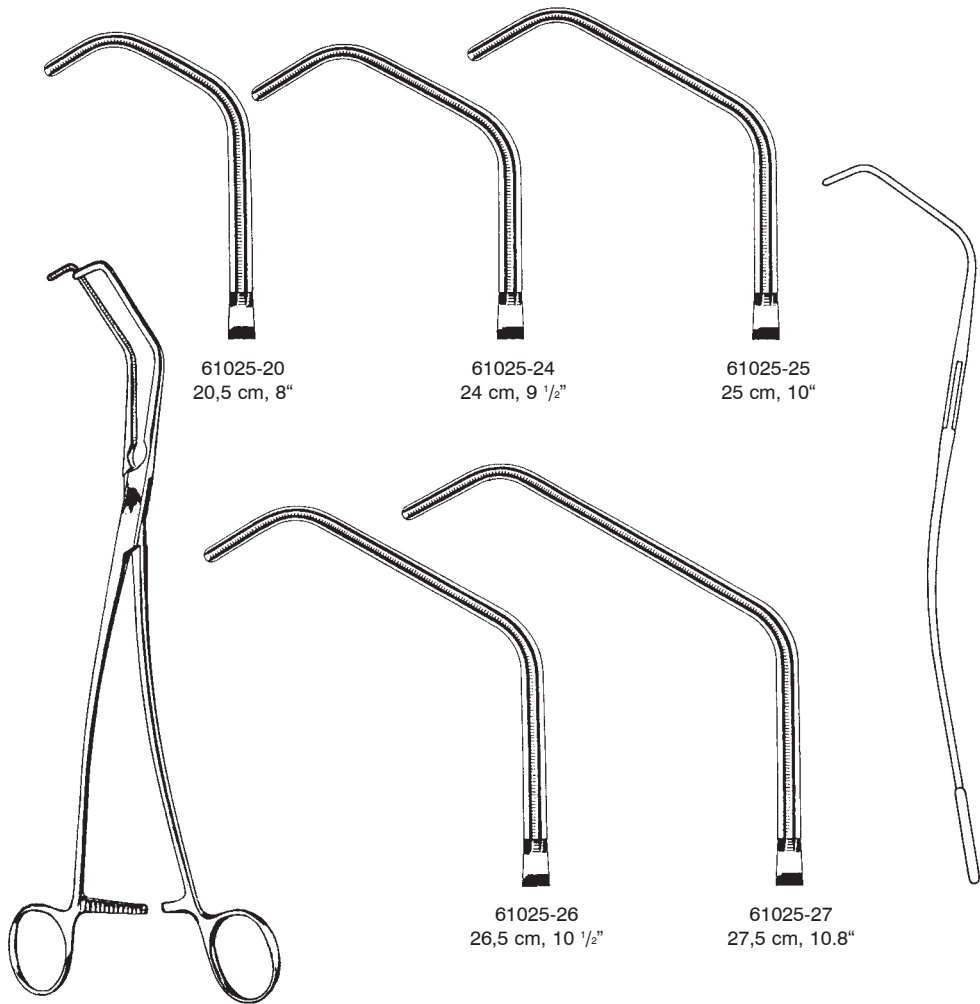

61025-20  
 20,5 cm, 8"

61025-24  
 24 cm, 9 1/2"

61025-25  
 25 cm, 10"

61025-26  
 26,5 cm, 10 1/2"

61025-27  
 27,5 cm, 10.8"

DE BAKEY-SATINSKY  
 61025-20 - 61025-27



**Atrauma**

Aurikelklemmen  
Auricle clamps  
Pinza-clamps auriculares  
Pinza auricula



HARKEN  
61026-01 - 61026-04

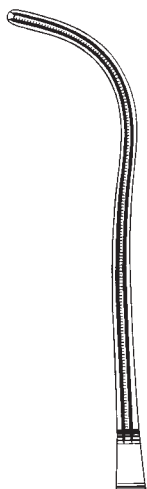

61026-01  
24 cm, 9 1/2"

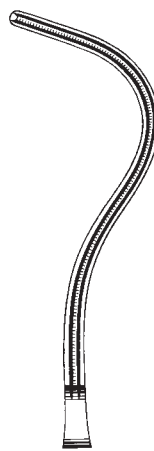

61026-02  
24 cm, 9 1/2"

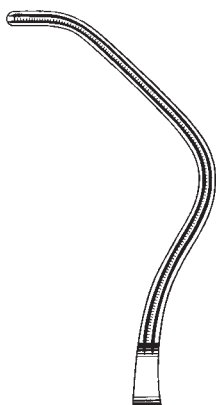

61026-03  
24 cm, 9 1/2"

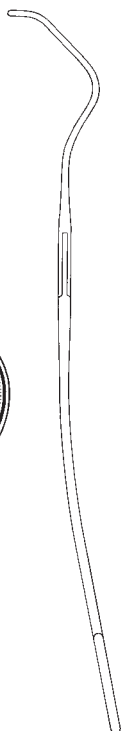

61026-04  
24 cm, 9 1/2"

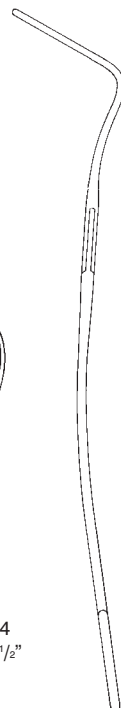

Bronchusklemmen  
 Bronchus clamp  
 Pinzas-clamps bronquiales  
 Pinze per bronchi

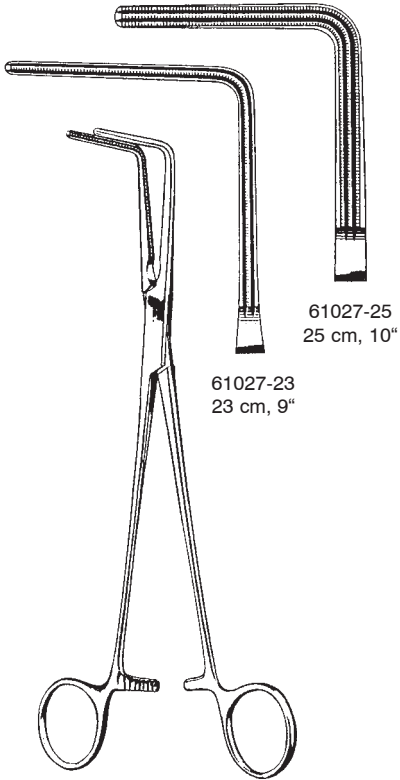

LEES  
 61027-23 - 61027-25

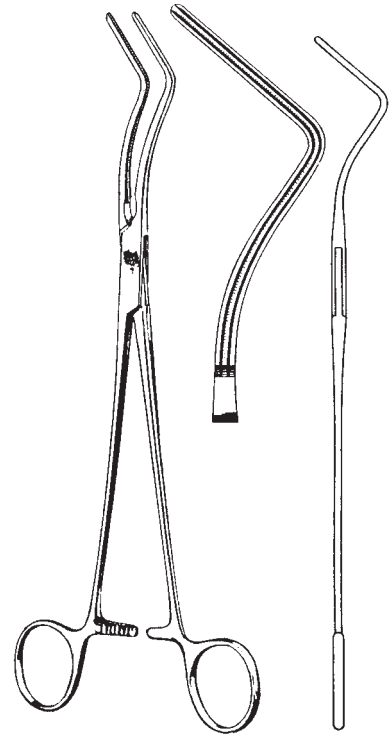

LEES  
 61029-25  
 25 cm, 10"

**Atrauma**

Aorta-Anastomosenklemmen  
Aortic anastomosis Clamps  
Pinzas-clamps para anastomosis  
Pinze anastomosi aorta

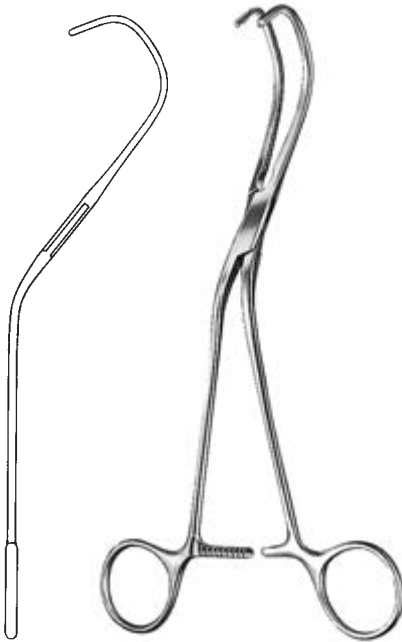

LAMBERT-KAY  
21 cm, 8 1/4"  
61030-21 - 61030-22



61030-22

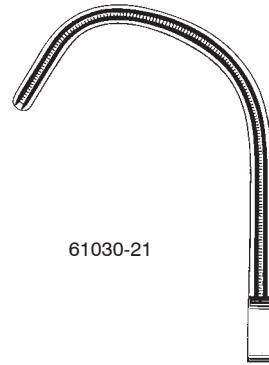

61030-21



DE BAKEY  
61031-17  
17 cm, 6 3/4"

Aorta- und Aneurysmaklemme  
 Aortic- and Aneurysm Clamps  
 Pinzas aórticas y para aneurisma  
 Pinze per aorta e per aneurisma

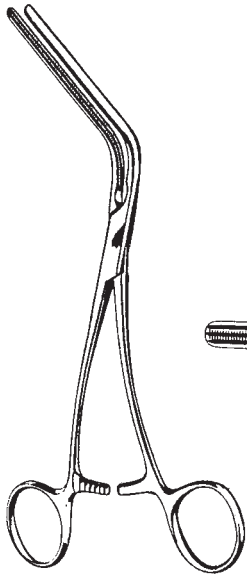

MORRIS-DE BAKHEY  
 61032-18 - 61032-25

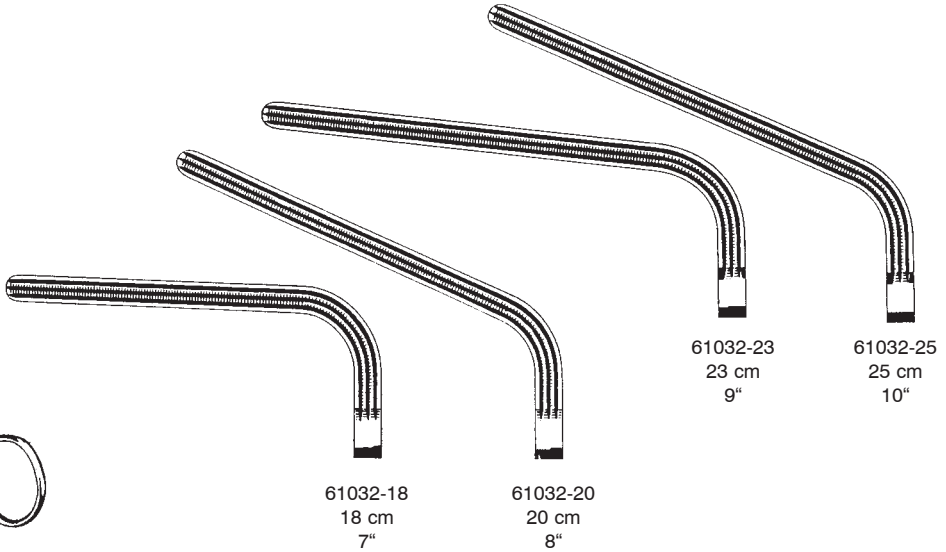

61032-18  
 18 cm  
 7"

61032-20  
 20 cm  
 8"

61032-23  
 23 cm  
 9"

61032-25  
 25 cm  
 10"



61033-23  
 23 cm  
 9"

61033-24  
 24 cm  
 9 1/2"

61033-25  
 25 cm  
 10"

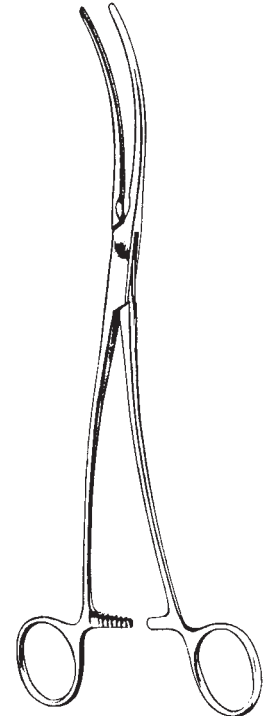

DE BAKHEY-BAHNSON  
 61033-23 - 61033-25

**Atrauma**

Mehrzweck-Gefäßklemme  
 Multi purpose Vascular Clamps  
 Pinzas vasculares de usos multiples  
 Pinze vascolari universali

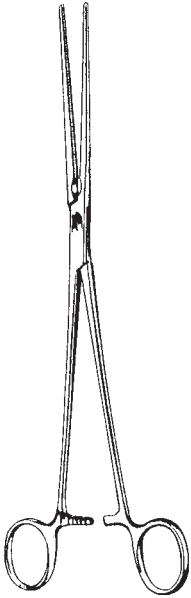

DE BAKEY  
 61034-21 - 61034-31



61034-21  
 21,5 cm  
 8 1/2"



61034-23  
 23 cm  
 9"



61034-27  
 27 cm  
 10 1/2"



61034-31  
 31,5 cm  
 12 1/2"

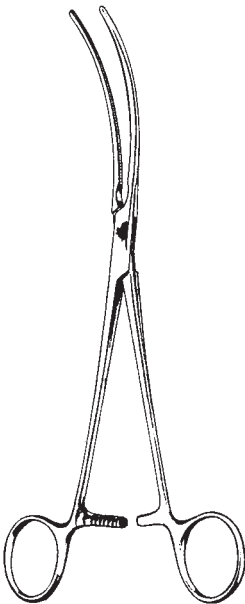

DE BAKEY  
 61035-21 - 61035-31



61035-21  
 21,5 cm  
 8 1/2"

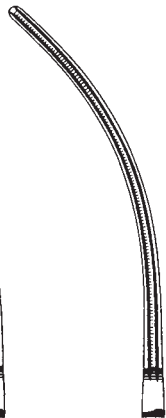

61035-23  
 23 cm  
 9"

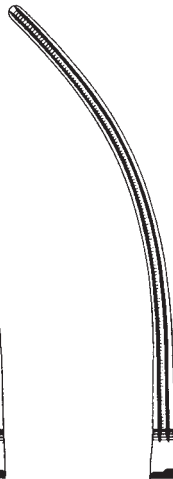

61035-27  
 27 cm  
 10 1/2"

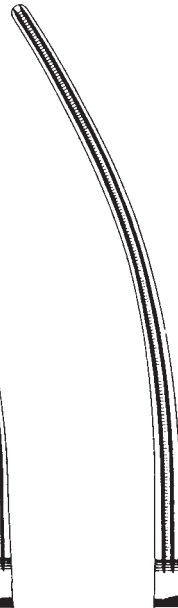

61035-31  
 31 cm  
 12 1/4"

Mehrzweck-Gefäßklemme  
 Multi purpose Vascular Clamps  
 Pinzas vasculares de usos multiples  
 Pinze vascolari universali

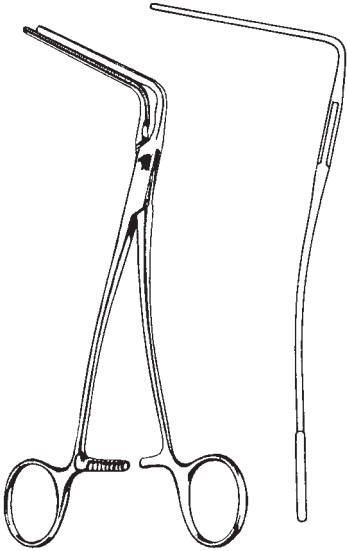

DE BAKEY  
 61036-18 - 61036-27

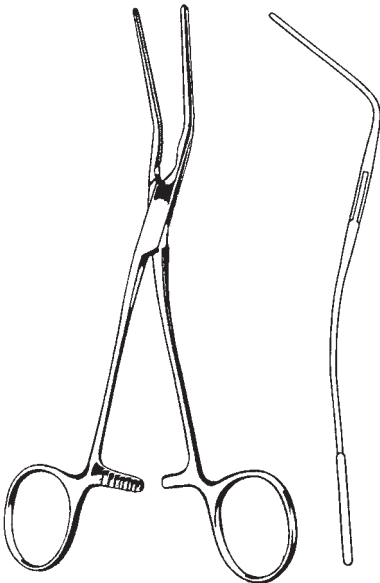
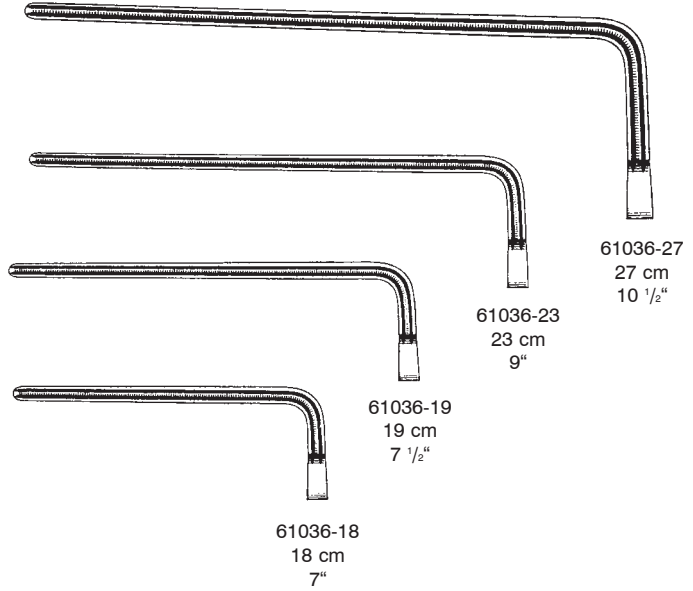

DE BAKEY  
 61037-20 - 61037-29

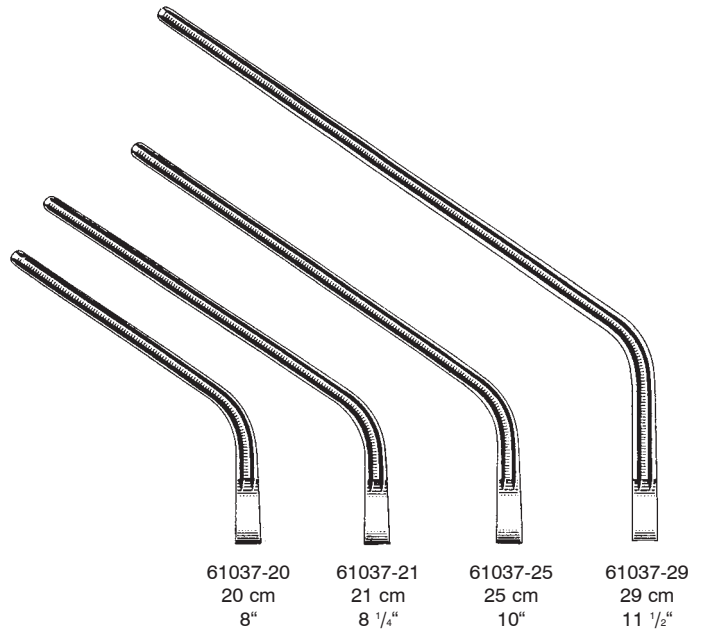

**Atrauma**

Arterienklemmen  
Hemostatic forceps  
Pinzas hemostáticas  
Pinze emostatiche

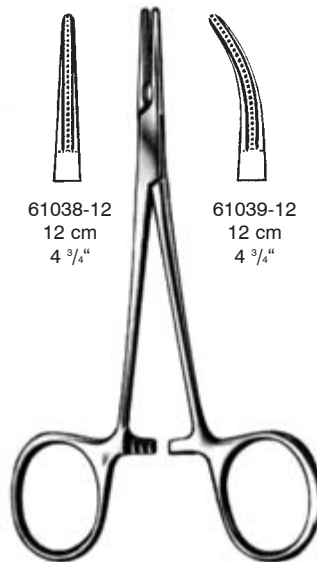

61038-12  
12 cm  
4 <sup>3</sup>/<sub>4</sub>\"/>

61039-12  
12 cm  
4 <sup>3</sup>/<sub>4</sub>\"/>

DE BAKEY-MOSQUITO  
61038-12 - 61039-12

Mehrzweck-Gefäßklemme  
 Multi purpose Vascular Clamps  
 Pinzas vasculares de usos multiples  
 Pinze vascolari universali

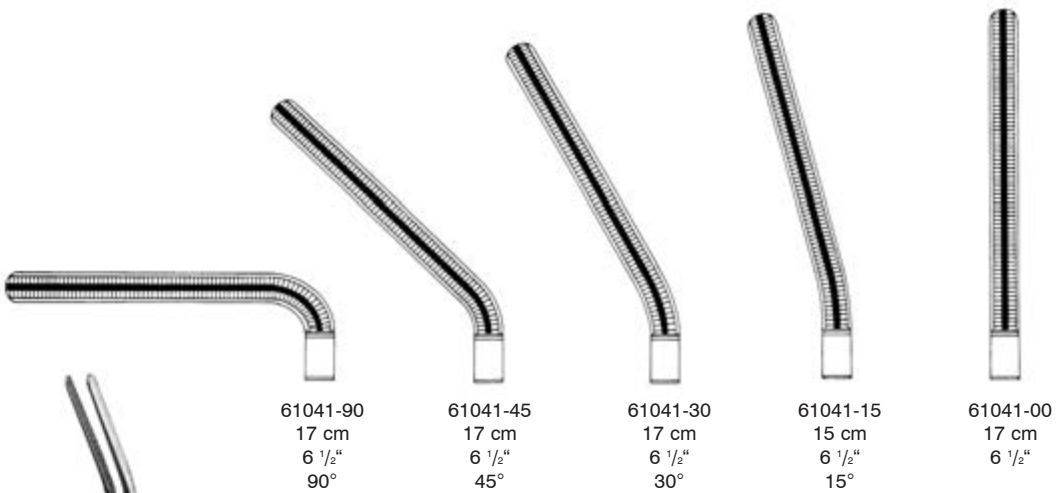
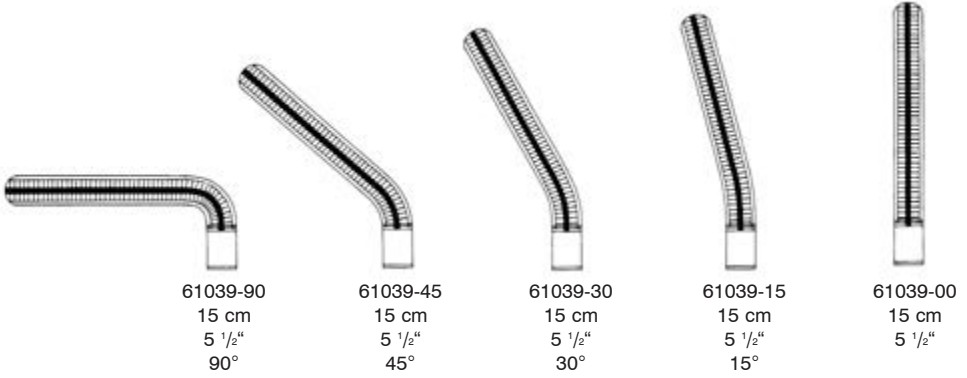

DARDIK





Aortaklemme, Katheterklemme  
 Aortic Clamps, Catheter Clamps  
 Pinzas-clamps para aorta, Pinzas para catéteres  
 Pinze per aorta, Pinze per cateteri

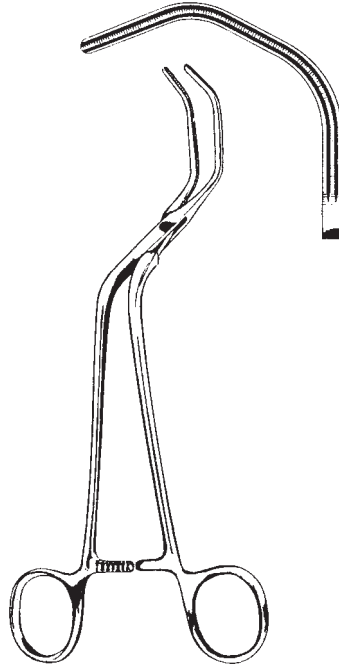

DIETRICH  
 61040-21 21 cm, 8 1/4"

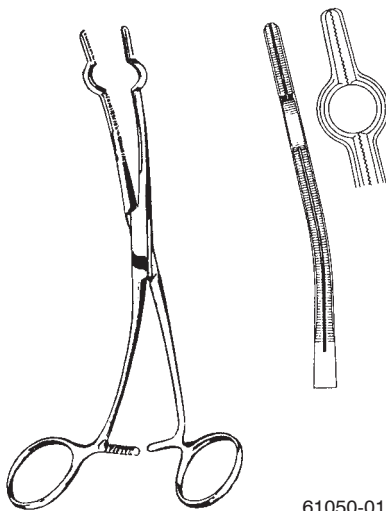

COOLEY  
 61050-01 - 61050-07

Charrière (French)	Länge Length Largo Lungo cm		
24	16	6 1/4"	61050-01
26	16	6 1/4"	61050-02
28	20	8"	61050-03
30	20	8"	61050-04
32	20	8"	61050-05
36	20	8"	61050-07

61050-01 - 61050-02  
 für Kinder  
 for children  
 para niños  
 per bambini

61050-03 - 61050-07  
 für Erwachsene  
 for adults  
 para adultos  
 per adulti

**Atrauma**

Carotis-Shuntklemmen  
Carotid Shunt Clamps  
Pinzas para shunt carótido  
Pinze per carotide



JAVID  
61045-18  
17,5 cm, 6.9"



JAVID  
61046-19  
18 cm, 7"

Arterienklemmen  
Haemostatic Forceps  
Pinzas hemostáticas  
Pinze emostatiche

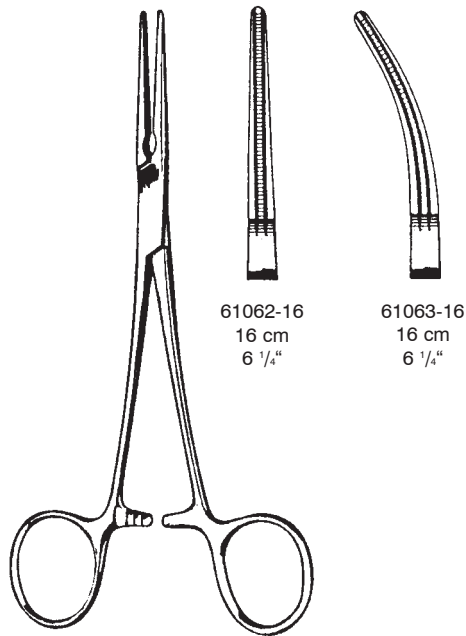

61062-16  
16 cm  
6 1/4"

61063-16  
16 cm  
6 1/4"

DE BAKEY-RANKIN  
61062-16 - 61063-16

# Atrauma

Arterienklemmen  
Haemostatic Forceps  
Pinzas hemostáticas  
Pinze emostatiche

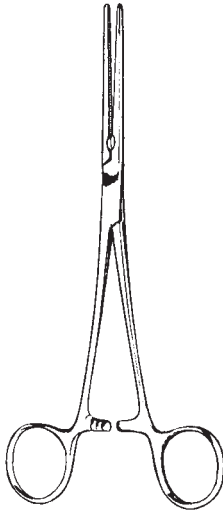

DE BAKEY-PEAN  
61138-14 - 61138-20



61138-14  
14 cm  
5 1/2"



61138-16  
16 cm  
6 1/4"



61138-18  
18 cm  
7"



61138-20  
20 cm  
8"

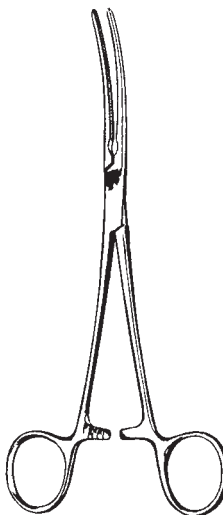

DE BAKEY-PEAN  
61139-14 - 61139-20



61139-14  
14 cm  
5 1/2"



61139-16  
16 cm  
6 1/4"



61139-18  
18 cm  
7"



61139-20  
20 cm  
8"

Mehrzweck-Gefäßklemmen  
 Multi purpose Vascular Clamps  
 Pinzas vasculares de usos múltiples  
 Pinze vascolari universali

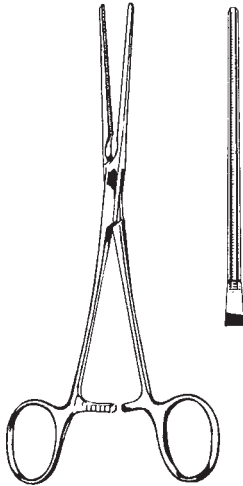

DE BAKEY  
 61140-17  
 17 cm, 6 <sup>3</sup>/<sub>4</sub>"

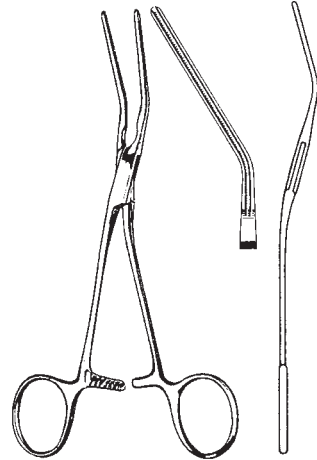

DE BAKEY  
 61141-16  
 16 cm, 6 <sup>1</sup>/<sub>4</sub>"

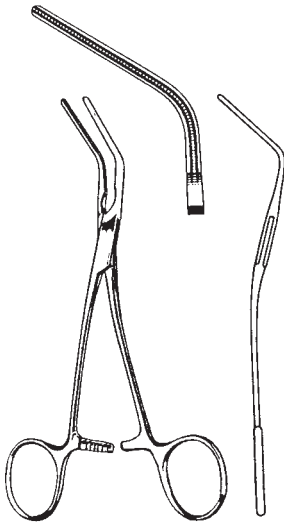

DE BAKEY  
 61143-15  
 15 cm, 6"

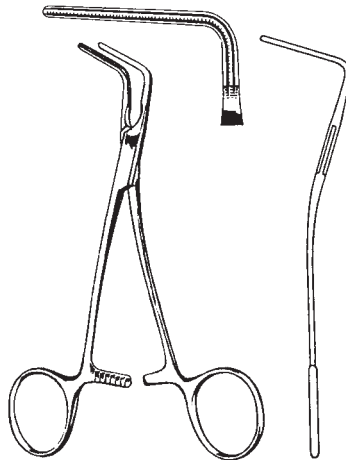

DE BAKEY  
 61145-15  
 15 cm, 6"

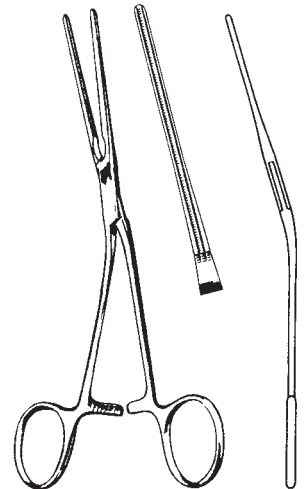

DE BAKEY  
 61147-17  
 17 cm, 6 <sup>3</sup>/<sub>4</sub>"

**Atrauma**

Mehrzweck-Gefäßklemmen, Anastomosenklemmen  
Multi purpose Vascular Clamps, Anastomosis Clamps  
Pinzas vasculares de usos múltiples, Pinzas para anastomosis  
Pinze vascolari universali, Pinze per anastomosi

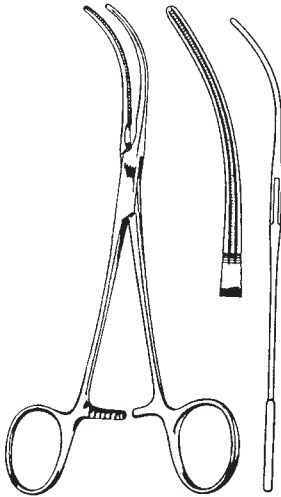

GLOVER  
61149-17  
17 cm, 6 <sup>3</sup>/<sub>4</sub>"

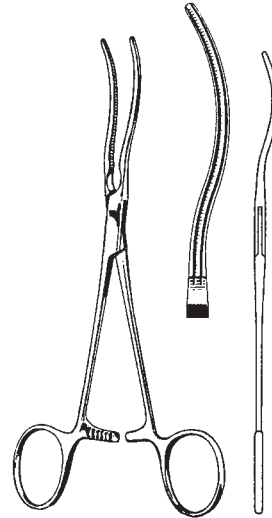

GLOVER  
61151-17  
17 cm, 6 <sup>3</sup>/<sub>4</sub>"

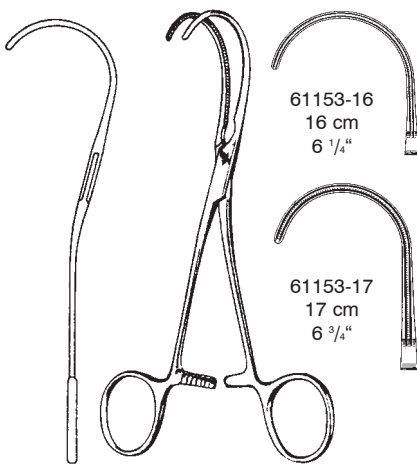

DE BAKEY  
61153-16 - 61153-17

61153-16  
16 cm  
6 <sup>1</sup>/<sub>4</sub>"

61153-17  
17 cm  
6 <sup>3</sup>/<sub>4</sub>"

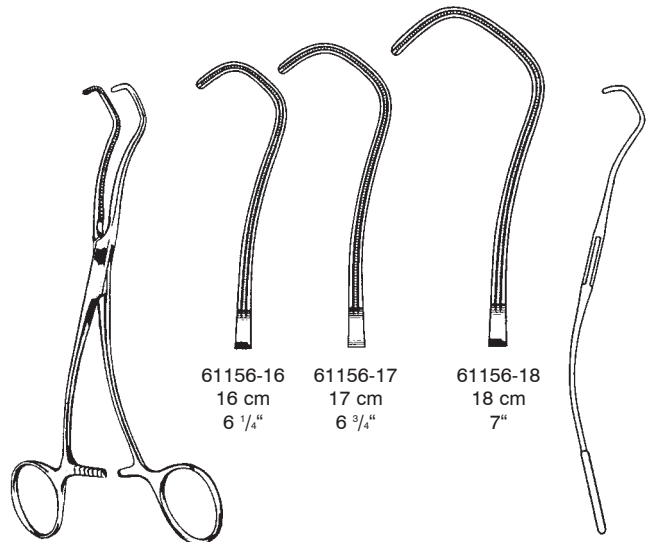

DERRA  
61156-16 - 61156-18

61156-16  
16 cm  
6 <sup>1</sup>/<sub>4</sub>"

61156-17  
17 cm  
6 <sup>3</sup>/<sub>4</sub>"

61156-18  
18 cm  
7"

Anastomosenklemmen, Kinder-Gefäßklemmen  
 Anastomosis Clamps, Pediatric Vascular Clamps  
 Pinzas para anastomosis, Pinzas vasculares pediátricas  
 Pinze per anastomosi, Pinze vascolari pediatriche

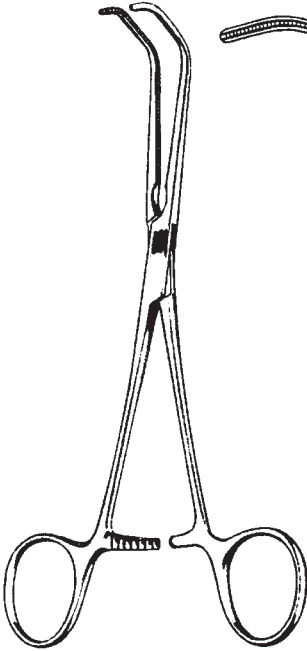

DE BAKEY-BECK  
 61157-17 17 cm, 6  $\frac{3}{4}$ "

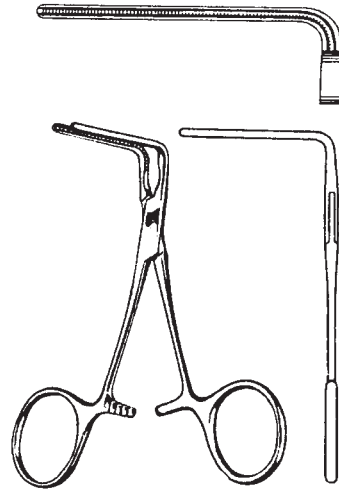

DE BAKEY  
 61158-10 10 cm, 4"

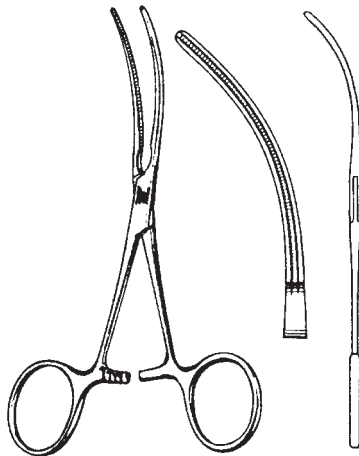

DE BAKEY  
 61158-11 11 cm, 4  $\frac{3}{8}$ "



**Atrauma**

Kinder-Gefäßklemmen, Profundaklemmen  
Pediatric Vascular Clamps, Profunda Clamps  
Pinzas vasculares pediátricas, Pinzas para la profunda  
Pinze vascolari pediatriche, Pinze profunda

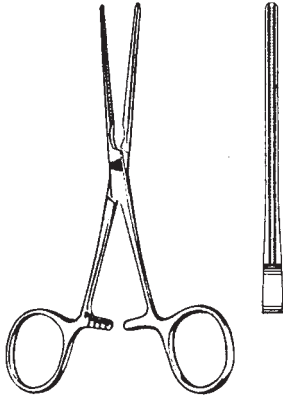

DE BAKEY  
61158-12 12 cm, 4 3/4"

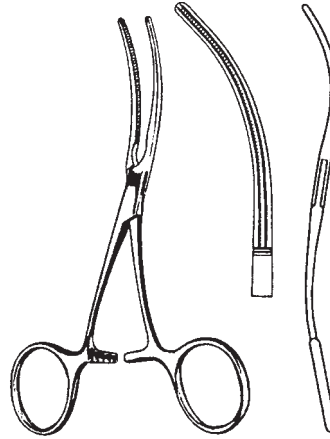

DE BAKEY  
61159-12 11,5 cm, 4 1/2"

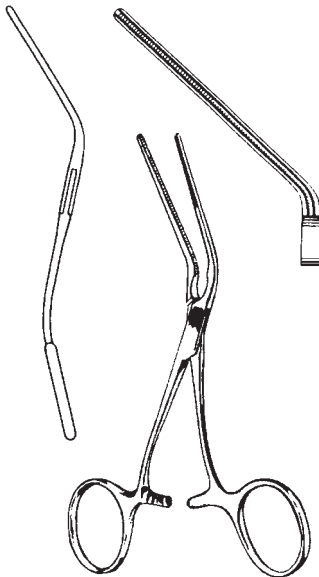

DE BAKEY  
61159-13 13 cm, 5 1/8"

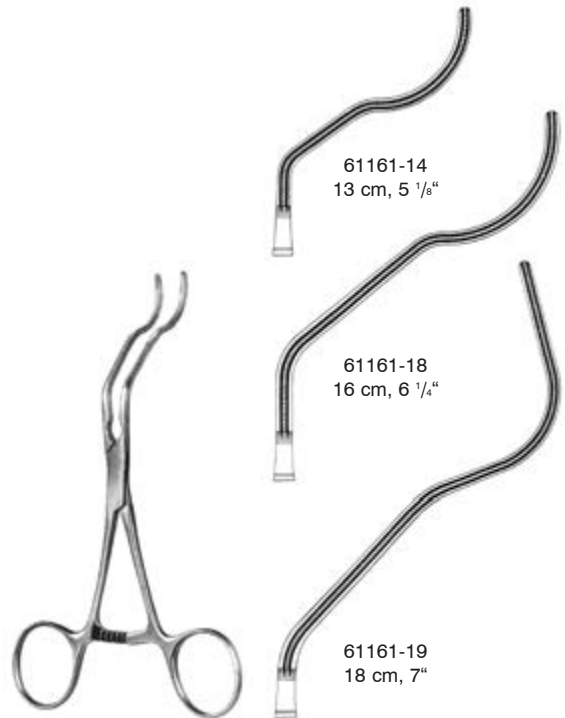

GREGORY

61161-14  
13 cm, 5 1/8"

61161-18  
16 cm, 6 1/4"

61161-19  
18 cm, 7"

Mehrzweck-Gefäßklemmen  
 Multi purpose Vascular Clamps  
 Pinzas vasculares de usos múltiples  
 Pinze vascolari universali

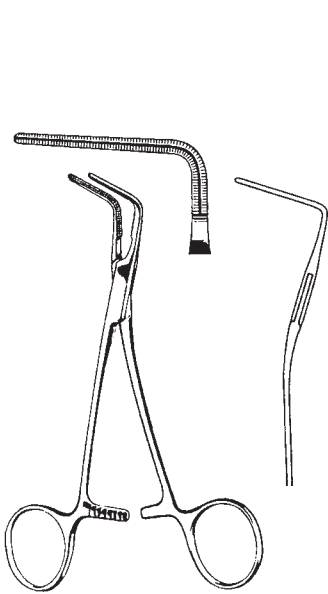

COOLEY  
 61172-15  
 15 cm, 6"

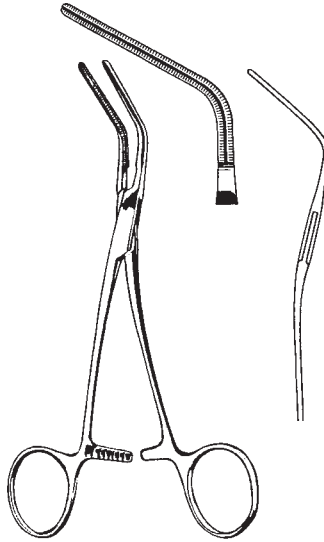

COOLEY  
 61173-16  
 15,5 cm, 6"

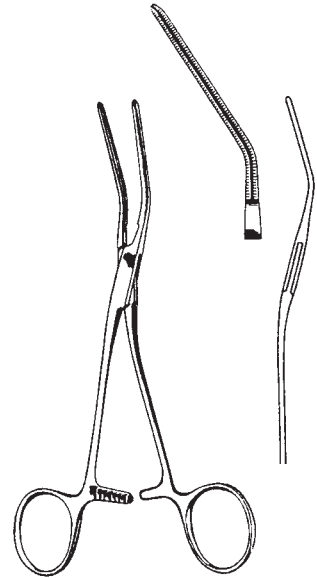

COOLEY  
 61174-17  
 17 cm, 6 3/4"

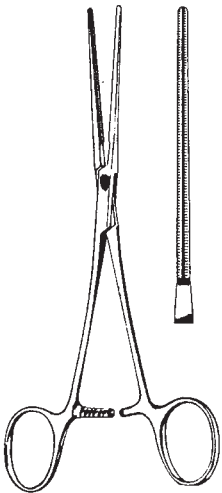

COOLEY  
 61175-17  
 17 cm, 6 3/4"

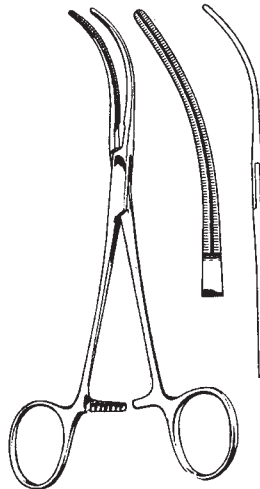

COOLEY  
 61176-17  
 17 cm, 6 3/4"

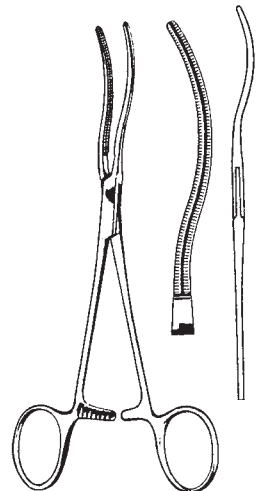

COOLEY  
 61177-17  
 17 cm, 6 3/4"

**Atrauma**

Anastomosenklemmen  
 Anastomosis Clamps  
 Pinzas para anastomosis  
 Pinze per anastomosi



COOLEY-DERRA  
 61178-16 - 61179-18



61178-16  
 16 cm  
 6 1/4"



61178-17  
 17 cm  
 6 3/4"



61179-18  
 18 cm  
 7"



61187-17  
 17 cm  
 6 3/4"

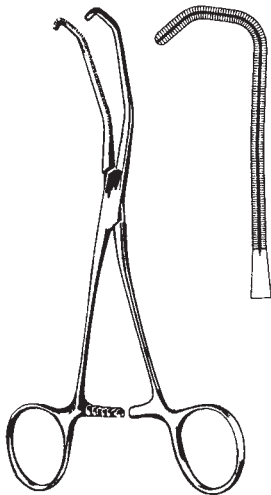

COOLEY  
 61180-17  
 17 cm, 6 3/4"

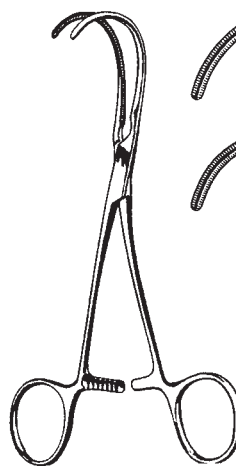

COOLEY  
 61187-16 - 61187-17

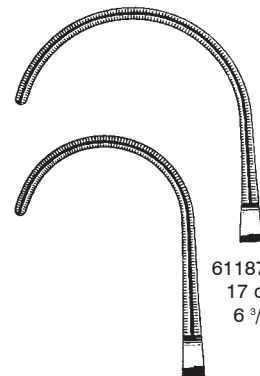

61187-16  
 16 cm  
 6 1/4"

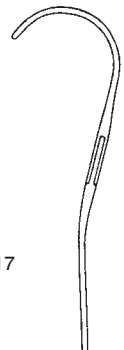

Anastomosenklemmen, Mehrzweck-Gefäßklemme

Anastomosis Clamp, Multi purpose Vascular Clamps

Pinza clamp para iliac y anastomosis, Pinzas vasculares de usos multiples

Pinze anastomosi, Pinze vascolari universali

Carotisklemme  
Carotid Clamp  
Pinza para carótida  
Pinza per carotis



COOLEY  
61188-20 20 cm, 8"

Iliacaklemme  
Iliac Clamp  
Pinza para iliaca  
Pinza iliaca

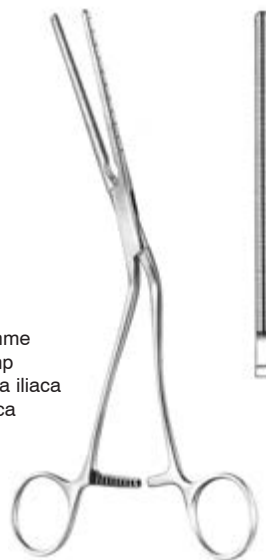

COOLEY  
61189-21 21 cm, 8 1/4"



BECK  
61190-17 17 cm, 6 3/4"



COOLEY  
61191-16 16 cm, 6 1/4"



COOLEY  
61192-17 17 cm, 6 3/4"

**Atrauma**

Anastomosenklemmen  
Anastomosis Clamp  
Pinza clamp para iliac y anastomosis  
Pinze anastomosi

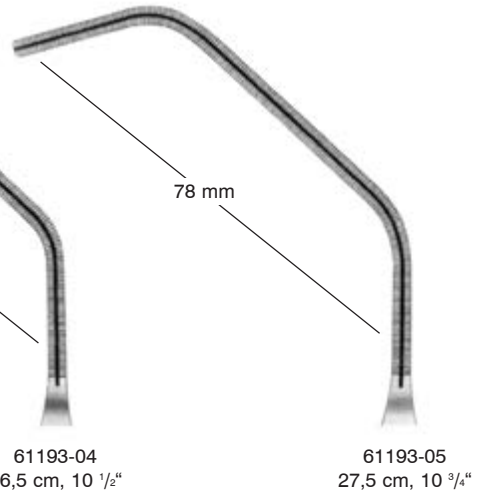
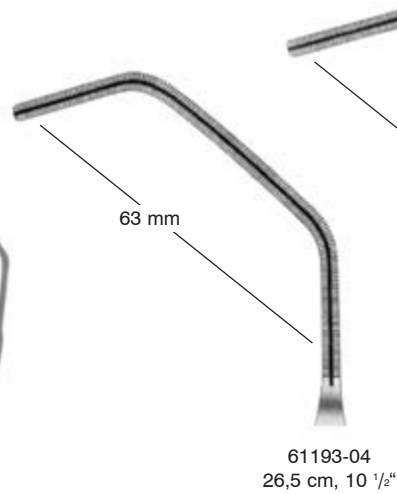
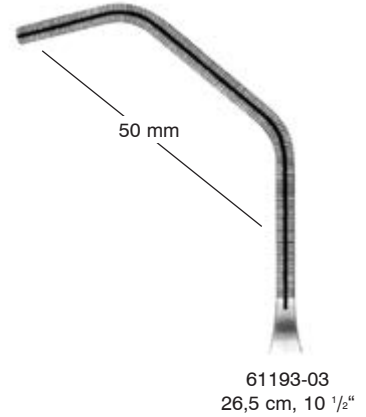
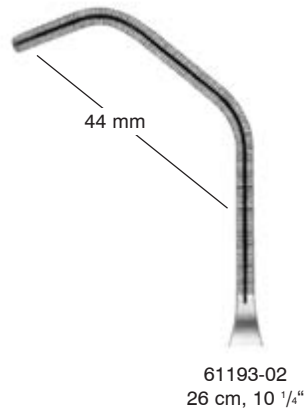
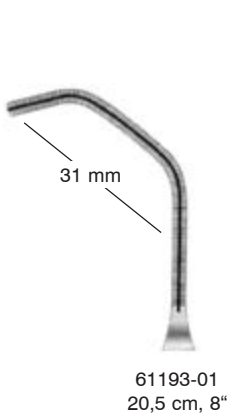

COOLEY

Mehrzweck-Gefäßklemme  
Multi purpose Vascular Clamps  
Pinzas vasculares de usos multiples  
Pinze vascolari universali

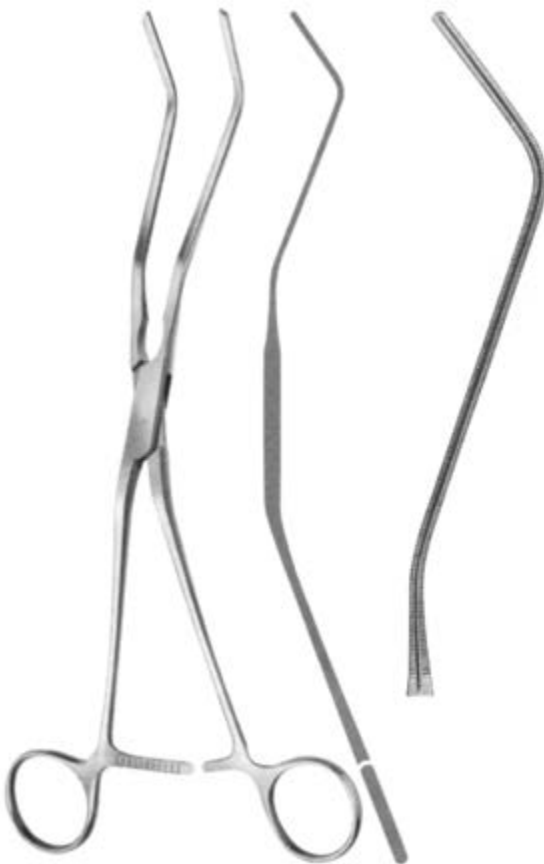

COOLEY  
61194-26 26 cm, 10 <sup>3</sup>/<sub>4</sub>"



COOLEY  
61195-28 28,5 cm, 11 <sup>1</sup>/<sub>4</sub>"

**Atrauma**

Aortaklemme  
Aortic Clamps  
Pinzas aórticas  
Pinze per aorta



COOLEY  
61195-32 32 cm, 12 3/4"

Anastomosenklemmen  
Anastomosis Clamp  
Pinza clamp para iliac y anastomosis  
Pinze anastomosi



COOLEY  
61196-26 26 cm, 10 1/4"



Kinder-Aortaklemme  
Pediatric Aortic Clamps  
Pinza aórticas pediátricas  
Pinze per aorta pediatriche

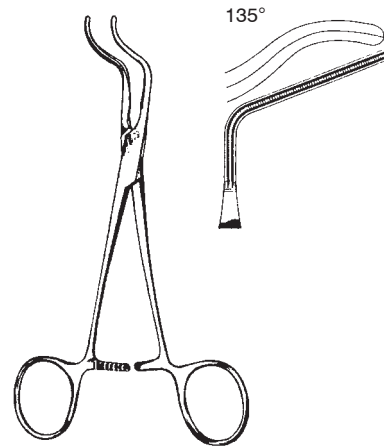

SUBRAMANIAN-MINIATURE  
61259-15 15,5 cm, 6"

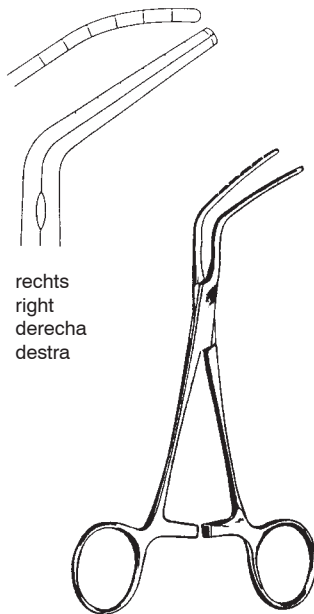

rechts  
right  
derecha  
destra

SUBRAMANIAN  
61261-16 16 cm, 6 1/4"

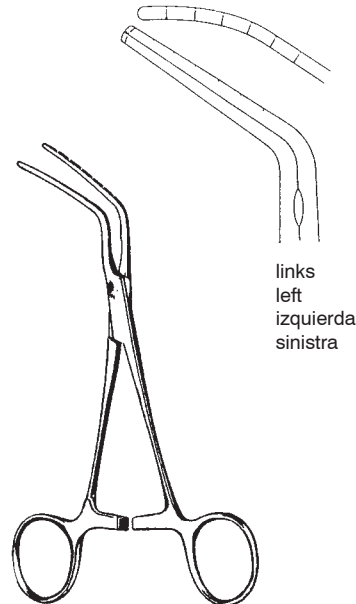

links  
left  
izquierda  
sinistra

SUBRAMANIAN  
61263-16 16 cm, 6 1/4"

Kinder-Gefäßklemmen  
 Pediatric Vascular Clamps  
 Pinzas vasculares pediátricas  
 Pinze vascolari pediatriche

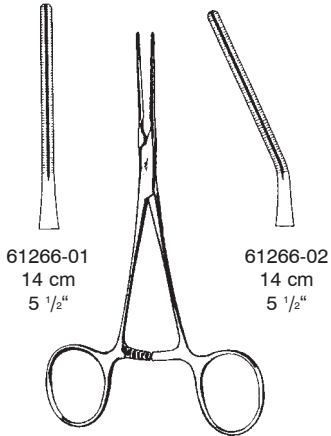

COOLEY  
 61266-01 - 61266-02  
 14 cm, 5 1/2"

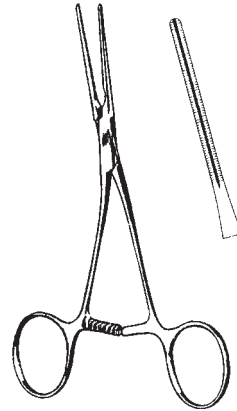

COOLEY  
 61266-03 14 cm, 5 1/2"

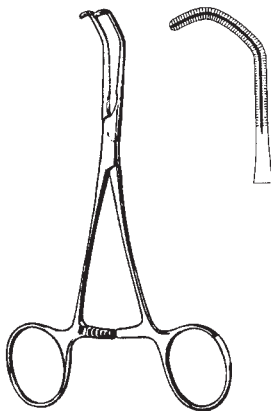

COOLEY  
 61266-04 14 cm, 5 1/2"

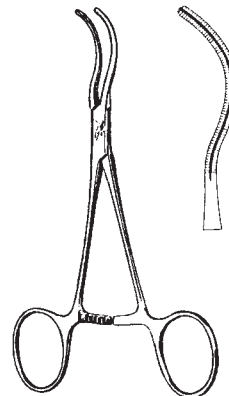

COOLEY  
 61266-05 14 cm, 5 1/2"

**Atrauma**

Kinder-Gefäßklemmen  
 Pediatric Vascular Clamps  
 Pinzas vasculares pediátricas  
 Pinze vascolari pediatriche

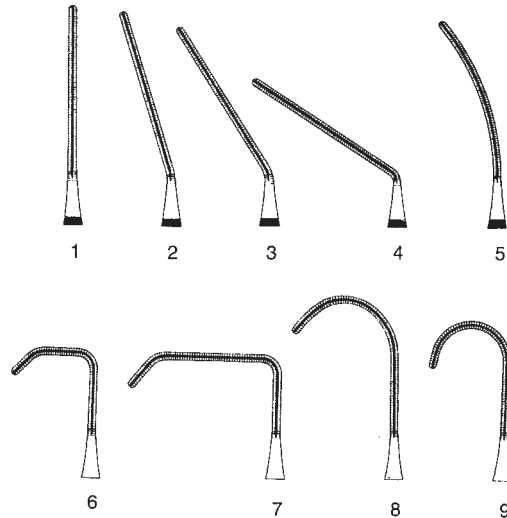
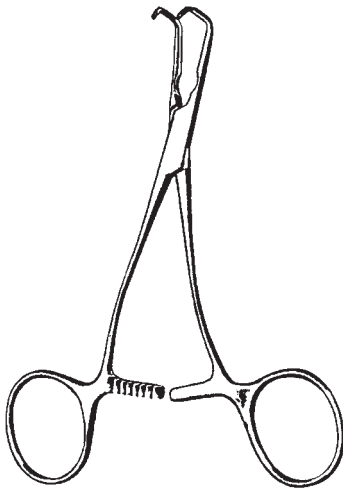

Fig.	gerade straight rectas rette
1	61372-01 14 cm, 5 1/2"
2	61372-02 14 cm, 5 1/2"
3	61372-03 14 cm, 5 1/2"
4	61372-04 13 cm, 5 1/8"
5	61372-05 14 cm, 5 1/2"
6	61372-06 13 cm, 5 1/8"
7	61372-07 13 cm, 5 1/8"
8	61372-08 14 cm, 5 1/2"
9	61372-09 13,5 cm, 5 1/4"



Fig.	stark abgewinkelt strongly angled ramas anguladas forte angolata
1	61373-01 14 cm, 5 1/2"
2	61373-02 14 cm, 5 1/2"
3	61373-03 14 cm, 5 1/2"
4	61373-04 13 cm, 5 1/8"
5	61373-05 14 cm, 5 1/2"
6	61373-06 13 cm, 5 1/8"
7	61373-07 13 cm, 5 1/8"
8	61373-08 14 cm, 5 1/2"
9	61373-09 13,5 cm, 5 1/4"

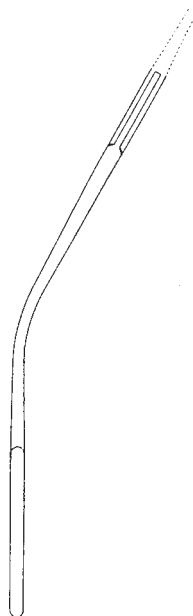

Fig.	abgewinkelt angled acodadas angolate
1	61374-01 14 cm, 5 1/2"
2	61374-02 14 cm, 5 1/2"
3	61374-03 14 cm, 5 1/2"
4	61374-04 13 cm, 5 1/8"
5	61374-05 14 cm, 5 1/2"
6	61374-06 13 cm, 5 1/8"
7	61374-07 13 cm, 5 1/8"
8	61374-08 14 cm, 5 1/2"
9	61374-09 13,5 cm, 5 1/4"



Clipanlegezangen für die offene Chirurgie 25° aufgebogen  
 Clip Appliers for open Surgery 25° upcurved  
 Pinza aplicadora de clips para cirugía abierta con ángulo de 25°  
 Pinza applicatore clips per chirurgia aperto, curvo in alto 25°



15 cm, 6"

**Horizon**

61460-15 Small gelb / yellow / jaune/ amarillo/ giallo  
 61461-15 Medium blau / blue / bleu / azul / blu

**SLS Clips**

61464-15 Micro weiss / white / blanc / blanco / bianco  
 61465-15 Small gelb / yellow / jaune/ amarillo/ giallo  
 61466-15 Small medium lila / lilac / lilas / lila / lilla  
 61467-15 Medium blau / blue / bleu / azul / blu

**Ethicon**

61470-15 Small blau / blue / bleu / azul / blu  
 61471-15 Medium weiss / white / blanc / blanco / bianco

**Pilling**

61481-15 Small gelb / yellow / jaune / amarillo / giallo  
 61482-15 Medium blau / blue / bleu / azul / blu

**Horizon**

61460-19 Small gelb / yellow / jaune / amarillo / giallo  
 61461-19 Medium blau / blue / bleu / azul / blu  
 61462-19 Medium Large grün / green / verde / verde  
 61463-19 Large orange / naranja / arancione

**SLS Clips**

61464-19 Micro weiss / white / blanc / blanco / bianco  
 61465-19 Small gelb / yellow/ jaune / amarillo / giallo  
 61466-19 Small medium lila / lilac / lilas / lila / lilla  
 61467-19 Medium blau / blue / bleu / azul / blu  
 61468-19 Medium Large grün / green / verde / verde  
 61469-19 Large orange / naranja / arancione

**Ethicon**

61470-19 Small blau / blue / bleu / azul / blu  
 61471-19 Medium weiss / white / blanc / blanco / bianco  
 61472-19 Medium Large grün / green / verde / verde  
 61473-19 Large gelb / yellow / jaune / amarillo / giallo

**Pilling**

61481-19 Small gelb / yellow / jaune / amarillo / giallo  
 61482-19 Medium blau / blue / bleu / azul / blu  
 61484-19 Medium Large grün / green / verde / verde  
 61483-19 Large orange / naranja / arancione



19 cm, 7 1/2"

Clipanlegezangen für die offene Chirurgie 25° aufgebogen  
Clip Appliers for open Surgery 25° upcurved  
Pinza aplicadora de clips para cirugía abierta con ángulo de 25°  
Pinza applicatore clips per chirurgia aperto, curvo in alto 25°

**Horizon**

61461-28 Medium blau / blue / bleu / azul / blu  
61462-28 Medium Large grün / green / verde / verde  
61463-28 Large orange / naranja / arancione

**SLS Clips**

61464-28 Micro weiss / white / blanco / bianco  
61465-28 Small gelb / yellow / jaune / amarillo / giallo  
61466-28 Small medium lila / lilac / lilas / lila / lilla  
61467-28 Medium blau / blue / bleu / azul / blu  
61468-28 Medium Large grün / green / verde / verde  
61469-28 Large orange / naranja / arancione

**Ethicon**

61471-28 Medium weiss / white / blanco / bianco  
61472-28 Medium Large grün / green / verde / verde  
61473-28 Large gelb / yellow / jaune / amarillo / giallo

**Pilling**

61482-28 Medium blau / blue / bleu / azul / blu  
61484-28 Medium Large grün / green / verde / verde  
61483-28 Large orange / naranja / arancione



28 cm, 11"

Kinder-Gefäßklemmen  
 Pediatric Vascular Clamps  
 Pinzas vasculares pediátricas  
 Pinze vascolari pediatriche

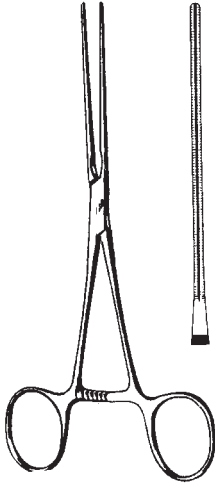

61488-16  
 16,5 cm, 6 1/2"

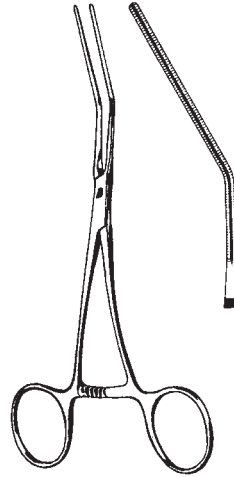

61489-16  
 16 cm, 6 1/4"

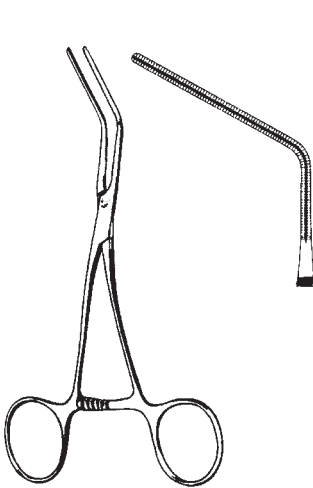

61490-15  
 15 cm, 6"

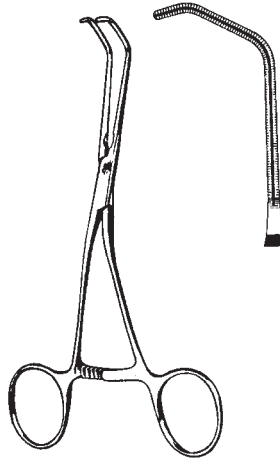

61491-15  
 15 cm, 6"

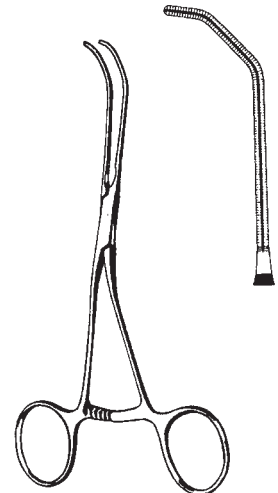

61492-16  
 15,5 cm, 6"

**Atrauma**

Neonatal-Gefäßklemmen  
 Neonatal Vascular Clamps  
 Pinzas vasculares para recién nacidos  
 Pinze vascolari per neonati

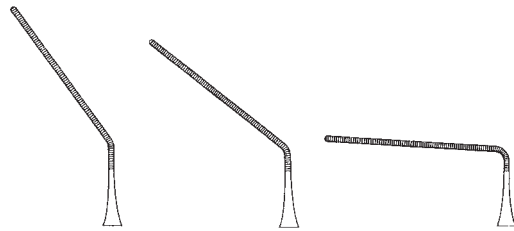

61493-01  
 13 cm  
 5 1/8"

61493-02  
 13 cm  
 5 1/8"

61493-03  
 11 cm  
 4 3/8"

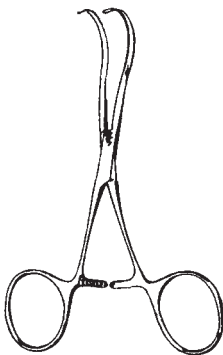

CASTANEDA  
 61493-01 - 61495-04

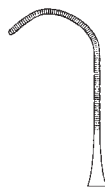

61495-01  
 12 cm  
 4 3/4"

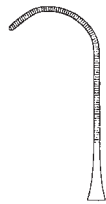

61495-02  
 12 cm  
 4 3/4"



61495-03  
 12 cm  
 4 3/4"



61495-04  
 12 cm  
 4 3/4"

Aortenstanzen, Tourniquets  
 Aorta punches, Tourniquets  
 Trefina para aorta, Tourniquets  
 Trefino per Aorta, Tornichetti

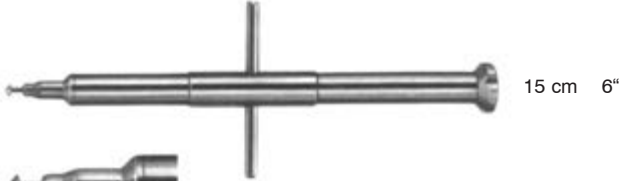

15 cm 6"



61715-04 Ø 4 mm



61715-05 Ø 5 mm



61715-06 Ø 6 mm



61700-01  
 61710-01  
 Mandrin alleine  
 Guide only  
 Guida sola



RUMEL-BELMONT  
 61700-33 3,2 mm Ø  
 61710-33 6,4 mm Ø  
 33 cm, 13"  
 flexibel, flexible,  
 flexible, flessibile



Gefäß-Dilatatoren  
 Vascular Dilators  
 Dilatadores vasculares  
 Dilatatori vascolari

biegsam  
 malleable  
 malleables  
 malleabile

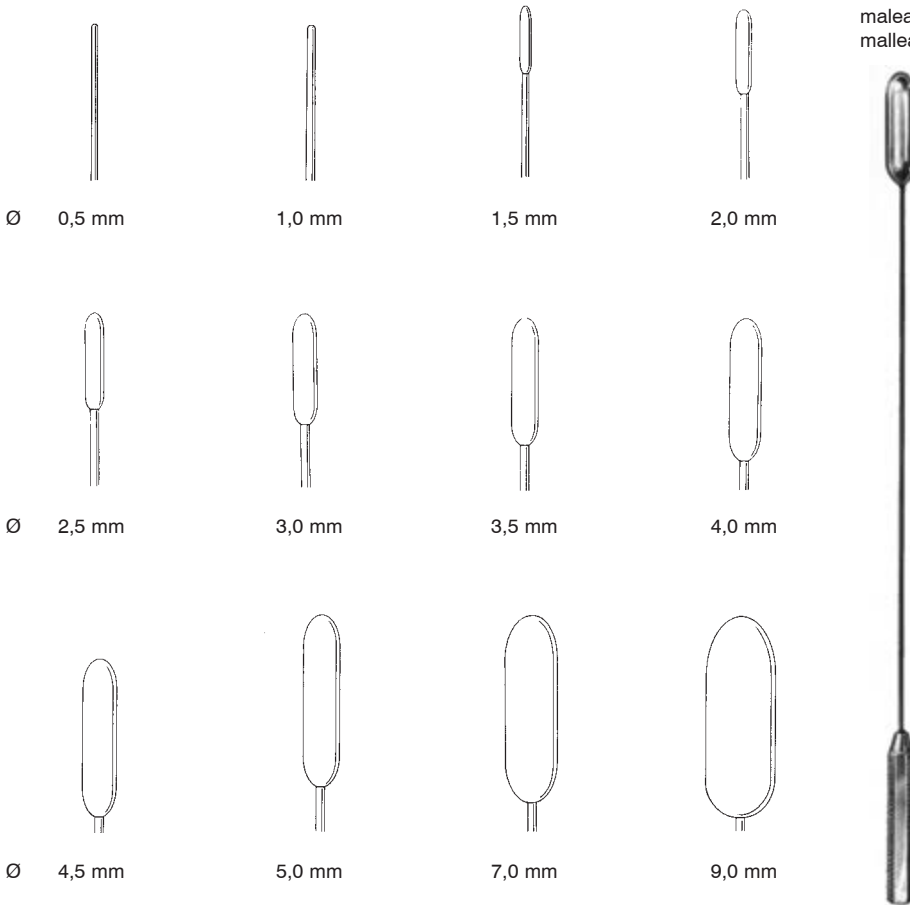

DE BAKEY

19 cm, 7 1/2"	Ø mm	35 cm, 13 3/4"
61810-05	0,5	61820-05
61810-10	1,0	61820-10
61810-15	1,5	61820-15
61810-20	2,0	61820-20
61810-25	2,5	61820-25
61810-30	3,0	61820-30
61810-35	3,5	61820-35
61810-40	4,0	61820-40
61810-45	4,5	61820-45
61810-50	5,0	61820-50
61810-70	7,0	61820-70
61810-90	9,0	61820-90

Gefäßdissektoren  
 Vascular Dissectors  
 Disecadores vasculares  
 Dissettori vascolari

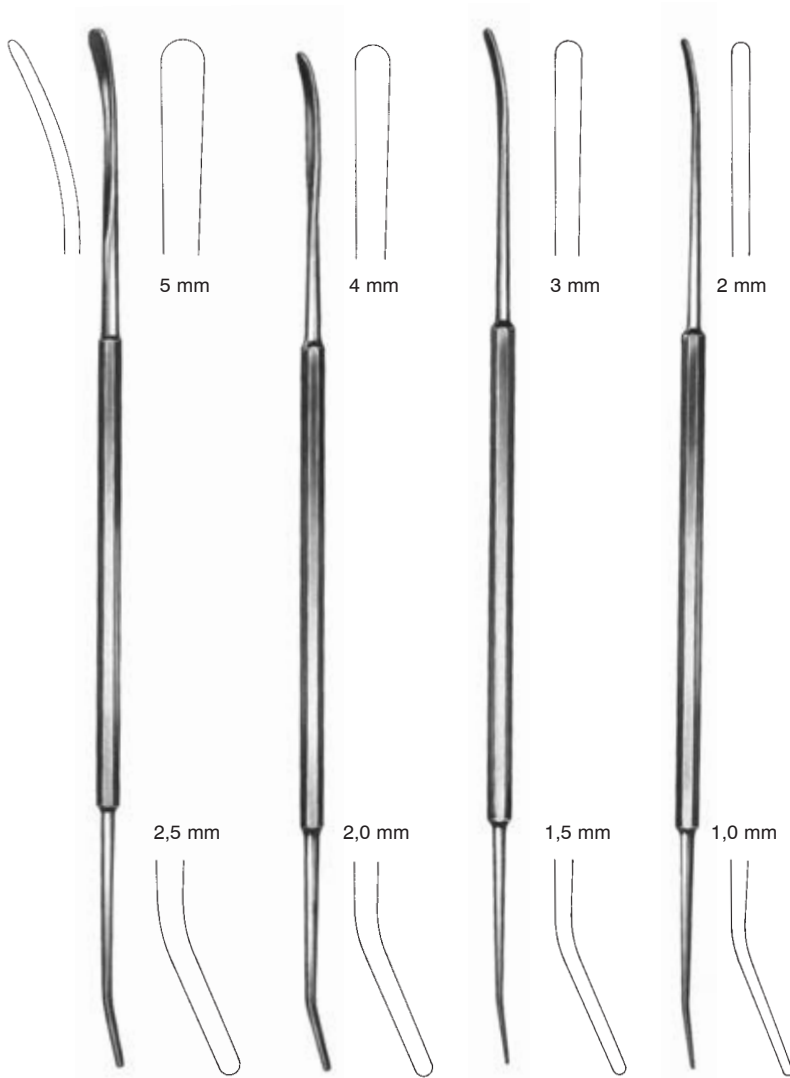

ROBB  
 24 cm, 9 1/2"

Fig. 1  
 61910-01

Fig. 2  
 61910-02

Fig. 3  
 61910-03

Fig. 4  
 61910-04

Intimaspatel  
Intima Spatulas  
Espátulas para la intima  
Spatole per intima



stumpf  
blunt  
roma  
smussa



61920-14  
14 cm 5 1/2"



61920-23  
23,5 cm 9 1/4"



61930-18  
18,5 cm, 7 1/4"

61930-21  
21,5 cm, 8 1/2"

stumpf  
blunt  
roma  
smussa



3 mm



Gallensteinzangen  
 Gall Stone Forceps  
 Pinzas para cálculos biliares  
 Pinze per calcoli biliari



DESJARDINS  
 23 cm, 9"

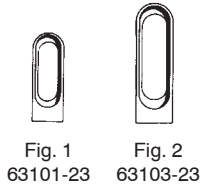
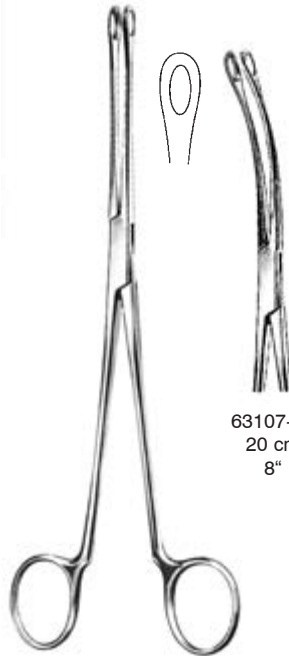

Fig. 1  
 63101-23

Fig. 2  
 63103-23



BLAKE  
 63106-20 20 cm, 8"



63107-20  
 20 cm  
 8"



MAYO-BLAKE  
 63110-20 20 cm, 8"



MAYO-BLAKE  
 63111-20 20 cm, 8"



MIXTER  
 63117-22 22 cm, 8 3/4"

Gallensteinsonden, Gallengangdilatoren  
 Gall Stone Probes, Bile duct dilators  
 Exploradores para cálculos biliares, Dilatadores para conductos biliares  
 Sonde per calcoli biliari, Dilatatori per condotti biliari



Ø 5,8 cm

Gallensteinlöffel  
 Gall Stone Scoops  
 Cucharillas para cálculos biliares  
 Cucchiari per calcoli biliari

MOOR  
 63125-28  
 28 cm, 11"

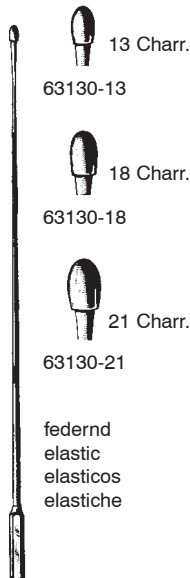

13 Charr.  
 63130-13

18 Charr.  
 63130-18

21 Charr.  
 63130-21

federnd  
 elastic  
 elasticos  
 elastiche

DESJARDINS  
 63130-13 - 63130-21  
 28 cm, 11"

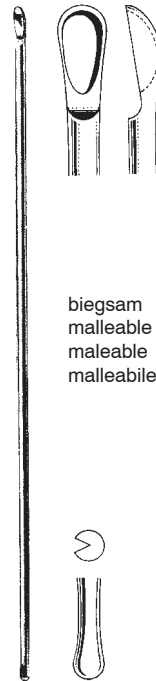

biegsam  
 malleable  
 maleable  
 malleabile

MOYNIHAN  
 63142-34 34 cm, 13 1/2"

Gallensteinsonden, Gallengangdilatoren

Gall Stone Probes, Bile duct dilators

Exploradores para cálculos biliares, Dilatadores para conductos biliares

Sonde per calcoli biliari, Dilatatori per condotti biliari

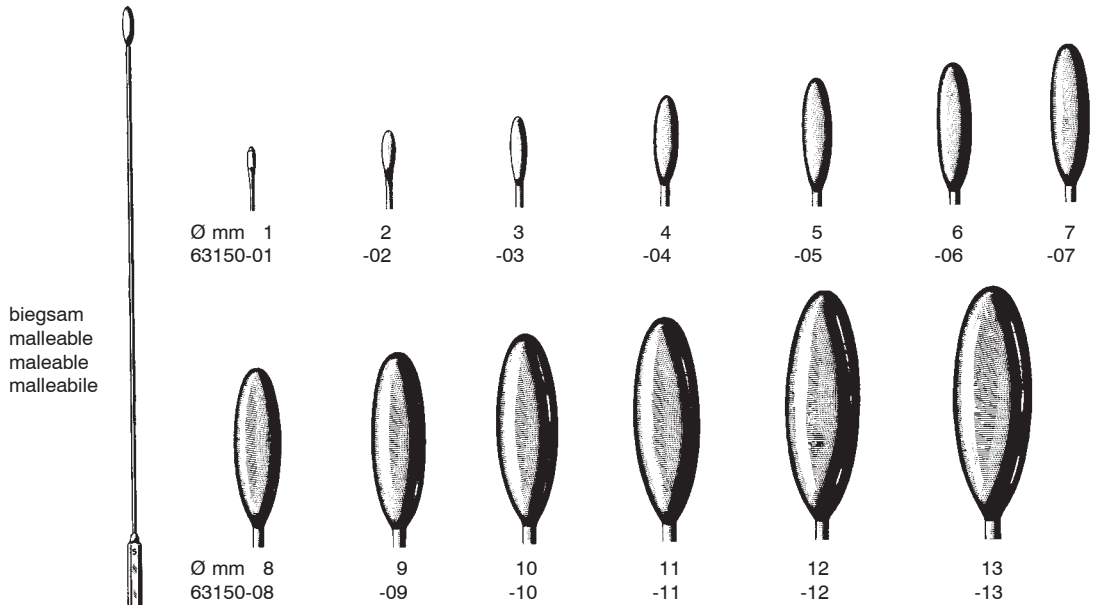

BAKES

63150-01 - 63150-13  
30 cm, 11 3/4"

63150-00 = Satz à 9 St. / set of 9 size 3 to 11  
juego de 9 fig. 3-11 / serie di 9 pezzi

Gallensteinlöffel  
 Gall Stone Scoops  
 Cucharillas para cálculos biliares  
 Cucchiari per calcoli biliari

biegsam  
 malleable  
 maleables  
 malleabile



LUER-KOERTE  
 63173-01 - 63173-08  
 32 cm, 12 3/4"

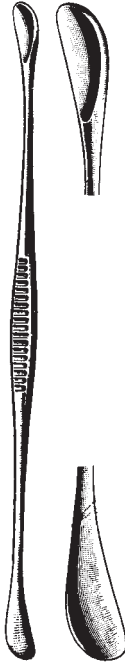

FERGUSSON  
 63170-21 - 63170-23

8,5 mm

11,5 mm

12,5 mm

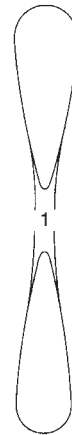

1



2

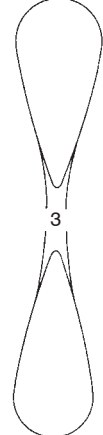

3

10,5 mm

12,5 mm

13,0 mm

63170-21  
 24 cm  
 9 1/2"

63170-22  
 24 cm  
 9 1/2"

63170-23  
 24 cm  
 9 1/2"



2,5 mm



3,2 mm



3,6 mm



5,5 mm

Fig. 000  
 63173-01

Fig. 00  
 63173-02

Fig. 0  
 63173-03

Fig. 1  
 63173-04



6,7 mm



8,0 mm



11 mm



15 mm

Fig. 2  
 63173-05

Fig. 3  
 63173-06

Fig. 4  
 63173-07

Fig. 5  
 63173-08

Gallensteinlöffel, Gallengangsonde  
 Gall Stone Scoops, Gall Duct Probes  
 Cucharillas para cálculos biliares, sonda para conducto biliar  
 Cucchiari per calcoli biliari, sonda per bile



MAYO  
 63175-27  
 27 cm, 10 1/2"



63178-01  
 klein, small, pequeña, piccola



63178-03  
 groß, large, grande

MAYO  
 63178-01 - 63178-03  
 27 cm, 10 1/2"



17 Charr.

Fig. 1  
 63180-17



21 Charr.

Fig. 2  
 63180-21



24 Charr.

Fig. 3  
 63180-24



27 Charr.

Fig. 4  
 63180-27

federnd  
 elastic  
 elásticas  
 elastiche

DESJARDINS  
 63180-17 - 63180-27  
 30 cm, 11 3/4"



biegsam  
 malleable  
 malleabile

MAYO  
 63210-32  
 32 cm, 12 3/4"



Nierensteinzange  
Kidney Stone Forceps  
Pinzas para cálculos renales,  
Pinze per calcoli renali



Fig. 1  
63231-01 23 cm, 9"



Fig. 2  
63231-02 22 cm, 8 3/4"



Fig. 3  
63231-03 22 cm, 8 3/4"



Fig. 4  
63231-04 22 cm, 8 3/4"



RANDALL

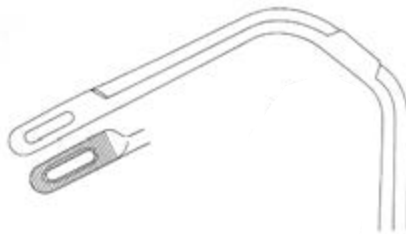

Fig. 5  
63231-05 19 cm, 7 1/2"



Fig. 6  
63231-06 19 cm, 7 1/2"

Nierensteinzange  
Kidney Stone Forceps  
Pinzas para cálculos renales  
Pinze per calcoli renali



HEIMING

für Kinder  
for children  
para niños  
per bambini



63232-01  
17 cm, 6 <sup>3</sup>/<sub>4</sub>"



63232-02  
16 cm, 6 <sup>1</sup>/<sub>4</sub>"

Darm- und Gewebefasszangen  
 Intestinal and Tissue Grasping Forceps  
 Pinzas para intestinos y tejidos  
 Pinze per afferrare intestino e tessuti



**ALLIS-BABY**  
 65102-12 12 cm, 4 3/4"  
 65102-14 14 cm, 5 1/2"

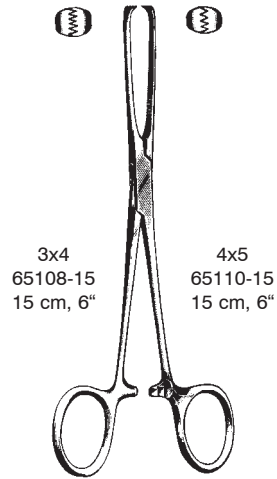

**3x4**  
 65108-15 15 cm, 6"  
**4x5**  
 65110-15 15 cm, 6"

**ALLIS 5x6**  
 65120-15 15 cm, 6"  
 65120-19 19 cm, 7 1/2"  
 65120-22 22 cm, 8 3/4"  
 65120-24 24 cm, 9 1/2"



**ALLIS Atrauma**  
 65124-16 16 cm, 6 1/4"  
 65124-20 20 cm, 8"  
 65124-22 22 cm, 8 3/4"  
 65124-25 25 cm, 10"  
 65124-30 30 cm, 11 3/4"

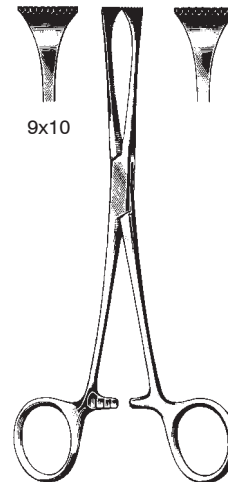

**ALLIS-ADAIR**  
 65130-15 15,5 cm, 6"

Darm- und Gewebefasszangen  
 Intestinal and Tissue Grasping Forceps  
 Pinzas para intestinos y tejidos  
 Pinze per afferrare intestino e tessuti



LOCKWOOD-ALLIS  
 65132-16 16 cm, 6 1/4"  
 65132-20 20 cm, 8"

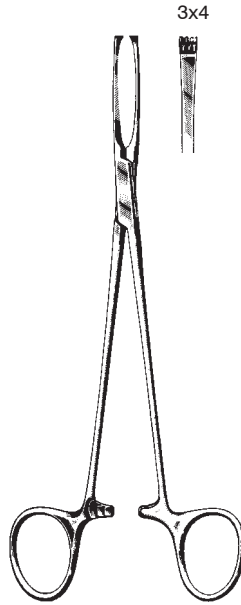

JUDD-ALLIS  
 65140-15 15 cm, 6"  
 65140-19 19 cm, 7 1/2"



BOYS-ALLIS  
 65145-15 15 cm, 6"

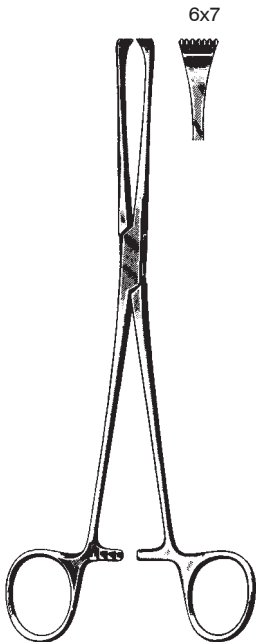

THOMS-ALLIS  
 65150-20 20 cm, 8"



LITTLEWOOD  
 65154-18 18,5 cm, 7 1/4"



GREGOIRE  
 65155-18 18 cm, 7"  
 65155-20 20 cm, 8"

Darm- und Gewebefasszangen  
 Intestinal and Tissue Grasping Forceps  
 Pinzas para intestinos y tejidos  
 Pinze per afferrare intestino e tessuti

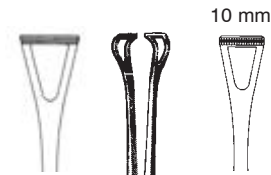

10 mm

**Atrauma**

65168-16 16 cm, 6 1/4"  
 65168-20 20 cm, 8"

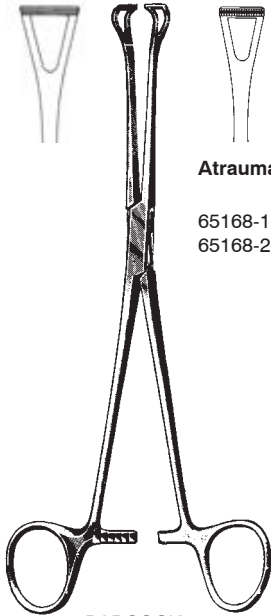

**BABCOCK**

65160-14 14 cm, 5 1/2"  
 65160-16 16 cm, 6 1/4" **65164-16 TC 16 cm**  
 65160-18 18 cm, 7"  
 65160-20 20 cm, 8" **65164-20 TC 20 cm**  
 65160-24 24 cm, 9 1/2"

13 mm

25 mm



**DUVAL**

65170-18 - 65172-23

	cm	
65170-18	18	7"
65170-20	20	8"
<b>65174-20 TC</b>	20	8"
	23	9"
		65172-20
		65172-23

**Atrauma**

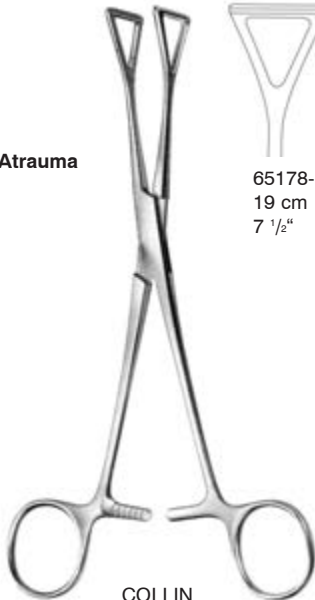

**COLLIN**

21 mm



65178-19  
 19 cm  
 7 1/2"

23 mm



65178-23  
 23 cm  
 9"



**WILLIAMS**

65180-16 16,5 cm, 6 1/2"

Darmklemmen  
 Intestinal Forceps  
 Pinzas intestinales  
 Pinze intestinali

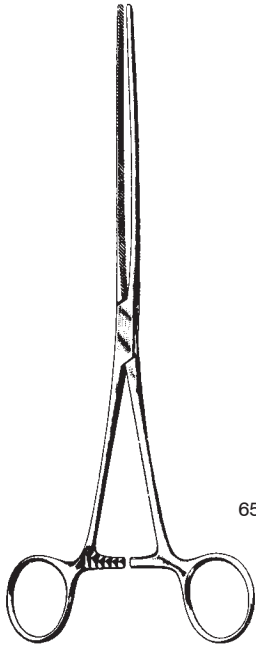

**DOYEN-BABY**  
 65210-18 65211-18  
 18 cm, 7"

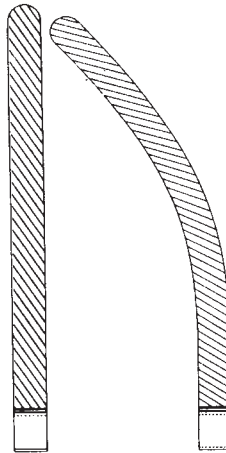
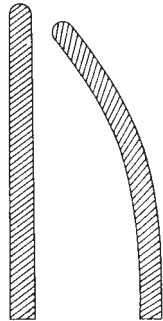

**DOYEN**  
 65210-21 21 cm, 8 1/4" 65211-21  
 65210-23 23 cm, 9" 65211-23

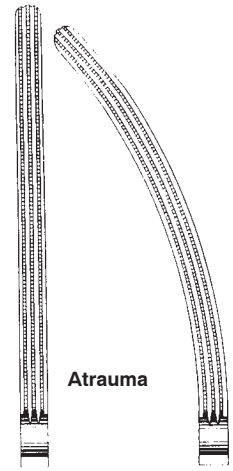

**Atrauma**  
**DOYEN**  
 65216-13 13 cm, 5 1/8" 65217-13  
 65216-16 16 cm, 6 1/4" 65217-16  
 65216-18 18 cm, 7" 65217-18  
 65216-21 21 cm, 8 1/4" 65217-21  
 65216-23 23 cm, 9" 65217-23

**DOYEN**  
 65210-18 - 65217-23

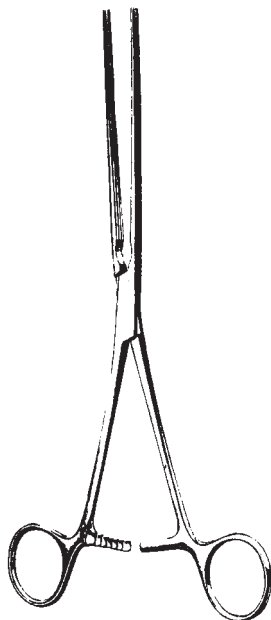

**KOCHER**  
 65220-22 - 65227-28

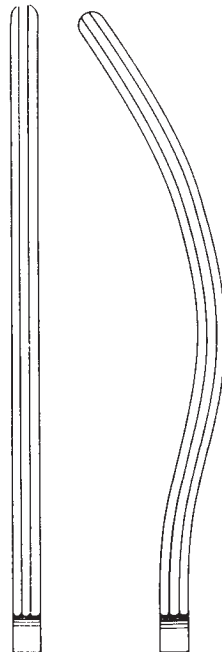

65220-13 13 cm, 5 1/8" 65221-13 **BABY-KOCHER**  
 65220-22 22 cm, 8 3/4" 65221-22  
 65220-25 25 cm, 10" 65221-25  
 65220-28 28 cm, 11" 65221-28

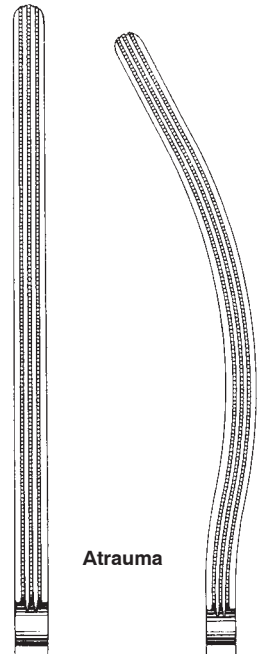

**Atrauma**  
 65226-22 22 cm, 8 3/4" 65227-22  
 65226-25 25 cm, 10" 65227-25  
 65226-28 28 cm, 11" 65227-28

Darmklemmen  
 Intestinal Forceps  
 Pinzas intestinales  
 Pinze intestinali

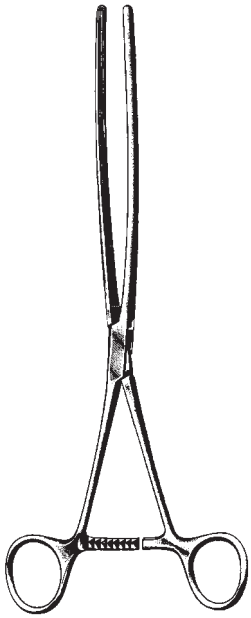

MAYO-ROBSON

65230-21 21 cm, 8 1/4"  
 65237-25 25 cm, 10"

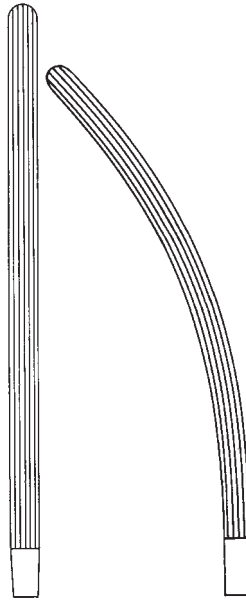

65230-21 21 cm, 8 1/4" 65231-21  
 65230-23 23 cm, 9" 65231-23  
 65230-25 25 cm, 10" 65231-25

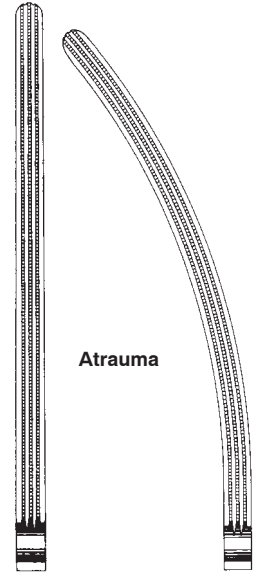

Atrauma

65236-25 25 cm, 10" 65237-25



SCUDDER  
 65238-33  
 33 cm, 13"



Atrauma



65239-33  
 33 cm, 13"

Darmklemmen  
Intestinal Forceps  
Pinzas intestinales  
Pinze intestinali



FEHLAND  
65241-23  
23,5 cm 9 1/4"



Atrauma

RESANO  
65242-30  
30 cm, 11 3/4"



Magen-Darmklemmen  
Intestinal and Stomach Clamps  
Pinzas-clamps intestinales y estomacales  
Pinze intestinali e stomacali

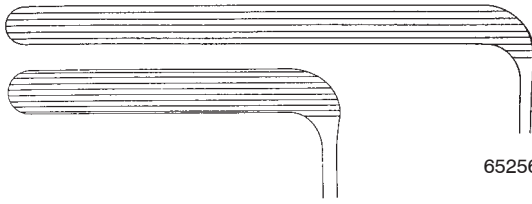

65255-19

65256-19

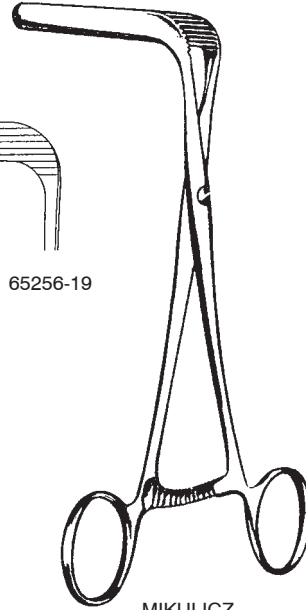

MIKULICZ  
19 cm, 7 1/2"



BRUNNER  
24 cm, 9 1/2"

Atrauma



65259-24

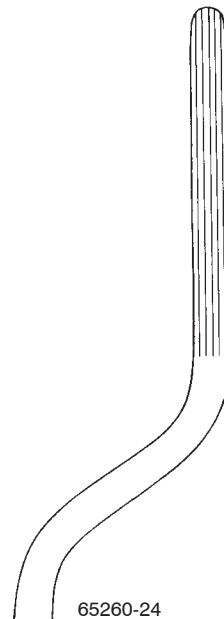

65260-24

Pylorusspreizer, Blinddarmklemmen  
 Pylorus spreader, Blindgut forceps  
 Separador para píloro, Pinzas para apéndice  
 Divaricatori per piloro, Pinza per appendice



BENSON  
 65261-15  
 15,5 cm, 6"



KLEINSCHMIDT  
 65262-12  
 12 cm, 4 <sup>3</sup>/<sub>4</sub>"

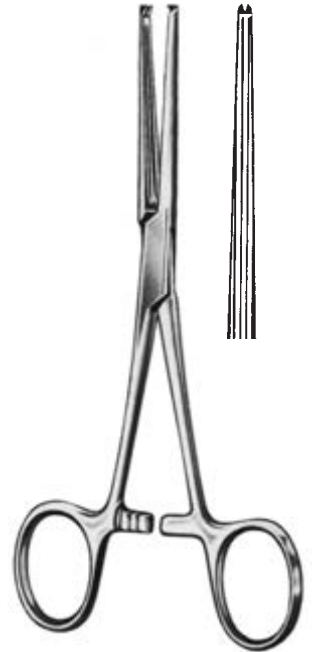

ALLEN  
 65263-15 15 cm, 6"  
 65263-20 20 cm, 8"

Darm-Anastomosenklemmen  
 Intestinal Anastomosis Clamps  
 Clamps para anastomosis intestinales  
 Pinze per anastomosi intestinali



**HAYES**  
 65265-26 26 cm, 10 1/4"  
 65265-28 28 cm, 11"

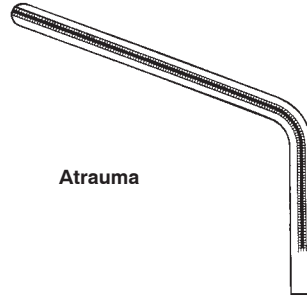

**Atrauma**

65265-26  
 26 cm, 10 1/4"

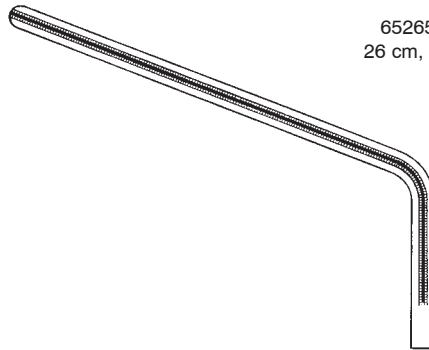

65265-28  
 28 cm, 11"

Schließklemme  
 Closing Forceps  
 Pinza para cerrar clamps  
 Serrapinze e portapinze

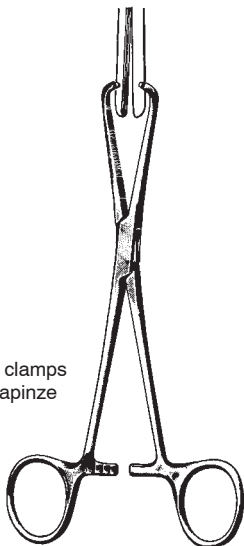

**STONE-WATT**  
 65270-15  
 15,5 cm, 6"

Klemmschloß  
 Locking Device  
 Cierre para clamps intestinales  
 Serratura per pinze intestinali



**STONE-WATT**  
 65272-07 7,5 cm, 3"  
 65272-10 10,0 cm, 4"



**STONE-WATT**  
 65274-00

Darm-Anastomosenklemmen  
 Intestinal Anastomosis Clamps  
 Clamps para anastomosis intestinales  
 Pinze per anastomosi intestinali

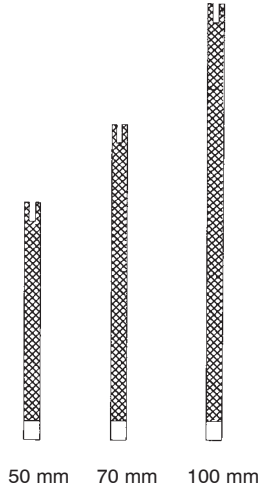

DE MARTEL-WOLFSON  
 65280-05 5 cm, 2" set of 3  
 65280-07 7 cm, 2 3/4" set of 3  
 65280-10 10 cm, 4" set of 3

Klemmschließzange  
 Closing Forceps  
 Pinza para cerrar grapas  
 Serrapinze



DE MARTEL-WOLFSON  
 65282-26 26 cm, 10 1/4"

Klemmenhalterung  
 Clamp Holder  
 Porta-clamp  
 Portapinze



DE MARTEL-WOLFSON  
 65284-08 8,5 cm, 3 1/2"

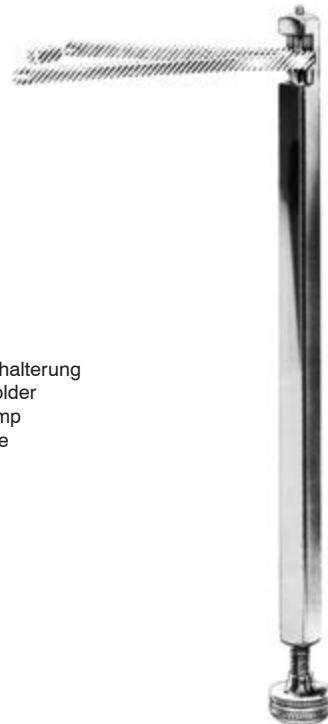

DE MARTEL-WOLFSON  
 65284-23 23 cm, 9"

Magen- und Darm-Zwillingsklemmen  
Stomach and Intestinal Anastomosis Twin Clamps  
Pinzas gastro-intestinales gemelas  
Pinze gastrointestinali gemelle

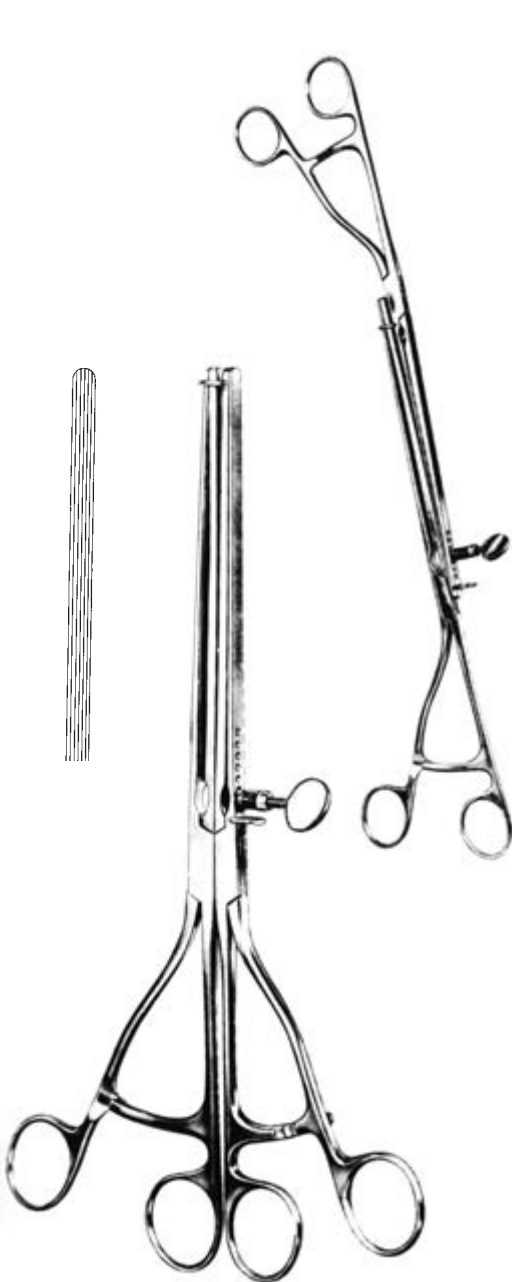

LANE  
65290-30 30 cm, 11 <sup>3</sup>/<sub>4</sub>"



LANE  
65291-30 30 cm, 11 <sup>3</sup>/<sub>4</sub>"

Darm- und Magenquetschklemmen  
 Intestinal and Stomach Clamps  
 Pinzas-clamps intestinales y estomacales  
 Pinze e Schiacciatori per l'intestino e lo stomaco

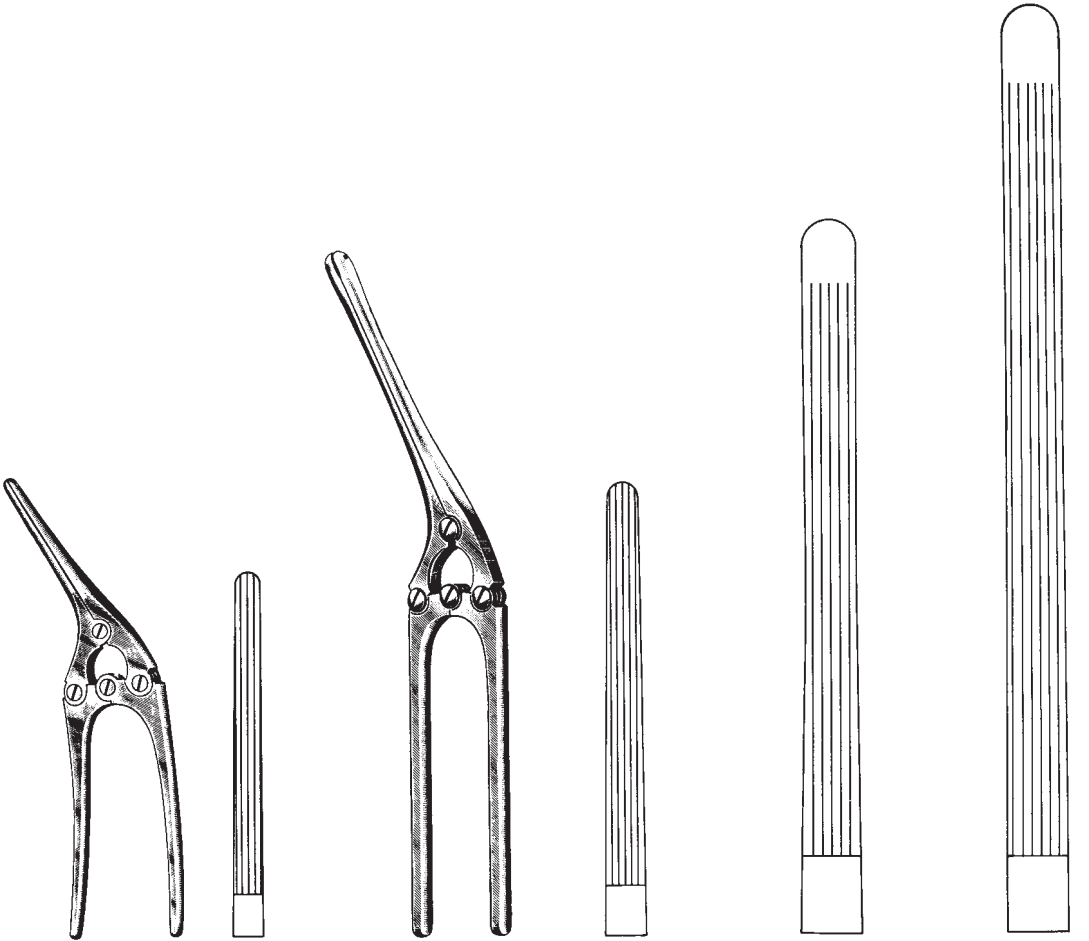

PAYR-BABY  
 65310-15  
 15 cm, 6"

PAYR

65310-21  
 21 cm, 8 1/4"

65310-29  
 29 cm, 11 1/2"

65310-35  
 35 cm, 14"

Magen- und Darmnähhapparat  
 Stomach and Intestinal Suturing Apparatus  
 Aparato para suturar estómago e intestinos  
 Apparecchiature di sutura gastro-intestinale

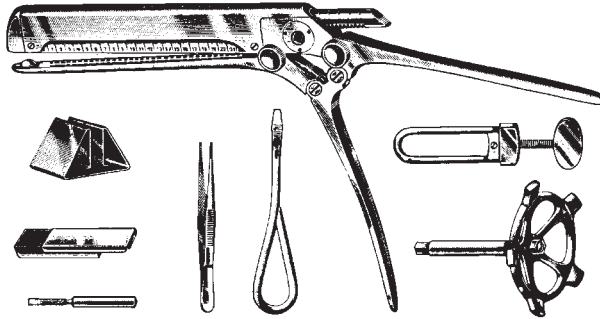

V. PETZ  
 65320-00  
 komplett in Holzetui  
 compl. in wooden case  
 en estuche de madera  
 in astuccio di legno

bestehend aus:

- Nähapparat
- Holzetui
- Zusatzschloß
- Kurbel
- Füllständer
- Füllstift
- Füllpinzette
- Schraubenzieher
- Etui für Klammern
- Silberklammern  
(Pack à 300 Stck.)

consisting of:

- suturing apparatus
- wooden case
- additional closing clamp
- gear wheel
- filling rack
- filling pin
- filling tweezer
- screw driver
- metal box for clips
- silver suturing clips  
(Pack of 300 ea.)

compuesto de:

- Aparator para suturar
- Estuche de madera
- Cierre adicional
- Manivela
- Soporte para rellenar
- Espiga para rellenar
- Pinza para rellenar
- Destornillador
- Estuche para agrafas
- Agrafas para sutura de plata  
(Paquete de 300 pzas.)

composta da:

- apparecchio per la sutura
- astuccio in legno
- Serratura supplementare
- manovella
- supporto di riempimento agraiffe
- perno per posizionare le agraiffe
- pinza per caricare
- cacciavite
- scatola in metallo per agraiffe
- agraiffe in argento  
(confezione da 300 pezz.)

Prostatahaken, Prostatafaßzange, Kapsel­faßzange

Prostatic retractors, Grasping forceps for the capsule – anterior lobe and ligature carrier

Separador para prostata, pinza de agarre para capsula y prostate

Divaricatori per prostata, pinza per afferrare la capsula e prostata

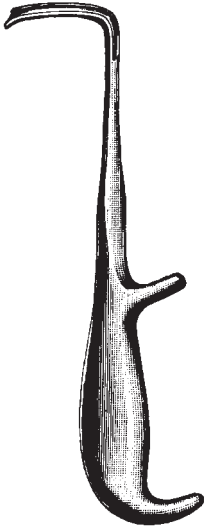

YOUNG  
67101-21  
21 cm, 8 1/4"

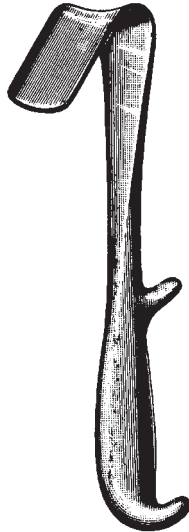

YOUNG  
67103-22  
22 cm, 8 3/4"

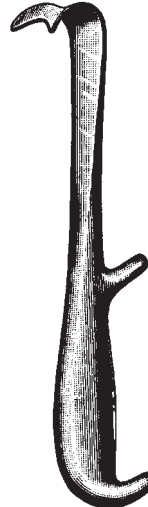

YOUNG  
67105-21  
21 cm, 8 1/4"



YOUNG  
67105-22  
22 cm, 8 3/4"

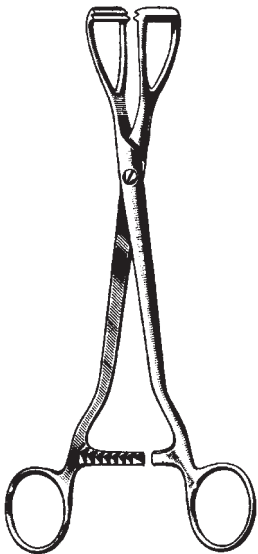

YOUNG  
67106-20  
20 cm, 8"



MILLIN  
67110-23  
23,5 cm, 9 1/4"

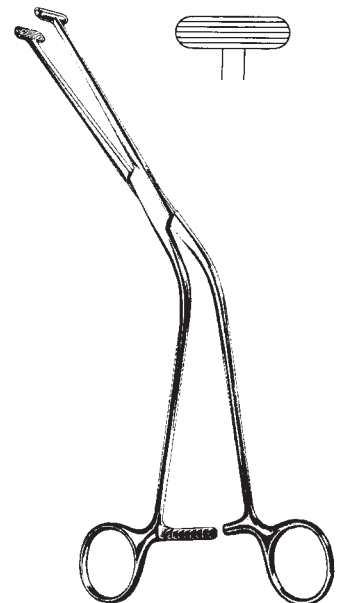

MILLIN  
67111-23  
23 cm, 9"



Kapselfasszange, Fadenführungszange  
Capsule Forceps, Ligature Carrying Forceps  
Pinzas capsulares, Pinza porta ligaduras  
Pinze per afferrare capsule, Pinza porta-filo

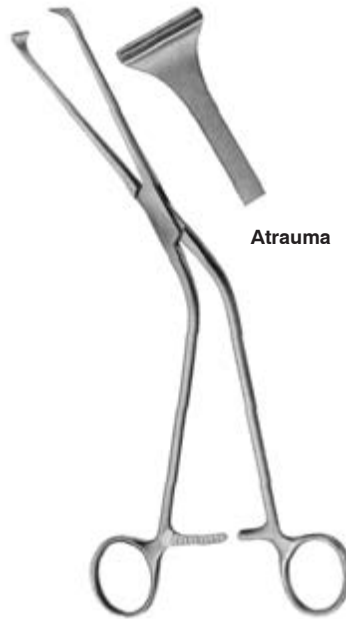

MILLIN  
67122-23  
24,5 cm, 9 3/4"

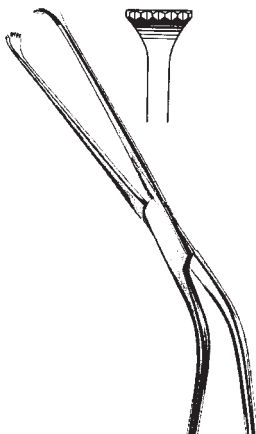

MILLIN  
67123-23  
23 cm, 9"

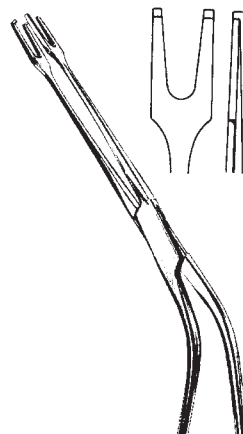

MILLIN  
67125-24  
24 cm, 9 1/2"

Blasenwundspreizer, Blasenspatel  
 Bladder Retractors  
 Separadores vesicales, Espátula vesical  
 Divaricatori vescicali, Spatoli vescicali

67130-01	2 Valven, 2 blades, 2 valvas, 2 valve	57 mm x 25 mm
67130-02	2 Valven, 2 blades, 2 valvas, 2 valve	80 mm x 25 mm
67130-03	1 Valven, 1 blade, 1 valva, 1 valve	120 mm x 45 mm



- 67130-00 ohne Kaltlicht
- 67132-00 Kaltlichtaufsatz für 67130-00
- 67130-00 without fiber optic
- 67132-00 fiber optic light carrier for 67130-00
- 67130-00 sin soporte de luz fría
- 67132-00 soporte de luz fría para 67130-00
- 67130-00 senza fibre ottiche
- 67132-00 supporto per luce fredda per 67130-00



- 67150-00 mit Mittelvalve, with Central Blade  
con valva central, con valva centrale
- 67155-00 ohne Mittelvalve, without Central Blade  
sin valva central, senza valva centr.



Blasenwundspreizer, Blasenhalssperrer, Urethrotome  
 Bladder Retractors, Bladder Neck Spreader, Urethrotomes  
 Separadores vesicales, Uretrótomos  
 Divaricatori vescicali, Divaricatore del collo vescicale, Uretrotomi



LEGUEU  
 67163-00



MILLIN  
 67165-00

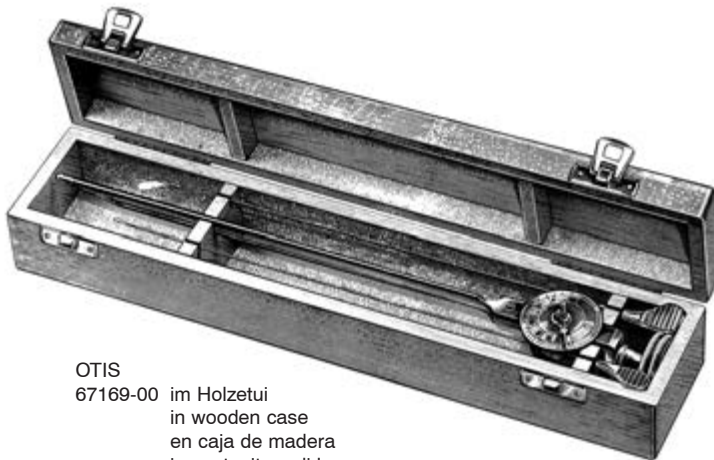

OTIS  
 67169-00 im Holzetui  
 in wooden case  
 en caja de madera  
 in contenitore di legno

67169-01 Ersatzblatt alleine  
 Blade only  
 Hoja de repuesto  
 Lame di ricambio

Fremdkörperzange, Penisklemmen  
 Foreign Body Forceps, Penis Seizing Forceps  
 Pinzas para cuerpos extraños, Compresores uretrales  
 Pinze per corpi estranei, Serrapene

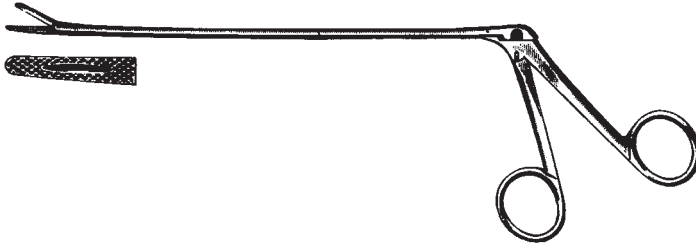

MATHIEU  
 67172-20 20 cm, 8"  
 67172-28 28 cm, 11"



STOCKMANN  
 67175-08  
 8 cm, 3 1/8"



STRAUSS  
 67177-11  
 11 cm, 4 3/8"

Vasektomie-Klemme  
Vasectomy Forceps  
Pinza para vasectomia  
Pinza per vasectomia



67178-12  
12 cm, 4 <sup>3</sup>/<sub>4</sub>"



67178-14  
14 cm, 5 <sup>1</sup>/<sub>2</sub>"

innen Ø 3 mm



67179-14  
14,5 cm, 5 <sup>3</sup>/<sub>4</sub>"

Kathetereinführungsinstrumente, Dilatationsbougies  
 Catheter Introducer, Dilating Bougies  
 Introducator de catéteres, Bujías dilatadoras  
 Mandrini per sonde uretrali, Candelette dilatatrici



67185-35  
 35 cm, 13 3/4"

GUYON  
 67184-39  
 39 cm, 15 1/2"

Charr. FG	28 cm (11") VAN BUREN	25 cm (10") GUYON	28 cm (11") DITTEL	30 cm (11 3/4") DITTEL
8	67201-08	67205-08	67206-08	67207-08
9			67206-09	67207-09
10	67201-10	67205-10	67206-10	67207-10
11			67206-11	67207-11
12	67201-12	67205-12	67206-12	67207-12
13			67206-13	67207-13
14	67201-14	67205-14	67206-14	67207-14
15			67206-15	67207-15
16	67201-16	67205-16	67206-16	67207-16
17			67206-17	67207-17
18	67201-18	67205-18	67206-18	67207-18
19			67206-19	67207-19
20	67201-20	67205-20	67206-20	67207-20
21			67206-21	67207-21
22	67201-22	67205-22	67206-22	67207-22
23			67206-23	67207-23
24	67201-24	67205-24	67206-24	67207-24
25			67206-25	67207-25
26	67201-26	67205-26	67206-26	67207-26
27			67206-27	67207-27
28	67201-28	67205-28	67206-28	67207-28
29			67206-29	67207-29
30	67201-30	67205-30	67206-30	67207-30
32	67201-32	67205-32		
34	67201-34	67205-34		
36	67201-36	67205-36		
38		67205-38		
40		67205-40		

Metallkatheter  
 Metal Catheters  
 Sondas metálicas  
 Sonde metalliche

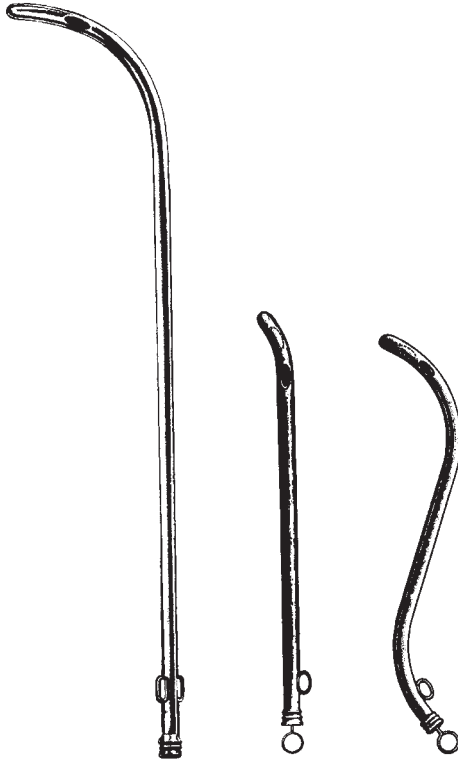

29 cm  
 11 1/2"

15 cm  
 6"

COXETER

WALTHER  
 5 1/4"  
 67220-00 (Set)

Charr.  
 FG

6	67211-06	67213-06	
8	67211-08	67213-08	67219-08
10	67211-10	67213-10	67219-10
12	67211-12	67213-12	67219-12
14	67211-14	67213-14	67219-14
16	67211-16	67213-16	67219-16
18	67211-18	67213-18	67219-18
20	67211-20	67213-20	67219-20
22	67211-22	67213-22	67219-22
24	67211-24	67213-24	67219-24

67220-12	12 Fr.
67220-14	14 Fr.
67220-16	16 Fr.
67220-18	18 Fr.
67220-20	20 Fr.
67220-22	22 Fr.
67220-24	24 Fr.
67220-26	26 Fr.
67220-28	28 Fr.
67220-30	30 Fr.
67220-32	32 Fr.
67220-34	34 Fr.
67220-36	36 Fr.
67220-38	38 Fr.

Beschneidungsinstrument  
Circumcision Instrument  
Instrumentos para circuncisión  
Strumenti per circoncisione

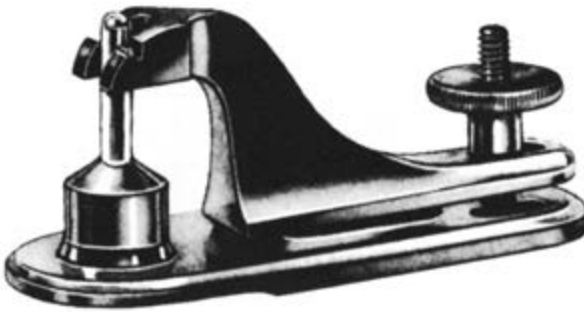

67240-08	8 mm Ø
67240-11	11 mm Ø
67240-13	13 mm Ø
67240-16	16 mm Ø
67240-21	21 mm Ø
67240-26	26 mm Ø
67240-32	32 mm Ø

67240-08 - 67240-32



MOGEN

67250-07	7,5 cm (3")	2,5 mm
67251-07	7,5 cm (3")	1,5 mm
		für Kinder
		for children
		para niños
		per bambini







Mastdarm-Spekula  
Rectal Specula  
Espéculos rectales  
Specoli rettali



CZERNY  
69105-22  
22 cm, 8 <sup>3</sup>/<sub>4</sub>"



SIMS  
69110-15  
15 cm, 6"



BODENHAMMER  
69115-15  
15 cm, 6"

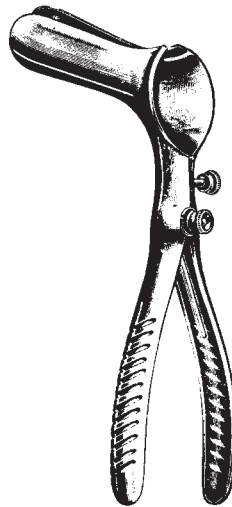

PRATT  
69121-00  
19 cm, 7 <sup>1</sup>/<sub>2</sub>"

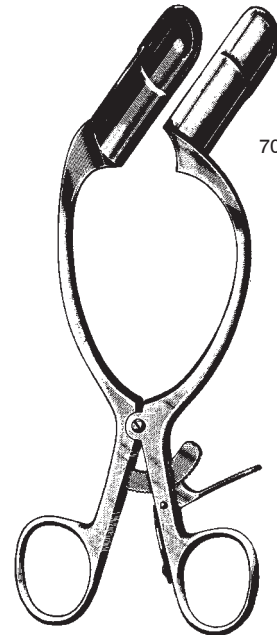

70x22 mm

BARR  
69125-17  
17 cm, 6 <sup>3</sup>/<sub>4</sub>"

Mastdarm-Spekula  
Rectal Specula  
Espéculos rectales  
Specoli rettali

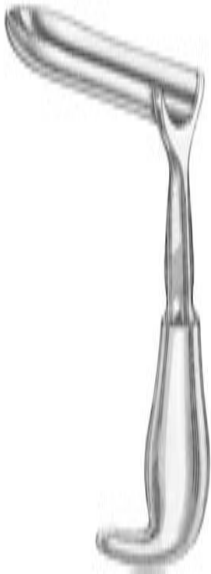

HILL-FERGUSON, 20 cm, 8"  
69126-01 6,4x2,2 cm 2 1/2" x 7/8"  
69126-02 7,6x3,0 cm 3" x 1 3/16"  
69126-03 7,6x3,6 cm 3" x 1 7/16"

SAWYER, 25 cm, 9 3/4"  
69127-01 6,4x2,2 cm 2 1/2" x 7/8"  
69127-02 7,6x2,9 cm 3" x 1 1/8"  
69127-03 8,9x3,8 cm 3 1/2" x 1 1/2"

MATHIEU  
69130-19  
19,5 cm, 7 3/4"



SCHULZE-BERGMANN  
69142-06 - 69142-12

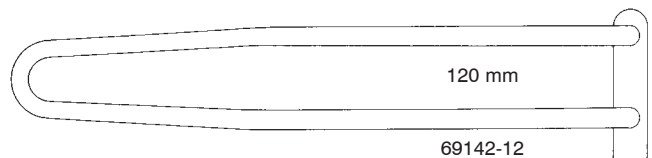
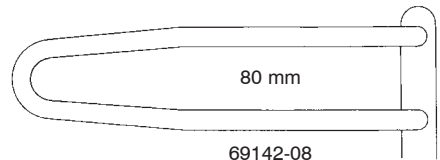
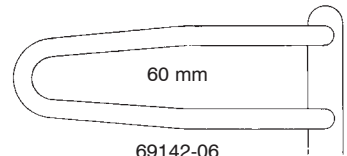

Analspreizer  
 Anal Retractors  
 Separadores rectales  
 Dilatatori per l'ano e il retto

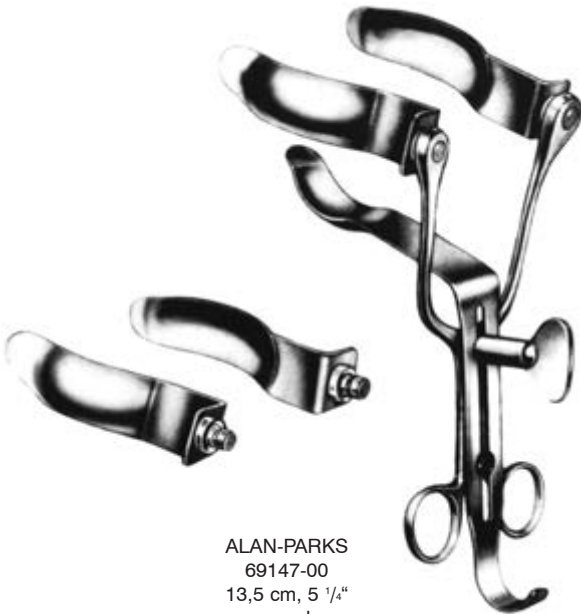

ALAN-PARKS  
 69147-00  
 13,5 cm, 5 1/4"  
 compl.

69148-00  
 Kaltlicht Zubehör für 69147-00  
 Cold Light Attachment for 69147-00  
 Adaptador para luz fría 69147-00  
 Adattatore luce fredda per 69147-00

- 69147-01 Sperrer allein  
 Spreader only  
 Separador rectal solo  
 Solo telaio senza valve
- 69147-02 Mittelblatt allein  
 Center blade, only  
 Valva central, solo  
 Valva centrale, sola
- 69147-03 Blatt allein 75 mm, 3"  
 Blade only 75 mm, 3"  
 Valva sola 75 mm, 3"  
 Valva sola 75 mm, 3"
- 69147-04 Blatt allein 95 mm, 3 3/4"  
 Blade only 95 mm, 3 3/4"  
 Valva sola 95 mm, 3 3/4"  
 Valva sola 95 mm, 3 3/4"

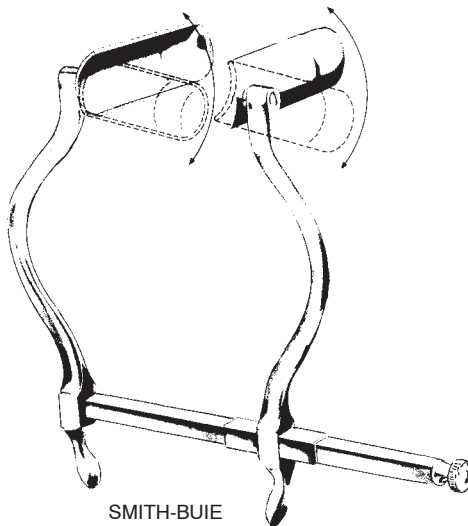

SMITH-BUIE  
 69150-15  
 15 cm, 6"  
 75x23 mm

Anuskope, Proktoskope  
 Anoscopes, Proctoscopes  
 Anoscopios, Proctoscopios  
 Anoscopi, Protoscopi

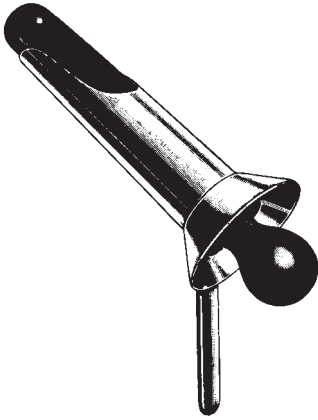

IVES-FANSLER  
 69210-22 22 mm Ø  
 L = 80 mm



Ø mm HIRSCHMANN  
 16 69212-16  
 19 69212-19  
 22 69212-22  
 L = 65 mm



mm  
 ØxL KELLY  
 22x 50 69220-05  
 22x100 69220-10  
 22x140 69220-14  
 22x200 69220-20

Sphinkteroskope, Proktoskope, Fistelsonde  
 Sphincteroscopes, Proctoscopes, Fistula Probe  
 Sfinteroscopios, Proctoscopios, Sondas para fistulas  
 Sfinteroscopi, Protoscopi, Sonde per fistole



Ø mm KELLY  
 21 69224-21  
 27 69224-27  
 L = 50 mm, 2"

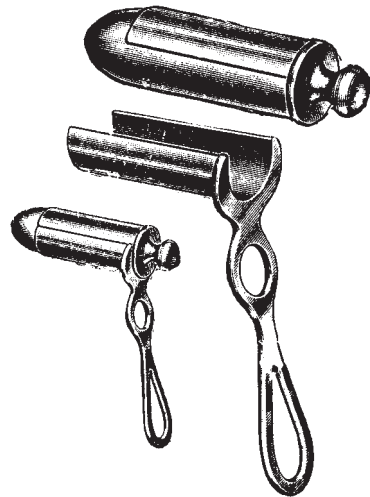

Ø mm CHELSEA-EATON  
 22 x 65 69225-22  
 30 x 65 69225-30



Fig. 1  
 69251-01



Fig. 2  
 69251-02



Fig. 3  
 69251-03

PRATT  
 21 cm, 8 1/4"  
 69251-01 - 69251-03

Proktoskope  
Proctoscopes  
Proctoscopios  
Protoscopi

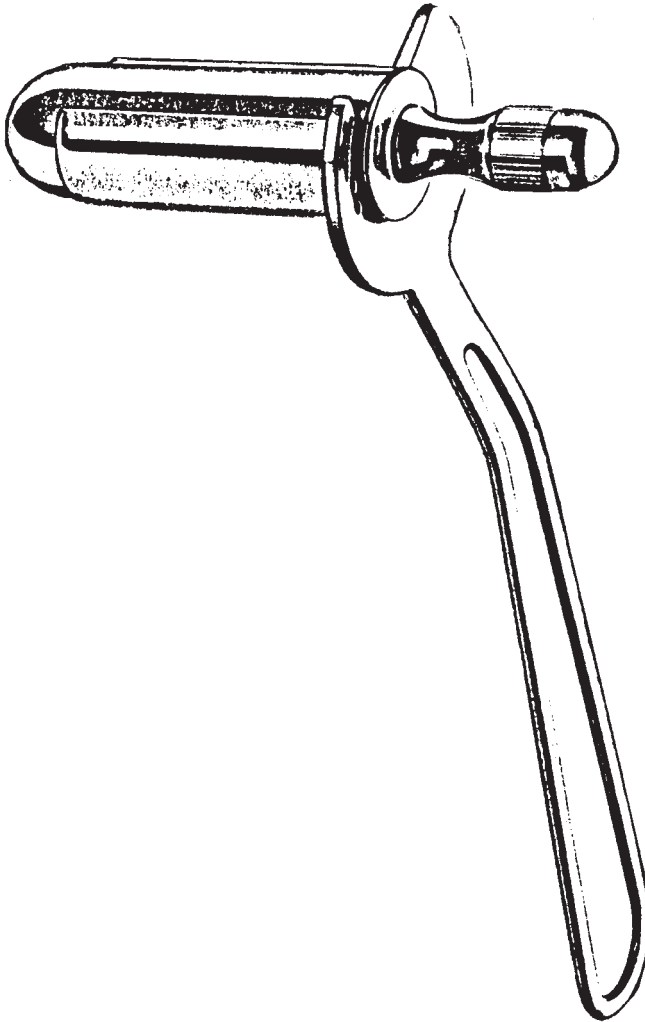

Ø	L	FANSLER, 24 cm, 9 1/2"
25 x 65 mm		69226-25
29 x 65 mm		69226-29
38 x 70 mm		69226-38



Proktoskope  
 Proctoscopes  
 Proctoscopios  
 Protoscopi



MORGAN

- 69227-01 17 mm Ø L=65 mm
- 69227-02 17 mm Ø L=80 mm
- 69227-03 20 mm Ø L=65 mm
- 69227-04 20 mm Ø L=80 mm
- 69227-05 24 mm Ø L=65 mm
- 69227-06 24 mm Ø L=80 mm

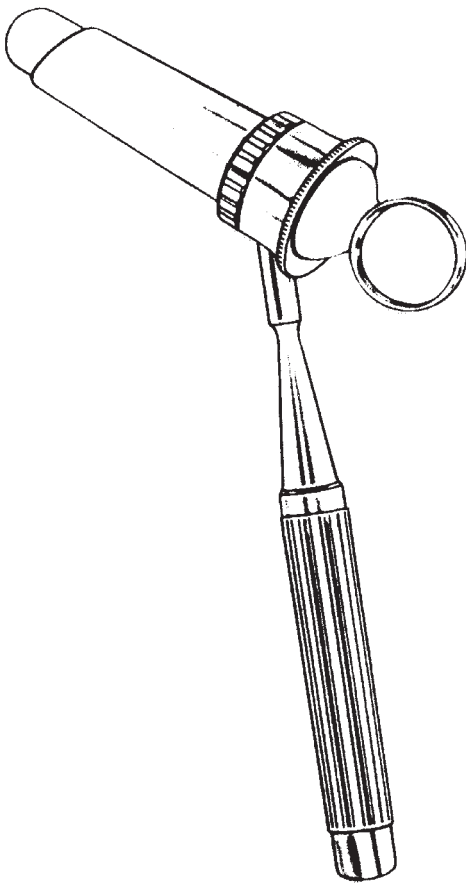

69228-01

Beleuchtungsstab für MORGAN  
 Illumination attachment for MORGAN  
 Mango con iluminación para MORGAN  
 Dispositivo Illuminativo per MORGAN

BENSAUDE

- 69229-01 19 mm Ø L=70 mm
- 69229-02 22 mm Ø L=70 mm

Rektal Absaugrohr, Rektalschnürer, Mastdarmbiopsiezangen  
 Rectal aspiration cannula, Rectal snare, Rectal Biopsy Specimen Forceps  
 Cánula de aspiración rectal, Cierra-nudo rectal, Pinzas para biopsia rectal  
 Cannula d'aspirazione rettale, Serranodi, Pinze taglianti per biopsia rettale



BUIE  
 69261-41  
 41 cm, 16"

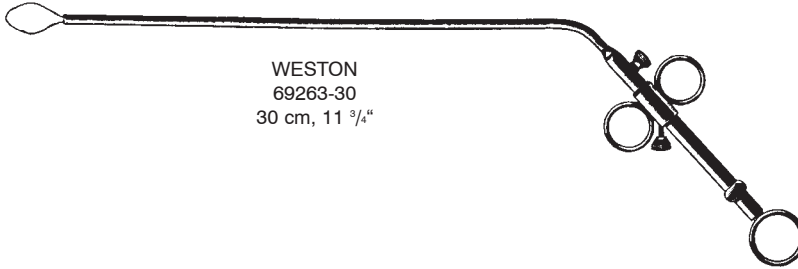

WESTON  
 69263-30  
 30 cm, 11 3/4"



YEOMAN  
 69301-28 - 69304-42

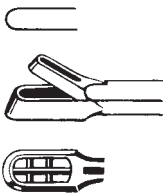

Fig. 1  
 69301-28 28 cm, 11"  
 69301-35 35 cm, 13 3/4"  
 69301-42 42 cm, 16 1/2"

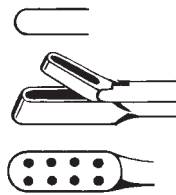

Fig. 2  
 69302-28 28 cm, 11"  
 69302-35 35 cm, 13 3/4"  
 69302-42 42 cm, 16 1/2"

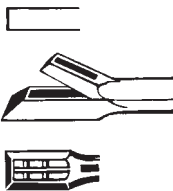

Fig. 3  
 69303-28 28 cm, 11"  
 69303-35 35 cm, 13 3/4"  
 69303-42 42 cm, 16 1/2"

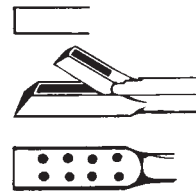
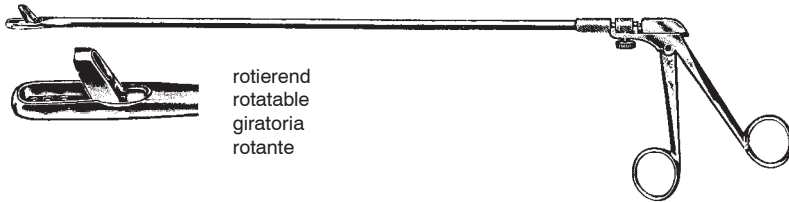

Fig. 4  
 69304-28 28 cm, 11"  
 69304-35 35 cm, 13 3/4"  
 69304-42 42 cm, 16 1/2"

Mastdarm-Biopsiezangen, Hämorrhoidalzange  
Rectal Biopsy Specimen Forceps, Haemorrhoidal Forceps  
Pinzas para biopsia rectal, Pinzas-clamps hemorroidales  
Pinze taglianti per biopsia rettale, Pinze per emorroidi



rotierend  
rotatable  
giratoria  
rotante

YEOMANN

69311-23 23 cm, 9"

69311-33 33 cm, 13"

69311-40 40 cm, 15 3/4"

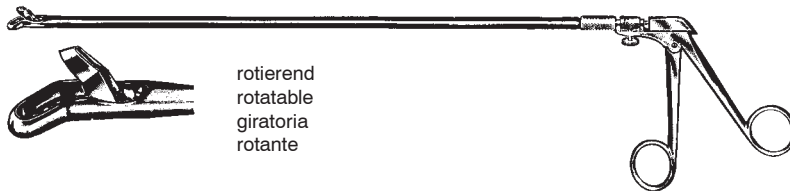

rotierend  
rotatable  
giratoria  
rotante

TURREL

69321-23 23 cm, 9"

69321-33 33 cm, 13"

69321-40 40 cm, 15 3/4"



HEYWOOD-SMITH

69402-21 21 cm, 8 1/4"

69402-25 25 cm, 10"

Hämorrhoidal-Ligatoren, Hämorrhoidal-Fasszange  
 Haemorrhoidal Ligators, Haemorrhoidal Forceps  
 Ligadores para hemorroides, Pinzas-clamps para hemorroides  
 Legatori emorroidali, Pinze per emorroidi

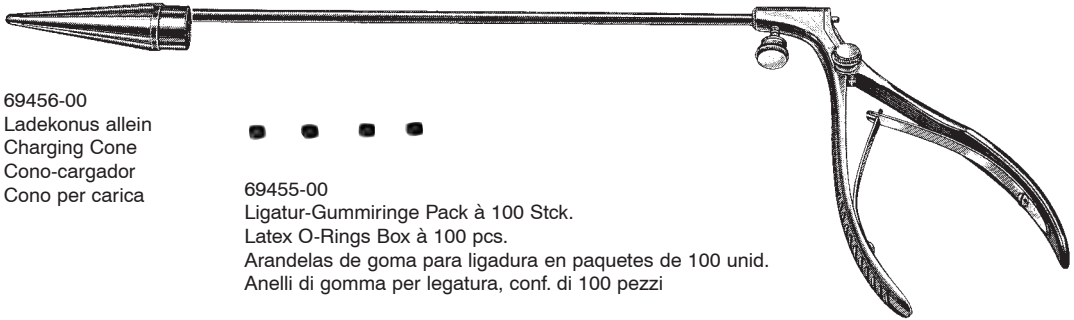

69456-00  
 Ladekonus allein  
 Charging Cone  
 Cono-cargador  
 Cono per carica



69455-00  
 Ligatur-Gummiringe Pack à 100 Stck.  
 Latex O-Rings Box à 100 pcs.  
 Arandelas de goma para ligadura en paquetes de 100 unid.  
 Anelli di gomma per legatura, conf. di 100 pezzi

MC GIVNEY  
 69450-18  
 18 cm, 7"

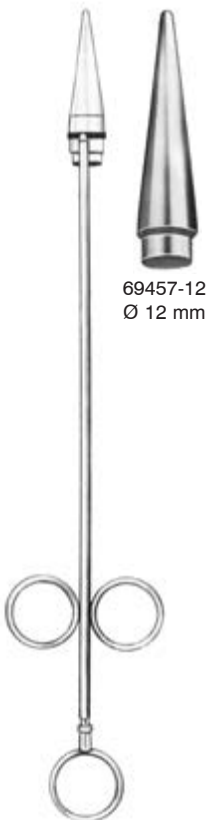

69457-12  
 Ø 12 mm

RUDD  
 69457-31  
 31,5 cm, 12 1/2"  
 kplt./cpt.

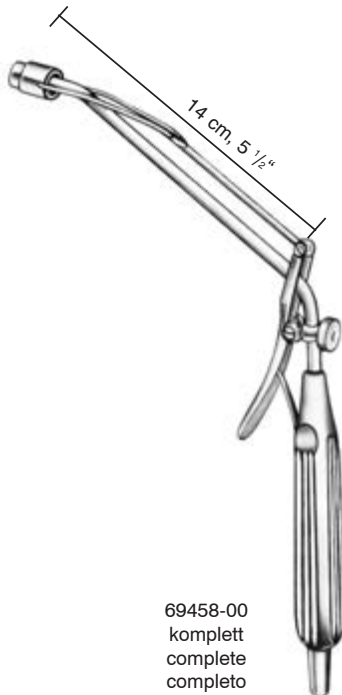

69458-00  
 komplett  
 complete  
 completo



Ø 10 mm  
 69458-10  
 Ladekonus  
 Charging cone  
 Cono-cargador  
 Cono per carica



Ø 10 mm  
 69458-11 11 mm  
 69458-16 16 mm  
 Saugkopf  
 Aspiration tip  
 Cabeza de aspiración  
 Testa d'aspirazione

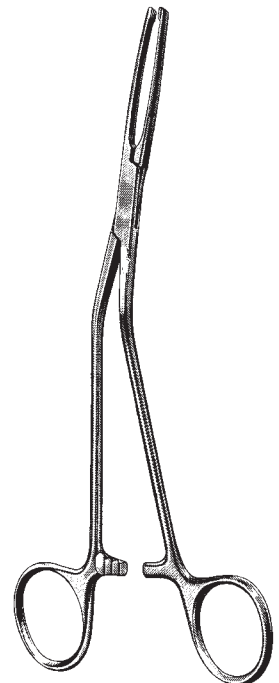

MC GIVNEY  
 69460-00  
 19 cm, 7 1/2"

Lateral-Scheidenspekula  
 Lateral Vaginal Retractor  
 Espécúlos vaginales  
 Specoli vaginali



71100-00

Lateralspreizer allein  
 Vaginal retractor lateral only  
 Espéculo vaginal solo  
 Specolo vaginale laterale, solo

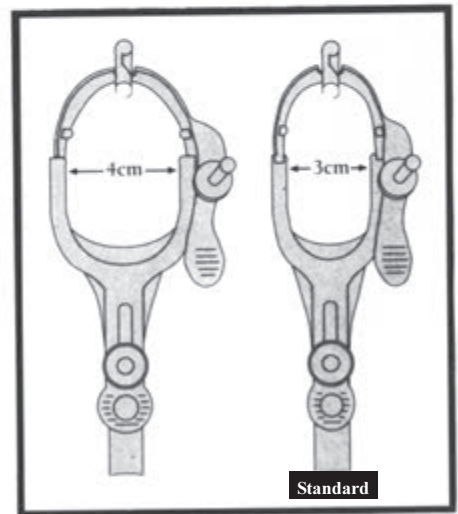

**VU-MORE**

Fig.	mm	
2	95x35	71115-02
3	115x35	71115-03

Scheidenspekula  
Vaginal Specula  
Especulos vaginales  
Specoli vaginali

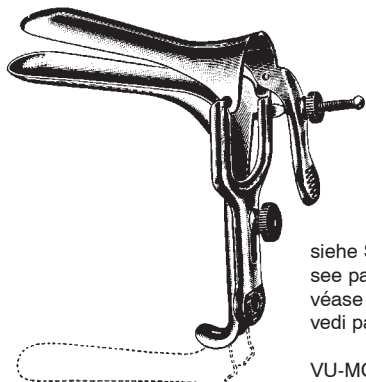

siehe Seite 569  
see page no. 569  
véase pagina no. 569  
vedi pagina nr. 569

VU-MORE

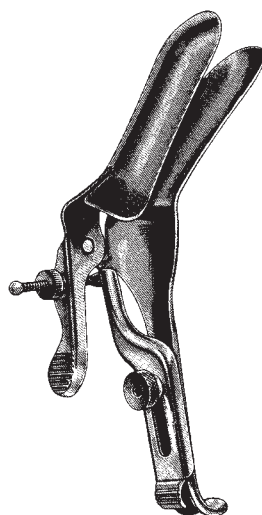

rechts offen  
open right-side  
abierto a la derecha  
aperta a destra

GRAVE

71116-02

mittel, medium, mediano, medio  
101x35 mm

GRAVE

Fig.	mm	Standard
1	75x20	71110-01
2	95x35	71110-02
3	115x35	71110-03

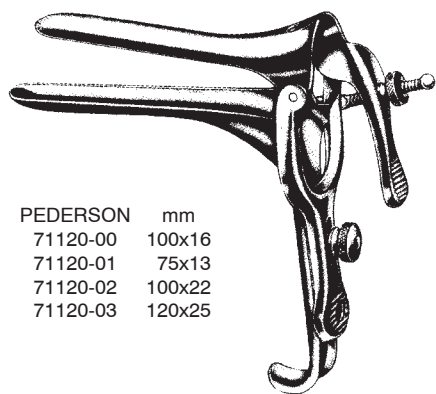

Fig.	PEDERSON	mm
	71120-00	100x16
1	71120-01	75x13
2	71120-02	100x22
3	71120-03	120x25

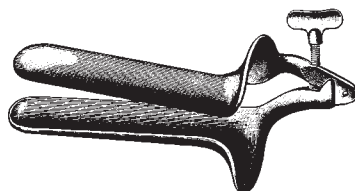
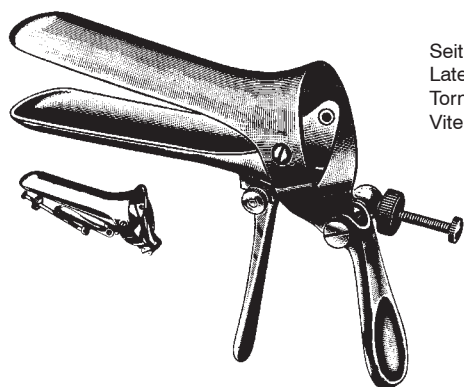

Fig.	COLLIN	mm
1	71130-01	85x30
2	71130-02	100x35
3	71130-03	110x40



Seitliche Schraube  
Lateral Screw  
Tornillo lateral  
Vite laterale

CUSCO

Fig.	mm	Standard
1	75x32	71140-01
2	85x35	71140-02
3	100x35	71140-03
4	75x17	71142-04

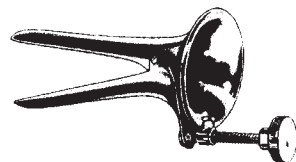

COLLIN  
71132-00  
65x10 mm

für Jungfrauen  
for virgin  
para vírgenes  
per vergini

Scheidenspekula  
 Vaginal Specula  
 Espécúlos vaginales  
 Specoli vaginali

Mittelschraube  
 Central Screw  
 Tornillo central  
 Vite centrale

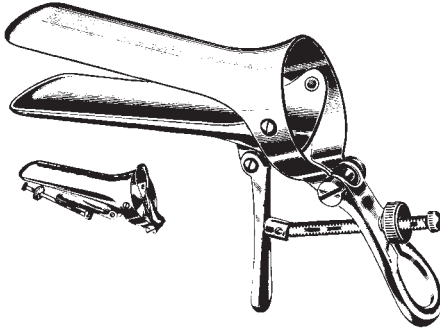

Fig.	CUSCO	mm
1	71150-01	75x32
2	71150-02	85x35
3	71150-03	100x37

Schweizer Modell  
 Swiss Pattern  
 Modelo suizo  
 Modello svizzero

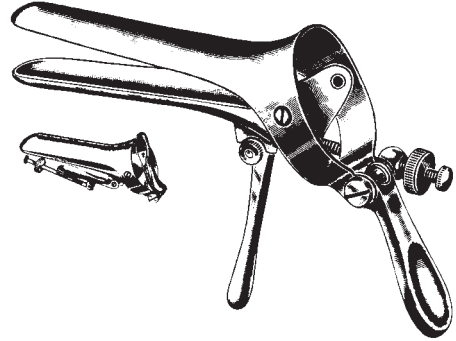
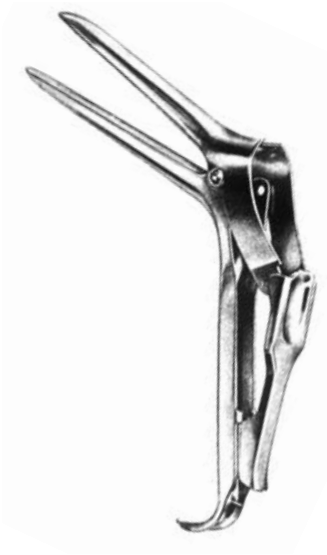

Fig.	CUSCO	mm
1	71160-01	90x23-25
2	71160-02	100x25-27
3	71160-03	110x27-30



SEMM		mm
71161-17	100 x 17 - 20 mm	
71161-25	100 x 25 - 30 mm	



Fig.	TRÉLAT	mm
1	71170-01	85x33
2	71170-02	95x35
3	71170-03	115x43

Scheidenspekula  
Vaginal Specula  
Espéculos vaginales  
Specoli vaginali

Satz bestehend aus je 1 Spekula und 1 Halter  
Set consisting of 1 specula and 1 retractor  
Juego de 1 espéculo y 1 valva  
Serie da 1 specolo e 1 valva

Spekula  
Speculum  
Espéculo  
Specolo

Halter  
Retractor  
Valva  
Valve



Fig. KRISTELLER  
1 71210-01  
2 71210-02  
3 71210-03

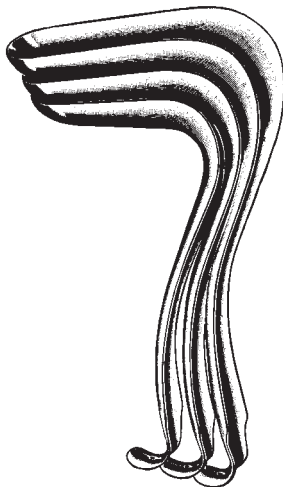

Fig. KRISTELLER mm  
1 71211-01 70x27  
2 71211-02 80x30  
3 71211-03 90x36



Fig. KRISTELLER mm  
1 71212-01 75x23  
2 71212-02 85x26  
3 71212-03 100x32



Fig. KRISTELLER  
00 71240-00  
0 71240-10  
1 71240-01  
2 71240-02  
3 71240-03

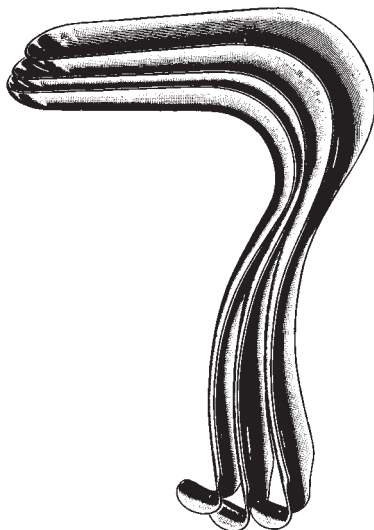

Fig. KRISTELLER mm  
00 71241-00 110x18  
0 71241-10 110x21  
1 71241-01 110x27  
2 71241-02 110x30  
3 71241-03 110x36

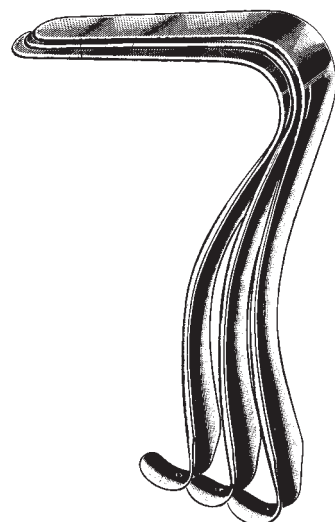

Fig. KRISTELLER mm  
00 71242-00 115x14  
0 71242-10 115x17  
1 71242-01 115x23  
2 71242-02 115x26  
3 71242-03 115x32



Scheidenspekula  
Vaginal Specula  
Espéculos vaginales  
Specoli vaginali



KALLMORGEN  
71260-01 - 71262-02

Fig.	Serie	Spekula Speculum Espéculo Specolo	Halter Retractor Valva	mm	Valve	mm
1	71260-01	71261-01	70x40	71262-01	70x33	
2	71260-02	71261-02	90x40	71262-02	90x33	

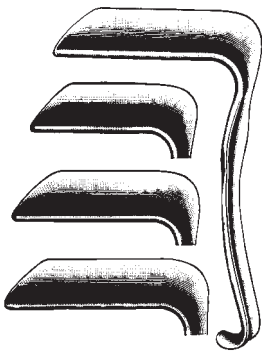

Fig.	JACKSON	mm
1	71271-01	75x38
2	71271-02	90x38
3	71271-03	100x38



Fig.	SIMS	mm
1	71281-01	63x32
2	71281-02	76x32
3	71281-03	89x38

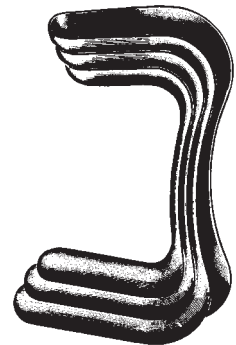

Fig.	SIMS	mm
1	71291-01	60x25+30
2	71291-02	70x30+35
3	71291-03	80x35+40
Set	71291-00	(Fig. 1,2,3)

Scheidenspekula  
Vaginal Specula  
Espéculos vaginales  
Specoli vaginali



DELEE  
71300-01  
23,5 cm, 9 1/4"

leicht hohl  
slightly concave  
ligeramente concavos  
leggermente concavi

Fig.		mm
1	71301-01	55x35
2	71301-02	85x35
3	71301-03	115x35

Fig.		mm
1	71303-01	55x45
2	71303-02	85x45
3	71303-03	115x45
4	71303-04	160x45
5	71303-05	180x45

Fig.		mm
1	71305-01	55x60
2	71305-02	85x60
3	71305-03	115x60
4	71305-04	160x60
5	71305-05	180x60



35 mm  
1.4"



45 mm  
1.8"



60 mm  
2.4"

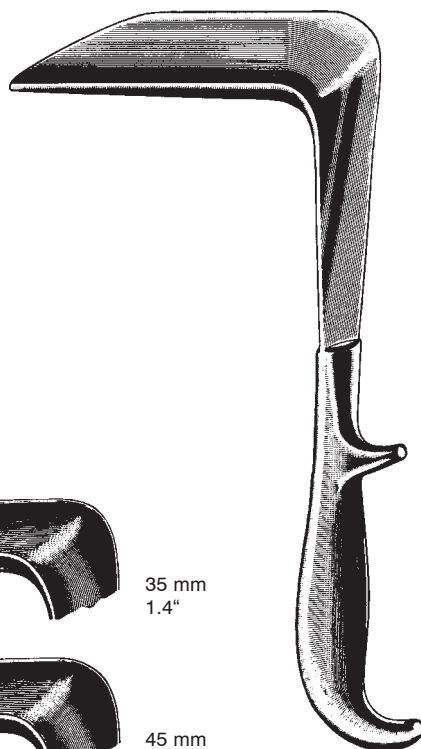

DOYEN  
24 cm, 9 1/2"

Scheidenspekula  
Vaginal Specula  
Espéculos vaginales  
Specoli vaginali

71306-01  
80 x 30 mm

71306-02  
85 x 35 mm

71306-03  
90 x 40 mm



71306-04  
Gewicht 400 gr  
weight 400 grs  
peso 400 grs  
peso 400 grs

71306-05  
Gewicht 800 gr  
weight 800 grs  
peso 800 grs  
peso 800 grs



71306-01 - 71306-03

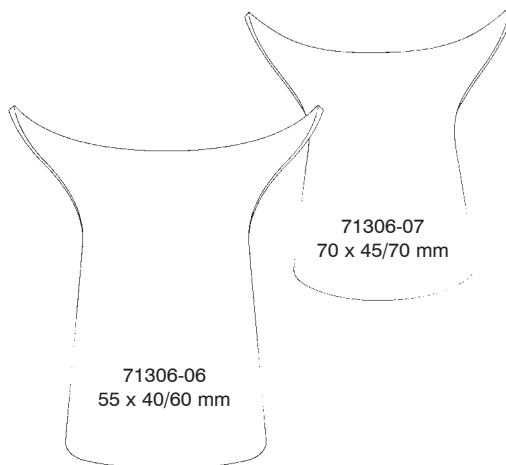
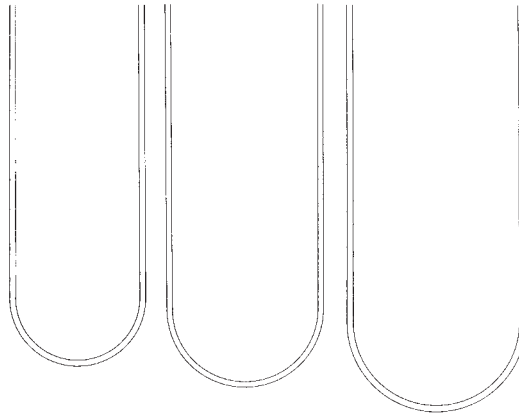

71306-07  
70 x 45/70 mm

71306-06  
55 x 40/60 mm

SCHERBAK  
71306-00  
Set komplett  
complete set  
juego completo  
set completo



71306-08  
Griff, handle,  
mango, manico

Scheidenspekula  
Vaginal Specula  
Espéculos vaginales  
Specoli vaginali



O'SULLIVAN-O'CONNOR  
71308-00



Fig. 1 = 45 x 17 mm 71308-01  
Fig. 2 = 90 x 37 mm 71308-02  
Fig. 3 = 90 x 45 mm 71308-03

71308-00

komplett bestehend aus:

1 Rahmen mit 2 beweglichen Seitenvalven  
3 austauschbare Mittelvalven Fig. 1-3

1 frame with 2 mobile lateral blades  
3 interchangeable blades Fig. 1-3

1 Marco con 2 separadores móviles laterales  
3 separadores centrales intercambiables fig. 1-3

1 telaio regolabile con 2 valve laterali mobili  
3 valve intercambiabili fig. 1-3

71308-04  
Rahmen allein  
Frame only  
Marco solo  
Telaio solo

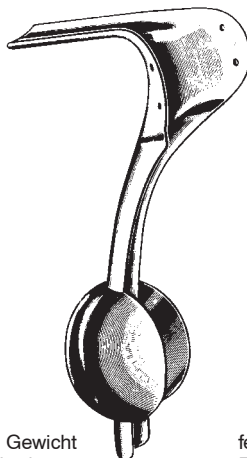

abnehmbares Gewicht  
Detachable Weight  
Peso desmontable  
Peso smontabile

71307-00  
1,4 kg  
75 x 38 mm

AUVARD  
24 cm, 9 1/2"

festes Gewicht  
Fixed Weight  
Peso fijo  
Peso fisso

71309-00  
1,4 kg  
105 x 38 mm

Scheidenspekula, Endospekula  
 Vaginal Specula, Endospecula  
 Espéculos vaginales, Endo-espéculos  
 Specoli vaginali, Endospecoli



mm	BREISKY	
100x20	71310-20	28 cm, 11"
100x25	71310-25	28 cm, 11"
100x30	71310-30	28 cm, 11"
100x35	71310-35	28 cm, 11"
100x40	71310-40	28 cm, 11"
130x20	71313-20	33 cm, 13"
130x25	71313-25	33 cm, 13"
130x30	71313-30	33 cm, 13"
130x35	71313-35	33 cm, 13"
130x40	71313-40	33 cm, 13"
155x40	71315-40	35 cm, 13 3/4"



mm	LANDAU	
100x28	71319-28	29 cm, 11 1/2"
100x38	71319-38	29 cm, 11 1/2"

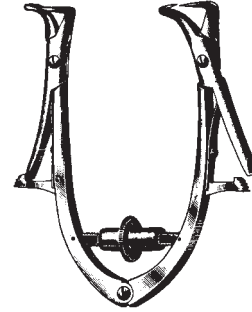

	JOLL (FRIEDMANN)	
71351-10		10 cm, 4"
71351-15		15 cm, 6"



	KOGAN	
71360-24	3 mm	24 cm, 9 1/2"
71361-24	4 mm	24 cm, 9 1/2"
71362-24	5 mm	24 cm, 9 1/2"



	KOGAN	
71363-24	3 mm	24 cm, 9 1/2"
71364-24	4 mm	24 cm, 9 1/2"
71365-24	5 mm	24 cm, 9 1/2"

Uterus Dilatatore  
 Uterine Dilators  
 Dilatadores uterinos  
 Dilatatori uterini

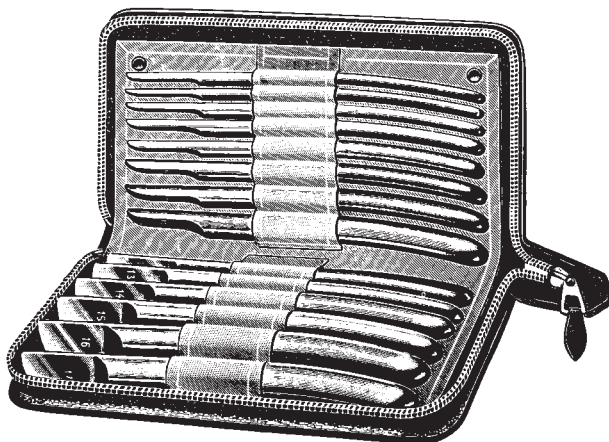

HEGAR  
 71405-14 4-17 mm  
 14 St./pces./pzas./pezzi

mm Ø	HEGAR	mm Ø
1	71410-01	71415-01 1,5
2	71410-02	71415-02 2,5
3	71410-03	71415-03 3,5
4	71410-04	71415-04 4,5
5	71410-05	71415-05 5,5
6	71410-06	71415-06 6,5
7	71410-07	71415-07 7,5
8	71410-08	71415-08 8,5
9	71410-09	71415-09 9,5
10	71410-10	71415-10 10,5
11	71410-11	71415-11 11,5
12	71410-12	71415-12 12,5
13	71410-13	71415-13 13,5
14	71410-14	71415-14 14,5
15	71410-15	71415-15 15,5
16	71410-16	71415-16 16,5
17	71410-17	71415-17 17,5
18	71410-18	71415-18 18,5
19	71410-19	71415-19 19,5
20	71410-20	
21	71410-21	
22	71410-22	
23	71410-23	
24	71410-24	
25	71410-25	
26	71410-26	
27	71410-27	
28	71410-28	
29	71410-29	
30	71410-30	

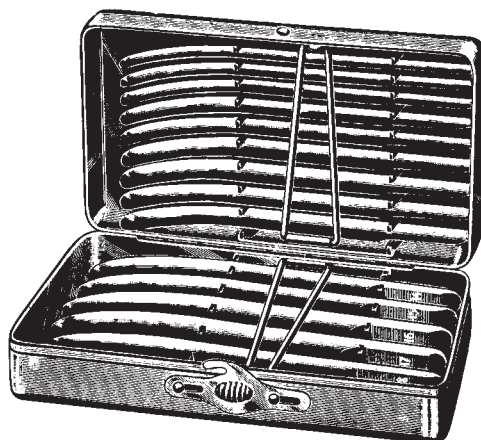

mm HEGAR  
 4-17 71406-14 14 St./pces./pzas./pezzi  
 1-26 71406-26 26 St./pces./pzas./pezzi

71404-14 Satz/Set/Juego/Set  
 71410-04 - 71410-17 = 14

71404-26 Satz/Set/Juego/Set  
 71410-01 - 71410-26 = 26

in Metalletui, in metal case,  
 en estuche de metal, in astuccio metallico

Uterus Dilatatore  
 Uterine Dilators  
 Dilatadores uterinos  
 Dilatatori uterini

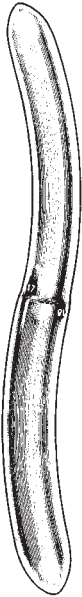

mm	HEGAR
1/ 2	71420-01
3/ 4	71420-03
5/ 6	71420-05
7/ 8	71420-07
9/10	71420-09
11/12	71420-11
13/14	71420-13
15/16	71420-15
17/18	71420-17
19/20	71420-19
21/22	71420-21
23/24	71420-23
25/26	71420-25

71424-08 Satz/Set/Juego/Set  
 71420-03 - 71420-17 = 8  
 3/4 - 17/18 mm

71424-13 Satz/Set/Juego/Set  
 71420-01 - 71420-25 = 13  
 1/2 - 25/26 mm

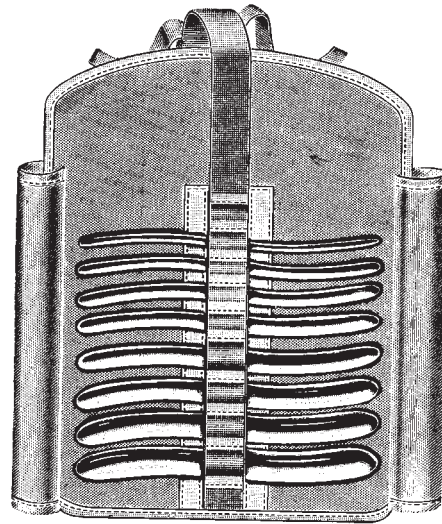

mm HEGAR  
 3/4 - 17/18 71425-08 8 St./pces./pzas./pezzi

in Stofftasche, in khaki roll,  
 en bolsa de tela, in borsa di tela

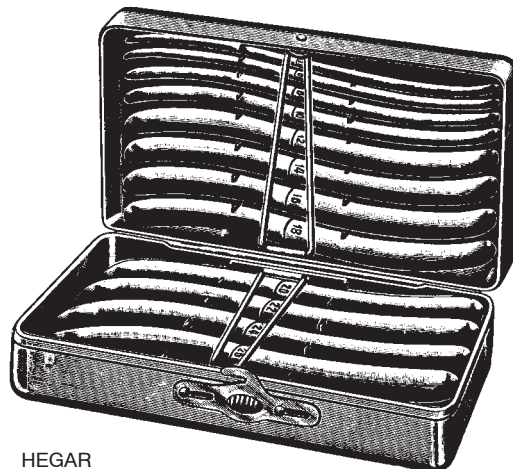

mm HEGAR  
 3-4 - 17/18 71426-08 8 St./pces./pzas./pezzi  
 1/2 - 25/26 71426-13 13 St./pces./pzas./pezzi

in Metalletui, in metal case,  
 en estuche de metal, in astuccio metallico

Uterus Dilatatore  
 Uterine Dilators  
 Dilatadores uterinos  
 Dilatatori uterini

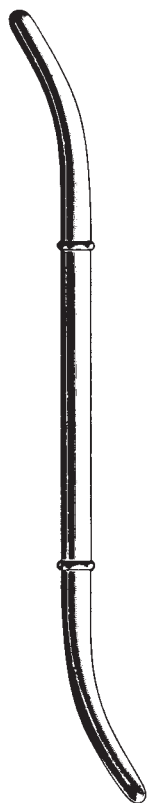

in Stofftasche  
 in khaki roll  
 en bolsa de tela  
 in borsa di tela

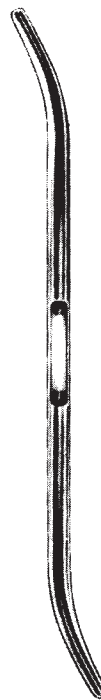
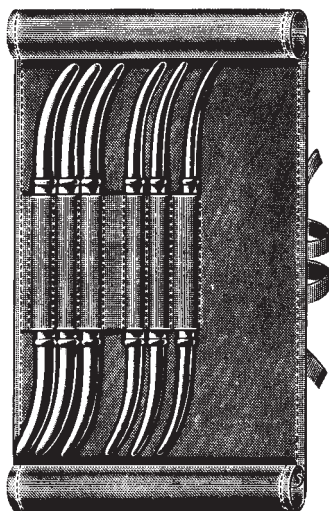

Fig.	mm/Ø	HANK
9/10	4,5/5	71430-10
11/12	5,5/6	71430-12
13/14	6,5/7	71430-14
15/16	7,5/8	71430-16
17/18	8,5/9	71430-18
19/20	9,5/10	71430-20

71436-06  
 Satz, set, juego, serie = 6

Fig./U.S.	mm/Ø	PRATT
13/15	4,5/5	71438-13
17/19	5,6/6,3	71438-17
21/23	7/7,6	71438-21
25/27	8,3/9	71438-25
29/31	9,6/10,3	71438-29
33/35	11/11,6	71438-33
37/39	12,3/13	71438-37
41/43	13,6/14,3	71438-41

71438-00  
 Satz, set, juego, serie = 8



Uterus Dilatatore  
Uterine Dilators  
Dilatadores uterinos  
Dilatatori uterini

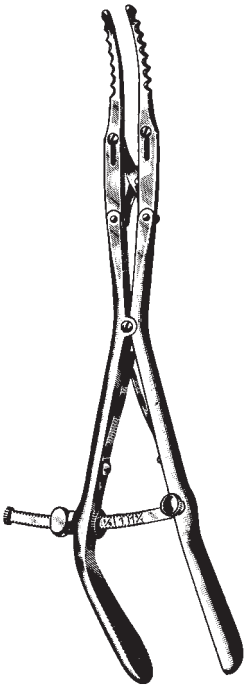

GOODELL  
71441-34  
34 cm, 13 1/2"

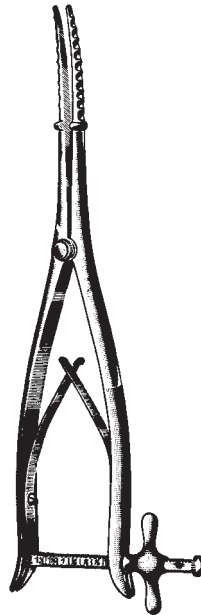

WYLIE  
71443-29  
29 cm, 11 1/2"

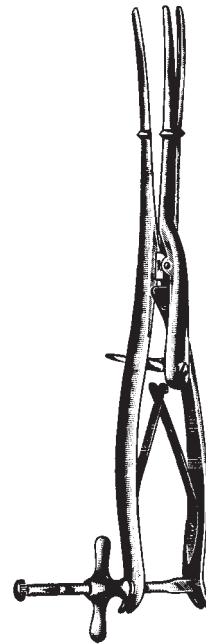

SIMS  
71445-29  
29 cm, 11 1/2"

Hakenzangen

Tenaculum Forceps

Pinzas para coger el cuello del útero

Pinze per abbassare il collo dell'utero



ADAIR  
71500-18  
19 cm, 7 1/2"

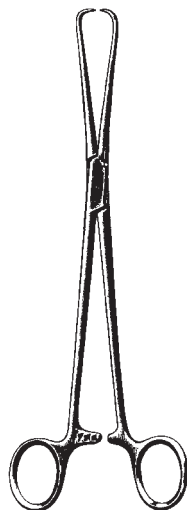

SCHRÖDER (POZZI)  
71502-25  
25 cm, 10"



POZZI-PALMER  
71503-25  
25 cm, 10"

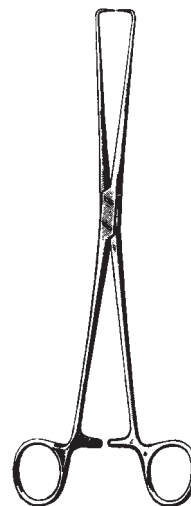

BRAUN  
71504-25  
25 cm, 10"

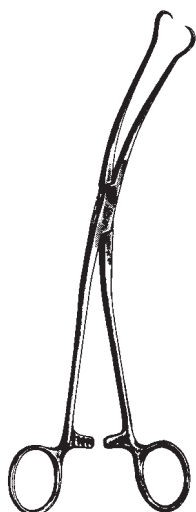

SKENE  
71505-24  
24 cm, 9 1/2"

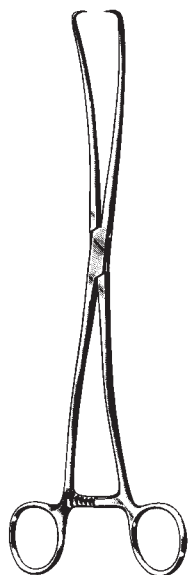

DUPLAY  
71507-28  
28 cm, 11"

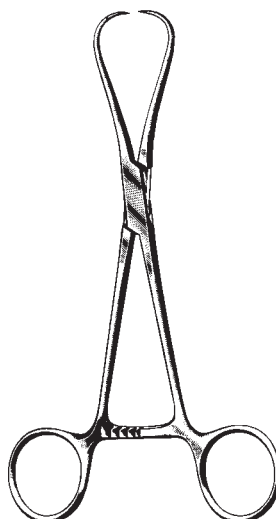

STAUDE-MOORE  
71508-17  
17 cm, 6 3/4"

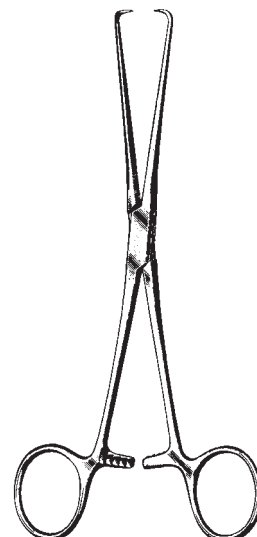

BARRETT  
71510-18  
18 cm, 7"

Hakenzangen  
 Tenaculum Forceps, Vulsellum Forceps  
 Pinzas para coger el cuello del útero  
 Pinze per abbassare il collo dell'utero

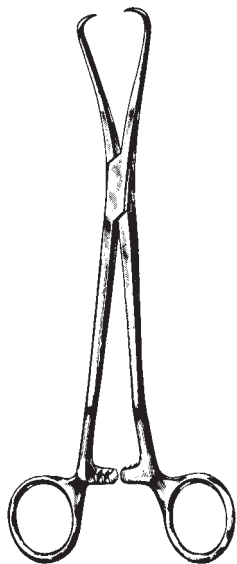

JARCHO  
 71512-20  
 20 cm, 8"

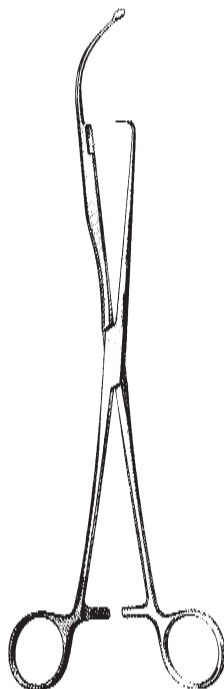

HULKA  
 71512-28  
 28 cm, 11"

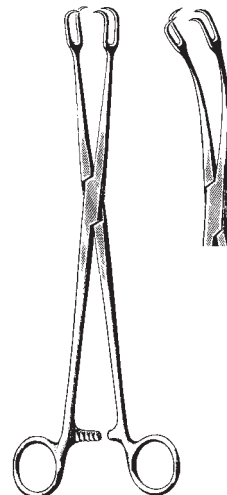

SCHRÖDER  
 71514-24 71515-24  
 24 cm, 9 1/2"

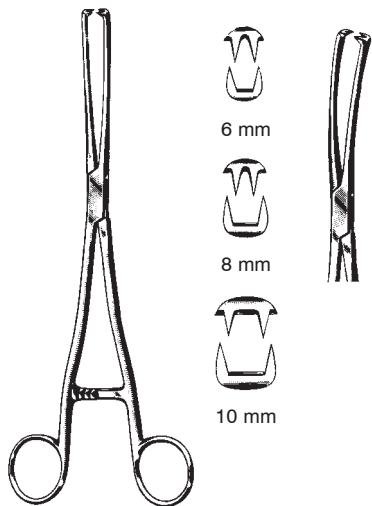

MUSEUX  
 71524-06 6 mm 71525-06  
 71524-08 8 mm 71525-08  
 71524-10 10 mm 71525-10  
 24 cm, 9 1/2"

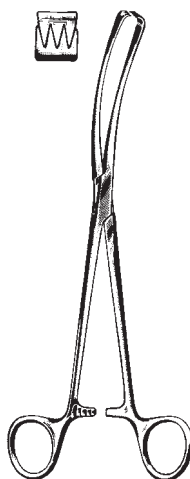

TEALE  
 71531-23  
 23 cm, 9"

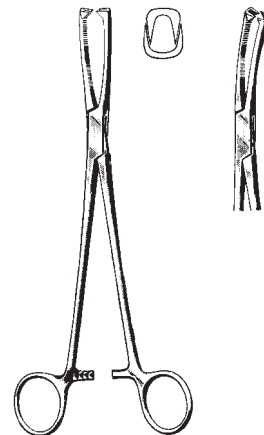

JACOBS  
 71532-21 71533-21  
 21 cm, 8 1/4"

## Hakenzangen

Tenaculum Forceps, Vulsellum Forceps

Pinzas para coger el cuello del útero

Pinze per abbassare il collo dell'utero

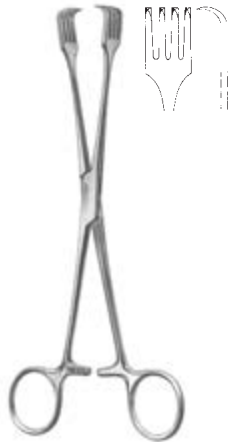

CZERNY  
71536-21  
20 cm, 8"



PRATT  
71536-28  
28 cm, 11"



SCHRÖDER  
71537-27  
27 cm, 10 1/2"

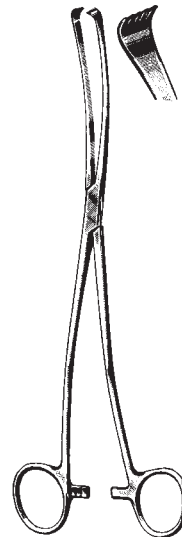

IOWA  
71539-26  
26 cm, 10 1/4"

Uterus Polypenzangen, Uterus-Faßzangen  
 Uterine Polypus Forceps, Uterine Elevating Forceps  
 Pinzas para pólipos uterinos, Pinzas para el útero  
 Pinze per polipi uterini, Pinze per afferrare l'utero

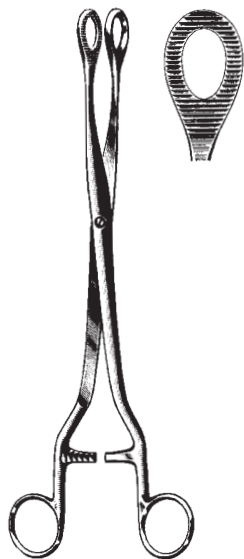

NOTO  
 71540-27  
 27 cm, 10 1/2"

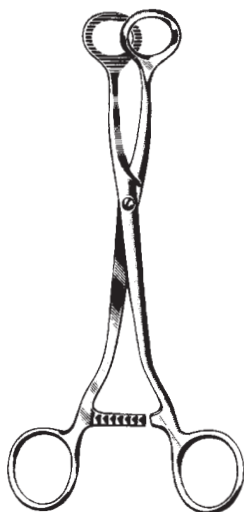

DOYEN  
 71542-20  
 20 cm, 8"

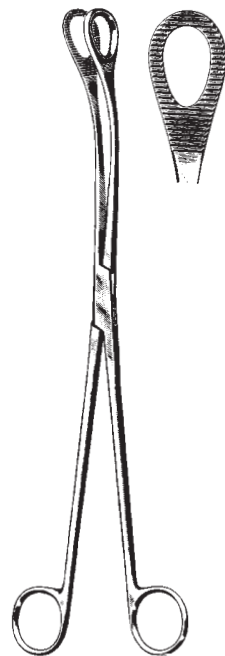

KELLY  
 71543-32  
 32 cm, 12 3/4"



DARTIGUES  
 71545-27  
 27 cm, 10 1/2"



SOMER  
 71547-23  
 23 cm, 9"

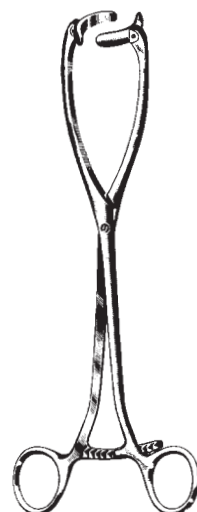

COLLIN  
 71549-25  
 25 cm, 10"

Amniotom, Uterus Depressoren, Uterus-Sonden  
 Amniotome, Uterine Depressors, Uterine Sounds  
 Amniótomo, Depresores uterinos, Histerómetros  
 Amniotomo, Depressori uterini, Isterometri



BEACHAM  
 71559-26  
 26 cm, 10 1/4"



BRAUN  
 71565-28  
 28 cm, 11"



SIMS  
 71567-26  
 26 cm, 10 1/4"



fest  
 rigid  
 rigido  
 rigida

SIMS

71580-32  
 32 cm, 12 3/4"

biegsam  
 malleable  
 maleable  
 malleabile

71581-32



fest  
 rigid  
 rigido  
 rigida

MARTIN

71582-32  
 32 cm, 12 3/4"

biegsam  
 malleable  
 maleable  
 malleabile

71583-32



COLLIN  
 71584-28  
 28 cm, 11"



VALLEIX  
 71585-25  
 25 cm, 10"

Saugküretten, Biopsieküretten  
 Biopsy Curettes  
 Curetas para biopsia  
 Curette per biopsia

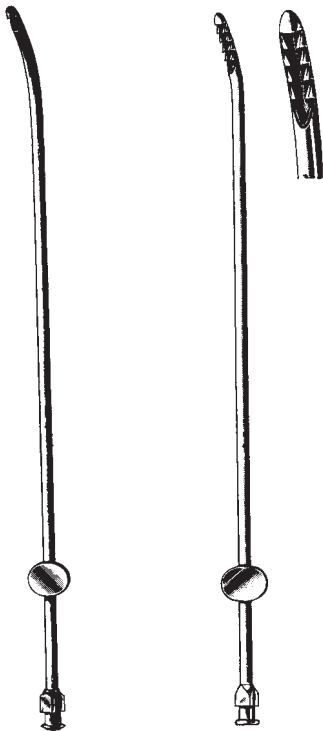

RANDALL  
 71590-04  
 24 cm, 9 1/2"  
 Ø 4 mm

NOVAK  
 71592-01 Ø 1 mm  
 71592-02 Ø 2 mm  
 71592-03 Ø 3 mm  
 71592-04 Ø 4 mm



HEANY  
 71593-00  
 22,5 cm, 9"



71594-40  
 ohne Korb  
 without basket  
 sin cesta  
 senza cestello

71596-40  
 mit Korb  
 with basket  
 con cesta  
 con cestello

KEVORKIAN  
 4,0 mm  
 30 cm, 11 3/4"

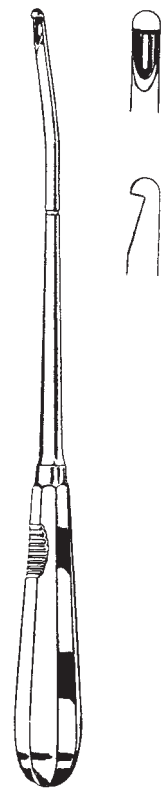

MOD. MUENCHEN  
 71598-27  
 27 cm, 10 1/2"

mit Luer-Lock Ansatz  
 with Luer-Lock connection  
 con conexión Luer-Lock  
 con raccordo Luer-Lock

Biopsiezangen  
 Biopsy Forceps  
 Pinzas para biopsia  
 Pinze taglienti per biopsia



71604-01  
5 mm

71604-02  
7 mm

SCHUMACHER  
24 cm, 9 1/2"



SCHUBERT  
71604-21 21 cm, 8 1/4"  
71604-28 28 cm, 11"



SCHUBERT  
71605-26  
26 cm, 10 1/4"



THOMS-GAYLOR  
71606-24  
24 cm, 9 1/2"



van DOREN  
71611-25  
25 cm, 10"



FAURE  
71612-21  
21 cm, 8 1/4"



Uterus Biopsiezangen  
Biopsy Specimen Forceps  
Pinzas para biopsia  
Pinze per biopsia

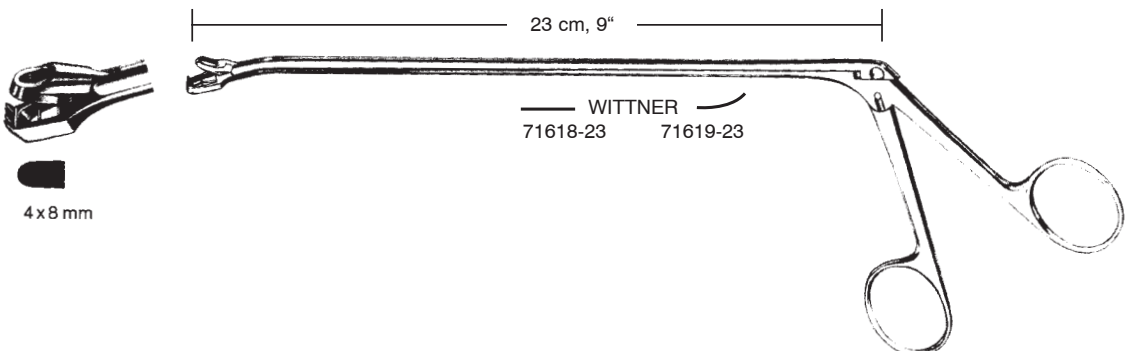
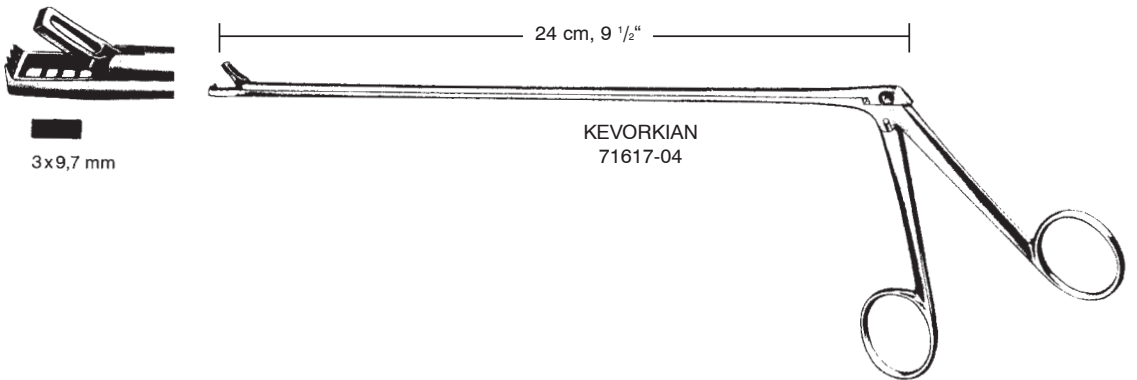
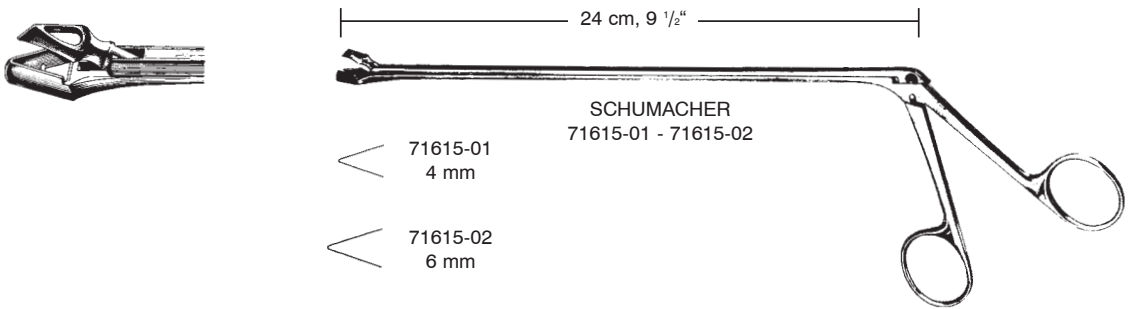
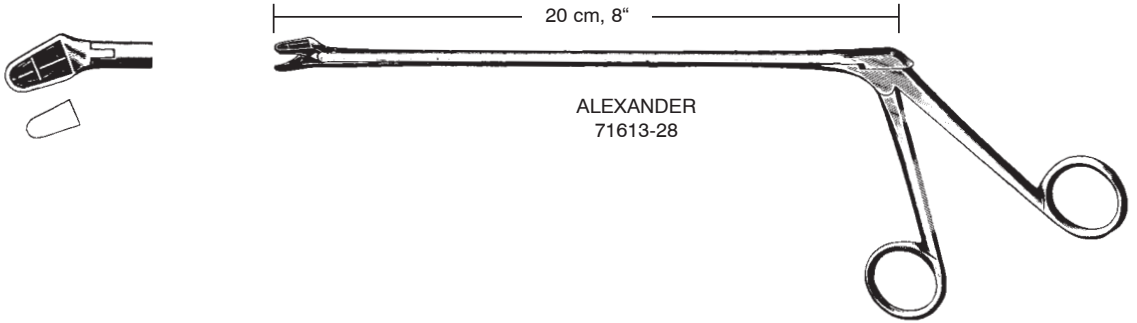

Uterus Biopsiezangen  
 Biopsy Specimen Forceps  
 Pinzas sacabocado p. biopsia  
 Pinze per biopsia

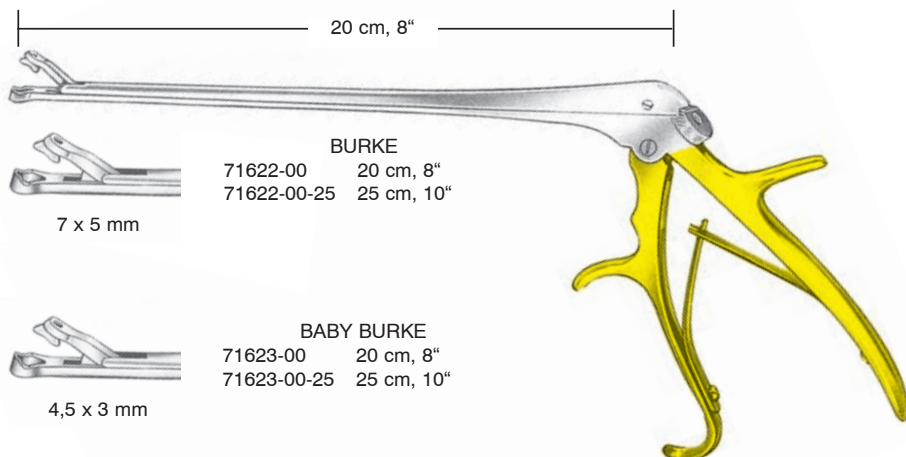
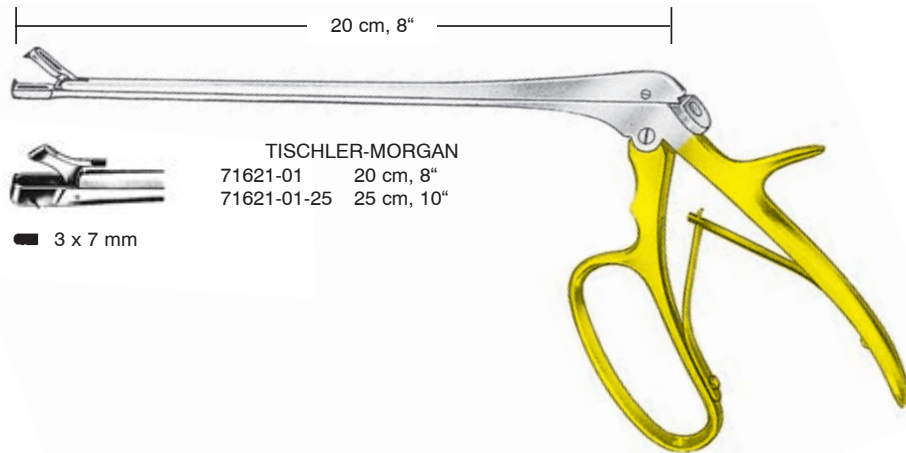
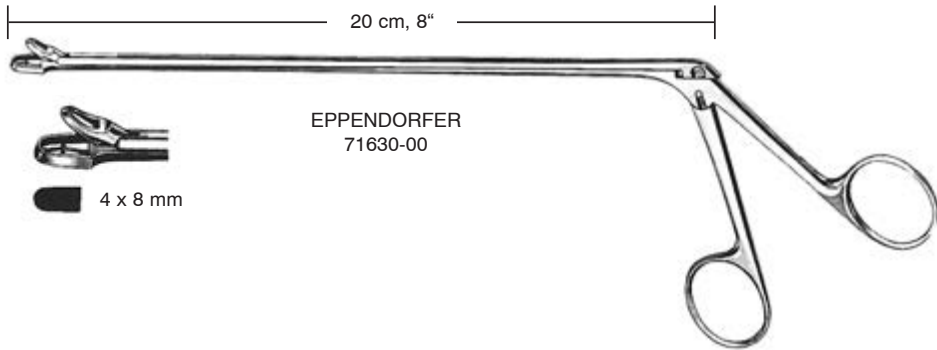

Uterus Biopsiezangen  
 Biopsy Specimen Forceps  
 Pinzas sacabocado p. biopsia  
 Pinze per biopsia

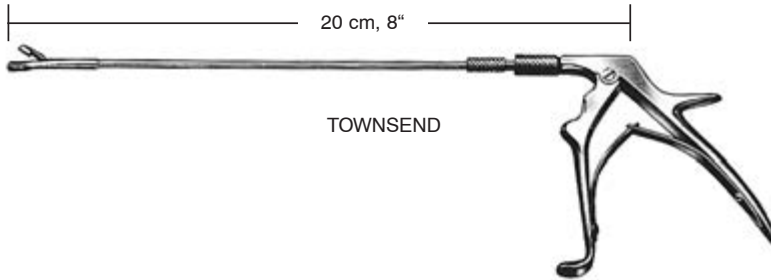

TOWNSEND

71624-10  
 Griff allein  
 Handle only  
 Mango solo  
 Manico solo



Fig. 1

TISCHLER-MORGAN



Fig. 6

TISCHLER-UP



Fig. 3

oval ● 3,7x5 mm



Fig. 7

TISCHLER-DOWN



Fig. 4

KEVORKIAN



Fig. 8

MINI-TOWNSEND-UP



Fig. 5

mini



Fig. 9

MINI-TOWNSEND-DOWN

Fig.	Strumento completo	Asta operativa sola
1	71624-01	71624-11
3	71624-03	71624-13
4	71624-04	71624-14
5	71624-05	71624-15
6	71624-06	71624-16
7	71624-07	71624-17
8	71624-08	71624-18
9	71624-09	71624-19

komplett  
 compl. instr.  
 Instrum. compl.

Aufsatz allein  
 Tip only  
 Punta sola

Uterus Biopsiezangen  
 Biopsy Specimen Forceps  
 Pinzas sacabocado p. biopsia  
 Pinze per biopsia



2,3 x 4,2 mm

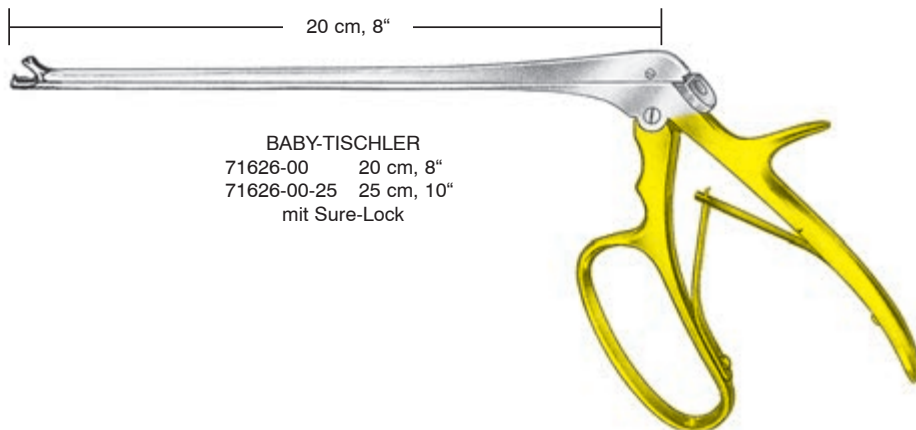

3 x 9,5 mm

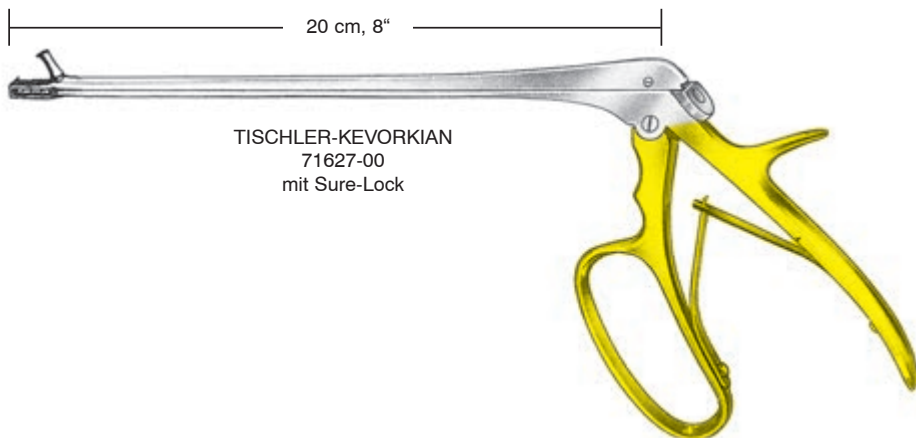

3 x 8 mm

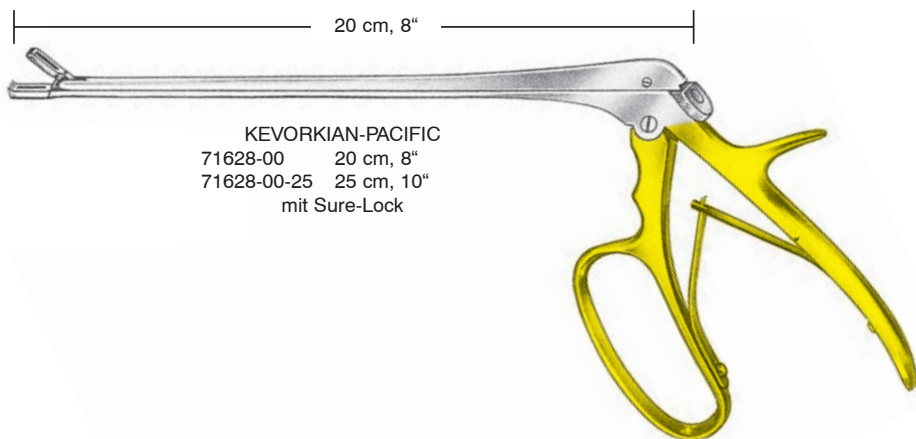

Uterus Biopsiezangen  
Biopsy Specimen Forceps  
Pinzas sacabocado p. biopsia  
Pinze per biopsia

17,5 cm, 6.9"

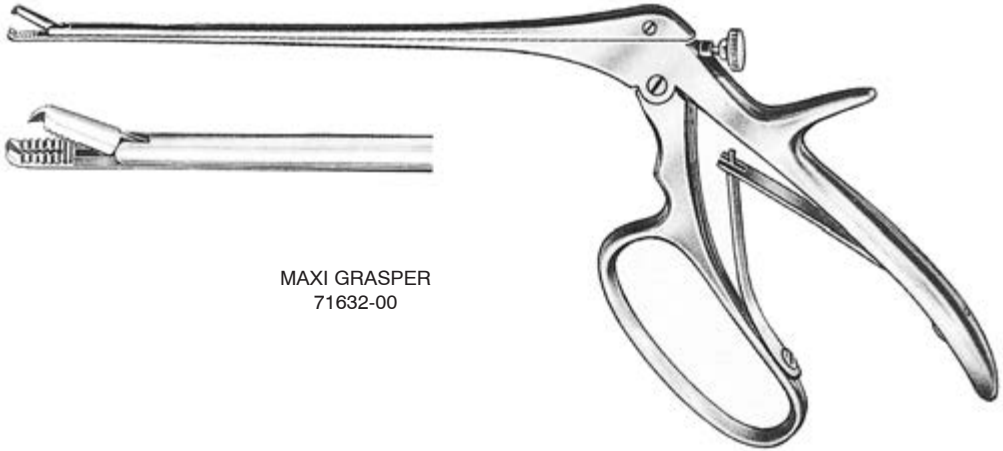

MAXI GRASPER  
71632-00

20 cm, 8"

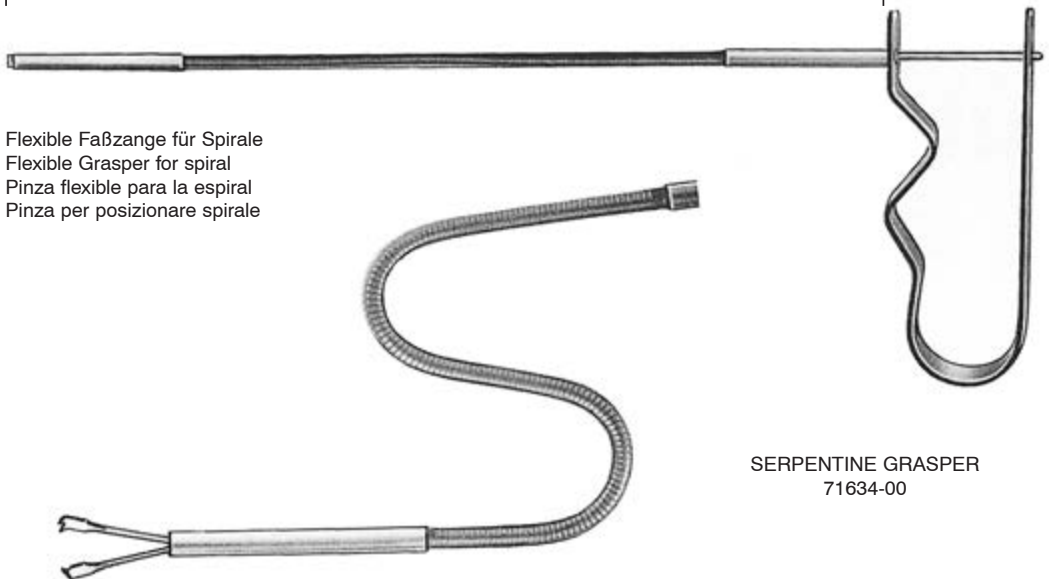

Flexible Faßzange für Spirale  
Flexible Grasper for spiral  
Pinza flexible para la espiral  
Pinza per posizionare spirale

SERPENTINE GRASPER  
71634-00



I.U.D.  
Extractor Hook  
71635-26  
26 cm, 10 1/4"

Myomheber, Myommesser, Fistelhäkchen, Meßinstrumente, Uteruslöffel

Myoma Screw, Myoma Knife, Fistula Hook, Measuring Instruments, Uterine Currettes

Tirabuzón para fibromas, Bisturi para fibromas, Ganchos para fistulas, Instrumental para medir, Curetas uterinas

Tiramiomi, Bisturi per fibromi, Uncini per fistole, Strumenti per misure, Curette uterine

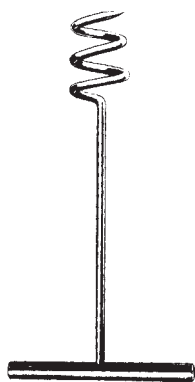

DOYEN  
71641-17  
17 cm, 6 3/4"

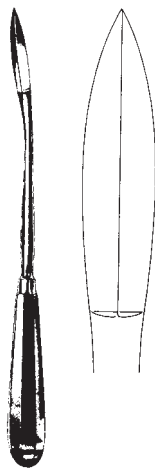

SEGOND  
71643-27  
27 cm, 10 1/2"

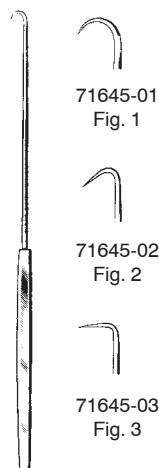

EMMET  
71645-01 - 71645-03  
22 cm, 8 3/4"

71645-01  
Fig. 1

71645-02  
Fig. 2

71645-03  
Fig. 3



71646-01

71646-02

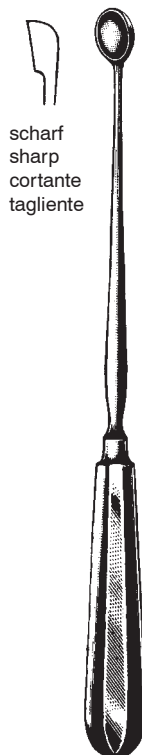

scharf  
sharp  
cortante  
tagliente

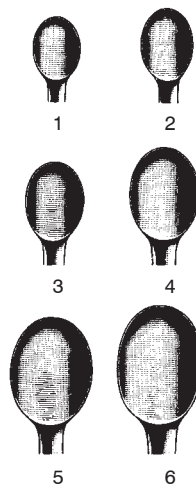

Fig. SIMON  
1 71702-01 6,8 mm  
2 71702-02 8,5 mm  
3 71702-03 10,0 mm  
4 71702-04 11,5 mm  
5 71702-05 13,0 mm  
6 71702-06 14,5 mm  
25 cm, 10"

Uterus-Küretten  
 Uterine Currettes  
 Curetas uterinas  
 Curette uterine



SCHRÖDER  
 31 cm, 12 1/4"



scharf/stumpf  
 sharp/blunt  
 cortante/roma  
 tagliente/smussa



BLAKE  
 71704-27  
 27 cm, 10 1/2"

Salpingograph  
Salpingograph  
Salpingógrafo  
Salpingografo

**71650-00**

SCHULTZE Salpingograph bestehend aus:

- 71650-01 1 Tubenkatheter
- 71650-02 1 Zwischenstück
- 71650-03 1 Manometer
- 71650-04 1 Kegel, klein
- 71650-05 1 Kegel, mittel
- 71650-06 1 Kegel, groß
- 71650-07 1 Recordspritze mit Luer-Lock Ansatz 10cc

SCHULTZE salpinogograph compl.:

- 71650-01 1 Tubal catheter only
- 71650-02 1 connecting piece
- 71650-03 1 manometer
- 71650-04 1 cone small
- 71650-05 1 cone medium
- 71650-06 1 cone large
- 71650-07 1 syringe record with Luer-Lock 10cc

Salpingógrafo compuesto de:

- 71650-01 1 cateter de tubo
- 71650-02 1 pieza de conexion
- 71650-03 1 manometro
- 71650-04 1 cono pequeño
- 71650-05 1 cono mediano
- 71650-06 1 cono grande
- 71650-07 1 jeringa con conexión Luer-Lock 10cc

Salpingografo composto da:

- 71650-01 1 Catetere per tubo
- 71650-02 1 Raccordo
- 71650-03 1 Manometro
- 71650-04 1 Cono, piccolo
- 71650-05 1 Cono, medio
- 71650-06 1 Cono, grande
- 71650-07 1 Siringa record con raccordo Luer-Lock 10cc

71660-00  
Schultze Salpingograph, jedoch ohne Manometer

Schultze Salpingograph without manometer

Schultze Salpingografo sin manometro

Schultze Salpingografo senza manometro

71650-06

71650-05 71650-04

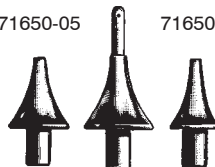

71650-07

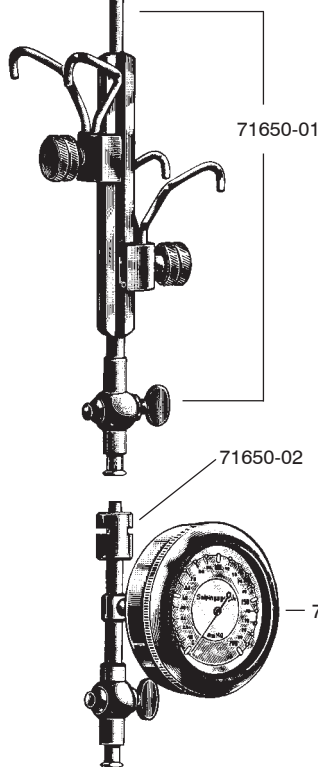
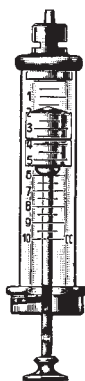

SCHULTZE  
71650-00  
compl.

im Etui  
in case  
en estuche  
in astuccio



Uterus-Küretten  
 Uterine Curettes  
 Curetas uterinas  
 Curette Uterine

**SIMS**

71710-05 - 71717-14  
28 cm, 11"

	scharf sharp cort. tagl.	Fig.	mm	stumpf blunt roma smussa
fest	71710-05	00	5,0	71715-05
rig.	71710-06	0	6,0	71715-06
	71710-07	1	7,5	71715-07
	71710-08	2	8,5	71715-08
	71710-09	3	10,0	71715-09
	71710-11	4	11,5	71715-11
	71710-12	5	13,5	71715-12
	71710-14	6	14,5	71715-14

**RECAMIER**

71720-05 - 71727-20  
31 cm, 12 1/4"

	scharf sharp cort. tagl.	Fig.	mm	stumpf blunt roma smussa
fest	71720-05	00	5	71725-05
rig.	71720-06	0	6	71725-06
	71720-07	1	7	71725-07
	71720-08	2	8	71725-08
	71720-09	3	9	71725-09
	71720-11	4	11	71725-11
	71720-12	5	12	71725-12
	71720-14	6	14	71725-14
	71720-15	7	15	71725-15
	71720-16	8	16	71725-16
	71720-19	9	19	71725-19
	71720-20	10	20	71725-20

**BUMM**

71730-30 - 71737-40  
35 cm, 13 3/4"

	scharf sharp cort. tagl.	Fig.	stumpf blunt roma smussa
fest	71730-30	14	71735-30
rig.	71730-35	15	71735-35
	71730-40	16	71735-40

flexibel	71712-05	00	5,0	71717-05
flexible	71712-06	0	6,0	71717-06
fless.	71712-07	1	7,5	71717-07
	71712-08	2	8,5	71717-08
	71712-09	3	10,0	71717-09
	71712-11	4	11,5	71717-11
	71712-12	5	13,5	71717-12
	71712-14	6	14,5	71717-14

flexibel	71722-05	00	5	71727-05
flexible	71722-06	0	6	71727-06
fless.	71722-07	1	7	71727-07
	71722-08	2	8	71727-08
	71722-09	3	9	71727-09
	71722-11	4	11	71727-11
	71722-12	5	12	71727-12
	71722-14	6	14	71727-14
	71722-15	7	15	71727-15
	71722-16	8	16	71727-16
	71722-19	9	19	71727-19
	71722-20	10	20	71727-20

flexibel	71732-30	14	71737-30
flexible	71732-35	15	71737-35
fless.	71732-40	16	71737-40

Uterus-Küretten  
 Uterine Curettes  
 Curetas uterinas  
 Curette uterine

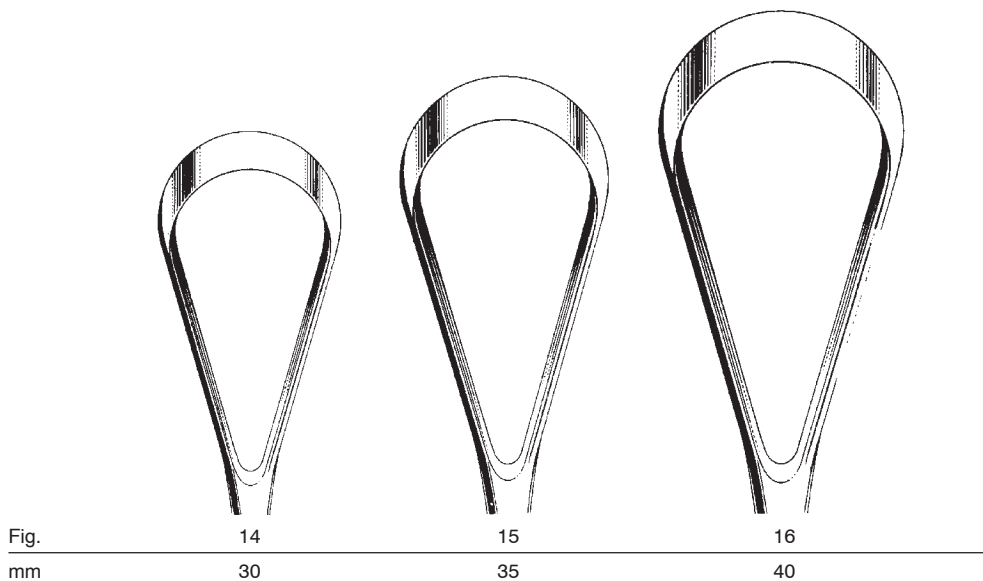
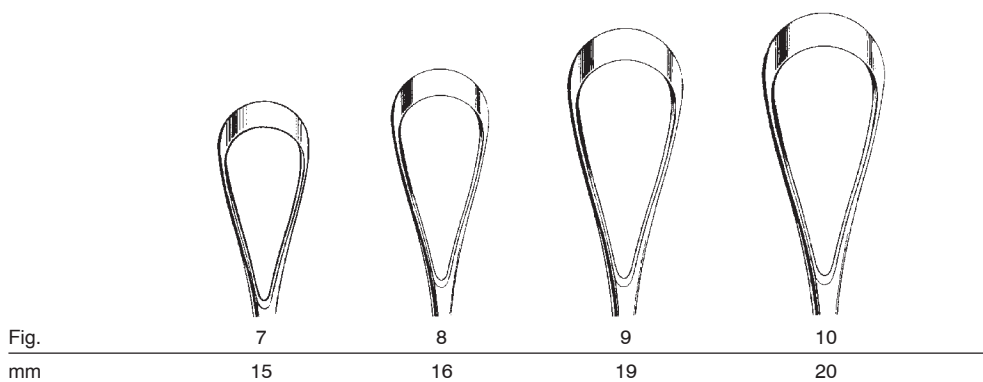
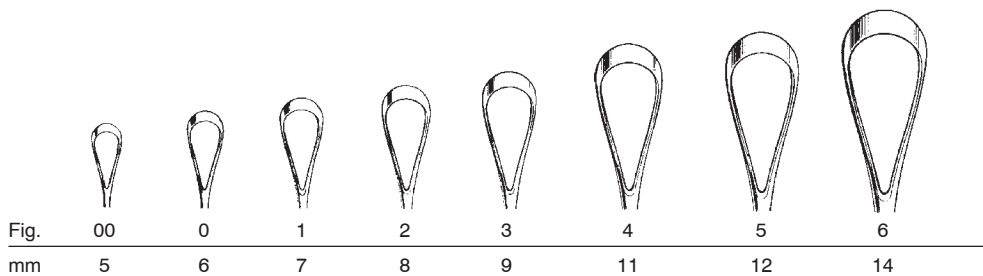

SIMS  
 RECAMIER  
 BUMM  
 71710-05 - 71735-28

Uterus-Küretten  
 Uterine Curettes  
 Curetas uterinas  
 Curette uterine

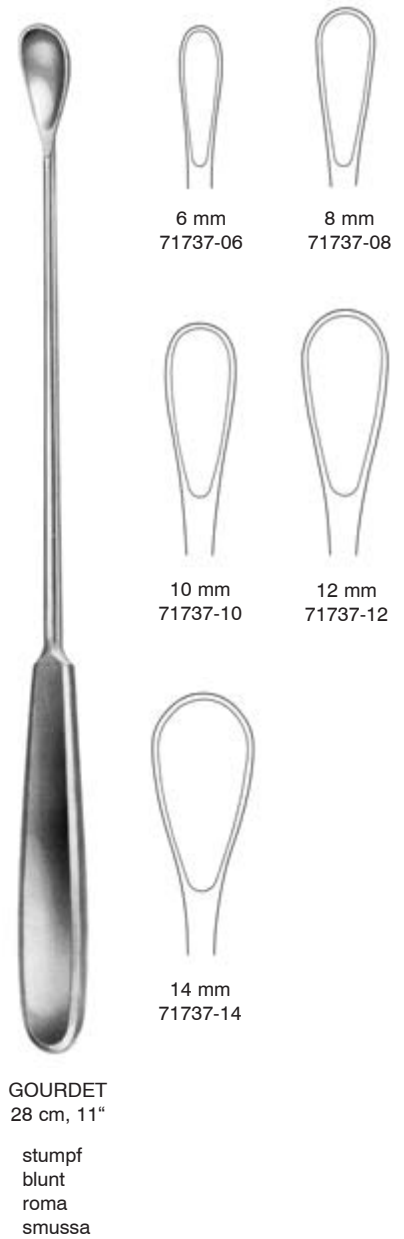
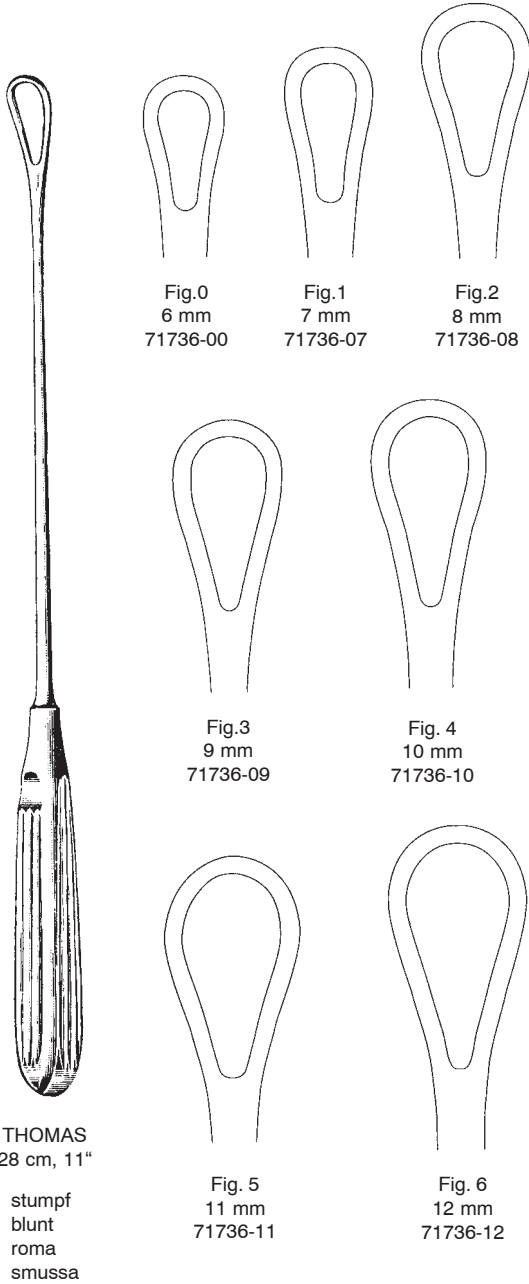

Biopsie- und Absaugküretten, Schlauch-Verbindungsstück  
 Specimen and Aspirating Curettes, Hose connecting piece  
 Curetas para biopsia y aspiración, Pieza conexión para tubos  
 Curette di aspirazione per biopsia, Raccordo di connessione per tubi

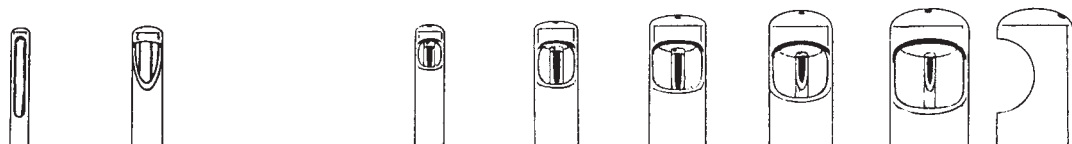

71803-03  
3 mm Ø

71803-04  
4,5 mm Ø

71803-06  
6 mm Ø

71803-08  
8 mm Ø

71803-10  
10 mm Ø

71803-12  
12 mm Ø

71803-14  
14 mm Ø



71803-15

Amnioskope  
Amnioscope  
Amnioscopio  
Amnioscopio



71810-12 12 x 24 mm Ø 20 cm, 8"  
71810-16 16 x 24 mm Ø 20 cm, 8"  
71810-20 20 x 24 mm Ø 20 cm, 8"



71810-50  
Kaltlichtklammer  
Cold Light clamp  
Adaptador de iluminacion  
Adattore di illuminazione

Geburtszangen  
Obstetrical Forceps  
Forceps obstétricos  
Forcipi

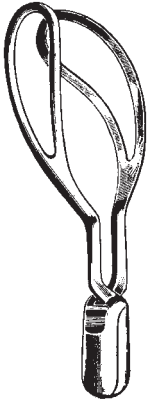

WRIGLEY  
73101-23  
23 cm, 9"



SIMPSON  
73102-30  
30 cm, 11 3/4"

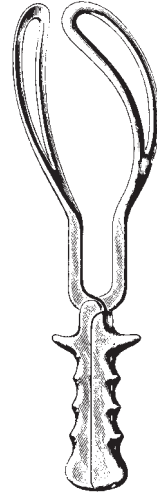

SIMPSON-BRAUN  
73105-33 33 cm, 13"  
73105-36 36 cm, 14"

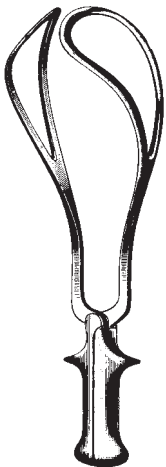

De LEE  
73107-30  
30 cm, 11 3/4"



De LEE  
73108-36 36 cm, 14"  
73108-39 39 cm, 15 1/2"

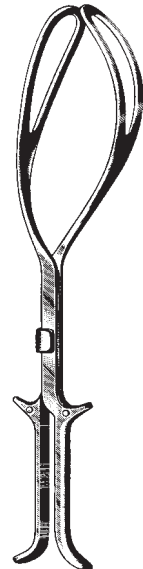

KIELLAND  
73110-41  
41 cm, 16"

Geburtszangen  
 Obstetrical Forceps  
 Forceps obstétricos  
 Forcipi

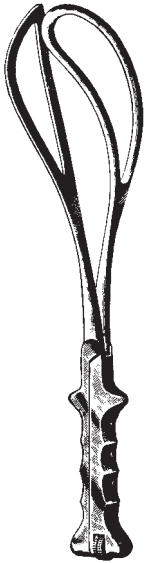

ELLIOT  
 73115-32 32 cm, 12 3/4"  
 73115-38 38 cm, 15"

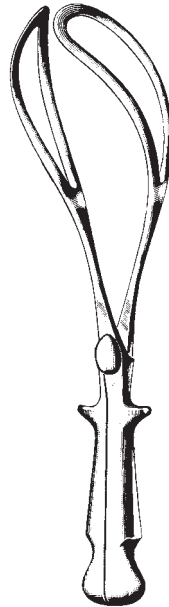

NAEGELE  
 73119-36 36 cm, 14"  
 73119-40 40 cm, 15 3/4"



THIERRY  
 73123-39 39 cm, 15 1/2"

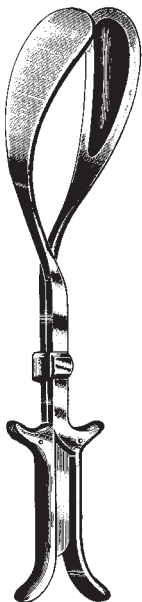

LUIKART  
 73125-40  
 40 cm, 15 3/4"

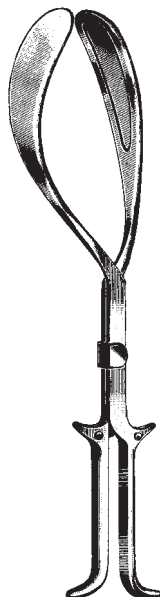

KIELLAND-LUIKART  
 73127-40  
 40 cm, 15 3/4"

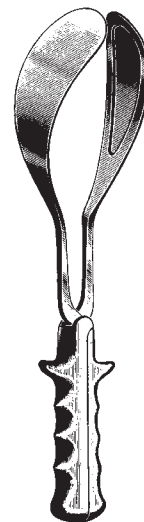

SIMPSON-LUIKART  
 73135-36  
 36 cm, 14"

Geburtszangen  
Obstetrical Forceps  
Forceps obstétricos  
Forcipi

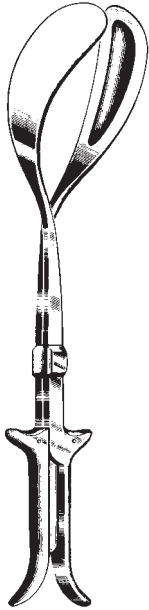

McLEAN-TUCKER-LUIKART  
73139-40  
40 cm, 15 <sup>3</sup>/<sub>4</sub>"

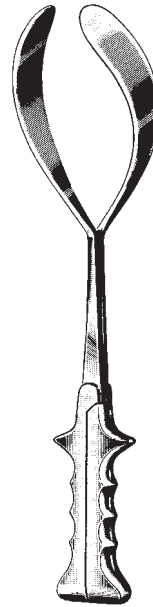

McLEAN-TUCKER  
73141-39  
39 cm, 15 <sup>1</sup>/<sub>2</sub>"



McLEAN-LUIKART  
73143-39  
39 cm, 15 <sup>1</sup>/<sub>2</sub>"

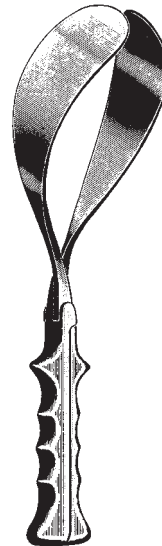

McLEAN  
73145-36  
36 cm, 14"



Geburtszangen, Zughebel  
Obstetrical Forceps, Traction Handle  
Forceps obstétricos, Dispositivos de tracción  
Forcipi, Leve per trazione

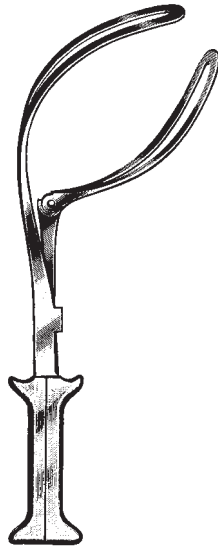

BARTON  
73147-36  
36 cm, 14"

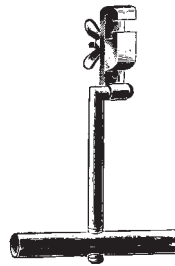

BARTON  
73148-17  
17 cm, 6 <sup>3</sup>/<sub>4</sub>"

Geburtszangen, Zughebel  
 Obstetrical Forceps, Traction handles  
 Forceps obstétricos, Dispositivos de tracción  
 Forcipi, Leve per trazione

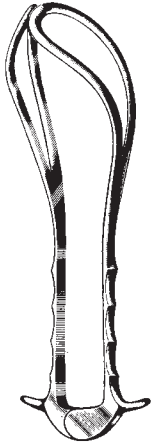

BOERMA  
 73151-29  
 29 cm, 11 1/2"

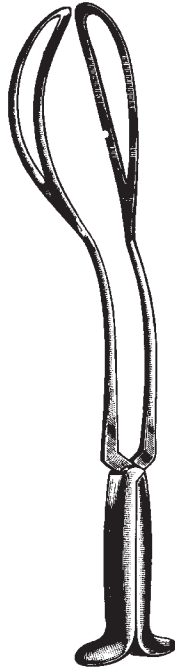

PIPER  
 73155-44  
 44 cm, 17 1/4"

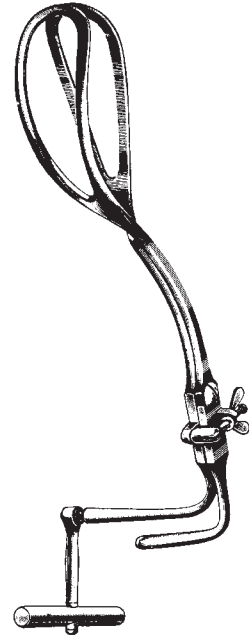

PIPER  
 73157-40  
 40 cm, 15 3/4"

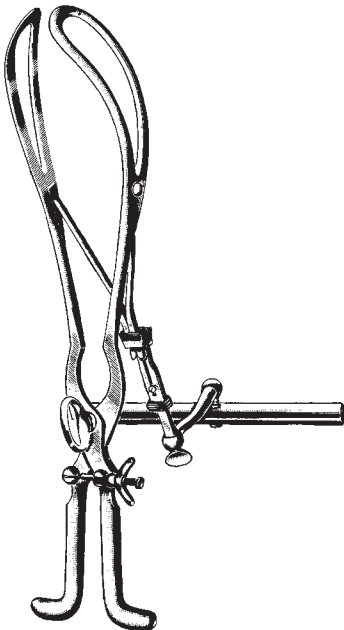

TARNIER  
 73162-40  
 40 cm, 15 3/4"

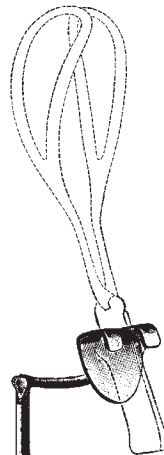

BILL  
 73170-00  
 21 cm, 8 1/4"

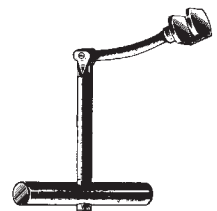

LUIKART-BILL  
 73171-21  
 21 cm, 8 1/4"

Geburtshaken, Kopfschwartzangen, Uterus-Klemmzange, Nabelschnurklemmen, Beckenzirkel  
 Scalp flap forceps, Uterine haemostatic forceps, Umbilical cord clamps, Pelvimeters  
 Pinzas para cuero cabelludo, Pinzas-clamps uterinas para hemóstasis, Clamp umbilical, Pelvímetros  
 Pinza per il cuoio capelluto, Pinza uterina, Pinza ombelicale, Pelvimetri



**SPELLIE**  
 73181-33  
 33 cm, 13"

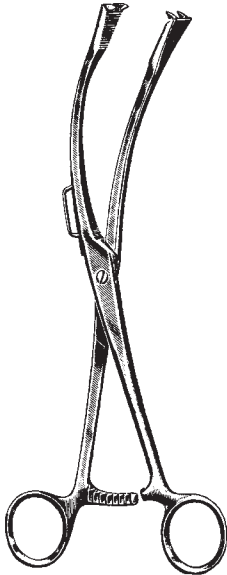

**GAUSS**  
 73183-27  
 27 cm, 10 1/2"



**GREEN-ARMYTAGE**  
 73184-21  
 21 cm, 8 1/4"

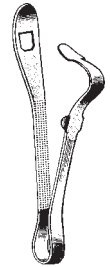

**COLLIN**  
 73187-09  
 9 cm, 3 1/2"

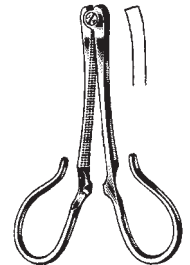

**KANE**  
 73189-09  
 8,5 cm, 3 1/4"

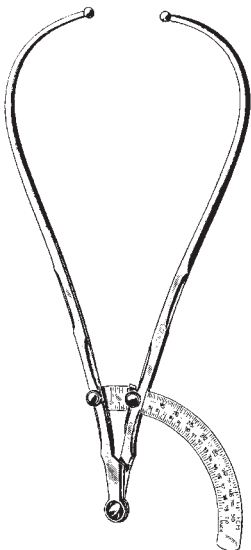

**MARTIN**  
 73191-34  
 34 cm, 13 1/2"

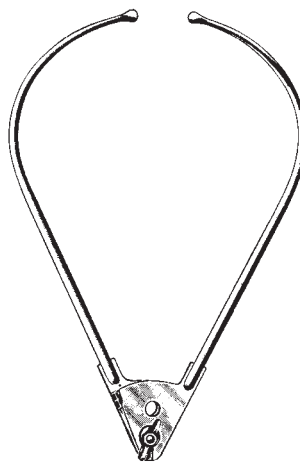

**COLLIER**  
 73193-30  
 30 cm, 11 3/4"

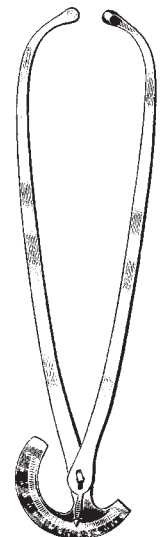

**COLLIN**  
 73195-35  
 35 cm, 14"



Abortuslöffel, Geburtslöffel, Kranioklast, Basiotrip, Perforatorium, Dekapitationshaken  
 Abortion Scoops, Elevating Spoon, Cranioclast, Basiotribe, Perforators, Decapitating hook  
 Cucharillas para aborto, Separador obstetrico, Craneoclasto, Basiotribo, Perforacráneos, Gancho para decapitación  
 Curette per aborto, Cucchio Ostetrico, cranioclasto, Basiotribo, spezzacrani, Uncino per decapitazione



stumpf  
 blunt  
 roma  
 smussa



WALLICH  
 73256-42  
 42 cm, 16 1/2"



SELLHEIM  
 73259-28  
 28 cm, 11"

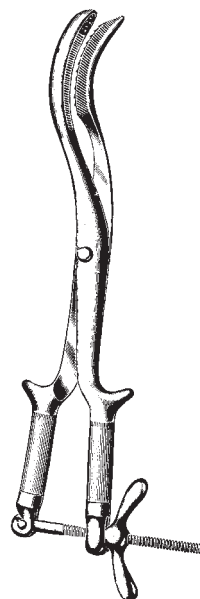

BRAUN  
 73302-42  
 42 cm, 16 1/2"



TARNIER  
 73304-46  
 46 cm, 18"

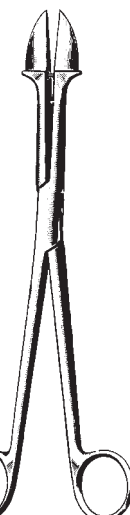
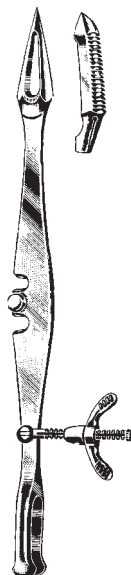

SMELLIE  
 73306-25  
 25 cm, 10"



BRAUN  
 73309-30  
 30 cm, 11 3/4"

Hauthäkchen, Komedonenquetscher, Lupusküretten, Hautküretten, Haut-Trephinen  
 Skin hooks, Comedone extractors, Lupus curettes, Skin curettes, Cutaneous punches  
 Ganchos cutáneos, Saca comedones, Curetas para lupus, Curetas cutáneas, Trépanos cutáneos  
 Uncini cutanei, Schiaccia comedoni, Curette per lupus, Curette cutanee, Trefine cutanee



**KILNER**  
75103-15  
15 cm, 6"



**SCHAMBERG**  
75111-10  
10 cm, 4"

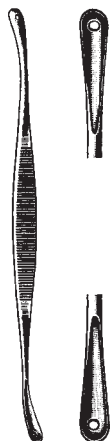

**UNNA**  
75113-14  
14 cm, 5 1/2"



**UNNA**  
75115-14  
14 cm, 5 1/2"



**WALTON**  
75118-14  
14 cm, 5 1/2"



**SAALFELD**  
75121-10  
10 cm, 4"

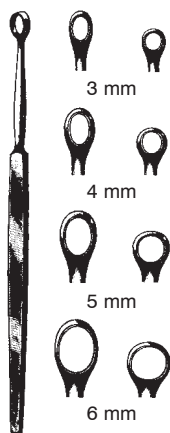

14 cm, 5 1/2"

FOX		FOX	
75128-01	1 mm	75129-01	1 mm
75128-02	2 mm	75129-02	2 mm
75128-03	3 mm	75129-03	3 mm
75128-04	4 mm	75129-04	4 mm
75128-05	5 mm	75129-05	5 mm
75128-06	6 mm	75129-06	6 mm



**PIFFARD**  
14,5 cm, 5 3/4"  
75130-01 Fig. 1  
75130-02 Fig. 2  
75130-03 Fig. 3



**75138-00**  
Satz komplett mit 6 Aufsätzen  
Set complete with 6 tips  
Juego con 6 puntas  
Serie completa con 6 trefini



**KEYES**  
10 cm, 4"  
75140-02 2 mm  
75140-03 3 mm  
75140-04 4 mm  
75140-05 5 mm  
75140-06 6 mm  
75140-07 7 mm  
75140-08 8 mm



Nagelzangen, -Scheren  
Nail Nippers, Scissors  
Alicates corta-uñas  
Tronchesini forbici per unghie



75301-10

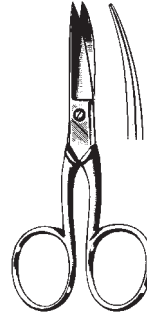

75304-10 10 cm, 4" 75305-10



75331-14  
14 cm, 5 1/2"  
stainless



TURNBULL  
75341-11 11,5 cm, 4 1/2"  
75341-13 13,5 cm, 5 1/4"  
stainless

Nagelhautzangen, Hautscheren, Nagelfeilen  
Cuticle Nippers, Cuticle Scissors, Nail Files  
Pinzas y Tijeras cuticulares, Limas para uñas  
Tronchesine per unghie e pelle, Limette per le unghie



75373-10  
10,5 cm, 4"

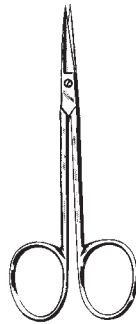

75378-10  
10 cm, 4"

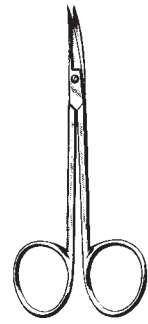

75379-10  
10 cm, 4"



75382-16



Bürstenspender, Handwaschbürsten  
Brush Dispensor, Nail brushes  
Dispensador de cepillos, Cepillo para uñas  
Distributore di spazzole, Spazzole per unghie

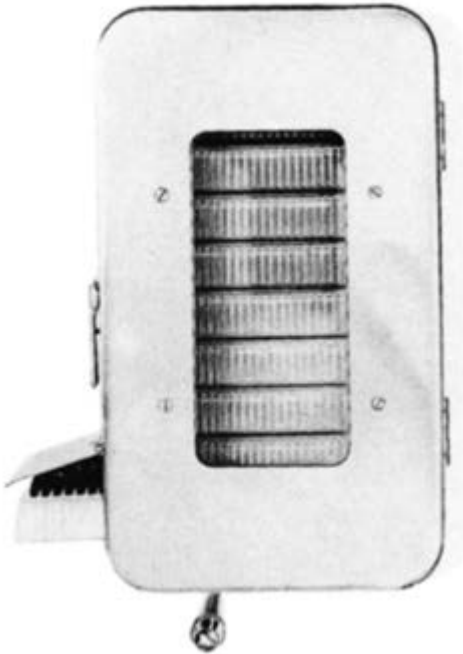

75396-01  
Bürstenspender für 10 Bürsten  
Brush dispenser for 10 brushes  
Distribuidor de cepillos para 10 cepillos  
Distributore per spazzolini da 10

75396-02  
Bürstenspender für 20 Bürsten  
Brush dispenser for 20 brushes  
Distribuidor de cepillos para 20 cepillos  
Distributore per spazzolini da 20

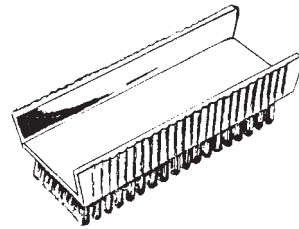

75397-00

Pack. à 10 St.  
Box of 10 pcs  
caja de 10 pzas.  
confezione da 10 pezzi

Hygiene  
Hygiene  
Higiene  
Igiene



PROBE AND PACKER  
75450-00  
14,5 cm, 5 <sup>3</sup>/<sub>4</sub>"



SPATULA AND PACKER  
75440-00  
14,5 cm, 5 <sup>3</sup>/<sub>4</sub>"



mit Loch, with hole,  
con agujero, con foro

75430-12 = 1,5 mm + 2 mm  
75430-13 = 1,5 mm + 2,5 mm  
14,5 cm, 5 <sup>3</sup>/<sub>4</sub>"



14,5 cm, 5 <sup>3</sup>/<sub>4</sub>"  
ohne Loch, without hole,  
sin agujero, senza foro

75400-01 = 1 mm  
75400-02 = 1,5 mm  
75400-03 = 2 mm  
75400-04 = 2,5 mm

mit Loch, with hole,  
con agujero, con foro

75410-01 = 1 mm  
75410-02 = 1,5 mm  
75410-03 = 2 mm  
75410-04 = 2,5 mm

Hygiene  
Hygiene  
Higiene  
Igiene

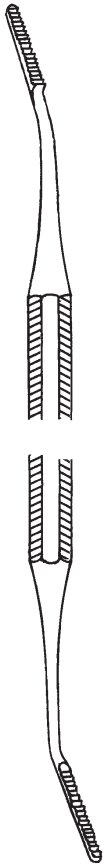

75410-15  
17,5 cm, 6<sup>3</sup>/<sub>4</sub>"



75420-15  
15 cm, 6"



75430-01  
12,5 cm, 5"



75440-11  
11,5 cm, 4<sup>1</sup>/<sub>2</sub>"



INGROWN  
75445-12  
12,5 cm, 5"

Nagelzangen  
Nail Nippers  
Alicates corta-uñas  
Tronchesini per unghie

stainless steel

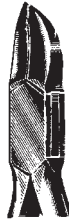

75450-13  
concave



75460-13  
gerade  
straight  
recto  
retta



14,5 cm, 5 3/4"

stainless steel



75470-11  
10 cm  
4"

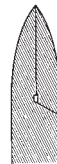

75475-11  
11,5 cm  
4 1/2"

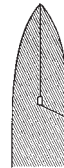

75480-13  
12,5 cm  
5"

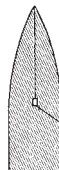

fine  
75485-13  
12,5 cm  
5"

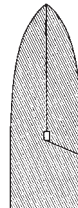

75490-15  
15 cm  
6"

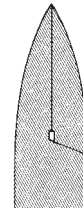

fine  
75500-15  
15 cm  
6"

Nagelzangen  
 Nail Nippers  
 Alicates corta-uñas  
 Tronchesini per unghie

stainless steel

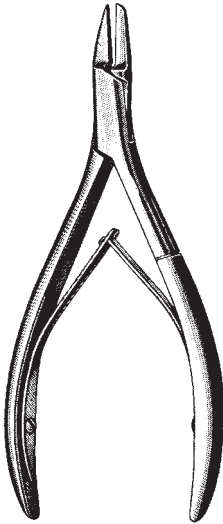

ANVIL  
 75550-13  
 13 cm, 5 1/8"

stainless steel

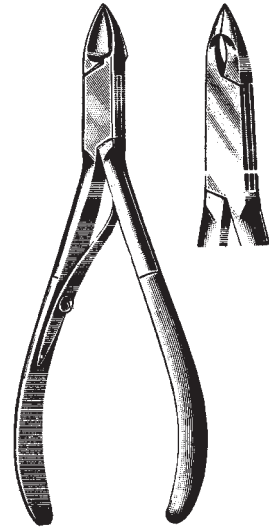

75600-10  
 10 cm, 4"

stainless steel



75618-15  
 15,2 cm, 6"

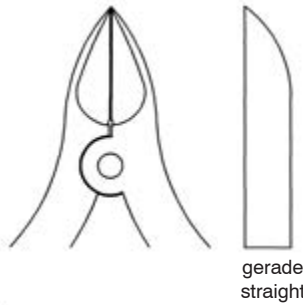

stainless steel

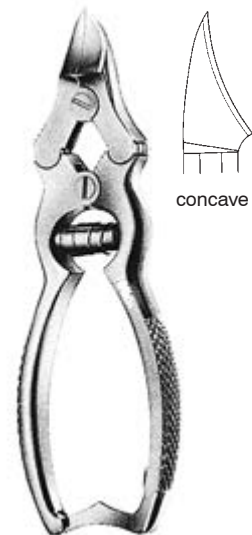

75620-15  
 15,5 cm, 6"

concave

Nagelzangen, Nagelspaltscheren  
Nail Nippers, Nail splitting scissors  
Alicates corta-uñas, Tijeras para hender uñas  
Tronchesini per unghie, Forbici per staccare unghie



75630-12  
12 cm, 4<sup>3</sup>/<sub>4</sub>"



75640-15  
15 cm, 6"

Kappenzangen, Nadel-Sterilisierkästen  
 Sterilizing Forceps, Needle Sterilizing cases  
 Combinacion tapa-pinza, Estuches para esterilizar agujas  
 Pinza coperchio, Scatole per sterilizzare aghi

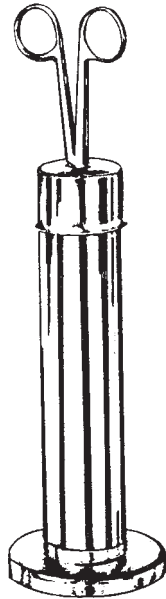

89111-25 25 cm, 10"  
 89111-32 32 cm, 12<sup>3</sup>/<sub>4</sub>"



89112-65  
 65 x 15 mm



89113-65



89114-00  
 150 x 95 x 13 mm



89115-50 50 x 25 x 4,5 mm  
 89115-65 65 x 42 x 8,0 mm  
 89115-75 75 x 25 x 4,5 mm



89116-50 50 x 25 x 4,5 mm  
 89116-65 65 x 42 x 8,0 mm  
 89116-75 75 x 25 x 4,5 mm





Instrumentenkästen  
Instrument Boxes  
Cajas para instrumentos  
Scatole per strumenti



Abmessungen in mm  
Sizes in mm  
tamaños en mm  
misura in mm

l x b x h mm	
400x200x80	89121-40
500x270x70	89121-50

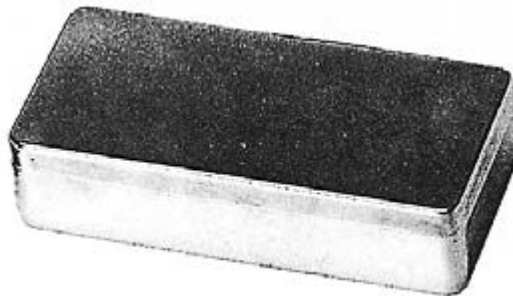

Abmessungen in mm	Deckel ohne Knopf
Sizes in mm	lid without knob
tamaños en mm	tapa sin botón
misura in mm	coperchio senza bottone

l x b x h mm	
165x 85x35	89122-16
200x100x50	89122-21
260x150x50	89122-26
300x200x50	89122-30

Bereitschaftskästen  
Storage cases  
Cajas para almacenaje  
Scatole per magazzinaggio



Abmessungen in mm (l x b x h)  
Sizes in mm (l x b x h)  
tamaños en mm (l x f x a)  
misura in mm (l x l x a)

230 x 130 x 50  
260 x 150 x 50  
275 x 235 x 50  
300 x 200 x 50  
325 x 275 x 50  
420 x 175 x 50

230 x 130 x 75  
260 x 150 x 75  
300 x 200 x 75  
325 x 275 x 75  
420 x 175 x 75

Behälter  
Containers  
Recipientes  
Recipienti

89124-23  
89124-26  
89124-27  
89124-30  
89124-32  
89124-42

89125-23  
89125-26  
89125-30  
89125-32  
89125-42

Satz Spezialfilter (5 Paar)  
Set of spezial filters (5 pairs)  
Juego de filtros especiales (5 pares)  
Set die 5 paia di filtri speciali

89126-23  
89126-26  
89126-27  
89126-30  
89126-32  
89126-42

89127-23  
89127-26  
89127-30  
89127-32  
89127-42

Schüsseln  
Bowls  
Cubetas  
Scondelle

18/10  
Stainless Steel  
Acero inoxidable  
Acciajo inossidabile

matt  
satin finish  
pulidas mate  
opaco



Abmessungen in mm sizes in mm Tamaños en mm misura in mm Ø x h	Inhalt capacity capacidad capacità l	
40x19	0,05	89127-04
61x30	0,07	89127-06
80x40	0,14	89127-08
116x50	0,35	89127-11
128x55	0,45	89127-12
147x65	0,70	89127-14
167x75	1,10	89127-16
187x85	1,60	89127-18

Abmessungen in mm sizes in mm Tamaños en mm misura in mm Ø x h	Inhalt capacity capacidad capacità l	
100x30	0,15	89129-11



	mm x mm	l
89133-16	165 x 60	0,75
89133-17	175 x 70	1,00
89133-22	220 x 80	2,00
89133-24	240 x 110	3,00
89133-31	310 x 120	6,00
89133-34	345 x 125	8,50
89133-38	380 x 130	11,00

89139-17	170 x 100 x 35 mm	0,50 l
89139-25	250 x 140 x 40 mm	1,25 l
89139-27	275 x 150 x 45 mm	2,25 l

Meßbecher, Dose, Standgefäß, Mehrzweckschalen  
 Graduated Measures, Box, Jars, Universal Trays  
 Copas graduadas, Recipientes, Tarros, Bandejas para instrumentos  
 Bicchieri graduati, Recipienti, Recipienti cilindrici, Bacinelle per strumenti

18/10  
 Stainless Steel  
 Acero inoxidable  
 Acciajo inossidabile

matt  
 satin finish  
 pulidas mate  
 opaco



l	
0,25	89140-02
0,5	89140-05
1,0	89140-10
2,0	89140-20



89141-10  
 100 x 20 mm



	mmxmm
89142-01	30x 90
89142-02	50x100
89142-03	50x130
89142-04	50x175
89142-05	75x100
89142-06	75x130
89142-07	75x175



89147-21 - 89147-42

	l x b x h
89147-21	210x160x10 mm
89147-24	240x180x10 mm
89147-30	310x150x10 mm
89147-31	310x210x10 mm
89147-35	350x240x10 mm
89147-40	400x270x20 mm
89147-42	420x280x10 mm



89145-23 - 89145-40

	l x b x h
89145-23	230x155x30 mm
89145-30	300x175x30 mm
89145-31	300x175x40 mm
89145-35	350x240x36 mm

Wattedosen, Medizinlöffel, -becher  
 Cotton wool containers, Medicine Spoon and Cups  
 Distribuidores de algodón, Cuchara graduada, Vasos graduados  
 Vaso portacotone, Cucchiaino per medicinali, bicchieri per medicinali



mit Deckel  
 with Lid  
 Tapa  
 Coperchio



89146-20 20 cc  
 110 x 20 mm

	ø	h	l
89143-00	6 cm	6 cm	0,15 l
89143-01	8,5 cm	8,5 cm	0,4 l
89143-02	8,5 cm	12,5 cm	0,6 l
89143-03	8,5 cm	5 cm	0,25 l
89143-04	10 cm	10 cm	0,75 l
89143-05	10 cm	5 cm	0,35 l
89143-06	12 cm	12 cm	1,25 l
89143-07	15 cm	15 cm	2,5 l
89143-08	15 cm	10 cm	1,75 l
89143-09	20 cm	20 cm	6 l
89143-10	20 cm	10 cm	3 l



89147-10 100 cc  
 89147-25 250 cc



89148-25 25 cc  
 89148-50 50 cc

Stechbecken, Plazentabecken, Sputumbecher  
Bed Pan, Placenta Pan, Sputum Cup  
Silleta, Cubeta para placenta, Escupidera  
Padella, bacinella per placenta, Sputacchiera



89148-31  
ø 310 mm



89148-32



89148-35  
350 x 290 x 90 mm



89150-30  
90 x 80 mm



Verbandstofftrommel, Sterilisiersiebkorb  
 Sterilizing Drums, Sterilization Trays  
 Tambores p. esterilización, Cestas de esterilización  
 Tamburi p. sterilizzazione, Cestelli per erilizzazione



SCHIMMELBUSCH

Ø

mmxmm

89152-08	125x 80
89152-10	125x100
89152-12	125x125
89155-08	150x 80
89155-10	150x100
89155-13	150x130
89155-15	150x150
89155-19	150x190
89159-14	190x145
89159-16	190x165
89159-19	190x190
89159-24	190x240
89164-14	240x145
89164-16	240x165
89164-19	240x190
89164-24	240x240
89164-29	240x290
89164-34	240x340
89164-39	240x390
89169-14	290x145
89169-16	290x165
89169-19	290x190
89169-24	290x240
89169-29	290x290
89169-34	290x340
89169-39	290x390
89174-14	340x145
89174-16	340x165
89174-19	340x190
89174-24	340x240
89174-29	340x290
89174-34	340x340
89174-39	340x390
89179-14	390x145
89179-16	390x165
89179-19	390x190
89179-24	390x240
89179-29	390x290
89179-34	390x340
89179-39	390x390
89179-49	390x490
89179-59	390x590

18/10

Stainless Steel

Acero inoxidable

Acciajo inossidabile

Acciaio inossidabile

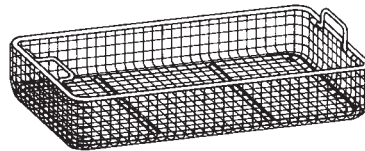

R390.03 255x245x 30 mm

R390.05 255x245x 50 mm

R390.07 255x245x 70 mm

R390.10 255x245x100 mm

R190.03 485x255x 30 mm

R190.05 485x255x 50 mm

R190.07 485x255x 70 mm

R190.10 485x255x100 mm

R191.03 540x255x 30 mm

R191.05 540x255x 50 mm

R191.07 540x255x 70 mm

R191.10 540x255x100 mm



Siebschalen, Endoskopiekorb  
 Trays  
 Bandejas  
 Cestelli

Aus perforiertem Blech  
 From Perforated Sheet Metal  
 De chapa de acero perforada  
 In acciaio perforato

18/10  
 Stainless Steel  
 Acero inoxidable  
 Acciajo inossidabile



	mm x mm x mm
89250-10	240 x 240 x 50
89250-20	240 x 240 x 80
89250-30	240 x 240 x 100
89250-40	480 x 260 x 50
89250-50	520 x 260 x 80
89250-60	520 x 260 x 100

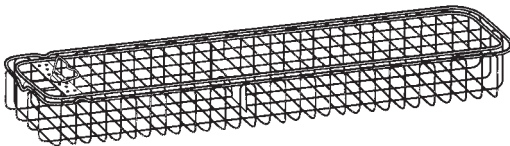

für 1 Endoskop, for 1 endoscope,  
 para 1 endoscopio, per 1 endoscopio

89256-29	290x80x52 mm
89256-46	460x80x52 mm
89256-67	670x80x52 mm

für 2 Endoskope, for 2 endoscopes,  
 para 2 endoscopios, per 2 endoscopi rigidi

89257-46	460x80x52 mm
----------	--------------

Schlauchklemmen, Messgerät, Sterilisierklammern  
 Tubing Clamp, Decimal spring caliper, Safety pins  
 Pinzas para tubos, calibrador decimal, Cadres de esterilizacion  
 Morsetti serratubi, compasso, pinze per sterilizzazione

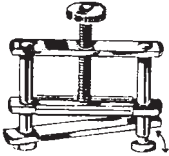

HOFFMANN  
 89260-13 13 mm  
 89260-17 17 mm  
 89260-20 20 mm  
 89260-25 25 mm  
 89260-30 30 mm  
 89260-40 40 mm

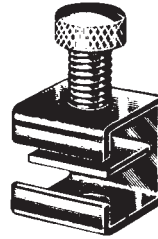

SIMPLEX  
 89265-12

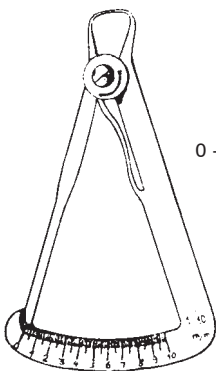

IWANSON  
 89270-15

0 - 10 mm



BUNT  
 29150-12  
 12 cm, 4 <sup>3</sup>/<sub>4</sub>"

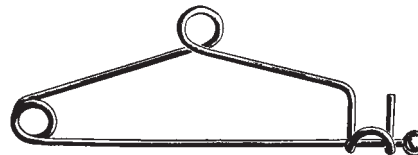

MAYO  
 29152-14  
 14 cm, 5 <sup>1</sup>/<sub>2</sub>"



Reinigungspistole  
Water Jet Pistol  
Pistola-lavatora  
Pistola lavatrice



89500-00  
komplett mit 9 Aufsätzen  
complete with 9 tips  
con 9 toberas  
completa con 9 raccordi



89500-01  
Reinigungsaufsatz für Flaschen  
Cleansing Tip for bottles  
Tobera para botellas  
Raccordo di lavaggio per bottiglie



89500-02  
Reinigungsaufsatz für Recordspritzen-Konen  
Cleansing Tip for Cones of Record Syringes  
Tobera para conos de jeringas Record  
Raccordo per coni di siringhe Record



89500-03  
Reinigungsaufsatz für Katheter  
Cleansing Tip for Catheters  
Tobera para catéteres  
Raccordo di lavaggio per cateteri



89500-04  
Reinigungsaufsatz für Drainageschläuche  
Cleansing Tip for Drainage Tubings  
Tobera para tubos de drenaje  
Raccordo di lavaggio per tubi di drenaggio



89500-05  
Reinigungsaufsatz für Hohlgefäße (Brause)  
Cleansing Tip for Receptacles (Shower)  
Tobera para recipientes (ducha)  
Raccordo di lavaggio per recipienti (doccia)

89500-12  
Pistole allein  
Pistol only  
Pistola sola  
Pistola sola



89500-06  
Reinigungsaufsatz für Kanülen mit Recordkonus  
Cleansing Tip for hypodermic needles with Record Cone  
Tobera para agujas de inyección con cono Record  
Raccordo di lavaggio per aghi ipodermici con cono Record



89500-07  
Reinigungsaufsatz für Kanülen mit Luerkonus  
Cleansing Tip for hypodermic needles with Luer Cone  
Tobera para agujas de inyección con cono Luer  
Raccordo di lavaggio per aghi ipodermici con cono Luer



89500-08  
Reinigungsaufsatz für Meß- und Vollpipetten  
Cleansing Tip for Meas. and Volumetric Pipettes  
Tobera para pipetas de medida y volumétricas  
Raccordo di lavaggio per pipette comuni e graduate

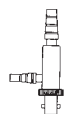

89500-09  
Reinigungsaufsatz für feine Pipetten  
Cleansing Tip for fine pipettes  
Tobera para pipetas finas  
Raccordo di lavaggio per pipette fine



89500-10  
Reinigungsaufsatz 31 cm (12 1/4") gerade  
Cleansing Tip 31 cm (12 1/4") straight  
Tobera 31 cm (12 1/4") recta  
Raccordo 31 cm (12 1/4") rette



89500-11  
Reinigungsaufsatz 30 cm (11 3/4") aufgebogen  
Cleansing Tip 30 cm (11 3/4") curved  
Tobera 30 cm (11 3/4") curva  
Raccordo di lavaggio 30 cm (11 3/4") curvo

89501-03  
Überwurfmutter zum Anschluß an Gewindehähne  
Couplings for connection to water tap  
Tuercas-hembras para conexión al grifo de agua  
Dadi premistoppa per connessione ai rubinetti filettati



Hochfrequenz-Chirurgie  
 High Frequency Surgery  
 Electrocirugía  
 Elettrochirurgia

Mindestbestellmenge 10  
 Minimum order quantity 10  
 Cantidad minima 10  
 Minimo di quantitativo 10



91010-01  
 Fig. 1

91010-02  
 Fig. 2 45°

91010-03  
 Fig. 3 120°

91010-11  
 Fig. 11  
 Ø 3 mm

91010-12  
 Fig. 12  
 Ø 5 mm

91010-13  
 Fig. 13  
 Ø 8 mm

91010-14  
 Fig. 14

91010-15  
 Fig. 15 45°  
 7,0x1,5 mm

91010-16  
 Fig. 16 45°  
 7 mm

91010-17  
 Fig. 17  
 6,0x1,3 mm

91010-18  
 Fig. 18 30°  
 7,0x1,7 mm

91010-21  
 Fig. 21  
 7,0x1,7 mm

91010-31  
 Fig. 31 45°  
 Ø 0,6 mm

91010-33  
 Fig. 33 45°  
 Ø 1,7 mm

91010-34  
 Fig. 34 45°  
 Ø 3,0 mm

91010-35  
 Fig. 35

91010-36  
 Fig. 36 90°

Schaft  
 shaft  
 vástago  
 asta  
 Ø 2,4 mm

Hochfrequenz-Chirurgie  
 High Frequency Surgery  
 Electrocirugía  
 Elettrochirurgia

Mindestbestellmenge 10  
 Minimum order quantity 10  
 Cantidad minima 10  
 Minimo di quantitativo 10



91011-51  
 Fig. 51 45°  
 Ø 3 mm



91011-52  
 Fig. 52 45°  
 7,0x1,7 mm



91011-53  
 Fig. 53 45°



91011-54  
 Fig. 54



91011-55  
 Fig. 55



91011-56  
 Fig. 56 45°  
 Ø 5 mm



91011-61  
 Fig. 61 45°



91011-62  
 Fig. 62 90°

Schaft  
 shaft  
 vástago  
 asta  
 Ø 2,4 mm

Serie STANDARD



91020-01



91020-02

Schaft  
 shaft  
 vástago  
 asta  
 Ø 4 mm



91020-03



91020-04



Ø mm  
 5 91022-05  
 10 91022-10  
 20 91022-20



Ø mm  
 10 91024-10  
 15 91024-15  
 20 91024-20



Ø mm  
 2 91030-02  
 4 91030-04  
 6 91030-06

Schaft  
 shaft  
 vástago  
 asta  
 Ø 4 mm

Bipolare Koagulation  
Bipolar Coagulation  
Coagulación bipolar  
Coagulazione bipolare



91102-11  
11 cm, 4  $\frac{3}{8}$ "

91104-11  
11 cm, 4  $\frac{3}{8}$ "



91109-11  
11 cm, 4  $\frac{3}{8}$ "  
45°  
0.5 mm

91113-11  
11 cm, 4  $\frac{3}{8}$ "  
45°  
0.5 mm



91115-11  
11 cm, 4  $\frac{3}{8}$ "  
45°  
0.5 mm



91122-16  
16,5 cm, 6  $\frac{1}{2}$ "  
0.5 mm

91123-16  
16,5 cm, 6  $\frac{1}{2}$ "  
0.5 mm



91124-16  
16,5 cm, 6  $\frac{1}{2}$ "  
1 mm

91125-16  
16,5 cm, 6  $\frac{1}{2}$ "  
0.5 mm



91127-16  
16,5 cm, 6  $\frac{1}{2}$ "  
1 mm



Bipolare Koagulation  
Bipolar Coagulation  
Coagulación bipolar  
Coagulazione bipolare



91142-16  
16,5 cm, 6 1/2"  
1 mm



91144-16  
16,5 cm, 6 1/2"  
0.5 mm



91146-16  
16,5 cm, 6 1/2"  
1 mm



91152-19  
19,5 cm, 7 3/4"  
0.3 mm



91154-19  
19,5 cm, 7 3/4"  
1 mm



91157-19  
19,5 cm, 7 3/4"  
1 mm



91159-19  
19,5 cm, 7 3/4"  
2 mm

Bipolare Koagulation  
 Bipolar Coagulation  
 Coagulación bipolar  
 Coagulazione bipolare



91162-19  
 19,5 cm, 7 3/4"  
 0,3 mm



91164-19  
 19,5 cm, 7 3/4"  
 1 mm



91166-19  
 19,5 cm, 7 3/4"  
 2 mm



91167-19  
 19,5 cm, 7 3/4"  
 1 mm



91169-19  
 19,5 cm, 7 3/4"  
 1 mm



91172-03 - 91172-12  
 22,5 cm, 8,9"



91172-03  
 0,3 mm



91172-07  
 0,7 mm



91172-12  
 1,2 mm

Verbindungskabel, bipolar  
 Connection Cords, bipolar  
 Cables de conexión, bipolar  
 Cavi da connessione, bipolare



ERBE  
 SELECT  
 STORZ  
 3 m 118"  
 5 m 197"



USA Mod.  
 91192-30  
 91192-50



MARTIN  
 BERCHTOLD  
 AESCULAP  
 91193-30  
 91193-50

für Elektro-Chirurgie-Einheiten  
 for Electrosurgery Equipment  
 para Electrobisturías  
 per Elettrobisturi

Monopolare Pinzetten  
 Monopolar Forceps  
 Pinzas monopolares  
 Pinze monopolare



91800-18 18 cm, 7"  
 91800-21 21 cm, 8 1/4"  
 91800-25 25 cm, 10"

ohne Buchse  
 without socket  
 sin casquillo  
 senza presa



91801-18 18 cm, 7"  
 91801-21 21 cm, 8 1/4"  
 91801-25 25 cm, 10"

mit Buchse  
 with socket  
 con casquillo  
 con presa

Instrumentenöl  
Instrument oil  
Oleo para instrumentos  
Olio per strumenti

INSTRU CARE ist ein Instrumentenpflegeöl auf der Basis von hochreinen medizinischen Weißölen zum Erhalt der Funktionsfähigkeit und Werterhaltung von chirurgischen Instrumenten. Die Anwendung erfolgt nach der Reinigung bzw. vor dem Sterilisationsvorgang.

INSTRU CARE is an instrument oil for care and protection of surgical instruments and guarantees the function and protects the value of instruments. It will be used after cleansing and before sterilization process.

INSTRU CARE olio para instrumentos

INSTRU CARE è un olio estremamente puro per la lubrificazione e la pulizia dello strumentario chirurgico. Privo di silicone, appropriato per la sterilizzazione a vapore e ad aria calda. Fisiologicamente inerte con utilizzo prima della sterilizzazione.



98000-01  
100ml

Kunststoff-Flasche  
plastic bottle  
bottiglia  
botella



98000-02  
400ml

Sprühdose  
aerosol  
spray  
spray

03112-00.....5	05151-02.....27	05311-01.....37	07402-08.....46	09121-20.....51
03112-01.....5	05160-02.....28	05311-02.....37	07402-09.....46	09124-14.....51
03112-02.....5	05160-03.....28	05311-03.....37	07402-10.....46	09125-14.....51
03113-00.....6	05160-04.....28	05311-04.....37	07403-01.....47	09128-14.....52
03113-01.....6	05170-24.....28	05320-01.....37	07403-02.....47	09130-14.....52
03113-02.....6	05190-17.....28	05320-02.....37	07410-05.....47	09131-14.....52
03114-00.....7	05190-20.....28	05320-03.....37	07412-05.....47	09140-14.....52
03114-01.....7	05190-25.....28	05320-04.....37	07420-08.....48	09141-14.....52
03114-02.....7	05203-00.....31	05321-01.....37	07421-09.....48	09150-14.....52
03120-00.....8	05204-00.....31	05321-02.....37	07422-19.....48	09151-14.....52
03122-00.....9	05210-00.....29	05321-03.....37	07423-16.....48	09160-14.....52/1
03126-00.....10	05210-01.....29	05321-04.....37	07423-20.....48	09160-17.....52/1
03132-00.....11	05210-02.....29	07103-00.....38	07423-24.....48	09160-19.....52/1
03132-01.....11	05210-03.....29	07103-01.....38	07424-11.....48	09160-23.....52/1
03132-02.....11	05210-04.....29	07103-02.....38	07424-14.....48	09160-28.....52/1
03133-00.....12	05211-00.....29	07104-00.....39	07424-17.....48	09161-14.....52/1
03133-01.....12	05211-01.....29	07104-02.....39	07425-11.....48	09161-17.....52/1
03133-02.....12	05211-02.....29	07105-02.....39	07490-00.....49	09161-19.....52/1
03161-00.....13	05211-03.....29	07106-01.....39/1	07490-01.....49	09161-23.....52/1
03161-01.....14	05211-04.....29	07106-02.....39/1	07490-02.....49	09161-28.....52/1
03161-02.....15	05220-00.....29	07107-00.....39/2	07495-31.....50	09164-14.....52/1
03161-03C.....16	05220-01.....29	07107-01.....39/2	07496-00.....49	09164-17.....52/1
03161-03T.....16	05220-02.....29	07107-03.....39/2	07496-31.....50	09164-23.....52/1
03167-03.....20	05220-03.....29	07107-04.....39/2	07498-00.....50	09165-14.....52/1
03171-00.....17	05220-04.....29	07108-00.....40	07499-00.....50	09165-17.....52/1
03171-01.....17	05221-00.....29	07109-03.....40	07499-01.....50	09165-23.....52/1
03171-02.....17	05221-01.....29	07109-10.....41	09102-11.....51	09170-15.....52/1
03180-90.....21	05221-02.....29	07109-13.....41	09102-13.....51	09170-17.....52/1
03180-92.....21	05221-03.....29	07109-15.....41	09102-14.....51	09170-21.....52/1
03180-93.....21	05221-04.....29	07110-00.....42	09102-15.....51	09171-15.....52/1
03195-00.....22	05223-00.....31	07111-00.....42	09102-16.....51	09171-17.....52/1
03195-01.....22	05224-00.....31	07112-00.....42	09102-18.....51	09171-21.....52/1
03195-04.....22	05230-00.....30	07113-00.....42	09102-20.....51	09174-15.....52/1
03195-06.....22	05230-01.....30	07115-00.....42	09103-11.....51	09174-17.....52/1
03195-07.....22	05230-02.....30	07116-00.....42	09103-13.....51	09174-21.....52/1
03195-08.....22	05230-03.....30	07118-00.....42	09103-14.....51	09175-15.....52/1
03195-09.....22	05230-04.....30	07119-00.....42	09103-15.....51	09175-17.....52/1
03195-10.....22	05233-18.....32	07120-00.....42	09103-16.....51	09175-21.....52/1
03246-00.....23	05234-28.....32	07121-00.....42	09103-18.....51	09180-17.....52/1
03246-01.....23	05234-37.....32	07122-00.....42	09103-20.....51	09181-17.....52/1
03246-02.....23	05238-01.....32	07123-00.....42	09104-14.....51	09190-16.....53
03248-00.....23	05238-02.....33	07124-00.....42	09105-14.....51	09191-16.....53
03260-15.....23	05238-03.....33	07125-00.....42	09110-11.....51	09194-16.....53
03262-18.....23	05239-01.....29/30	07130-00.....42	09110-13.....51	09195-16.....53
03288-17.....24	05239-02.....29/30	07161-00.....41	09110-14.....51	09202-10.....53
03288-20.....24	05239-03.....29	07162-00.....41	09110-15.....51	09203-10.....53
03292-22.....24	05240-30.....34	07165-00.....41	09110-16.....51	09204-22.....53
03294-24.....24	05241-11.....34	07167-00.....41	09110-18.....51	09206-10.....53
03304-20.....24	05241-22.....34	07200-17.....44	09110-20.....51	09207-10.....53
03306-17.....24	05300-01.....36	07200-20.....44	09111-11.....51	09280-12.....53/1
03308-18.....24	05300-02.....36	07201-13.....44	09111-13.....51	09280-15.....53/1
03310-01.....25	05300-03.....36	07201-16.....44	09111-14.....51	09280-18.....53/1
03310-02.....25	05300-04.....36	07201-19.....44	09111-15.....51	09280-20.....53/1
03312-01.....25	05300-05.....36	07201-22.....44	09111-16.....51	09280-23.....53/1
03314-01.....25	05300-06.....36	07202-12.....44	09111-18.....51	09280-25.....53/1
03320-19.....25	05301-01.....35	07203-16.....44	09111-20.....51	09280-28.....53/1
03340-10.....25	05301-02.....35	07203-19.....44	09114-14.....51	09280-30.....53/1
03340-15.....25	05301-03.....35	07203-22.....44	09115-14.....51	09281-12.....53/1
03340-20.....25	05301-04.....35	07204-11.....44	09120-11.....51	09281-15.....53/1
03340-30.....25	05301-05.....35	07205-09.....44	09120-13.....51	09281-18.....53/1
03340-50.....25	05301-06.....35	07290-09.....45	09120-14.....51	09281-20.....53/1
03350-15.....25	05301-07.....35	07291-11.....45	09120-15.....51	09281-23.....53/1
03360-21.....26	05302-01.....36	07294-13.....45	09120-16.....51	09281-25.....53/1
03361-10.....26	05302-02.....36	07296-00.....45/50	09120-18.....51	09281-28.....53/1
05130-05.....27	05302-03.....36	07402-01.....46	09120-20.....51	09281-30.....53/1
05130-10.....27	05303-01.....36	07402-02.....46	09121-11.....51	09282-15.....53/1
05140-05.....27	05304-01.....36	07402-03.....46	09121-13.....51	09282-18.....53/1
05140-08.....27	05310-01.....37	07402-04.....46	09121-14.....51	09282-20.....53/1
05150-21.....27	05310-02.....37	07402-05.....46	09121-15.....51	09282-23.....53/1
05150-27.....27	05310-03.....37	07402-06.....46	09121-16.....51	09282-25.....53/1
05151-01.....27	05310-04.....37	07402-07.....46	09121-18.....51	09282-28.....53/1

09283-15.....53/1	09348-05.....55	09505-23.....63	09829-12.....67	10013-19.....73
09283-18.....53/1	09348-06.....55	09505-26.....63	09831-12.....67	10014-19.....73
09283-20.....53/1	09349-09.....58	09505-30.....63	09835-12.....67	10015-19.....73
09283-23.....53/1	09349-12.....55	09507-23.....63	09850-10.....68	10016-17.....73
09283-25.....53/1	09350-09.....57	09507-26.....63	09851-10.....68	10017-17.....73
09283-28.....53/1	09350-10.....56	09507-30.....63	09854-11.....69	10018-20.....73
09284-12.....53/1	09351-09.....57	09510-20.....62	09859-16.....69	10019-20.....73
09284-15.....53/1	09352-09.....57	09510-23.....62	09860-16.....69	10020-17.....73
09284-18.....53/1	09353-09.....57	09511-20.....62	09861-16.....69	10021-17.....73
09284-20.....53/1	09354-10.....57	09511-23.....62	09898-20.....69/1	10022-20.....73
09284-23.....53/1	09355-10.....57	09512-20.....62	09901-09.....69/1	10023-20.....73
09284-25.....53/1	09356-10.....57	09512-23.....62	09901-11.....69/1	10024-17.....73
09284-28.....53/1	09357-10.....57	09513-20.....62	09901-14.....69/1	10025-17.....73
09284-30.....53/1	09358-11.....56	09513-23.....62	09901-18.....69/1	10026-20.....73
09285-12.....53/1	09360-11.....58	09514-20.....62	09901-20.....69/1	10027-20.....73
09285-15.....53/1	09361-11.....58	09514-23.....62	09905-14.....69/1	10028-14.....73
09285-18.....53/1	09362-11.....58	09515-20.....62	09905-18.....69/1	10029-14.....73
09285-20.....53/1	09363-11.....58	09515-23.....62	09906-18.....69/1	10030-18.....73
09285-23.....53/1	09370-11.....58	09516-23.....62	09906-20.....69/1	10031-18.....73
09285-25.....53/1	09371-11.....58	09517-23.....62	09911-23.....69/1	10032-23.....73
09285-28.....53/1	09374-11.....58	09523-24.....62	09913-20.....69/2	10033-23.....73
09285-30.....53/1	09375-11.....58	09525-22.....63	09913-22.....69/2	10034-14.....73
09286-15.....53/1	09381-11.....58	09530-17.....63	09915-23.....69/2	10035-14.....73
09286-18.....53/1	09401-18.....58	09531-17.....63	09921-16.....69/2	10036-18.....73
09286-20.....53/1	09403-15.....58	09536-27.....63	09921-19.....69/2	10037-18.....73
09286-23.....53/1	09405-16.....59	09537-27.....63	09930-14.....70	10038-23.....73
09286-25.....53/1	09406-16.....59	09540-16.....61	09931-14.....70	10039-23.....73
09286-28.....53/1	09425-17.....59	09541-16.....61	09933-23.....70	10040-18.....74
09287-15.....53/1	09427-17.....59	09542-16.....61	09935-23.....70	10041-18.....74
09287-18.....53/1	09435-18.....59	09543-16.....61	09937-23.....70	10042-18.....74
09287-20.....53/1	09437-19.....59	09548-18.....64	09939-23.....70	10044-14.....74
09287-23.....53/1	09439-17.....59	09550-10.....64	09941-20.....70	10045-14.....74
09287-25.....53/1	09468-15.....59	09551-16.....64	09950-15.....70	10046-14.....74
09287-28.....53/1	09470-11.....59	09553-16.....64	09950-18.....70	10047-14.....74
09289-28.....53/2	09473-21.....59	09560-14.....64	09960-14.....71	10048-14.....74
09290-25.....53/2	09475-00.....60	09560-22.....64	09961-14.....71	10049-14.....74
09291-18.....54	09475-25.....60	09580-11.....65	09962-14.....71	10102-11.....75
09291-20.....54	09475-45.....60	09581-11.....65	09962-17.....71	10104-11.....75
09291-23.....54	09475-60.....60	09582-15.....65	09962-23.....71	10110-12.....75
09295-18.....54	09475-90.....60	09583-15.....65	09963-14.....71	10111-12.....75
09295-20.....54	09476-00.....60	09601-22.....65	09963-17.....71	10113-11.....75
09295-23.....54	09476-25.....60	09610-18.....65	09963-23.....71	10115-11.....75
09296-15.....54	09476-45.....60	09611-18.....65	09964-15.....71	10117-11.....75
09296-18.....54	09476-60.....60	09613-20.....65/1	09964-17.....71	10119-10.....75
09296-23.....54	09476-90.....60	09614-19.....65/1	09965-15.....71	10120-16.....76
09302-14.....54/1	09477-01.....60	09617-13.....65/1	09965-17.....71	10120-18.....76
09303-14.....54/1	09478-25.....60	09619-17.....65/1	09966-11.....71	10120-22.....76
09304-14.....54/1	09478-45.....60	09641-30.....65/2	09967-11.....71	10121-16.....76
09305-14.....54/1	09478-60.....60	09643-19.....65/2	09970-14.....71	10121-18.....76
09310-12.....54/1	09479-25.....60	09643-25.....65/2	09970-18.....71	10121-22.....76
09310-15.....54/1	09479-45.....60	09651-24.....65/2	09970-20.....71	10122-16.....76
09312-12.....54/1	09479-60.....60	09661-23.....65/2	09970-23.....71	10122-18.....76
09314-12.....54/1	09480-25.....61	09770-18.....66	09971-14.....71	10122-22.....76
09320-15.....54/1	09480-40.....61	09772-21.....66	09971-18.....71	10123-16.....76
09321-15.....54/1	09480-60.....61	09774-21.....66	09971-20.....71	10123-18.....76
09321-18.....54/1	09481-25.....61	09775-13.....66	09971-23.....71	10123-22.....76
09325-15.....54/1	09481-40.....61	09777-13.....66	09980-11.....72	10124-16.....76
09340-09.....54/2	09481-60.....61	09802-09.....66	09981-11.....72	10124-18.....76
09340-10.....54/2	09490-16.....61	09802-11.....66	09982-12.....72	10124-22.....76
09340-11.....54/2	09490-23.....61	09803-09.....66	09983-12.....72	10125-16.....76
09341-09.....54/2	09490-28.....61	09803-13.....66	09984-11.....72	10125-18.....76
09341-10.....54/2	09491-16.....61	09804-14.....66	09985-11.....72	10125-22.....76
09341-11.....54/2	09491-23.....61	09809-15.....66	09986-11.....72	10126-00.....77
09344-11.....54/2	09491-28.....61	09820-13.....67	09990-14.....72	10126-25.....77
09345-11.....54/2	09492-16.....61	09821-13.....67	09990-18.....72	10126-45.....77
09346-11.....54/2	09492-23.....61	09823-12.....67	09993-15.....72	10126-60.....77
09347-09.....58	09492-28.....61	09824-12.....67	09993-18.....72	10126-90.....77
09348-01.....55	09496-15.....61	09825-12.....67	09995-12.....72	10127-00.....77
09348-02.....55	09497-15.....61	09826-12.....67	10010-19.....73	10127-25.....77
09348-03.....55	09501-22.....63	09827-12.....67	10011-19.....73	10127-45.....77
09348-04.....55	09501-23.....63	09828-12.....67	10012-19.....73	10127-60.....77

10127-90.....77	11120-25.....81/1	11232-15.....83	11404-04.....90	12340-16.....99
10128-09.....78	11120-30.....81/1	11233-20.....84	11405-05.....90	12340-20.....99
10128-15.....78	11122-12.....81/1	11234-20.....84	11407-07.....90	12340-24.....99
10129-15.....78	11122-13.....81/1	11235-20.....84	11802-09.....91	13001-08.....101
10130-15.....78	11122-14.....81/1	11236-15.....84	11802-10.....91	13001-10.....101
10131-14.....78	11122-15.....81/1	11236-20.....84	11802-11.....91	13001-12.....101
10131-18.....78	11122-18.....81/1	11237-20.....84	11810-07.....91	13002-08.....101
10132-18.....78	11122-21.....81/1	11240-14.....84	11810-09.....91	13002-10.....101
10133-10.....79	11122-25.....81/1	11242-14.....84	11810-11.....91	13002-12.....101
10135-10.....79	11124-15.....81/1	11246-18.....85	11812-10.....91	13005-10.....101
10137-01.....78	11126-18.....81	11248-18.....85	11813-10.....91	13005-14.....101
10137-02.....78	11126-21.....81	11250-14.....85	11815-12.....91	13005-20.....101
10140-08.....79	11126-25.....81	11252-20.....85	11816-10.....91	13006-10.....101
10141-08.....79	11130-11.....81/1	11256-15.....85	11817-10.....91	13006-14.....101
10142-08.....79	11130-13.....81/1	11256-20.....85	11821-11.....92	13006-20.....101
10143-08.....79	11130-14.....81/1	11256-25.....85	11822-13.....92	13010-30.....102
10151-11.....79	11130-16.....81/1	11257-15.....85	11823-13.....92	13010-35.....102
10153-11.....79	11130-18.....81/1	11258-15.....85	11824-14.....92	13010-40.....102
10155-11.....79	11130-20.....81/1	11259-15.....85	11825-14.....92	13010-50.....102
10202-18.....80	11132-16.....81/1	11260-12.....86	11828-15.....92	13011-30.....102
10203-18.....80	11132-18.....81/1	11260-15.....86	11900-01.....93	13011-35.....102
10313-14.....80	11132-20.....81/1	11261-15.....86	11901-05.....93	13011-40.....102
10313-16.....80	11132-25.....81/1	11270-12.....86	11910-01.....93	13011-50.....102
10320-09.....80	11132-30.....81/1	11270-15.....86	12102-12.....94	13012-30.....102
10330-19.....80	11140-11.....81/1	11271-15.....86	12103-12.....94	13012-35.....102
10331-19.....80	11140-13.....81/1	11271-18.....86	12104-15.....94	13012-40.....102
10333-19.....80	11140-14.....81/1	11272-15.....86	12105-15.....94	13012-50.....102
11102-10.....81	11140-16.....81/1	11273-15.....86	12108-18.....94	13013-30.....102
11102-11.....81	11140-18.....81/1	11274-06.....86	12109-18.....94	13013-35.....102
11102-13.....81	11140-20.....81/1	11274-08.....86	12110-15.....95	13013-40.....102
11102-14.....81	11140-25.....81/1	11274-10.....86	12110-20.....95	13013-50.....102
11102-16.....81	11150-13.....81/1	11302-17.....86	12110-24.....95	13014-30.....102
11102-18.....81	11150-14.....81/1	11302-23.....86	12110-30.....95	13014-35.....102
11102-20.....81	11150-16.....81/1	11303-17.....86	12200-16.....96	13014-40.....102
11102-25.....81	11150-13.....81/1	11304-17.....86	12201-16.....96	13014-50.....102
11102-30.....81	11160-14.....81/1	11305-17.....87	12291-22.....97	13015-30.....102
11103-14.....81	11160-16.....81/1	11310-17.....87	12293-22.....97	13015-35.....102
11104-12.....81	11170-12.....81/2	11311-17.....87	12295-22.....97	13015-40.....102
11104-13.....81	11170-15.....81/2	11312-17.....87	12297-22.....97	13015-50.....102
11104-14.....81	11174-12.....81/2	11312-18.....87	12302-16.....98	13090-40.....100
11104-15.....81	11174-15.....81/2	11313-17.....87	12302-20.....98	13090-45.....100
11104-18.....81	11176-12.....81/2	11314-01.....87	12302-24.....98	13090-50.....100
11104-21.....81	11176-15.....81/2	11314-02.....87	12304-16.....98	13091-40.....100
11104-25.....81	11177-12.....81/2	11315-01.....87	12304-20.....98	13091-45.....100
11106-13.....81	11178-12.....81/2	11315-02.....87	12304-24.....98	13091-50.....100
11106-15.....81	11179-12.....81/2	11316-14.....88	12304-30.....98	13092-07.....103
11110-11.....81	11180-12.....82	11316-16.....88	12306-16.....98	13092-08.....103
11110-13.....81	11180-15.....82	11316-20.....88	12306-20.....98	13092-10.....103
11110-14.....81	11181-12.....82	11317-00.....88	12306-24.....98	13092-12.....103
11110-16.....81	11181-15.....82	11317-12.....88	12306-30.....98	13093-07.....103
11110-18.....81	11186-12.....82	11317-23.....88	12308-16.....98	13093-08.....103
11110-20.....81	11186-15.....82	11318-18.....88	12308-20.....98	13093-10.....103
11110-25.....81	11187-12.....82	11318-20.....88	12308-24.....98	13093-12.....103
11110-30.....81	11187-18.....83	11318-25.....88	12308-30.....98	13096-06.....103
11112-18.....81	11187-20.....83	11319-12.....88	12309-16.....98	13096-07.....103
11112-21.....81	11187-25.....83	11319-14.....88	12309-20.....98	13096-09.....103
11112-25.....81	11187-30.....83	11320-18.....88	12309-24.....98	13096-11.....103
11114-14.....81	11188-12.....82	11320-23.....88	12309-30.....98	13097-06.....103
11114-16.....81	11188-15.....82	11322-15.....89	12310-16.....98	13097-07.....103
11114-20.....81	11189-12.....82	11322-18.....89	12310-20.....98	13097-09.....103
11114-25.....81	11189-15.....83	11322-23.....89	12310-24.....98	13097-11.....103
11116-18.....81	11189-20.....83	11324-23.....89	12310-30.....98	13098-06.....100
11116-21.....81	11189-25.....83	11325-15.....89	12320-15.....99	13099-07.....100
11116-25.....81	11190-10.....83	11325-23.....89	12320-20.....99	13102-04.....104
11120-10.....81/1	11220-17.....83	11325-25.....89	12320-24.....99	13102-05.....104
11120-11.....81/1	11221-17.....83	11326-23.....89	12325-16.....99	13103-04.....104
11120-13.....81/1	11222-17.....83	11328-15.....89	12325-20.....99	13103-05.....104
11120-14.....81/1	11223-17.....83	11328-20.....89	12325-24.....99	13110-50.....104
11120-16.....81/1	11224-17.....83	11401-01.....90	12330-16.....99	13110-55.....104
11120-18.....81/1	11225-17.....83	11403-03.....90	12330-20.....99	13110-65.....104
11120-20.....81/1	11231-20.....84	11403-04.....90	12330-24.....99	13110-70.....104



13110-75.....104	13310-24.....108	13381-15.....111	13447-20.....117	13580-80.....126
13110-90.....104	13310-26.....108	13382-15.....111	13448-22.....117	13591-20.....126
13111-50.....104	13310-30.....108	13383-15.....111	13449-22.....117	13591-23.....126
13111-55.....104	13311-13.....108	13384-20.....112	13450-24.....118	13593-20.....126
13111-65.....104	13311-14.....108	13384-26.....112	13451-24.....118	13593-23.....126
13111-70.....104	13311-16.....108	13385-20.....112	13453-18.....118	13595-10.....127
13111-75.....104	13311-18.....108	13385-26.....112	13453-24.....118	13595-20.....127
13111-90.....104	13311-20.....108	13386-20.....112	13455-01.....118	13595-30.....127
13115-00.....104	13311-22.....108	13386-26.....112	13455-02.....118	13595-40.....127
13210-10.....104	13311-24.....108	13387-20.....112	13456-01.....119	13597-10.....127
13211-10.....104	13311-26.....108	13387-26.....112	13456-02.....119	13597-20.....127
13212-10.....104	13311-30.....108	13390-20.....112	13456-03.....119	13597-30.....127
13213-10.....104	13312-14.....108	13391-20.....112	13457-28.....119	13597-40.....127
13214-10.....104	13312-16.....108	13391-23.....112	13459-18.....119	13598-24.....126
13215-10.....104	13313-14.....108	13393-20.....112	13459-28.....119	13599-24.....126
13220-12.....105	13313-16.....108	13394-20.....112	13471-14.....119/1	13600-20.....127
13220-14.....105	13320-13.....108	13395-20.....112	13471-16.....119/1	13601-20.....127
13220-18.....105	13320-14.....108	13410-18.....112	13471-18.....119/1	13605-26.....128
13220-21.....105	13320-16.....108	13411-18.....112	13471-23.....119/1	13610-21.....128/1
13221-12.....105	13320-18.....108	13412-18.....113	13473-22.....119/1	13611-21.....128/1
13221-14.....105	13320-20.....108	13413-18.....113	13474-19.....119/1	13612-21.....128/1
13221-18.....105	13320-22.....108	13414-20.....113	13474-24.....119/1	13613-21.....128/1
13221-21.....105	13320-24.....108	13415-14.....113	13474-26.....119/1	13620-24.....128/1
13222-12.....105	13320-26.....108	13415-18.....113	13475-14.....119/1	13620-26.....128/1
13223-12.....105	13320-30.....108	13416-18.....113	13475-18.....119/1	13620-30.....128/1
13224-12.....105	13321-13.....108	13420-14.....114	13477-15.....119/2	13621-24.....128/1
13225-12.....105	13321-14.....108	13421-01.....114	13477-19.....119/2	13621-26.....128/1
13226-12.....105	13321-16.....108	13421-02.....114	13479-22.....119/2	13621-30.....128/1
13227-12.....105	13321-18.....108	13421-03.....114	13479-25.....119/2	13622-24.....128/1
13230-12.....105	13321-20.....108	13421-04.....114	13479-28.....119/2	13622-26.....128/1
13230-14.....105	13321-22.....108	13421-05.....114	13480-15.....119/2	13622-30.....128/1
13230-18.....105	13321-24.....108	13421-06.....114	13480-18.....119/2	13623-24.....128/1
13230-21.....105	13321-26.....108	13421-07.....114	13481-15.....119/2	13623-26.....128/1
13231-12.....105	13321-30.....108	13422-00.....114	13481-18.....119/2	13623-30.....128/1
13231-14.....105	13322-14.....108	13422-01.....114	13491-19.....119/2	13702-14.....129
13231-18.....105	13322-16.....108	13422-02.....114	13493-23.....120	13704-16.....129
13231-21.....105	13323-14.....108	13422-03.....114	13495-18.....120	13704-18.....129
13232-12.....105	13323-16.....108	13422-06.....114	13497-20.....120	13710-15.....129
13233-12.....105	13330-13.....109	13425-02.....114	13499-16.....120	13710-18.....129
13240-14.....106	13330-15.....109	13425-03.....114	13501-23.....120	13710-20.....129
13240-18.....106	13330-18.....109	13425-04.....114	13503-21.....121	13712-15.....129
13241-14.....106	13330-20.....109	13425-05.....114	13505-21.....121	13712-18.....129
13241-18.....106	13331-13.....109	13425-06.....114	13507-22.....121	13712-20.....129
13242-16.....106	13331-15.....109	13428-21.....115	13507-23.....121	13720-18.....130
13243-16.....106	13331-18.....109	13431-13.....115	13513-23.....122	13730-16.....131
13244-14.....106	13331-20.....109	13431-16.....115	13515-23.....122	15101-09.....132
13245-14.....106	13340-16.....109	13431-18.....115	13517-23.....122	15103-07.....132
13250-14.....107	13340-20.....109	13431-20.....115	13519-20.....122	15103-09.....132
13250-18.....107	13341-16.....109	13431-23.....115	13519-22.....122	15105-09.....132
13251-14.....107	13341-20.....109	13431-25.....115	13519-24.....122	15107-10.....132
13251-18.....107	13345-12.....109	13431-28.....115	13520-23.....122	15107-13.....132
13254-14.....107	13345-14.....109	13432-19.....116	13520-24.....122	15108-14.....132
13255-14.....107	13350-16.....109	13433-19.....116	13523-23.....123	15111-09.....132
13256-14.....106	13350-20.....109	13434-28.....116	13551-14.....123	15111-11.....132
13257-14.....106	13351-16.....109	13435-28.....116	13551-18.....123	15111-13.....132
13258-16.....106	13351-20.....109	13438-01.....116	13551-20.....123	15111-15.....132
13259-16.....106	13356-15.....109	13438-02.....116	13554-21.....123	15115-11.....132
13260-14.....107	13358-15.....109	13438-03.....116	13555-21.....123	15117-13.....132
13261-14.....107	13358-20.....109	13438-04.....116	13556-24.....123	15121-11.....133
13262-16.....107	13360-15.....110	13441-01.....117	13561-20.....123	15121-13.....133
13263-16.....107	13364-14.....110	13441-02.....117	13563-20.....123	15123-11.....133
13264-16.....107	13366-19.....110	13441-03.....117	13564-20.....123/1	15123-13.....133
13265-16.....107	13368-14.....110	13441-04.....117	13565-20.....123/2	15125-14.....133
13270-14.....106	13368-16.....110	13442-21.....117	13565-25.....123/2	15140-16.....133
13271-14.....106	13370-13.....110	13442-26.....117	13570-23.....124	15150-19.....133
13310-13.....108	13372-13.....110	13443-21.....117	13571-25.....124	15161-18.....133
13310-14.....108	13374-14.....110	13443-26.....117	13573-22.....124	15164-15.....133
13310-16.....108	13376-16.....110	13444-21.....117	13574-24.....125	15164-20.....133
13310-18.....108	13377-25.....111	13444-26.....117	13575-24.....125	17110-20.....134
13310-20.....108	13377-26.....111	13445-21.....117	13579-21.....125	17110-25.....134
13310-22.....108	13380-15.....111	13445-26.....117	13580-60.....126	17111-20.....134

17111-25.....134	19152-64.....142	19196-04.....148/1	19250-24.....153	19314-20.....159
17112-20.....134	19158-51.....142	19196-05.....148/1	19270-02.....153	19315-06.....159
17112-25.....134	19158-64.....142	19196-06.....148/1	19270-03.....153	19315-21.....159
17113-20.....134	19158-76.....142	19210-12.....148/2	19270-04.....153	19317-21.....159
17113-25.....134	19158-82.....142	19211-12.....148/2	19270-06.....153	19318-40.....159
17120-28.....134	19159-50.....142	19212-01.....148/2	19271-02.....153	19318-57.....159
17121-28.....134	19159-64.....142	19212-02.....148/2	19271-03.....153	19318-78.....159
17131-21.....134	19159-70.....142	19214-13.....148/2	19271-04.....153	19330-40.....158
17133-17.....135	19159-90.....142	19214-18.....148/2	19271-06.....153	19330-55.....158
17160-22.....135	19160-17.....143	19215-01.....149	19280-01.....154	19332-19.....160
17160-25.....135	19161-17.....143	19215-02.....149	19280-02.....154	19332-21.....160
17161-22.....135	19162-10.....143	19215-03.....149	19280-03.....154	19340-10.....160
17161-25.....135	19162-13.....143	19215-13.....148/2	19280-04.....154	19340-15.....160
17170-18.....136	19168-06.....143/1	19215-18.....148/2	19280-06.....154	19340-20.....160
17170-20.....136	19168-08.....143/1	19216-01.....149	19281-01.....154	19344-14.....160
17170-25.....136	19168-10.....143/1	19216-02.....149	19281-02.....154	19344-20.....160
17170-30.....136	19168-12.....143/1	19216-05.....149	19281-03.....154	19344-26.....160
17171-18.....136	19168-17.....143/1	19216-07.....149	19281-04.....154	19345-01.....160
17171-20.....136	19168-20.....143/1	19216-10.....149	19281-06.....154	19345-02.....160
17171-25.....136	19168-25.....143/1	19217-03.....149	19282-02.....154	19345-03.....160
17172-18.....136	19169-25.....143/1	19217-05.....149	19282-03.....154	19348-22.....160
17172-25.....136	19170-20.....143/1	19217-07.....149	19282-04.....154	19350-35.....161
17173-18.....136	19170-25.....143/1	19220-01.....150	19282-06.....154	19350-60.....161
17173-25.....136	19170-32.....143/1	19220-02.....150	19296-01.....155	19350-70.....161
17174-25.....136	19170-40.....143/1	19220-03.....150	19296-02.....155	19360-04.....162
17175-25.....136	19170-45.....143/1	19220-04.....150	19296-03.....155	19364-40.....162
17180-18.....136	19170-50.....143/1	19221-01.....150	19296-04.....155	19364-50.....162
17180-25.....136	19170-65.....143/1	19221-02.....150	19296-06.....155	19364-60.....162
17207-13.....137	19170-76.....143/1	19221-03.....150	19296-08.....155	19364-70.....162
17210-13.....137	19171-30.....143/2	19221-04.....150	19297-01.....155	19366-08.....162
17210-16.....137	19171-40.....143/2	19222-02.....150	19297-02.....155	19367-08.....162
17210-18.....137	19171-50.....143/2	19222-03.....150	19297-03.....155	19370-40.....163
17220-25.....137	19171-60.....143/2	19222-04.....150	19297-04.....155	19370-50.....163
17226-25.....137	19171-70.....143/2	19227-02.....150	19297-06.....155	19370-60.....163
17227-25.....137	19172-30.....143/3	19227-03.....150	19297-08.....155	19370-75.....163
17229-25.....137	19173-20.....143/3	19227-04.....150	19298-01.....156	19370-85.....163
17230-26.....138	19173-30.....143/3	19229-02.....150	19299-01.....156	19372-22.....163
17231-26.....138	19173-40.....143/3	19229-03.....150	19300-02.....156	19374-45.....163
17233-26.....138	19174-17.....143/3	19230-10.....151	19300-03.....156	19374-55.....163
19102-12.....139	19174-25.....143/3	19230-12.....151	19300-04.....156	19374-65.....163
19102-15.....139	19174-37.....143/3	19230-14.....151	19300-06.....156	19378-25.....163
19104-15.....139	19174-40.....143/3	19230-16.....151	19301-02.....156	19380-35.....163
19110-13.....139	19175-28.....143/3	19230-18.....151	19301-03.....156	19380-50.....163
19110-18.....139	19176-25.....143/4	19231-11.....151	19301-04.....156	19381-50.....163
19120-00.....139	19177-27.....143/4	19231-13.....151	19301-06.....156	19382-50.....163
19120-14.....139	19178-28.....143/4	19231-15.....151	19302-01.....157	19385-38.....164
19120-15.....139	19179-28.....144	19232-08.....151	19302-02.....157	19385-57.....164
19120-17.....139	19180-19.....145	19232-10.....151	19302-03.....157	19388-40.....164
19122-13.....140	19181-22.....145	19232-12.....151	19302-04.....157	19388-50.....164
19123-11.....140	19181-25.....145	19232-14.....151	19302-05.....157	19388-65.....164
19124-15.....140	19183-25.....145	19232-16.....151	19302-06.....157	19400-01.....165
19125-14.....140	19185-25.....145	19232-18.....151	19304-19.....157	19400-02.....165
19126-13.....140	19187-25.....145	19233-08.....152	19306-20.....157	19400-03.....165
19127-11.....140	19187-38.....146	19233-11.....152	19307-01.....157	19480-22.....164
19131-21.....141	19187-50.....146	19233-15.....152	19307-02.....157	19480-27.....164
19132-15.....141	19187-75.....146	19233-17.....152	19310-01.....158	19482-45.....164
19134-20.....141	19189-25.....146	19233-20.....152	19310-02.....158	19482-73.....164
19135-19.....141	19189-38.....146	19233-23.....152	19310-03.....158	19482-82.....164
19136-20.....141	19189-50.....146	19234-20.....153	19310-04.....158	19484-01.....164
19137-16.....141	19189-75.....146	19235-21.....153	19310-05.....158	19484-02.....164
19140-00.....142	19190-64.....147	19236-01.....153	19312-01.....158	19490-22.....166
19140-01.....142	19191-25.....147	19236-02.....153	19312-02.....158	19490-43.....166
19140-02.....142	19191-40.....147	19236-08.....152	19312-03.....158	19490-65.....166
19150-01.....142	19191-62.....147	19236-10.....152	19312-04.....158	19492-25.....164
19150-02.....142	19192-23.....147	19236-12.....152	19312-05.....158	19493-80.....167
19150-03.....142	19195-01.....148	19236-14.....152	19314-07.....159	19494-00.....167
19150-04.....142	19195-02.....148	19236-16.....152	19314-10.....159	19494-12.....167
19152-25.....142	19195-03.....148	19236-18.....152	19314-12.....159	19494-13.....167
19152-31.....142	19196-01.....148/1	19240-10.....153	19314-14.....159	19494-14.....167
19152-38.....142	19196-02.....148/1	19240-20.....153	19314-15.....159	19494-16.....167
19152-51.....142	19196-03.....148/1	19250-16.....153	19314-16.....159	19494-18.....167

19494-45.....166	19688-01.....175	19771-01.....185	19825-06.....193/194	21115-10.....199
19494-60.....166	19688-02.....175	19771-02.....185	19826-06.....193/194	21120-16.....199
19494-75.....166	19689-01.....175/1	19771-03.....185	19831-25.....193/194	21121-14.....199
19495-60.....167	19689-02.....175/1	19772-00.....185	19833-33.....193/194	21121-18.....199
19495-80.....167	19690-31.....176	19772-03.....185	19834-01.....193/194	21122-13.....199
19496-00.....167	19692-32.....176	19780-01.....186	19902-10.....267	21122-18.....199
19496-12.....167	19694-01.....177	19781-55.....185/187	19903-00.....267	21125-01.....200
19496-14.....167	19694-02.....177	19781-65.....185/187	19910-00.....196	21125-02.....200
19496-50.....166	19694-03.....177	19782-00.....185	19911-00.....196	21125-03.....200
19496-90.....166	19696-18.....178	19783-00.....187	19912-50.....196	21125-04.....200
19497-14.....167	19698-18.....178	19783-01.....187	19912-70.....196	21150-00.....201
19498-01.....167	19710-00.....178/1	19783-24.....185	19913-50.....196	21150-02.....201
19498-02.....167	19710-01.....178/1, 178/2	19784-00.....187/1	19913-70.....196	21150-03.....201
19498-03.....167	19710-40.....178/1, 178/3	19784-30.....187/1	19914-41.....196	21150-06.....201
19610-07.....168	19710-45.....178/1, 178/3	19784-40.....187/1	19914-67.....196	21150-09.....201
19611-07.....168	19710-50.....178/1, 178/3	19784-50.....187/1	19915-48.....196	21150-12.....201
19620-07.....168	19710-55.....178/1, 178/3	19784-60.....187/1	19915-64.....196	21150-15.....201
19620-10.....168	19710-60.....178/1, 178/3	19784-78.....187/1	19916-64.....196	21150-80.....201
19621-07.....168	19711-00.....178/3	19784-80.....187/1	19916-80.....196	21150-90.....201
19621-10.....168	19711-01.....178/3, 178/4	19784-98.....187/1	19917-64.....196	21154-01.....202
19630-10.....168	19711-40.....178/2, 178/4	19784-99.....187/1	19918-64.....196	21154-02.....202
19631-10.....168	19711-45.....178/2, 178/4	19790-01.....186	19918-88.....196	21154-03.....202
19634-10.....168	19711-50.....178/2, 178/4	19790-02.....186	19960-01.....197	21154-04.....202
19635-10.....168	19711-55.....178/2, 178/4	19795-01.....188	19960-02.....197	21154-05.....202
19636-14.....168	19711-60.....178/2, 178/4	19795-02.....188	19960-03.....197	21154-06.....202
19637-14.....168	19712-00.....178/2	19798-01.....188	19960-04.....197	21160-04.....202
19640-14.....169	19713-00.....178/4	19798-02.....188	19960-05.....197	21160-06.....202
19641-14.....169	19721-00.....179	19798-03.....188	19960-06.....197	21160-07.....202
19650-10.....169	19721-15.....179	19798-04.....188	19970-01.....198	21160-08.....202
19651-10.....169	19726-01.....179	19799-03.....189	19980-01.....197	21160-10.....202
19654-13.....169	19738-45.....179	19799-04.....189	19980-02.....197	21160-12.....202
19655-13.....169	19738-50.....179	19799-05.....189	19980-03.....197	21160-14.....202
19670-14.....169	19738-55.....179	19799-06.....189	19980-04.....197	21162-12.....202
19670-16.....169	19738-60.....179	19800-01.....189/1	19980-05.....197	21190-14.....203
19670-20.....169	19738-65.....179	19800-02.....189/1	19980-06.....197	21270-12.....203
19670-24.....169	19744-00.....180	19800-03.....189/1	19980-18.....198	21270-14.....203
19671-14.....169	19744-17.....180	19800-04.....189/1	19990-18.....198	21270-16.....203
19671-16.....169	19745-40.....180	19802-09.....189/1	19995-22.....198	21270-18.....203
19671-20.....169	19745-45.....180	19802-11.....189/1	19995-38.....198	21270-23.....203
19671-24.....169	19745-50.....180	19802-14.....189/1	19998-03.....198	21272-12.....203
19672-11.....171	19745-55.....180	19802-16.....189/1	19998-05.....198	21272-14.....203
19673-11.....171	19745-60.....180	19802-18.....189/1	21102-11.....199	21272-16.....203
19674-15.....171	19745-65.....180	19803-14.....189/1	21102-13.....199	21272-18.....203
19675-00.....170	19745-70.....180	19804-18.....189/2	21102-14.....199	21272-23.....203
19675-13.....171	19748-01.....180	19805-18.....189/2	21102-16.....199	21290-12.....203
19676-00.....170	19748-02.....180	19806-18.....189/2	21102-18.....199	21290-14.....203
19677-13.....171	19748-03.....180	19810-22.....190	21102-20.....199	21290-16.....203
19677-19.....170	19748-04.....180	19812-60.....190	21102-25.....199	21290-18.....203
19677-25.....170	19754-00.....181	19813-00.....191	21104-11.....199	21292-12.....203
19677-32.....170	19758-85.....181	19816-00.....191	21104-13.....199	21292-14.....203
19678-05.....170	19759-00.....181	19820-02.....193/195	21104-14.....199	21292-16.....203
19678-06.....170	19760-14.....181	19820-03.....193/195	21104-16.....199	21292-18.....203
19678-16.....171	19762-16.....181	19820-10.....193/195	21104-18.....199	21310-15.....203
19679-20.....172	19764-18.....182	19820-20.....193/194	21104-20.....199	21320-12.....203
19679-22.....172	19764-20.....182	19820-90.....192/193	21104-25.....199	21320-18.....203
19680-19.....172	19764-25.....182	19820-91.....192/193	21106-11.....199	21331-25.....203
19681-19.....172	19765-01.....183	19820-99.....193	21106-13.....199	21340-45.....203
19681-21.....172	19765-02.....183	19821-01.....193/195	21106-14.....199	23104-00.....204
19682-26.....173	19765-03.....183	19821-02.....193/195	21106-16.....199	23110-30.....204
19683-26.....173	19765-04.....183	19821-03.....193/195	21106-18.....199	23110-35.....204
19684-14.....173	19766-90.....182	19821-04.....193/195	21106-20.....199	23110-40.....204
19684-16.....173	19767-01.....184	19822-01.....193	21106-25.....199	23110-45.....204
19684-20.....173	19767-02.....184	19822-02.....193	21108-14.....199	23110-50.....204
19684-26.....173	19767-18.....184	19822-21.....194	21109-18.....199	23110-55.....204
19685-14.....173	19767-25.....184	19822-22.....194	21110-13.....199	23110-60.....204
19685-16.....173	19770-01.....186	19822-22L.....194	21110-14.....199	23123-30.....204
19685-20.....173	19770-02.....186	19822-23.....193	21110-16.....199	23123-40.....204
19685-26.....173	19770-03.....186	19822-24.....193	21110-18.....199	23123-50.....204
19686-32.....174	19770-04.....186	19822-25.....193/194	21110-20.....199	23125-11.....204
19687-01.....175	19770-05.....186	19822-26.....193/194	21111-14.....199	23128-19.....204
19687-02.....175	19771-00.....185	19824-06.....193/194	21112-14.....199	23140-02.....204

23150-10.....205	25180-12.....209	25408-12.....212	25721-14.....217	27413-05.....222
23150-12.....205	25180-14.....209	25410-14.....212	25722-14.....217	27413-06.....222
23150-14.....205	25180-16.....209	25410-17.....212	25723-14.....217	27413-07.....222
23150-16.....205	25180-18.....209	25414-14.....212	25730-18.....217	27413-08.....222
23150-18.....205	25180-20.....209	25414-17.....212	25731-18.....217	27413-09.....222
23150-20.....205	25180-24.....209	25414-18.....212	27109-20.....218	27413-10.....222
23170-25.....205	25180-26.....209	25415-14.....212	27110-21.....218	27413-11.....222
23170-30.....205	25180-30.....209	25415-17.....212	27110-24.....218	27413-12.....222
23170-33.....205	25184-12.....209	25415-20.....212	27110-27.....218	27413-13.....222
23170-35.....205	25184-14.....209	25415-20.....212	27111-21.....218	27413-14.....222
23181-40.....205	25184-16.....209	25434-11.....212	27111-24.....218	27413-15.....222
23195-08.....207	25184-18.....209	25434-13.....212	27111-27.....218	27413-16.....222
23195-10.....207	25184-20.....209	25434-16.....212	27120-21.....218	27423-01.....222
23195-12.....207	25184-24.....209	25436-13.....212	27120-24.....218	27423-02.....222
23195-14.....207	25184-26.....209	25438-13.....212	27120-27.....218	27423-03.....222
23195-16.....207	25184-30.....209	25438-15.....213	27121-21.....218	27423-04.....222
23195-18.....207	25190-16.....209	25446-25.....213	27121-24.....218	27423-05.....222
23197-08.....207	25190-18.....209	25447-25.....213	27121-27.....218	27423-06.....222
23197-10.....207	25190-20.....209	25450-14.....213	27130-13.....219	27423-07.....222
23197-12.....207	25194-16.....209	25450-17.....213	27131-13.....219	27423-08.....222
23197-14.....207	25194-18.....209	25450-20.....213	27133-24.....219	27423-09.....222
23197-16.....207	25194-20.....209	25450-24.....213	27134-32.....219	27423-10.....222
23197-18.....207	25196-13.....209	25452-14.....213	27135-24.....219	27423-11.....222
23198-08.....207	25196-18.....209	25452-17.....213	27139-19.....219	27423-12.....222
23198-10.....207	25214-16.....210	25452-20.....213	27201-15.....220	27423-13.....222
23198-12.....207	25214-18.....210	25452-24.....213	27201-19.....220	27423-14.....222
23198-14.....207	25214-20.....210	25460-18.....213	27201-21.....220	27423-15.....222
23198-16.....207	25214-23.....210	25460-20.....213	27202-15.....220	27423-16.....222
23198-18.....207	25214-26.....210	25460-23.....213	27202-19.....220	27433-01.....222
23210-00.....206	25214-31.....210	25465-20.....213	27202-21.....220	27433-02.....222
23250-20.....206	25224-13.....210	25465-25.....213	27203-15.....220	27433-03.....222
23250-40.....206	25224-15.....210	25466-17.....213	27203-19.....220	27433-04.....222
23302-01.....206	25224-18.....210	25466-20.....213	27203-21.....220	27433-05.....222
23302-02.....206	25224-20.....210	25467-17.....213	27204-15.....220	27433-06.....222
23302-03.....206	25224-23.....210	25467-20.....213	27204-19.....220	27433-07.....222
23302-04.....206	25224-26.....210	25610-11.....214	27204-21.....220	27433-08.....222
23302-05.....206	25225-13.....210	25612-13.....214	27240-00.....220	27433-09.....222
23302-06.....206	25225-15.....210	25612-15.....214	27240-01.....220	27433-10.....222
23302-07.....206	25225-18.....210	25614-12.....214	27240-02.....220	27433-11.....222
23302-08.....206	25225-20.....210	25615-12.....214	27240-03.....220	27433-12.....222
23310-14.....206	25225-23.....210	25620-16.....214	27271-19.....221	27433-13.....222
23310-18.....206	25225-26.....210	25621-16.....214	27273-19.....221	27433-14.....222
25110-12.....208	25230-18.....210	25624-16.....214	27275-30.....221	27433-15.....222
25114-12.....208	25230-20.....210	25625-16.....214	27277-25.....221	27433-16.....222
25120-12.....208	25230-23.....210	25627-14.....214	27285-20.....221/1	27434-01.....222
25122-12.....208	25241-21.....210	25628-14.....214	27288-22.....221/1	27434-02.....222
25128-13.....208	25241-26.....210	25650-10.....216	27289-22.....221/1	27434-03.....222
25129-13.....208	25245-21.....210	25651-10.....216	27291-18.....221/1	27434-04.....222
25130-13.....208	25245-26.....210	25656-10.....216	27291-27.....221/1	27434-05.....222
25134-13.....208	25250-27.....210	25657-10.....216	27297-23.....221/1	27434-06.....222
25136-11.....208	25254-27.....210	25660-13.....217	27298-23.....221/1	27434-07.....222
25137-11.....208	25260-27.....210	25661-13.....217	27403-01.....222	27434-08.....222
25138-11.....208	25264-27.....210	25667-18.....215	27403-02.....222	27434-09.....222
25140-13.....208	25285-20.....211	25667-21.....215	27403-03.....222	27434-10.....222
25144-13.....208	25285-24.....211	25668-18.....215	27403-04.....222	27434-11.....222
25146-13.....208	25285-26.....211	25668-21.....215	27403-05.....222	27434-12.....222
25148-13.....208	25290-18.....211	25670-14.....215	27403-06.....222	27434-13.....222
25150-12.....208	25292-18.....211	25671-14.....215	27403-07.....222	27434-14.....222
25150-14.....208	25293-27.....211	25672-14.....215	27403-08.....222	27434-15.....222
25154-12.....208	25311-20.....211	25673-14.....215	27403-09.....222	27434-16.....222
25154-14.....208	25311-27.....211	25676-14.....215	27403-10.....222	27441-01.....223
25160-15.....209	25315-20.....211	25677-14.....215	27403-11.....222	27441-02.....223
25160-18.....209	25315-27.....211	25678-09.....215	27403-12.....222	27441-03.....223
25160-20.....209	25324-18.....211	25678-14.....216	27403-13.....222	27441-04.....223
25160-23.....209	25324-26.....211	25679-09.....215	27403-14.....222	27441-05.....223
25164-15.....209	25330-21.....212	25679-14.....216	27403-15.....222	27441-06.....223
25164-18.....209	25330-23.....212	25680-13.....215	27403-16.....222	27441-07.....223
25164-20.....209	25334-23.....212	25684-13.....215	27413-01.....222	27441-08.....223
25164-23.....209	25405-12.....212	25700-18.....217	27413-02.....222	27441-09.....223
25170-15.....209	25406-12.....212	25701-18.....217	27413-03.....222	27441-10.....223
25174-15.....209	25407-12.....212	25720-14.....217	27413-04.....222	27441-11.....223

27441-12.....223	29150-12.....227	31350-28.....232	33259-23.....240	33416-17.....248
27443-01.....223	29152-14.....227	31360-30.....232	33260-24.....240	33417-18.....248
27443-02.....223	31101-24.....229	31362-28.....232	33261-22.....240	33418-17.....248
27443-03.....223	31103-23.....229	31366-23.....232	33274-14.....241	33419-20.....248
27443-04.....223	31103-26.....229	31370-20.....233	33274-17.....241	33420-20.....249
27443-05.....223	31103-37.....229	31380-18.....233	33274-19.....241	33421-20.....249
27443-10.....223	31120-19.....229	31390-18.....233	33274-22.....241	33423-23.....249
27443-20.....223	31130-14.....229	31395-18.....233	33275-14.....241	33424-10.....249
27443-30.....223	31200-39.....230/4	31397-24.....233	33275-17.....241	33441-13.....249
27450-01.....223	31200-58.....230/4	33100-01.....234	33275-19.....241	33441-18.....249
27450-02.....223	31200-95.....230/18	33100-02.....234	33275-22.....241	33441-20.....249
27450-03.....223	31200-98.....230/4	33101-12.....234	33280-15.....241	33442-19.....249
27450-04.....223	31200-99.....230/4	33101-14.....234	33281-15.....241	33443-18.....249
27450-05.....223	31201-01.....230	33102-01.....234	33282-19.....241	33444-15.....250
27450-06.....223	31201-02.....230	33102-02.....234	33283-17.....241	33450-01.....250
27452-01.....223	31201-11.....230/2	33103-14.....235	33284-15.....241	33450-02.....250
27452-02.....223	31201-22.....230/2	33105-17.....235	33286-18.....241	33467-97.....251
27452-03.....223	31201-39.....230/4	33107-16.....235	33289-18.....241	33467-98.....251
27452-04.....223	31201-45.....230/7	33109-16.....235	33290-23.....242	33468-00.....251
27452-05.....223	31201-58.....230/4	33115-15.....236	33290-27.....242	33468-01.....251
27452-06.....223	31201-70.....230/7	33117-15.....236	33291-23.....242	33468-02.....251
27465-10.....223	31202-00.....230/7	33119-15.....236	33291-27.....242	33468-03.....251
27465-20.....223	31202-14.....230/18	33131-15.....236	33292-26.....242	33468-04.....251
27467-01.....223	31202-16.....230/18	33133-15.....236	33293-27.....242	33469-96.....251
27467-02.....223	31203-00.....230/5	33136-17.....236	33295-24.....242	33469-97.....251
27467-03.....223	31203-10.....230/5	33137-17.....236	33300-21.....243	33469-98.....251
27467-04.....223	31203-20.....230/5	33142-20.....236	33362-21.....243	33470-00.....251
27467-05.....223	31203-30.....230/5	33143-20.....236	33365-19.....243	33470-01.....251
27475-10.....223	31203-50.....230/17	33147-20.....237	33366-19.....243	33470-02.....251
27475-20.....223	31204-00.....230/5	33148-18.....237	33366-23.....243	33470-03.....251
27477-01.....223	31204-01.....230/15	33150-16.....237	33366-26.....243	33470-04.....251
27477-02.....223	31204-02.....230/15	33151-16.....237	33368-26.....243	33470-05.....251
27477-03.....223	31204-03.....230/15	33152-17.....237	33370-22.....244	33470-06.....251
27477-04.....223	31204-04.....230/15	33153-17.....237	33370-27.....244	33471-96.....251
27477-05.....223	31204-10.....230/5	33154-18.....237	33370-30.....244	33471-97.....251
27485-10.....223	31204-20.....230/5	33155-18.....237	33372-22.....244	33471-98.....251
27485-20.....223	31204-30.....230/5	33156-18.....237	33372-26.....244	33472-00.....251
27487-01.....223	31205-00.....230/6	33157-02.....237	33372-33.....244	33472-01.....251
27487-02.....223	31205-08.....230/16	33157-03.....237	33378-15.....244	33472-02.....251
27487-03.....223	31205-09.....230/16	33157-04.....238	33378-17.....244	33472-03.....251
27487-04.....223	31205-20.....230/16	33157-05.....238	33378-21.....244	33472-04.....251
27487-05.....223	31205-21.....230/16	33157-06.....238	33380-15.....244	33472-05.....251
27610-12.....224	31210-10.....230/6	33158-03.....238	33380-17.....244	33472-06.....251
27612-12.....224	31210-21.....230/10	33158-04.....238	33380-21.....244	33473-01.....252
27614-12.....224	31210-22.....230/10	33158-05.....238	33382-33.....244	33473-02.....252
27616-12.....224	31210-30.....230/18	33159-03.....238	33382-45.....244	33473-03.....252
27620-18.....224	31210-45.....230/14	33159-04.....238	33384-33.....244	33473-04.....252
27630-12.....224	31210-50.....230/14	33159-05.....238	33384-45.....244	33473-05.....252
27640-13.....224	31210-65.....230/14	33201-18.....238	33391-15.....245	33473-06.....252
27642-14.....224	31211-45.....230/14	33202-18.....238	33391-19.....245	33474-96.....251
27660-07.....224	31211-50.....230/14	33205-18.....238	33391-24.....245	33474-97.....251
27660-11.....224	31211-65.....230/14	33211-15.....238	33391-26.....245	33474-98.....251
27660-12.....224	31212-02.....230/18	33213-15.....238	33391-28.....245	33475-00.....251
27660-14.....224	31212-50.....230/14	33216-18.....239	33395-17.....245	33475-01.....251
27660-16.....224	31212-65.....230/14	33217-18.....239	33395-25.....245	33475-02.....251
27660-18.....224	31220-21.....230/12	33219-23.....239	33395-26.....245	33475-03.....251
27660-20.....224	31220-22.....230/12	33220-20.....239	33395-27.....245	33475-04.....251
27660-22.....224	31220-99.....230/18	33230-22.....239	33402-17.....246	33475-05.....251
27680-00.....226	31250-00.....231	33230-26.....239	33404-20.....246	33475-06.....251
29102-16.....227	31250-10.....231/1	33231-22.....239	33405-20.....246	33476-01.....253
29102-20.....227	31250-12.....231/1	33231-26.....239	33406-20.....246	33476-02.....253
29102-24.....227	31250-13.....231/1	33235-23.....239	33407-19.....246	33476-03.....253
29110-27.....227	31250-14.....231/1	33237-23.....239	33409-13.....246	33476-98.....253
29120-20.....227	31250-15.....231/1	33241-30.....240	33410-19.....246	33476-99.....253
29120-28.....227	31252-11.....231	33243-30.....240	33412-16.....247	33477-00.....253
29121-20.....227	31252-22.....231	33245-23.....240	33412-24.....247	33477-01.....253
29121-28.....227	31253-00.....231	33247-23.....240	33413-14.....247	33477-02.....253
29130-23.....227	31253-11.....231	33251-26.....240	33414-21.....247	33477-03.....253
29140-20.....227	31254-10.....231	33253-26.....240	33415-23.....248	33477-04.....253
29140-30.....227	31254-11.....231	33257-23.....240	33415-25.....248	33477-05.....253
29145-55.....227	31254-12.....231	33258-23.....240	33415-28.....248	33477-06.....253

33478-98.....253	33492-20.....257	33622-04.....259	33645-09.....261	33661-07.....263
33478-99.....253	33494-13.....257	33622-05.....259	33645-13.....261	33661-10.....263
33479-00.....253	33494-14.....257	33622-06.....259	33645-16.....261	33661-15.....263
33479-01.....253	33494-17.....257	33622-07.....259	33645-19.....261	33661-20.....263
33479-02.....253	33495-16.....257	33622-08.....259	33645-25.....261	33661-25.....263
33479-03.....253	33496-00.....257	33623-02.....259	33645-32.....261	33661-30.....263
33479-04.....253	33496-01.....257	33623-03.....259	33647-06.....261	33664-04.....263
33479-05.....253	33496-12.....257	33623-04.....259	33647-09.....261	33664-06.....263
33479-06.....253	33497-00.....257	33623-05.....259	33647-14.....261	33664-08.....263
33480-97.....254	33498-00.....257	33623-06.....259	33647-16.....261	33664-10.....263
33480-98.....254	33498-01.....257	33623-07.....259	33647-19.....261	33664-12.....263
33481-00.....254	33498-12.....257	33623-08.....259	33647-25.....261	33665-04.....263
33481-01.....254	33500-01.....256	33625-02.....259	33647-32.....261	33665-06.....263
33481-02.....254	33500-02.....256	33625-03.....259	33649-09.....261	33665-08.....263
33481-03.....254	33500-03.....256	33625-04.....259	33649-14.....261	33665-10.....263
33481-04.....254	33509-03.....258	33625-05.....259	33649-16.....261	33665-12.....263
33481-05.....254	33509-05.....258	33625-06.....259	33649-19.....261	33665-24.....264
33481-06.....254	33509-08.....258	33625-07.....259	33649-25.....261	33665-26.....264
33482-01.....253	33510-12.....258	33625-08.....259	33649-32.....261	33665-55.....264
33482-02.....253	33510-14.....258	33626-25.....260	33650-04.....261	33665-90.....264
33482-03.....253	33510-16.....258	33626-35.....260	33650-06.....261	33666-22.....264
33482-97.....254	33600-02.....259	33627-04.....260	33650-08.....261	33668-03.....265
33482-98.....254	33600-03.....259	33627-06.....260	33650-10.....261	33668-05.....265
33483-00.....254	33600-04.....259	33628-03.....260	33650-13.....261	33668-06.....265
33483-01.....254	33600-05.....259	33628-05.....260	33650-16.....261	33668-08.....265
33483-02.....254	33600-06.....259	33630-06.....260	33650-18.....261	33668-09.....265
33483-03.....254	33600-08.....259	33630-08.....260	33650-20.....261	33668-13.....265
33483-04.....254	33600-09.....259	33630-10.....260	33650-25.....261	33668-16.....265
33483-05.....254	33600-10.....259	33630-12.....260	33650-30.....261	33668-19.....265
33483-06.....254	33602-04.....259	33630-15.....260	33650-38.....261	33669-05.....264
33484-97.....254	33602-06.....259	33630-20.....260	33650-44.....261	33669-10.....264
33484-98.....254	33602-08.....259	33630-25.....260	33650-50.....261	33669-15.....264
33485-00.....254	33602-10.....259	33630-30.....260	33651-04.....261	33670-05.....264
33485-01.....254	33602-12.....259	33631-10.....260	33651-06.....261	33670-06.....265
33485-02.....254	33602-14.....259	33631-12.....260	33651-08.....261	33670-09.....265
33485-03.....254	33602-16.....259	33631-15.....260	33651-10.....261	33670-10.....264
33485-04.....254	33604-04.....259	33631-20.....260	33651-13.....261	33670-13.....265
33485-05.....254	33604-06.....259	33631-25.....260	33651-16.....261	33670-15.....264
33485-06.....254	33604-08.....259	33631-30.....260	33651-18.....261	33670-16.....265
33485-21.....255	33604-10.....259	33632-06.....260	33651-20.....261	33670-19.....265
33485-99.....255	33604-12.....259	33632-08.....260	33651-25.....261	33670-25.....265
33486-00.....255	33604-14.....259	33632-10.....260	33651-30.....261	33670-32.....265
33486-01.....255	33604-16.....259	33632-12.....260	33651-38.....261	33671-06.....265
33486-02.....255	33605-04.....259	33632-15.....260	33651-44.....261	33671-09.....265
33486-99.....255	33605-06.....259	33632-20.....260	33651-50.....261	33671-13.....265
33487-00.....255	33605-08.....259	33632-25.....260	33652-02.....262	33671-16.....265
33487-01.....255	33605-10.....259	33632-30.....260	33652-03.....262	33671-19.....265
33487-02.....255	33605-12.....259	33633-06.....260	33652-04.....262	33671-25.....265
33487-99.....255	33605-14.....259	33633-08.....260	33652-06.....262	33671-32.....265
33488-00.....255	33605-16.....259	33633-10.....260	33652-08.....262	33672-06.....265
33488-01.....255	33610-04.....259	33633-12.....260	33652-10.....262	33672-09.....265
33488-02.....255	33610-06.....259	33633-15.....260	33652-12.....262	33672-13.....265
33489-00.....255	33610-08.....259	33633-20.....260	33652-15.....262	33672-16.....265
33489-01.....255	33610-10.....259	33633-25.....260	33654-02.....262	33672-19.....265
33489-02.....255	33610-12.....259	33633-30.....260	33654-03.....262	33672-25.....265
33489-03.....255	33610-14.....259	33634-06.....260	33654-04.....262	33672-32.....265
33490-10.....256	33611-04.....259	33634-08.....260	33654-06.....262	33673-06.....265
33490-20.....256	33611-06.....259	33634-10.....260	33654-08.....262	33673-09.....265
33490-30.....256	33611-08.....259	33634-12.....260	33654-10.....262	33673-13.....265
33490-40.....256	33611-10.....259	33634-15.....260	33654-12.....262	33673-16.....265
33490-50.....256	33611-12.....259	33634-20.....260	33654-15.....262	33673-19.....265
33491-01.....256	33611-14.....259	33634-25.....260	33656-28.....262	33673-25.....265
33491-02.....256	33620-02.....259	33634-30.....260	33657-28.....262	33673-32.....265
33491-03.....256	33620-03.....259	33644-06.....261	33658-28.....262	33675-06.....265
33491-04.....256	33620-04.....259	33644-09.....261	33659-28.....262	33675-09.....265
33491-05.....256	33620-05.....259	33644-13.....261	33660-07.....263	33675-13.....265
33491-06.....256	33620-06.....259	33644-16.....261	33660-10.....263	33675-16.....265
33491-07.....256	33620-07.....259	33644-19.....261	33660-15.....263	33675-19.....265
33491-08.....256	33620-08.....259	33644-25.....261	33660-20.....263	33675-25.....265
33492-13.....257	33622-02.....259	33644-32.....261	33660-25.....263	33675-32.....265
33492-16.....257	33622-03.....259	33645-06.....261	33660-30.....263	33676-01.....266



33676-02.....266	33716-18.....276	33804-15.....285	34101-04.....295	34320-25.....302
33676-05.....266	33717-19-01.....277	33805-22.....285	34101-05.....295	34320-27.....302
33676-10.....266	33717-19-02.....277	33805-33.....285	34101-06.....295	34320-30.....302
33676-16.....266	33718-16.....277	33807-24.....285	34101-07.....295	34320-32.....302
33676-25.....266	33719-17.....277	33809-22.....285	34105-01.....296	34320-35.....302
33677-05.....266	33720-19.....277	33810-24.....286	34110-00.....296	34320-40.....302
33677-10.....266	33720-21.....277	33811-06.....286	34112-00.....296	34320-45.....302
33677-16.....266	33721-17.....278	33811-08.....286	34112-01.....296	34320-50.....302
33677-25.....266	33723-17.....278	33812-16.....286/1	34112-02.....296	34320-60.....302
33678-24.....267	33725-17.....278	33813-12.....286/1	34114-39.....296	34320-70.....302
33679-13.....267	33727-17.....278	33814-44.....286/2	34116-30.....296	34321-10.....302
33680-22.....267	33728-24.....278	33814-65.....286/2	34118-31.....296	34321-15.....302
33682-01.....268	33729-01.....278	33823-26.....288	34120-23.....296	34321-20.....302
33682-02.....268	33729-02.....278	33825-26.....288	34161-13.....297	34321-25.....302
33682-22.....267	33729-03.....278	33826-00.....289	34162-13.....297	34321-27.....302
33683-01.....268	33729-04.....278	33826-01.....289	34172-00.....297	34321-30.....302
33683-02.....268	33729-05.....278	33826-02.....289	34172-01.....297	34321-32.....302
33683-03.....268	33729-06.....278	33826-03.....289	34175-00.....297	34321-35.....302
33683-04.....268	33729-07.....278	33827-17.....289	34175-01.....297	34321-40.....302
33683-05.....268	33729-24.....278	33828-21.....290	34210-20.....298	34321-45.....302
33683-06.....268	33731-22.....279	33829-25.....290	34212-25.....298	34321-50.....302
33684-00.....269	33733-22.....279	33830-23.....290	34212-30.....298	34321-60.....302
33686-25.....270	33740-19.....279	33831-16.....291	34212-35.....298	34321-65.....302
33687-75.....270	33741-18.....279	33832-01.....291	34212-40.....298	34321-70.....302
33688-45.....270	33742-18.....279	33832-02.....291	34214-05.....298	34321-80.....302
33689-90.....270	33743-18.....279	33832-03.....291	34214-08.....298	34321-90.....302
33690-22.....270	33745-19.....280	33832-04.....291	34214-10.....298	34322-00.....302
33691-34.....271	33746-19.....280	33832-05.....291	34214-12.....298	34322-11.....302
33692-26.....271	33747-18.....280	33833-16.....291	34214-16.....298	34322-15.....302
33693-32.....271	33748-20.....280	33910-17.....292	34216-10.....298	34322-20.....302
33693-33.....271	33749-10.....280	33911-17.....292	34216-15.....298	34322-25.....302
33693-34.....271	33749-13.....280	33913-17.....292	34216-20.....298	34322-27.....302
33694-01.....270	33749-19.....280	33921-22.....292	34220-24.....298	34322-32.....302
33694-03.....270	33749-25.....280	33923-22.....292	34222-25.....298	34322-35.....302
33695-40.....271	33754-17.....282	34222-01.....292	34222-30.....298	34322-45.....302
33696-75.....271	33755-17.....282	33950-02.....292	34222-35.....298	34392-14.....304
33698-98.....271	33756-17.....282	33950-03.....292	34230-28.....298	34393-18.....304
33699-00.....270	33757-17.....282	33950-04.....292	34231-15.....298	34393-21.....304
33699-17.....271	33758-01.....281	33950-05.....292	34232-00.....298	34394-14.....304
33700-01.....272	33758-02.....281	33960-15.....292	34240-27.....299	34401-08.....306
33700-01-01.....272	33758-04.....280	33960-25.....292	34241-00.....299	34401-10.....306
33700-02.....272	33758-06.....280	33960-45.....292	34242-09.....299	34401-11.....306
33700-03.....272	33758-08.....280	33960-55.....292	34242-14.....299	34401-12.....306
33700-04.....272	33759-06.....282	33961-15.....292	34242-16.....299	34401-13.....306
33700-05.....273	33759-12.....282	33962-16.....292	34242-22.....299	34401-14.....306
33700-06.....273	33759-19.....282	33963-12.....293	34243-02.....299	34401-15.....306
33700-07.....273	33759-25.....282	33964-15.....293	34244-10.....299	34401-16.....306
33700-08.....273	33760-01.....282	33964-19.....293	34244-14.....299	34401-17.....306
33702-15.....274	33760-02.....282	33964-24.....293	34244-16.....299	34401-18.....306
33703-15.....274	33760-03.....282	33965-15.....293	34244-17.....299	34401-20.....306
33704-01.....274	33761-21.....282	33965-19.....293	34246-00.....299	34401-22.....306
33704-02.....274	33763-01.....282	33965-24.....293	34248-00.....299	34401-23.....306
33705-05.....274	33763-02.....282	33966-11.....293	34250-00.....299	34401-24.....306
33705-10.....274	33763-03.....282	33966-15.....293	34252-00.....299	34401-25.....306
33705-15.....274	33763-04.....282	33967-15.....293	34270-00.....299	34401-28.....306
33705-20.....274	33765-17.....283	33967-20.....294	34270-01.....299	34401-30.....306
33705-25.....274	33767-19.....283	33968-30.....294	34280-00.....300	34402-08.....306
33706-18.....274	33769-30.....283	33968-60.....294	34290-00.....300	34402-10.....306
33707-17.....275	33771-71.....283	33969-18.....294	34295-00.....300	34402-11.....306
33708-19.....275	33771-73.....283	33969-23.....294	34296-00.....300	34402-12.....306
33709-21.....275	33801-08.....284	33970-01.....294	34296-05.....300	34402-13.....306
33710-19.....275	33801-12.....284	33970-02.....294	34296-10.....300	34402-14.....306
33711-16.....276	33801-18.....284	33970-03.....294	34296-15.....300	34402-15.....306
33711-18.....275	33801-43.....284	33971-24.....294	34296-20.....300	34402-16.....306
33711-20.....275	33801-70.....284	33972-22.....294	34296-25.....301	34402-17.....306
33711-21.....275	33802-01.....284	33973-27.....294	34296-30.....301	34402-18.....306
33712-16.....276	33802-02.....284	33975-30.....294	34296-35.....301	34402-19.....306
33713-16.....276	33802-14.....284	33977-28.....294	34296-40.....301	34402-20.....306
33713-17.....276	33803-05.....284	34101-01.....295	34320-10.....302	34402-22.....306
33714-15.....276	33803-07.....284	34101-02.....295	34320-15.....302	34402-23.....306
33715-20.....276	33803-43.....285	34101-03.....295	34320-20.....302	34402-24.....306





34435-10.....308	34445-18.....309	34519-02.....313	34570-02.....321	41056-28.....328
34435-12.....308	34445-20.....309	34520-02.....314	34573-35.....321	41058-18.....328
34435-14.....308	34445-25.....309	34520-03.....314	34583-60.....321	41058-28.....328
34435-16.....308	34445-28.....309	34520-04.....314	34584-60.....321	41061-16.....329
34435-18.....308	34445-30.....309	34520-05.....314	34585-60.....321	41064-16.....329
34435-20.....308	34446-16.....309	34520-06.....314	34588-01.....321	41068-20.....329
34435-22.....308	34446-18.....309	34520-07.....314	34588-02.....321	41069-20.....329
34435-23.....308	34446-20.....309	34520-08.....314	34588-03.....321	41070-29.....329
34435-24.....308	34446-25.....309	34520-09.....314	34590-00.....322	41074-23.....329/1
34435-26.....308	34446-28.....309	34520-10.....314	34590-01.....322	41075-24.....329/1
34435-28.....308	34446-30.....309	34520-12.....314	34590-02.....322	41076-03.....329/1
34435-30.....308	34447-16.....309	34520-15.....314	34596-29.....322	41076-04.....329/1
34436-16.....308	34447-18.....309	34528-01.....315	34596-37.....322	41076-05.....329/1
34436-18.....308	34447-20.....309	34528-02.....315	34596-42.....322	41076-07.....329/1
34436-20.....308	34447-25.....309	34528-03.....315	34596-49.....322	41078-23.....329/2
34436-25.....308	34447-28.....309	34530-28.....315	34597-06.....322	41079-21.....329/2
34436-28.....308	34447-30.....309	34531-21.....315	34597-07.....322	41080-19.....330
34436-30.....308	34450-08.....310	34533-17.....316	34597-08.....322	41081-19.....330
34437-16.....308	34450-10.....310	34534-15.....316	34597-09.....322	41083-19.....330
34437-18.....308	34450-12.....310	34534-18.....316	34597-10.....322	41085-20.....330
34437-20.....308	34450-14.....310	34535-16.....316	34597-11.....322	41090-33.....330
34437-25.....308	34450-15.....310	34536-14.....316	34597-12.....322	41091-31.....330
34437-28.....308	34450-16.....310	34537-19.....316	34597-13.....322	41091-41.....330
34437-30.....308	34450-18.....310	34538-01.....316	34597-14.....322	41092-30.....332
34438-16.....308	34450-20.....310	34538-02.....316	34597-15.....322	41092-40.....332
34438-18.....308	34450-22.....310	34538-03.....316	34597-16.....322	41092-50.....332
34438-20.....308	34450-25.....310	34539-01.....316	34597-17.....322	41092-60.....332
34438-25.....308	34450-30.....310	34539-02.....316	34597-18.....322	41092-70.....332
34438-28.....308	34460-08.....310	34539-03.....316	34597-19.....322	41094-00.....332
34438-30.....308	34460-10.....310	34540-01.....317	34597-20.....322	41096-21.....332
34439-00.....305	34460-12.....310	34540-02.....317	34612-00.....322/1	41097-22.....331
34439-16.....308	34460-14.....310	34540-16.....317	34613-00.....322/1	41141-25.....332
34439-18.....308	34460-15.....310	34540-18.....317	34615-00.....322/1	41143-21.....332
34439-20.....308	34460-16.....310	34540-19.....317	34617-00.....322/1	41145-21.....332
34439-25.....308	34460-20.....310	34540-20.....317	34620-25.....323	41146-18.....332
34439-28.....308	34460-22.....310	34541-23.....317/1	34624-01.....323	41146-24.....332
34439-30.....308	34460-25.....310	34542-15.....317/1	34624-02.....323	41147-21.....332
34440-01.....305	34460-30.....310	34543-23.....317/1	34624-03.....323	41149-22.....332
34440-02.....305	34470-08.....310	34544-18.....317/1	34624-04.....323	41151-24.....332
34440-03.....305	34470-10.....310	34545-22.....318	34628-01.....323	41155-20.....333
34440-16.....308	34470-12.....310	34546-16.....318	34628-02.....323	41156-18.....333
34440-18.....308	34470-14.....310	34546-18.....318	34628-15.....323	41158-01.....333
34440-20.....308	34470-15.....310	34547-01.....320/1	34628-25.....323	41158-02.....333
34440-25.....308	34470-16.....310	34547-02.....320/2	34628-35.....323	41158-03.....333
34440-28.....308	34470-20.....310	34547-03.....320/1	34629-01.....323	41161-01.....333
34440-30.....308	34470-22.....310	34547-23.....320/1	34632-25.....324	41161-02.....333
34441-16.....308	34470-25.....310	34547-28.....320/2	34634-35.....324	41161-03.....333
34441-18.....308	34470-30.....310	34548-18.....318	34637-23.....325	41161-04.....333
34441-20.....308	34480-01.....311	34549-14.....318	34639-22.....325	41161-05.....333
34441-25.....308	34480-02.....311	34550-13.....318	34640-18.....325	41210-23.....334
34441-28.....308	34480-03.....311	34550-18.....318	35548-18.....320/3	41211-23.....334
34441-30.....308	34492-01.....311	34551-17.....318	41011-15.....326	41213-23.....334
34442-16.....309	34492-02.....311	34552-16.....319	41011-19.....326	41221-00.....334
34442-18.....309	34492-03.....311	34554-15.....319	41015-23.....326	41222-00.....334
34442-20.....309	34502-15.....312	34554-18.....319	41015-26.....326	41223-00.....334
34442-25.....309	34502-21.....312	34554-20.....319	41017-23.....326	41224-00.....334
34442-28.....309	34514-18.....312	34555-15.....319	41017-26.....326	41230-19.....335
34442-30.....309	34514-27.....312	34555-18.....319	41019-14.....326	41231-19.....335
34443-16.....309	34515-01.....313	34555-20.....319	41020-00.....326	41232-19.....335
34443-18.....309	34515-02.....313	34556-18.....319	41021-00.....326	41233-19.....335
34443-20.....309	34515-09.....312	34557-22.....320	41025-01.....327	41234-19.....335
34443-25.....309	34515-10.....312	34557-25.....320	41025-02.....327	41236-19.....335
34443-28.....309	34515-11.....312	34557-30.....320	41026-35.....327	41237-19.....335
34443-30.....309	34515-12.....312	34558-32.....320	41026-50.....327	41238-19.....335
34444-16.....309	34515-13.....312	34559-47.....320	41027-00.....327	41239-19.....335
34444-18.....309	34515-15.....312	34560-57.....320	41028-00.....327	41242-19.....336
34444-20.....309	34515-20.....312	34562-24.....321	41051-20.....328	41243-19.....336
34444-25.....309	34518-01.....312	34562-32.....321	41052-20.....328	41244-19.....336
34444-28.....309	34518-02.....312	34562-48.....321	41053-20.....328	41245-19.....336
34444-30.....309	34518-03.....312	34562-64.....321	41054-20.....328	41250-11.....336
34445-16.....309	34519-01.....313	34570-01.....321	41056-18.....328	41250-15.....336

41250-18.....336	41307-04.....338	41512-04.....344	41604-62.....349	41614-58T.....352
41253-07.....336	41307-05.....338	41512-05.....344	41604-62T.....349	41614-65.....352
41253-11.....336	41307-06.....338	41513-01.....344	41604-79.....349	41614-65T.....352
41253-15.....336	41401-16.....339	41513-02.....344	41604-79T.....349	41614-72.....352
41253-18.....336	41405-17.....339	41513-03.....344	41604-87.....349	41614-72T.....352
41254-06.....337	41405-27.....339	41513-04.....344	41604-87T.....349	41615-49.....352
41254-10.....337	41406-01.....339	41513-05.....344	41605-10.....350	41615-49T.....352
41254-13.....337	41406-02.....339	41514-01.....344	41605-10T.....350	41615-50.....352
41254-16.....337	41420-01.....340	41514-02.....344	41605-12.....350	41615-50T.....352
41254-19.....337	41420-02.....340	41514-03.....344	41605-12T.....350	41615-51.....352
41254-25.....337	41420-03.....340	41514-04.....344	41605-13.....350	41615-51T.....352
41254-32.....337	41421-01.....340	41514-05.....344	41605-13T.....350	41616-79.....353
41254-38.....337	41421-02.....340	41515-01.....344	41606-62.....350	41616-79T.....353
41290-21.....337	41421-03.....340	41515-02.....344	41606-62T.....350	41616-91.....353
41294-40.....337	41422-01.....340	41515-03.....344	41606-65.....350	41616-91T.....353
41295-06.....337	41422-02.....340	41515-04.....344	41606-65T.....350	41617-10.....353
41295-07.....337	41422-03.....340	41515-05.....344	41606-78.....350	41617-10T.....353
41295-08.....337	41430-01.....340	41520-03.....344/1	41606-78T.....350	41617-65.....353
41295-09.....337	41430-02.....340	41520-05.....344/1	41606-84.....350	41617-65T.....353
41295-10.....337	41430-03.....340	41522-03.....344/1	41606-84T.....350	41617-72.....353
41295-11.....337	41431-01.....340	41522-05.....344/1	41607-56.....350	41617-72T.....353
41295-12.....337	41431-02.....340	41524-03.....344/1	41607-56T.....350	41617-78.....353
41295-15.....337	41431-03.....340	41524-05.....344/1	41607-57.....350	41617-78T.....353
41297-06.....337	41432-01.....340	41526-03.....344/1	41607-57T.....350	41618-55.....353
41297-07.....337	41432-02.....340	41526-05.....344/1	41607-58.....350	41618-55T.....353
41297-08.....337	41432-03.....340	41527-03.....344/1	41607-58T.....350	41618-56.....353
41297-09.....337	41440-01.....340	41527-05.....344/1	41607-59.....350	41618-56T.....353
41297-10.....337	41440-02.....340	41529-03.....344/1	41607-59T.....350	41618-57.....353
41297-11.....337	41440-03.....340	41529-05.....344/1	41607-60.....350	41618-57T.....353
41297-12.....337	41441-01.....340	41540-02.....344/2	41607-60T.....350	41618-79.....353
41298-12.....337	41441-02.....340	41540-03.....344/2	41607-72.....350	41618-79T.....353
41299-03.....336	41441-03.....340	41540-04.....344/2	41607-72T.....350	41618-88.....353
41299-05.....336	41442-01.....340	41540-05.....344/2	41607-73.....350	41618-88T.....353
41299-07.....336	41442-02.....340	41542-02.....344/2	41607-73T.....350	41619-00.....353
41300-02.....337/1	41442-03.....340	41542-03.....344/2	41607-82.....350	41619-00T.....353
41300-03.....337/1	41443-26.....341	41542-04.....344/2	41607-82T.....350	41620-58.....354
41300-04.....337/1	41444-01.....341	41542-05.....344/2	41608-57.....350	41620-58T.....354
41300-05.....337/1	41444-02.....341	41600-62.....349	41608-57T.....350	41620-59.....354
41301-15.....337/1	41444-03.....341	41600-62T.....349	41608-80.....350	41620-59T.....354
41301-20.....337/1	41445-25.....341/1	41600-70.....349	41608-80T.....350	41620-60.....354
41301-25.....337/1	41446-00.....341/1	41600-70T.....349	41609-70.....350	41620-60T.....354
41301-35.....337/1	41447-27.....341/2	41600-78.....349	41609-70T.....350	41620-61.....354
41302-02.....337/1	41448-02.....342	41600-78T.....349	41610-61.....351	41620-61T.....354
41303-09.....337/2	41448-03.....342	41600-92.....349	41610-61T.....351	41620-62.....354
41303-12.....337/2	41448-04.....342	41600-92T.....349	41610-68.....351	41620-62T.....354
41303-15.....337/2	41449-01.....342	41601-10.....349	41610-68T.....351	41620-63.....354
41303-18.....337/2	41449-02.....342	41601-10T.....349	41610-70.....351	41620-63T.....354
41303-25.....337/2	41449-03.....342	41601-11.....349	41610-70T.....351	41620-70.....354
41303-30.....337/2	41451-01.....343	41601-11T.....349	41611-74.....351	41620-70T.....354
41303-45.....337/2	41451-02.....343	41601-13.....349	41611-74T.....351	41620-78.....354
41304-06.....338	41451-03.....343	41601-13T.....349	41611-87.....351	41620-78T.....354
41304-08.....338	41452-01.....343	41602-60.....349	41611-87T.....351	41620-88.....354
41304-10.....338	41452-02.....343	41602-60T.....349	41611-92.....351	41620-88T.....354
41305-05.....338	41452-03.....343	41602-68.....349	41611-92T.....351	41621-58.....354
41305-06.....338	41453-01.....343	41602-68T.....349	41612-07.....351	41621-58T.....354
41305-07.....338	41453-02.....343	41602-75.....349	41612-07T.....351	41621-62.....354
41305-08.....338	41453-03.....343	41602-75T.....349	41612-09.....351	41621-62T.....354
41305-09.....338	41458-20.....343	41602-87.....349	41612-09T.....351	41622-58.....354
41305-10.....338	41510-01.....344	41602-87T.....349	41612-11.....351	41622-58T.....354
41305-12.....338	41510-02.....344	41603-55.....349	41612-11T.....351	41622-62.....354
41305-15.....338	41510-03.....344	41603-55T.....349	41612-12.....351	41622-62T.....354
41305-18.....338	41510-04.....344	41603-61.....349	41612-12T.....351	41623-56.....354
41305-20.....338	41510-05.....344	41603-61T.....349	41612-62.....351	41623-56T.....354
41305-25.....338	41511-01.....344	41603-65.....349	41612-62T.....351	41624-56.....354
41305-30.....338	41511-02.....344	41603-65T.....349	41613-74.....352	41624-56T.....354
41306-05.....337/1	41511-03.....344	41603-74.....349	41613-74T.....352	41625-56.....354
41306-07.....337/1	41511-04.....344	41603-74T.....349	41613-84.....352	41625-56T.....354
41306-09.....337/1	41511-05.....344	41604-54.....349	41613-84T.....352	41626-56.....354
41306-12.....337/1	41512-01.....344	41604-54T.....349	41613-96.....352	41626-56T.....354
41307-00.....338	41512-02.....344	41604-58.....349	41613-96T.....352	41627-33.....355
41307-03.....338	41512-03.....344	41604-58T.....349	41614-58.....352	41627-33T.....355

41627-40.....355	41648-07.....358	41830-30.....368/1	43251-12.....373	43441-02.....378
41627-40T.....355	41648-09.....358	41832-32.....368/1	43253-12.....373	43443-13.....378
41628-33.....355	41648-11.....358	41842-42.....368/4	43256-12.....373	43445-13.....378
41628-33T.....355	41649-07.....359	41842-44.....368/4	43258-12.....373	43447-13.....378
41628-40.....355	41649-09.....359	41842-46.....368/4	43262-12.....373	43449-01.....378
41628-40T.....355	41649-11.....359	41843-50.....368/4	43271-11.....373	43449-02.....378
41628-46.....355	41650-07.....359	41850-41.....368/4	43273-13.....373	43461-13.....378
41628-46T.....355	41650-09.....359	41860-14.....369	43304-12.....374	43462-13.....378
41629-32.....355	41650-11.....359	41860-17.....369	43305-12.....374	43482-20.....378
41629-32T.....355	41651-07.....359	41860-20.....369	43308-12.....374	43485-13.....378
41629-38.....355	41651-09.....359	41870-08.....369	43309-12.....374	43487-14.....378
41629-38T.....355	41651-11.....359	41870-11.....369	43310-13.....374	43501-06.....379
41630-36.....355	41652-07.....359	41870-14.....369	43311-13.....374	43501-10.....379
41630-36T.....355	41652-09.....359	41870-17.....369	43314-13.....374	43501-12.....379
41630-38.....355	41652-11.....359	41880-01.....369	43321-12.....374	43511-13.....379
41630-38T.....355	41653-18.....360	41880-02.....369	43325-13.....374	43513-14.....379
41631-36.....355	41654-18.....360	41880-03.....369	43327-12.....374	43515-14.....379
41631-36T.....355	41655-18.....360	43101-03.....370	43330-13.....374	43517-09.....379
41631-40.....355	41656-18.....360	43101-04.....370	43331-11.....374	43521-12.....379
41631-40T.....355	41657-17.....360	43104-07.....370	43332-12.....374	43523-12.....379
41631-44.....355	41657-21.....360	43105-06.....370	43334-12.....374	43524-10.....379
41631-44T.....355	41657-23.....360	43106-05.....370	43336-12.....374	43525-05.....379
41632-36.....355	41658-17.....360	43107-08.....370	43340-13.....374	43525-07.....379
41632-36T.....355	41658-21.....360	43109-07.....370	43342-12.....374	43525-10.....379
41633-35.....355	41658-23.....360	43109-09.....370	43351-01.....375	43526-12.....379
41633-35T.....355	41659-17.....360	43110-08.....370	43351-02.....375	43542-12.....380
41633-40.....355	41659-21.....360	43111-07.....370	43351-03.....375	43544-12.....380
41633-40T.....355	41659-23.....360	43113-07.....370	43353-13.....375	43546-13.....380
41634-35.....355	41660-17.....360	43115-05.....370	43355-13.....375	43548-13.....380
41634-35T.....355	41660-21.....360	43121-07.....370	43357-13.....375	43583-07.....380
41634-60.....355	41660-23.....360	43123-07.....370	43363-01.....375	43589-13.....380
41634-60T.....355	41661-40.....361	43125-05.....370	43363-02.....375	43593-09.....380
41634-70.....355	41661-50.....361	43125-07.....370	43370-12.....375	43602-01.....381
41634-70T.....355	41662-50.....361	43127-08.....370	43372-13.....375	43602-02.....381
41635-57.....355	41663-01.....361	43128-08.....370	43373-13.....375	43602-03.....381
41635-57T.....355	41663-02.....361	43129-07.....371	43376-13.....375	43605-12.....381
41636-45.....355	41664-10.....362	43130-07.....371	43377-13.....375	43605-34.....381
41636-45T.....355	41664-14.....362	43132-08.....371	43380-13.....375	43605-56.....381
41637-33.....356	41665-10.....362	43133-08.....371	43381-13.....375	43608-12.....381
41637-33T.....356	41665-14.....362	43135-07.....371	43383-13.....375	43609-14.....381
41637-40.....356	41666-00.....362	43139-07.....371	43386-13.....375	43610-01.....381
41637-40T.....356	41667-30.....363	43140-08.....371	43387-02.....376	43610-02.....381
41638-38.....356	41667-50.....363	43141-08.....371	43388-02.....376	43613-00.....381
41638-38T.....356	41668-50.....363	43150-11.....371	43389-02.....376	43614-00.....381
41638-46.....356	41669-50.....363	43170-00.....371	43390-05.....376	43614-01.....381
41638-46T.....356	41670-50.....363	43170-01.....371	43391-13.....376	43614-12.....381
41639-44.....356	41672-01.....364	43170-02.....371	43402-05.....377	43614-23.....381
41639-44T.....356	41672-02.....364	43170-03.....371	43402-10.....377	43614-34.....381
41640-40.....356	41672-03.....364	43172-13.....371	43402-15.....377	43614-45.....381
41640-40T.....356	41672-04.....364	43180-01.....372	43402-18.....377	43614-56.....381
41641-07.....357	41674-50.....365	43180-02.....372	43402-20.....377	43614-67.....381
41641-09.....357	41674-80.....365	43180-03.....372	43402-25.....377	43614-78.....381
41641-11.....357	41675-50.....365	43181-01.....372	43402-35.....377	43802-07.....382
41642-07.....357	41675-80.....365	43181-02.....372	43402-40.....377	43803-07.....382
41642-09.....357	41676-50.....365	43181-03.....372	43402-45.....377	43804-07.....382
41642-11.....357	41676-80.....365	43183-13.....372	43404-10.....377	43805-07.....382
41643-07.....357	41677-50.....365	43185-13.....372	43404-20.....377	43810-10.....382
41643-09.....357	41677-80.....365	43187-13.....372	43404-24.....377	43811-10.....382
41643-11.....357	41678-50.....365	43202-01.....372	43404-30.....377	43813-10.....382
41644-07.....357	41678-80.....365	43202-02.....372	43404-35.....377	43820-10.....382
41644-09.....357	41679-25.....366	43202-03.....372	43407-13.....377	43821-10.....382
41644-11.....357	41680-00.....366	43210-01.....372	43410-01.....377	43823-10.....382
41645-07.....358	41801-01.....368	43210-02.....372	43410-02.....377	43830-10.....383
41645-09.....358	41802-00.....368/3	43210-03.....372	43412-01.....377	43831-10.....383
41645-11.....358	41802-02.....368	43213-12.....372	43412-02.....377	43833-10.....383
41646-07.....358	41803-01.....368/2	43218-12.....373	43414-02.....378	43840-10.....383
41646-09.....358	41807-00.....368/2	43221-11.....373	43420-01.....378	43841-10.....383
41646-11.....358	41810-10.....368/2	43228-12.....373	43420-02.....378	43843-10.....383
41647-07.....358	41821-21.....368/1	43231-12.....373	43420-03.....378	43850-08.....383
41647-09.....358	41822-22.....368/1	43233-13.....373	43424-13.....378	43851-08.....383
41647-11.....358	41826-26.....368/1	43245-12.....373	43441-01.....378	43852-08.....383

43853-08.....383	44166-07.....392	45015-65.....399	45098-20.....407	45194-04.....410
43855-07.....384	44181-10.....392	45018-00.....399	45098-50.....407	45201-11.....410
43857-07.....384	44190-08.....392	45018-50.....399	45099-01.....407	45201-13.....410
43861-07.....384	44202-08.....392	45018-60.....399	45099-02.....407	45203-11.....410
43863-07.....384	44210-10.....392	45018-70.....399	45099-05.....407	45206-14.....410
43865-07.....384	44220-10.....392	45018-80.....399	45099-10.....407	45206-16.....410
43869-07.....384	44240-09.....393	45020-01.....400	45099-20.....407	45207-16.....410
43881-07.....384	44242-09.....393	45020-02.....400	45099-50.....407	45208-14.....410
43883-07.....384	44246-09.....393	45020-03.....400	45109-00.....407	45220-16.....411
43885-07.....384	44254-09.....393	45020-04.....400	45110-00.....407	45222-17.....411
43887-07.....384	44256-09.....393	45030-04.....401	45110-01.....407	45225-02.....411
43891-09.....385	44258-09.....393	45030-06.....401	45110-02.....407	45243-14.....411
43902-09.....385	44265-10.....393	45030-07.....401	45110-03.....407	45245-12.....411
43903-09.....385	44267-10.....393	45030-08.....401	45110-04.....407	45246-12.....411
43907-10.....385	44274-11.....393	45030-10.....401	45110-05.....407	45246-14.....411
43909-10.....385	44300-00.....394	45036-03.....402	45111-00.....407	45251-10.....412
43914-10.....385	44301-00.....394	45036-06.....402	45112-00.....407	45253-11.....412
43916-10.....385	44310-00.....394	45036-07.....402	45112-01.....407	45255-08.....412
43920-11.....385	44311-00.....394	45036-08.....402	45112-02.....407	45257-08.....412
43924-11.....386	44320-00.....394	45036-09.....401	45112-03.....407	45261-08.....412
43926-11.....386	44330-00.....394	45036-10.....401	45112-04.....407	45261-14.....412
43940-05.....386	44340-00.....394	45060-01.....403	45112-05.....407	45261-16.....412
43940-08.....386	44350-00.....394	45060-02.....403	45114-00.....407	45263-08.....412
43942-05.....386	44370-00.....394/1	45060-03.....403	45115-00.....407	45263-14.....412
43942-08.....386	44371-00.....394/1	45060-04.....403	45115-01.....407	45265-08.....412
43944-07.....387	44372-00.....394/1	45060-05.....403	45115-02.....407	45267-20.....412
43946-07.....387	44373-00.....394/1	45061-00.....403	45115-03.....407	45267-25.....412
43948-10.....387	44374-00.....394/1	45070-01.....403	45115-04.....407	45267-30.....412
43950-10.....387	44380-00.....394/2	45070-02.....403	45115-05.....407	45269-30.....412
43952-10.....387	44390-00.....394/2	45070-03.....403	45116-00.....407	45271-08.....412
43953-10.....387	44404-00.....394/2	45070-04.....403	45117-00.....407	45273-08.....412
43955-10.....387	44404-00G.....394/2	45070-05.....403	45117-01.....407	45275-08.....412
43956-10.....387	44406-00.....394/2	45070-06.....403	45117-02.....407	45310-40.....413
44015-20.....389	44406-00G.....394/2	45071-00.....403	45117-03.....407	45312-55.....413
44015-27.....389	44408-00.....395	45072-01.....404	45117-04.....407	45313-55.....413
44017-08.....389	44420-09.....395	45073-01.....404	45117-05.....407	45315-55.....413
44046-11.....389	44422-09.....395	45073-02.....404	45133-01.....408	45317-55.....413
44050-11.....389	44424-08.....395	45073-03.....404	45133-02.....408	45320-70.....413
44052-11.....389	44425-10.....395	45073-04.....404	45133-03.....408	45321-70.....413
44054-09.....389	44426-09.....395	45073-05.....404	45133-04.....408	45322-70.....413
44066-09.....390	44428-09.....395	45073-06.....404	45133-05.....408	45350-40.....413
44067-09.....390	45009-00.....399	45074-01.....404	45150-18.....408	45350-70.....413
44068-09.....390	45009-02.....399	45075-00.....404	45151-16.....408	45352-40.....413
44069-09.....390	45009-03.....399	45076-01.....404	45152-01.....408	45353-60.....413
44074-10.....390	45009-04.....399	45080-00.....405	45152-02.....408	45355-60.....413
44076-05.....390	45010-00.....399	45090-00.....405	45153-16.....408	45357-40.....413
44076-10.....390	45010-20.....399	45090-02.....405	45160-15.....408	45359-40.....413
44078-05.....390	45010-30.....399	45090-03.....405	45162-18.....408	45360-35.....413
44078-10.....390	45010-45.....399	45090-04.....405	45164-17.....408	45362-45.....414
44101-07.....390	45010-55.....399	45090-05.....405	45165-17.....408	45363-45.....414
44103-09.....391	45010-65.....399	45090-06.....405	45171-12.....409	45365-45.....414
44106-10.....391	45010-75.....399	45090-08.....405	45180-01.....409	45367-50.....414
44109-10.....391	45011-00.....399	45091-00.....406	45180-02.....409	45369-50.....414
44111-10.....391	45011-03.....399	45091-01.....406	45180-03.....409	45370-50.....414
44114-10.....391	45011-04.....399	45091-02.....406	45181-13.....409	45371-40.....414
44115-10.....391	45011-05.....399	45091-03.....406	45184-16.....409	45373-30.....414
44117-10.....391	45011-07.....399	45091-04.....406	45185-15.....409	45375-60.....414
44119-10.....391	45011-08.....399	45091-15.....406	45190-01.....409	45377-60.....414
44121-10.....391	45012-00.....399	45091-17.....406	45190-02.....409	45381-30.....414
44125-06.....391	45012-40.....399	45091-22.....406	45192-01.....409	45383-30.....414
44127-06.....391	45012-55.....399	45096-50.....406	45192-02.....409	45385-01.....414
44129-07.....391	45012-65.....399	45096-75.....406	45192-03.....409	45385-02.....414
44150-01.....392	45012-75.....399	45097-01.....406	45192-04.....409	45387-01.....414
44150-03.....392	45014-00.....399	45097-02.....406	45192-05.....409	45387-02.....414
44150-05.....392	45014-45.....399	45097-03.....406	45192-06.....409	45390-35.....415
44150-10.....392	45014-55.....399	45097-10.....406	45193-01.....409	45390-50.....415
44150-15.....392	45014-65.....399	45097-15.....406	45193-02.....409	45391-35.....415
44151-05.....392	45014-75.....399	45098-01.....407	45193-03.....409	45392-35.....415
44151-10.....392	45015-00.....399	45098-02.....407	45194-01.....410	45393-50.....415
44151-15.....392	45015-45.....399	45098-05.....407	45194-02.....410	45394-50.....415
44164-10.....392	45015-55.....399	45098-10.....407	45194-03.....410	45400-01.....416

45400-02.....416	45751-16.....420	47197-01.....426	47350-26.....433/2	47470-07.....441
45400-03.....416	45753-16.....420	47197-02.....426	47351-26.....433/2	47471-02.....441
45401-25.....416	45755-16.....420	47223-01.....426	47352-24.....433/2	47471-03.....441
45402-10.....416	45757-16.....420	47223-02.....426	47355-03.....433/2	47471-04.....441
45403-13.....416	45760-01.....420	47223-03.....426	47370-16.....434	47471-05.....441
45404-13.....416	45760-02.....420	47223-04.....426	47371-16.....434	47471-06.....441
45410-01.....417	45762-01.....420	47223-05.....426	47372-16.....434	47471-07.....441
45411-01.....417	45762-02.....420	47224-01.....426	47373-16.....434	47471-08.....441
45412-01.....417	45766-35.....420	47224-02.....426	47374-16.....434	47471-10.....441
45413-01.....417	45766-40.....420	47224-03.....426	47375-16.....434	47471-12.....441
45414-01.....417	45766-45.....420	47224-04.....426	47375-19.....434	47472-10.....441
45701-01.....418	45766-50.....420	47224-05.....426	47376-16.....435	47472-12.....441
45701-02.....418	45802-16.....420	47235-05.....427	47379-16.....435	47472-14.....441
45703-15.....418	45803-16.....420	47235-07.....427	47380-15.....435	47472-16.....441
45704-15.....418	45805-16.....420	47235-09.....427	47382-15.....435	47473-01.....442
45705-15.....418	45807-20.....420	47235-11.....427	47384-15.....435	47473-02.....442
45706-35.....418	47050-01.....421	47237-01.....427	47385-15.....435	47473-03.....442
45709-10.....418	47050-02.....421	47237-02.....427	47386-01.....435	47474-01.....442
45709-14.....418	47050-03.....421	47237-03.....427	47386-02.....435	47474-02.....442
45709-16.....418	47050-04.....421	47239-01.....427	47387-01.....435	47474-03.....442
45709-20.....418	47050-05.....421	47239-02.....427	47387-02.....435	47481-05.....442/1
45709-26.....418	47050-06.....421	47240-19.....427	47390-03.....436	47482-05.....442/1
45709-28.....418	47050-07.....421	47242-00.....427	47390-04.....436	47484-04.....442/1
45709-30.....418	47060-01.....421	47242-01.....427	47390-05.....436	47484-06.....442/1
45710-15.....419	47060-02.....421	47251-21.....428	47392-03.....436	47484-08.....442/1
45711-15.....419	47060-03.....421	47255-01.....428	47392-04.....436	47486-16.....442/1
45713-15.....419	47102-01.....421	47255-02.....428	47392-05.....436	47487-16.....442/1
45715-17.....419	47102-02.....421	47256-20.....428	47410-04.....437	47489-16.....442/1
45720-03.....419	47102-03.....421	47303-03.....428	47410-05.....437	47502-16.....443
45720-06.....419	47103-01.....422	47303-04.....428	47410-16.....437	47504-18.....443
45720-10.....419	47103-02.....422	47303-05.....428	47411-16.....437	47507-17.....443
45722-03.....419	47103-03.....422	47303-06.....428	47413-19.....437	47507-19.....443
45722-06.....419	47112-01.....421	47304-01.....429	47414-21.....437	47511-21.....443
45722-10.....419	47112-02.....421	47304-02.....429	47415-18.....437	47513-21.....443
45722-12.....419	47112-03.....421	47304-03.....429	47417-19.....437	47514-16.....443
45722-15.....419	47113-03.....421	47304-04.....429	47419-19.....437	47516-16.....443
45722-20.....419	47116-13.....423	47305-01.....429	47420-01.....438	47518-21.....444
45722-25.....419	47118-13.....423	47305-02.....429	47420-02.....438	47520-21.....444
45724-03.....419	47120-35.....423	47305-03.....429	47420-03.....438	47521-01.....444
45724-06.....419	47120-50.....423	47311-10.....430	47420-04.....438	47521-02.....444
45724-10.....419	47120-75.....423	47311-25.....430	47420-20.....438	47521-03.....444
45724-12.....419	47120-90.....423	47311-30.....430	47421-21.....438	47522-01.....445
45724-15.....419	47124-35.....423	47315-00.....430	47421-23.....439	47522-04.....445
45724-20.....419	47124-50.....423	47316-00.....430	47422-22.....439	47522-05.....445
45724-25.....419	47124-75.....423	47316-16.....431	47423-22.....439	47522-07.....445
45725-05.....419	47124-90.....423	47317-00.....430	47424-16.....439	47522-09.....445
45725-10.....419	47139-12.....423	47317-11.....431	47425-19.....439	47523-01.....446
45730-03.....419	47139-14.....423	47317-65.....431	47426-22.....439	47523-02.....446
45730-06.....419	47139-16.....423	47317-70.....431	47428-21.....439	47526-16.....446
45730-10.....419	47139-18.....423	47317-90.....431	47430-22.....439	47527-01.....446
45732-03.....419	47151-15.....424	47318-11.....431	47450-04.....439	47529-16.....446
45732-06.....419	47151-18.....424	47318-65.....431	47451-04.....439	47532-19.....446
45732-10.....419	47154-20.....424	47318-70.....431	47454-04.....440	47533-19.....446
45733-05.....419	47155-20.....424	47318-90.....431	47454-07.....440	47534-19.....446
45733-10.....419	47158-20.....424	47319-35.....432	47454-09.....440	47535-01.....446
45735-05.....419	47159-20.....424	47319-45.....432	47454-12.....440	47535-02.....446
45735-10.....419	47161-16.....424	47323-19.....430	47455-06.....440	47540-16.....447
45736-15.....419	47161-20.....424	47325-19.....430	47458-04.....440	47541-14.....447
45737-15.....419	47167-18.....425	47331-20.....433	47458-07.....440	47542-12.....447
45741-03.....419	47169-18.....425	47331-25.....433	47458-09.....440	47551-16.....447
45741-06.....419	47171-14.....425	47331-30.....433	47458-12.....440	47551-16L.....447
45741-10.....419	47173-14.....425	47331-40.....433	47460-04.....440	47552-16.....447
45743-03.....419	47181-18.....425	47332-20.....433	47460-07.....440	47553-15.....447/1
45743-06.....419	47185-18.....425	47332-25.....433	47460-12.....440	47554-01.....447/1
45743-10.....419	47191-01.....425	47332-30.....433	47461-00.....440	47554-02.....447/1
45745-03.....419	47191-02.....425	47332-40.....433	47463-10.....440	47554-03.....447/1
45745-06.....419	47191-03.....425	47342-25.....433	47463-12.....440	47555-08.....447/1
45745-10.....419	47191-04.....425	47342-30.....433	47463-14.....440	47556-16.....447/1
45747-03.....419	47192-16.....426	47342-40.....433	47470-04.....441	47557-17.....447/1
45747-06.....419	47195-01.....426	47345-15.....433/1	47470-05.....441	47558-15.....448
45747-10.....419	47195-02.....426	47347-20.....433/1	47470-06.....441	47559-20.....448

47560-18.....448	49274-13.....454	49640-07.....462	51187-19.....467	53230-03.....473
47562-18.....448	49274-15.....454	49640-09.....462	51191-19.....467	53230-04.....473
47563-22.....448	49287-02.....455	49650-06.....462	51193-19.....467	53230-05.....473
47564-16.....448	49287-03.....455	49650-07.....462	51202-19.....467	53230-06.....473
47565-10.....448	49287-04.....455	49650-09.....462	51203-19.....467	53230-07.....473
47566-12.....448	49287-05.....455	49650-11.....462	51205-18.....467	53230-08.....473
47571-23.....449	49288-02.....455	49660-18.....463	51205-23.....467	53240-01.....473
47572-23.....449	49288-03.....455	49665-24.....463	51207-21.....467	53240-02.....473
47573-23.....449	49288-04.....455	49670-19.....463	51209-20.....467	53240-03.....473
47575-23.....449	49288-05.....455	49670-20.....463	51210-20.....468	53240-04.....473
47601-21.....449	49310-00.....455	49670-23.....463	51211-21.....468	53240-05.....473
47607-01.....449	49310-01.....455	49671-01.....463/1	51213-21.....468	53240-06.....473
47607-02.....449	49310-02.....455	49671-01CL.....463/1	51219-22.....468	53240-07.....473
47607-03.....449	49310-03.....455	49671-02.....463/1	51250-28.....468	53240-08.....473
47607-04.....449	49310-04.....455	49671-02CL.....463/1	51252-28.....468	53250-01.....473
47607-05.....449	49310-05.....455	49673-01.....463/2	51256-28.....468	53250-02.....473
47607-06.....449	49310-10.....455	49673-02.....463/2	51257-40.....468	53250-03.....473
47620-00.....450	49310-12.....455	49673-03.....463/2	51257-50.....468	53250-04.....473
47620-01.....450	49315-00.....456	49673-04.....463/2	51259-03.....468	53250-05.....473
47620-02.....450	49315-01.....456	49675-18.....463/3	51259-04.....468	53250-06.....473
47620-03.....450	49315-02.....456	49680-10.....463/3	51259-05.....468	53250-07.....473
47620-04.....450	49315-03.....456	49680-20.....463/3	51260-00.....469	53250-08.....473
47620-05.....450	49315-10.....456	49685-21.....463/3	51270-00.....470	53260-01.....473
47620-06.....450	49317-00.....456	49691-15.....463/3	51270-01.....470	53260-02.....473
47630-00.....450	49317-01.....456	49692-15.....463/3	51270-02.....470	53260-03.....473
47630-01.....450	49317-02.....456	49694-25.....463/4	51270-03.....470	53260-04.....473
47630-02.....450	49317-03.....456	49694-25CL.....463/4	51270-04.....470	53260-05.....473
47630-03.....450	49317-10.....456	49695-01.....463/5	51290-02.....470	53260-06.....473
47630-04.....450	49320-00.....457	49695-02.....463/5	51290-05.....470	53260-07.....473
47636-01.....450	49320-01.....457	49696-18.....463/6	51290-10.....470	53260-08.....473
47636-02.....450	49320-02.....457	49700-01.....464	51290-20.....470	53270-08.....473
47636-03.....450	49320-03.....457	49700-02.....464	51291-00.....470	53270-10.....473
47636-04.....450	49320-10.....457	49705-08.....464/1	51292-00.....470	53270-12.....473
47641-01.....450	49320-20.....457	49705-12.....464/1	51293-00.....470	53270-14.....473
47641-02.....450	49340-00.....457	49705-16.....464/1	51293-45.....470	53270-16.....473
47641-03.....450	49342-01.....458	49705-20.....464/1	51293-90.....470	53270-18.....473
47642-01.....450	49342-02.....458	49710-04.....464/2	53101-22.....471	53270-20.....473
47642-02.....450	49342-03.....458	49710-06.....464/2	53102-20.....471	53270-22.....473
47642-03.....450	49342-04.....458	49710-08.....464/2	53103-22.....471	53270-24.....473
49102-16.....451	49342-05.....458	49711-04.....464/2	53111-18.....471	53270-26.....473
49103-17.....451	49345-01.....458	49711-06.....464/2	53115-01.....471	53270-28.....473
49104-15.....451	49345-02.....458	49713-06.....464/2	53115-02.....471	53270-30.....473
49105-16.....451	49345-03.....458	49713-08.....464/2	53115-03.....471	53272-08.....473
49106-01.....451	49345-04.....458	51103-18.....465	53115-04.....471	53272-10.....473
49106-02.....451	49345-05.....458	51103-20.....465	53121-24.....471	53272-12.....473
49107-19.....451	49360-10.....459	51103-22.....465	53130-00.....472	53272-14.....473
49108-15.....451	49400-01.....459	51109-24.....465	53131-20.....472	53272-16.....473
49109-19.....451	49501-22.....459	51111-23.....465	53132-20.....472	53272-18.....473
49110-19.....452	49501-23.....459	51131-22.....465	53132-30.....472	53272-20.....473
49111-15.....452	49501-24.....459	51133-23.....465	53132-40.....472	53272-22.....473
49115-01.....452	49503-22.....459	51134-21.....465	53132-50.....472	53272-24.....473
49115-02.....452	49503-23.....459	51135-01.....465	53132-60.....472	53272-26.....473
49117-11.....452	49503-24.....459	51135-02.....465	53150-00.....472	53272-28.....473
49119-14.....453	49605-07.....460	51139-25.....465	53152-00.....472	53272-30.....473
49230-11.....453	49605-10.....460	51143-24.....465	53154-00.....472	53274-12.....473
49231-12.....453	49605-11.....460	51151-19.....465	53155-00.....472	53276-10.....473
49231-14.....453	49605-12.....460	51165-22.....466	53157-00.....472	53280-01.....474
49231-16.....453	49605-14.....460	51167-22.....466	53158-02.....472	53280-02.....474
49235-19.....453	49605-16.....460	51168-23.....466	53158-03.....472	53280-03.....474
49250-16.....453	49610-12.....460	51169-23.....466	53160-02.....472	53280-04.....474
49250-18.....453	49610-13.....460	51170-24.....466	53160-03.....472	53280-05.....474
49255-16.....453	49610-16.....460	51171-22.....466	53162-00.....472	53280-06.....474
49255-99.....453	49613-10.....461	51172-19.....466	53164-01.....472	53280-07.....474
49265-12.....454	49615-12.....461	51173-21.....466	53164-02.....472	53280-08.....474
49265-14.....454	49620-15.....461/1	51174-21.....466	53166-00.....472	53280-09.....474
49267-12.....454	49623-16.....461/1	51177-23.....466	53170-00.....472	53280-10.....474
49270-16.....454	49627-01.....461/1	51178-21.....466	53175-00.....472	53280-11.....474
49270-19.....454	49630-02.....461/1	51179-17.....466	53177-01.....472	53290-01.....475
49272-13.....454	49631-00.....461/2	51181-19.....467	53177-02.....472	53290-02.....475
49274-09.....454	49635-18.....462	51183-19.....467	53230-01.....473	53290-03.....475
49274-11.....454	49640-05.....462	51185-19.....467	53230-02.....473	53290-04.....475



53290-05.....475	57244-13.....483	61021-24.....499	61063-16.....512	61372-08.....523
53290-06.....475	57245-13.....484	61022-01.....499	61138-14.....513	61372-09.....523
53290-07.....475	57246-16.....484	61022-02.....499	61138-16.....513	61373-01.....523
53290-08.....475	57246-21.....484	61022-24.....499/1	61138-18.....513	61373-02.....523
55111-13.....476	57247-95.....485	61022-28.....499/2	61138-20.....513	61373-03.....523
55111-14.....476	57248-14.....485	61023-25.....500	61139-14.....513	61373-04.....523
55113-14.....476	57249-01.....485	61023-26.....500	61139-16.....513	61373-05.....523
55115-07.....476	57251-15.....486	61024-01.....501	61139-18.....513	61373-06.....523
55116-15.....476	57252-19.....486	61024-02.....501	61139-20.....513	61373-07.....523
55117-17.....476	57260-02.....487	61024-24.....501/1	61140-17.....514	61373-08.....523
55118-16.....477	57260-03.....487	61024-27.....501/2	61141-16.....514	61373-09.....523
55119-16.....477	57260-04.....487	61025-20.....502	61143-15.....514	61374-01.....523
55120-15.....477	57260-06.....487	61025-24.....502	61145-15.....514	61374-02.....523
55122-16.....477	57260-09.....487	61025-25.....502	61147-17.....514	61374-03.....523
55124-16.....477	57264-16.....487	61025-26.....502	61149-17.....515	61374-04.....523
55151-05.....477	57265-00.....487/1	61025-27.....502	61151-17.....515	61374-05.....523
55151-07.....477	57266-13.....488	61026-01.....503	61153-16.....515	61374-06.....523
55151-09.....477	57270-00.....489	61026-02.....503	61153-17.....515	61374-07.....523
55220-04.....479	57270-65.....489	61026-03.....503	61156-16.....515	61374-08.....523
55220-05.....479	57270-75.....489	61026-04.....503	61156-17.....515	61374-09.....523
55220-06.....479	57270-80.....489	61027-23.....504	61156-18.....515	61460-15.....524
55220-07.....479	57280-19.....489/1	61027-25.....504	61157-17.....516	61460-19.....524
55220-08.....479	57283-14.....489/1	61029-25.....504	61158-10.....516	61461-15.....524
55220-09.....479	57284-16.....489/1	61030-21.....505	61158-11.....516	61461-19.....524
55220-10.....479	57286-16.....489/1	61030-22.....505	61158-12.....517	61461-28.....525
55220-11.....479	57288-30.....489	61031-17.....505	61159-12.....517	61462-19.....524
55220-12.....479	57289-32.....489	61032-18.....506	61159-13.....517	61462-28.....525
55220-13.....479	57290-20.....490	61032-20.....506	61161-14.....517	61463-19.....524
55240-04.....479	57291-20.....490	61032-23.....506	61161-18.....517	61463-28.....525
55240-05.....479	57301-30.....490	61032-25.....506	61161-19.....517	61464-15.....524
55240-06.....479	57307-24.....490	61033-23.....506	61172-15.....518	61464-19.....524
55240-07.....479	57309-22.....490	61033-24.....506	61173-16.....518	61464-28.....525
55240-08.....479	57311-22.....490	61033-25.....506	61174-17.....518	61465-15.....524
55240-09.....479	57313-22.....490	61034-21.....507	61175-17.....518	61465-19.....524
55240-10.....479	57321-23.....491	61034-23.....507	61176-17.....518	61465-28.....525
55240-11.....479	57323-23.....491	61034-27.....507	61177-17.....518	61466-15.....524
55240-12.....479	57325-15.....491	61034-31.....507	61178-16.....519	61466-19.....524
55240-13.....479	57327-26.....491	61035-21.....507	61178-17.....519	61466-28.....525
55501-15.....479	57329-26.....491	61035-23.....507	61179-18.....519	61467-15.....524
55503-15.....479	61000-21.....492	61035-27.....507	61180-17.....519	61467-19.....524
55511-21.....479	61000-22.....492	61035-31.....507	61187-16.....519	61467-28.....525
55520-15.....479	61001-21.....492	61036-18.....508	61187-17.....519	61468-19.....524
55520-20.....479	61001-22.....492	61036-19.....508	61188-20.....520	61468-28.....525
55523-17.....479	61003-21.....492	61036-23.....508	61189-21.....520	61469-19.....524
57102-23.....480	61003-22.....492	61036-27.....508	61190-17.....520	61469-28.....525
57105-22.....480	61005-22.....493	61037-20.....508	61191-16.....520	61470-15.....524
57107-22.....480	61007-22.....493	61037-21.....508	61192-17.....520	61470-19.....524
57111-21.....480	61008-19.....493	61037-25.....508	61193-01.....520/1	61471-15.....524
57123-35.....480	61008-23.....493	61037-29.....508	61193-02.....520/1	61471-19.....524
57125-35.....480	61009-16.....494	61038-12.....509	61193-03.....520/1	61471-28.....525
57126-34.....481	61010-18.....494	61039-00.....509/1	61193-04.....520/1	61472-19.....524
57131-26.....481	61011-19.....494	61039-12.....509	61193-05.....520/1	61472-28.....525
57137-27.....481	61011-20.....494	61039-15.....509/1	61194-26.....520/2	61473-19.....524
57138-21.....481	61012-17.....495	61039-30.....509/1	61195-28.....520/2	61473-28.....525
57141-36.....481	61012-18.....495	61039-45.....509/1	61195-32.....520/3	61481-15.....524
57146-28.....481	61012-19.....495	61039-90.....509/1	61196-26.....520/4	61481-19.....524
57147-28.....481	61013-18.....495	61040-21.....510	61259-15.....521	61482-15.....524
57210-16.....482	61013-19.....495	61041-00.....509/1	61261-16.....521	61482-19.....524
57210-20.....482	61013-20.....495	61041-15.....509/1	61263-16.....521	61482-28.....525
57210-25.....482	61014-15.....495/1	61041-30.....509/1	61266-01.....522	61483-19.....524
57214-75.....482	61014-18.....495/1	61041-45.....509/1	61266-02.....522	61483-28.....525
57230-13.....482	61015-15.....495/2	61041-90.....509/1	61266-03.....522	61484-19.....524
57230-17.....482	61015-18.....495/2	61045-18.....511	61266-04.....522	61484-28.....525
57230-18.....482	61016-20.....495/2	61046-19.....511	61266-05.....522	61488-16.....526
57234-75.....482	61017-26.....496	61050-01.....510	61372-01.....523	61489-16.....526
57236-20.....483	61017-27.....496	61050-02.....510	61372-02.....523	61490-15.....526
57236-25.....483	61017-31.....496	61050-03.....510	61372-03.....523	61491-15.....526
57236-30.....483	61017-33.....496	61050-04.....510	61372-04.....523	61492-16.....526
57242-20.....483	61018-28.....497	61050-05.....510	61372-05.....523	61493-01.....527
57242-25.....483	61019-30.....498	61050-07.....510	61372-06.....523	61493-02.....527
57242-30.....483	61020-27.....498	61062-16.....512	61372-07.....523	61493-03.....527

61495-01.....527	63170-23.....533	65211-23.....540	67122-23.....551	67206-21.....554
61495-02.....527	63173-01.....533	65216-13.....540	67123-23.....551	67206-22.....554
61495-03.....527	63173-02.....533	65216-16.....540	67125-24.....551	67206-23.....554
61495-04.....527	63173-03.....533	65216-18.....540	67130-00.....552	67206-24.....554
61700-01.....528	63173-04.....533	65216-21.....540	67130-01.....552	67206-25.....554
61700-33.....528	63173-05.....533	65216-23.....540	67130-02.....552	67206-26.....554
61710-01.....528	63173-06.....533	65217-13.....540	67130-03.....552	67206-27.....554
61710-33.....528	63173-07.....533	65217-16.....540	67132-00.....552	67206-28.....554
61715-04.....528	63173-08.....533	65217-18.....540	67147-27.....552	67206-29.....554
61715-05.....528	63174-00.....268	65217-21.....540	67149-27.....552	67206-30.....554
61715-06.....528	63175-27.....534	65217-23.....540	67150-00.....552	67207-08.....554
61810-05.....529	63178-01.....534	65220-13.....540	67155-00.....552	67207-09.....554
61810-10.....529	63178-03.....534	65220-22.....540	67160-00.....552	67207-10.....554
61810-15.....529	63180-17.....534	65220-25.....540	67163-00.....553	67207-11.....554
61810-20.....529	63180-21.....534	65220-28.....540	67165-00.....553	67207-12.....554
61810-25.....529	63180-24.....534	65221-13.....540	67169-00.....553	67207-13.....554
61810-30.....529	63180-27.....534	65221-22.....540	67169-01.....553	67207-14.....554
61810-35.....529	63210-32.....534	65221-25.....540	67172-20.....553/1	67207-15.....554
61810-40.....529	63231-01.....535	65221-28.....540	67172-28.....553/1	67207-16.....554
61810-45.....529	63231-02.....535	65226-22.....540	67175-08.....553/1	67207-17.....554
61810-50.....529	63231-03.....535	65226-25.....540	67177-11.....553/1	67207-18.....554
61810-70.....529	63231-04.....535	65226-28.....540	67178-12.....553/2	67207-19.....554
61810-90.....529	63231-05.....535	65227-22.....540	67178-14.....553/2	67207-20.....554
61820-05.....529	63231-06.....535	65227-25.....540	67179-14.....553/2	67207-21.....554
61820-10.....529	63232-01.....536	65227-28.....540	67184-39.....554	67207-22.....554
61820-15.....529	63232-02.....536	65230-21.....541	67185-35.....554	67207-23.....554
61820-20.....529	65102-12.....537	65230-23.....541	67201-08.....554	67207-24.....554
61820-25.....529	65102-14.....537	65230-25.....541	67201-10.....554	67207-25.....554
61820-30.....529	65108-15.....537	65231-21.....541	67201-12.....554	67207-26.....554
61820-35.....529	65110-15.....537	65231-23.....541	67201-14.....554	67207-27.....554
61820-40.....529	65120-15.....537	65231-25.....541	67201-16.....554	67207-28.....554
61820-45.....529	65120-19.....537	65236-25.....541	67201-18.....554	67207-29.....554
61820-50.....529	65120-22.....537	65237-25.....541	67201-20.....554	67207-30.....554
61820-70.....529	65120-24.....537	65238-33.....541	67201-22.....554	67211-06.....555
61820-90.....529	65124-16.....537	65239-33.....541	67201-24.....554	67211-08.....555
61910-01.....530	65124-20.....537	65241-23.....542	67201-26.....554	67211-10.....555
61910-02.....530	65124-22.....537	65242-30.....542	67201-28.....554	67211-12.....555
61910-03.....530	65124-25.....537	65255-19.....543	67201-30.....554	67211-14.....555
61910-04.....530	65124-30.....537	65256-19.....543	67201-32.....554	67211-16.....555
61920-14.....530/1	65130-15.....537	65259-24.....543	67201-34.....554	67211-18.....555
61920-23.....530/1	65132-16.....538	65260-24.....543	67201-36.....554	67211-20.....555
61930-18.....530/1	65132-20.....538	65261-15.....544	67205-08.....554	67211-22.....555
61930-21.....530/1	65140-15.....538	65262-12.....544	67205-10.....554	67211-24.....555
63101-23.....530/2	65140-19.....538	65263-15.....544	67205-12.....554	67213-06.....555
63103-23.....530/2	65145-15.....538	65263-20.....544	67205-14.....554	67213-08.....555
63106-20.....530/2	65150-20.....538	65265-26.....545	67205-16.....554	67213-10.....555
63107-20.....530/2	65154-18.....538	65265-28.....545	67205-18.....554	67213-12.....555
63110-20.....530/2	65155-18.....538	65270-15.....545	67205-20.....554	67213-14.....555
63111-20.....530/2	65155-20.....538	65272-07.....545	67205-22.....554	67213-16.....555
63117-22.....530/2	65160-14.....539	65272-10.....545	67205-24.....554	67213-18.....555
63125-28.....531	65160-16.....539	65274-00.....545	67205-26.....554	67213-20.....555
63130-13.....531	65160-18.....539	65280-05.....546	67205-28.....554	67213-22.....555
63130-18.....531	65160-20.....539	65280-07.....546	67205-30.....554	67213-24.....555
63130-21.....531	65160-24.....539	65280-10.....546	67205-32.....554	67219-08.....555
63142-34.....531	65164-16.....539	65282-26.....546	67205-34.....554	67219-10.....555
63150-00.....532	65164-20.....539	65284-08.....546	67205-36.....554	67219-12.....555
63150-01.....532	65168-16.....539	65284-23.....546	67205-38.....554	67219-14.....555
63150-02.....532	65168-20.....539	65290-30.....547	67205-40.....554	67219-16.....555
63150-03.....532	65170-18.....539	65291-30.....547	67206-08.....554	67219-18.....555
63150-04.....532	65170-20.....539	65310-15.....548	67206-09.....554	67219-20.....555
63150-05.....532	65172-20.....539	65310-21.....548	67206-10.....554	67219-22.....555
63150-06.....532	65172-23.....539	65310-29.....548	67206-11.....554	67219-24.....555
63150-07.....532	65174-20.....539	65310-35.....548	67206-12.....554	67220-00.....555
63150-08.....532	65178-19.....539	65320-00.....549	67206-13.....554	67220-12.....555
63150-09.....532	65178-23.....539	67101-21.....550	67206-14.....554	67220-14.....555
63150-10.....532	65180-16.....539	67103-22.....550	67206-15.....554	67220-16.....555
63150-11.....532	65210-18.....540	67105-21.....550	67206-16.....554	67220-18.....555
63150-12.....532	65210-21.....540	67105-22.....550	67206-17.....554	67220-20.....555
63150-13.....532	65210-23.....540	67106-20.....550	67206-18.....554	67220-22.....555
63170-21.....533	65211-18.....540	67110-23.....550	67206-19.....554	67220-24.....555
63170-22.....533	65211-21.....540	67111-23.....550	67206-20.....554	67220-26.....555



67220-28.....555	69302-42.....566	71241-02.....572	71362-24.....577	71424-08.....579
67220-30.....555	69303-28.....566	71241-03.....572	71363-24.....577	71424-13.....579
67220-32.....555	69303-35.....566	71241-10.....572	71364-24.....577	71425-08.....579
67220-34.....555	69303-42.....566	71242-00.....572	71365-24.....577	71426-08.....579
67220-36.....555	69304-28.....566	71242-01.....572	71404-14.....578	71426-13.....579
67220-38.....555	69304-35.....566	71242-02.....572	71404-26.....578	71430-10.....580
67240-08.....556	69304-42.....566	71242-03.....572	71405-14.....578	71430-12.....580
67240-11.....556	69311-23.....567	71242-10.....572	71406-14.....578	71430-14.....580
67240-13.....556	69311-33.....567	71260-01.....573	71406-26.....578	71430-16.....580
67240-16.....556	69311-40.....567	71260-02.....573	71410-01.....578	71430-18.....580
67240-21.....556	69321-23.....567	71261-01.....573	71410-02.....578	71430-20.....580
67240-26.....556	69321-33.....567	71261-02.....573	71410-03.....578	71436-06.....580
67240-32.....556	69321-40.....567	71262-01.....573	71410-04.....578	71438-00.....580
67250-07.....556	69402-21.....567	71262-02.....573	71410-05.....578	71438-13.....580
67251-07.....556	69402-25.....567	71271-01.....573	71410-06.....578	71438-17.....580
69105-22.....559	69450-18.....568	71271-02.....573	71410-07.....578	71438-21.....580
69110-15.....559	69455-00.....568	71271-03.....573	71410-08.....578	71438-25.....580
69115-15.....559	69456-00.....568	71281-01.....573	71410-09.....578	71438-29.....580
69121-00.....559	69457-12.....568	71281-02.....573	71410-10.....578	71438-33.....580
69125-17.....559	69457-31.....568	71281-03.....573	71410-11.....578	71438-37.....580
69126-01.....560	69458-00.....568	71291-00.....573	71410-12.....578	71438-41.....580
69126-02.....560	69458-10.....568	71291-01.....573	71410-13.....578	71441-34.....581
69126-03.....560	69458-11.....568	71291-02.....573	71410-14.....578	71443-29.....581
69127-01.....560	69458-16.....568	71291-03.....573	71410-15.....578	71445-29.....581
69127-02.....560	69460-00.....568	71300-01.....574	71410-16.....578	71500-18.....582
69127-03.....560	71100-00.....569	71301-01.....574	71410-17.....578	71502-25.....582
69130-19.....560	71110-01.....570	71301-02.....574	71410-18.....578	71503-25.....582
69142-06.....560	71110-02.....570	71301-03.....574	71410-19.....578	71504-25.....582
69142-08.....560	71110-03.....570	71303-01.....574	71410-20.....578	71505-24.....582
69142-12.....560	71115-02.....569	71303-02.....574	71410-21.....578	71507-28.....582
69147-00.....561	71115-03.....569	71303-03.....574	71410-22.....578	71508-17.....582
69147-01.....561	71116-02.....570	71303-04.....574	71410-23.....578	71510-18.....582
69147-02.....561	71120-00.....570	71303-05.....574	71410-24.....578	71512-20.....583
69147-03.....561	71120-01.....570	71305-01.....574	71410-25.....578	71512-28.....583
69147-04.....561	71120-02.....570	71305-02.....574	71410-26.....578	71514-24.....583
69148-00.....561	71120-03.....570	71305-03.....574	71410-27.....578	71515-24.....583
69150-15.....561	71130-01.....570	71305-04.....574	71410-28.....578	71524-06.....583
69210-22.....562	71130-02.....570	71305-05.....574	71410-29.....578	71524-08.....583
69212-16.....562	71130-03.....570	71306-00.....575	71410-30.....578	71524-10.....583
69212-19.....562	71132-00.....570	71306-01.....575	71415-01.....578	71525-06.....583
69212-22.....562	71140-01.....570	71306-02.....575	71415-02.....578	71525-08.....583
69220-05.....562	71140-02.....570	71306-03.....575	71415-03.....578	71525-10.....583
69220-10.....562	71140-03.....570	71306-04.....575	71415-04.....578	71531-23.....583
69220-14.....562	71142-04.....570	71306-05.....575	71415-05.....578	71532-21.....583
69220-20.....562	71150-01.....571	71306-06.....575	71415-06.....578	71533-21.....583
69224-21.....563	71150-02.....571	71306-07.....575	71415-07.....578	71536-21.....584
69224-27.....563	71150-03.....571	71306-08.....575	71415-08.....578	71536-28.....584
69225-22.....563	71160-01.....571	71307-00.....576	71415-09.....578	71537-27.....584
69225-30.....563	71160-02.....571	71308-00.....576	71415-10.....578	71539-26.....584
69226-25.....564	71160-03.....571	71308-01.....576	71415-11.....578	71540-27.....585
69226-29.....564	71161-17.....571	71308-02.....576	71415-12.....578	71542-20.....585
69226-38.....564	71161-25.....571	71308-03.....576	71415-13.....578	71543-32.....585
69227-01.....565	71170-01.....571	71308-04.....576	71415-14.....578	71545-27.....585
69227-02.....565	71170-02.....571	71309-00.....576	71415-15.....578	71547-23.....585
69227-03.....565	71170-03.....571	71310-20.....577	71415-16.....578	71549-25.....585
69227-04.....565	71210-01.....572	71310-25.....577	71415-17.....578	71559-26.....586
69227-05.....565	71210-02.....572	71310-30.....577	71415-18.....578	71565-28.....586
69227-06.....565	71210-03.....572	71310-35.....577	71415-19.....578	71567-26.....586
69228-01.....565	71211-01.....572	71310-40.....577	71420-01.....579	71580-32.....586
69229-01.....565	71211-02.....572	71313-20.....577	71420-03.....579	71581-32.....586
69229-02.....565	71211-03.....572	71313-25.....577	71420-05.....579	71582-32.....586
69251-01.....563	71212-01.....572	71313-30.....577	71420-07.....579	71583-32.....586
69251-02.....563	71212-02.....572	71313-35.....577	71420-09.....579	71584-28.....586
69251-03.....563	71212-03.....572	71313-40.....577	71420-11.....579	71585-25.....586
69261-41.....566	71240-00.....572	71315-40.....577	71420-13.....579	71590-04.....587
69263-30.....566	71240-01.....572	71319-28.....577	71420-15.....579	71592-01.....587
69301-28.....566	71240-02.....572	71319-38.....577	71420-17.....579	71592-02.....587
69301-35.....566	71240-03.....572	71351-10.....477/577	71420-19.....579	71592-03.....587
69301-42.....566	71240-10.....572	71351-15.....477/577	71420-21.....579	71592-04.....587
69302-28.....566	71241-00.....572	71360-24.....577	71420-23.....579	71593-00.....587
69302-35.....566	71241-01.....572	71361-24.....577	71420-25.....579	71594-40.....587

71596-40.....587	71703-02.....595	71725-16.....597	73147-36.....603/2	75379-10.....610
71598-27.....587	71703-03.....595	71725-19.....597	73148-17.....603/2	75382-16.....610
71604-01.....588	71703-04.....595	71725-20.....597	73151-29.....604	75396-01.....611
71604-02.....588	71703-05.....595	71727-05.....597	73155-44.....604	75396-02.....611
71604-21.....588	71703-06.....595	71727-06.....597	73157-40.....604	75397-00.....611
71604-28.....588	71704-27.....595	71727-07.....597	73162-40.....604	75400-01.....612
71605-26.....588	71710-05.....597	71727-08.....597	73170-00.....604	75400-02.....612
71606-24.....588	71710-06.....597	71727-09.....597	73171-21.....604	75400-03.....612
71611-25.....588	71710-07.....597	71727-11.....597	73181-33.....605	75400-04.....612
71612-21.....588	71710-08.....597	71727-12.....597	73183-27.....605	75410-01.....612
71613-28.....589	71710-09.....597	71727-14.....597	73184-21.....605	75410-02.....612
71615-01.....589	71710-11.....597	71727-15.....597	73187-09.....605	75410-03.....612
71615-02.....589	71710-12.....597	71727-16.....597	73189-09.....605	75410-04.....612
71617-04.....589	71710-14.....597	71727-19.....597	73191-34.....605	75410-15.....612/1
71618-23.....589	71712-05.....597	71727-20.....597	73193-30.....605	75420-15.....612/1
71619-23.....589	71712-06.....597	71730-30.....597	73195-35.....605	75430-01.....612/1
71621-01.....590	71712-07.....597	71730-35.....597	73242-27.....606	75430-12.....612
71621-01-25.....590	71712-08.....597	71730-40.....597	73243-27.....606	75430-13.....612
71622-00.....590	71712-09.....597	71732-30.....597	73244-01.....606	75440-00.....612
71622-00-25.....590	71712-11.....597	71732-35.....597	73244-02.....606	75440-11.....612/1
71623-00.....590	71712-12.....597	71732-40.....597	73244-03.....606	75445-12.....612/1
71623-00-25.....590	71712-14.....597	71735-30.....597	73245-01.....606	75450-00.....612
71624-01.....591	71715-05.....597	71735-35.....597	73245-02.....606	75450-13.....612/2
71624-03.....591	71715-06.....597	71735-40.....597	73245-03.....606	75460-13.....612/2
71624-04.....591	71715-07.....597	71736-00.....599	73252-30.....606	75470-11.....612/2
71624-05.....591	71715-08.....597	71736-07.....599	73254-14.....606	75475-11.....612/2
71624-06.....591	71715-09.....597	71736-08.....599	73254-18.....606	75480-13.....612/2
71624-07.....591	71715-11.....597	71736-09.....599	73254-21.....606	75485-13.....612/2
71624-08.....591	71715-12.....597	71736-10.....599	73256-42.....607	75490-15.....612/2
71624-09.....591	71715-14.....597	71736-11.....599	73259-28.....607	75500-15.....612/2
71624-10.....591	71717-05.....597	71736-12.....599	73302-42.....607	75550-13.....613
71624-11.....591	71717-06.....597	71737-06.....599	73304-46.....607	75600-10.....613
71624-13.....591	71717-07.....597	71737-08.....599	73306-25.....607	75618-15.....613
71624-14.....591	71717-08.....597	71737-10.....599	73309-30.....607	75620-15.....613
71624-15.....591	71717-09.....597	71737-12.....599	75103-15.....608	75630-12.....614
71624-16.....591	71717-11.....597	71737-14.....599	75111-10.....608	75640-15.....614
71624-17.....591	71717-12.....597	71737-30.....597	75113-14.....608	89111-25.....615
71624-18.....591	71717-14.....597	71737-35.....597	75115-14.....608	89111-32.....615
71624-19.....591	71720-05.....597	71737-40.....597	75118-14.....608	89112-65.....615
71626-00.....592	71720-06.....597	71803-03.....600	75121-10.....608	89113-65.....615
71626-00-25.....592	71720-07.....597	71803-04.....600	75128-01.....608	89114-00.....615
71627-00.....592	71720-08.....597	71803-06.....600	75128-02.....608	89115-50.....615
71628-00.....592	71720-09.....597	71803-08.....600	75128-03.....608	89115-65.....615
71628-00-25.....592	71720-11.....597	71803-10.....600	75128-04.....608	89115-75.....615
71630-00.....590	71720-12.....597	71803-12.....600	75128-05.....608	89116-50.....615
71632-00.....593	71720-14.....597	71803-14.....600	75128-06.....608	89116-65.....615
71634-00.....593	71720-15.....597	71803-15.....600	75129-01.....608	89116-75.....615
71635-26.....593	71720-16.....597	71810-12.....601	75129-02.....608	89121-40.....617
71641-17.....594	71720-19.....597	71810-16.....601	75129-03.....608	89121-50.....617
71643-27.....594	71720-20.....597	71810-20.....601	75129-04.....608	89122-16.....617
71645-01.....594	71722-05.....597	71810-50.....601	75129-05.....608	89122-21.....617
71645-02.....594	71722-06.....597	73101-23.....602	75129-06.....608	89122-26.....617
71645-03.....594	71722-07.....597	73102-30.....602	75130-01.....608	89122-30.....617
71646-01.....594	71722-08.....597	73105-33.....602	75130-02.....608	89124-23.....618
71646-02.....594	71722-09.....597	73105-36.....602	75130-03.....608	89124-26.....618
71650-00.....596	71722-11.....597	73107-30.....602	75138-00.....608	89124-27.....618
71650-01.....596	71722-12.....597	73108-36.....602	75140-02.....608	89124-30.....618
71650-02.....596	71722-14.....597	73108-39.....602	75140-03.....608	89124-32.....618
71650-03.....596	71722-15.....597	73110-41.....602	75140-04.....608	89124-42.....618
71650-04.....596	71722-16.....597	73115-32.....603	75140-05.....608	89125-23.....618
71650-05.....596	71722-19.....597	73115-38.....603	75140-06.....608	89125-26.....618
71650-06.....596	71722-20.....597	73119-36.....603	75140-07.....608	89125-30.....618
71650-07.....596	71725-05.....597	73119-40.....603	75140-08.....608	89125-32.....618
71660-00.....596	71725-06.....597	73123-39.....603	75301-10.....609	89125-42.....618
71702-01.....594	71725-07.....597	73125-40.....603	75304-10.....609	89126-23.....618
71702-02.....594	71725-08.....597	73127-40.....603	75305-10.....609	89126-26.....618
71702-03.....594	71725-09.....597	73135-36.....603	75331-14.....609	89126-27.....618
71702-04.....594	71725-11.....597	73139-40.....603/1	75341-11.....609	89126-30.....618
71702-05.....594	71725-12.....597	73141-39.....603/1	75341-13.....609	89126-32.....618
71702-06.....594	71725-14.....597	73143-39.....603/1	75373-10.....610	89126-42.....618
71703-01.....595	71725-15.....597	73145-36.....603/1	75378-10.....610	89127-04.....619

89127-06.....619	89155-13.....622	91010-03.....628	91801-21.....634
89127-08.....619	89155-15.....622	91010-11.....628	91801-25.....634
89127-11.....619	89155-19.....622	91010-12.....628	98000-01.....635
89127-12.....619	89159-14.....622	91010-13.....628	98000-02.....635
89127-14.....619	89159-16.....622	91010-14.....628	R190.03.....622
89127-16.....619	89159-19.....622	91010-15.....628	R190.05.....622
89127-18.....619	89159-24.....622	91010-16.....628	R190.07.....622
89127-23.....618	89164-14.....622	91010-17.....628	R190.10.....622
89127-26.....618	89164-16.....622	91010-18.....628	R191.03.....622
89127-30.....618	89164-19.....622	91010-21.....628	R191.05.....622
89127-32.....618	89164-24.....622	91010-31.....628	R191.07.....622
89127-42.....618	89164-29.....622	91010-33.....628	R191.10.....622
89129-11.....619	89164-34.....622	91010-34.....628	R390.03.....622
89133-16.....619	89164-39.....622	91010-35.....628	R390.05.....622
89133-17.....619	89169-14.....622	91010-36.....628	R390.07.....622
89133-22.....619	89169-16.....622	91011-51.....629	R390.10.....622
89133-24.....619	89169-19.....622	91011-52.....629	
89133-31.....619	89169-24.....622	91011-53.....629	
89133-34.....619	89169-29.....622	91011-54.....629	
89133-38.....619	89169-34.....622	91011-55.....629	
89139-17.....619	89169-39.....622	91011-56.....629	
89139-25.....619	89174-14.....622	91011-61.....629	
89139-27.....619	89174-16.....622	91011-62.....629	
89140-02.....620	89174-19.....622	91020-01.....629	
89140-05.....620	89174-24.....622	91020-02.....629	
89140-10.....620	89174-29.....622	91020-03.....629	
89140-20.....620	89174-34.....622	91020-04.....629	
89141-10.....620	89174-39.....622	91022-05.....629	
89142-01.....620	89179-14.....622	91022-10.....629	
89142-02.....620	89179-16.....622	91022-20.....629	
89142-03.....620	89179-19.....622	91024-10.....629	
89142-04.....620	89179-24.....622	91024-15.....629	
89142-05.....620	89179-29.....622	91024-20.....629	
89142-06.....620	89179-34.....622	91030-02.....629	
89142-07.....620	89179-39.....622	91030-04.....629	
89143-00.....621	89179-49.....622	91030-06.....629	
89143-01.....621	89179-59.....622	91102-11.....630	
89143-02.....621	89250-10.....623	91104-11.....630	
89143-03.....621	89250-20.....623	91109-11.....630	
89143-04.....621	89250-30.....623	91113-11.....630	
89143-05.....621	89250-40.....623	91115-11.....630	
89143-06.....621	89250-50.....623	91122-16.....630	
89143-07.....621	89250-60.....623	91123-16.....630	
89143-08.....621	89256-29.....623	91124-16.....630	
89143-09.....621	89256-46.....623	91125-16.....630	
89143-10.....621	89256-67.....623	91127-16.....630	
89145-23.....620	89257-46.....623	91142-16.....631	
89145-30.....620	89260-13.....624	91144-16.....631	
89145-31.....620	89260-17.....624	91146-16.....631	
89145-35.....620	89260-20.....624	91152-19.....631	
89146-20.....268/621	89260-25.....624	91154-19.....631	
89147-10.....621	89260-30.....624	91157-19.....631	
89147-21.....620	89260-40.....624	91159-19.....631	
89147-24.....620	89265-12.....624	91162-19.....632	
89147-25.....621	89270-15.....624	91164-19.....632	
89147-30.....620	89500-00.....626	91166-19.....632	
89147-31.....620	89500-01.....626	91167-19.....632	
89147-35.....620	89500-02.....626	91169-19.....632	
89147-40.....620	89500-03.....626	91172-03.....632	
89147-42.....620	89500-04.....626	91172-07.....632	
89148-25.....621	89500-05.....626	91172-12.....632	
89148-31.....621/1	89500-06.....626	91190-30.....633	
89148-32.....621/1	89500-07.....626	91190-50.....633	
89148-35.....621/1	89500-08.....626	91192-30.....633	
89148-50.....621	89500-09.....626	91192-50.....633	
89150-30.....621/1	89500-10.....626	91193-30.....633	
89152-08.....622	89500-11.....626	91193-50.....633	
89152-10.....622	89500-12.....626	91800-18.....634	
89152-12.....622	89501-03.....626	91800-21.....634	
89155-08.....622	91010-01.....628	91800-25.....634	
89155-10.....622	91010-02.....628	91801-18.....634	

Absfallzange, SAUERBRUCH .....	227	anatomische Pinzette, CUSHING-TAYLOR .....	87	Arterienklemme, KELLY-RANKIN .....	106
Abortuskürette, PESTALOZZA .....	606	anatomische Pinzette, DUEHRSEN .....	84	Arterienklemme, KOCHER .....	108
Abortuslöffel, CUZZI .....	606	anatomische Pinzette, GERALD .....	86, 87	Arterienklemme, LAHEY .....	119/2
Abortuslöffel, WALLICH .....	607	anatomische Pinzette, McINDOE .....	85	Arterienklemme, LAWRENCE .....	119
Abortuszange, SAENGER .....	606	anatomische Pinzette, OCHSNER .....	88	Arterienklemme, LERICHE .....	111
Abortuszange, WINTER .....	606	anatomische Pinzette, POTTS-SMITH .....	81	Arterienklemme, LOVELACE .....	109
ABRAHAM, Tonsillenfasszange .....	468	anatomische Pinzette, SEMKEN .....	86	Arterienklemme, LOWER .....	120
ABRAHAM, Tonsillennmesser .....	466	anatomische Pinzette, STILLE .....	81	Arterienklemme, MAYO-GUYON .....	122
Absauganlage f. Gipssäge .....	231	anatomische Pinzette, TAYLOR .....	87	Arterienklemme, MEEKER .....	119
Absaugküretten .....	600	anatomische Pinzette, TC .....	81	Arterienklemme, Micro-HARTMANN .....	104
Absaugrohr, BUIE .....	566	anatomische Pinzette, USA .....	81	Arterienklemme, MIXTER .....	116, 119/1
Absaugrohr, KLEINSASSER .....	36	anatomische Pinzette, WANGENSTEEN .....	89	Arterienklemme, MIXTER-BABY .....	119/1
ADAIR, Hakenzange .....	582	ANDERSON, Wundhaken .....	198	Arterienklemme, MOYNIHAN .....	120
ADLERKREUTZ, Gefäßspinzette .....	84	ANDREW, Zungendrücker .....	452	Arterienklemme, O'SHAUGNESSY .....	119/2
ADSON, anatomische Pinzette .....	81/2	ANDREW-PYNCHON, Saugrohr .....	28	Arterienklemme, OVERHOLT .....	114
ADSON, Arterienklemme .....	112	Anestrophon .....	23	Arterienklemme, OVERHOLT-BABY .....	114
ADSON, chirurgische Pinzette .....	81/2	Aneurysmklemme, DeBAKEY-BAHNSON .....	506	Arterienklemme, OVERHOLT-GEISSENDOERFER .....	114
ADSON, Durahaken .....	329	Anlegepinzette, MEHDORN .....	362	Arterienklemme, OVERHOLT-MIXTER .....	115
ADSON, Halteklemme .....	298	Anlegezange .....	357 - 360	Arterienklemme, PEAN .....	108, 110
ADSON, Hohlmeißelzange .....	236	Anlegezange, JOHNS-HOPKINS .....	104	Arterienklemme, PENNINGTON .....	109
ADSON, Hypophysepinzette .....	334	Anlegezange, MCKENZIE .....	326	Arterienklemme, PROVIDENCE-HOSPITAL .....	106
ADSON, Nadelhalter .....	211	Anlegezange, OLIVECRONA-TOENNIS .....	326	Arterienklemme, ROBERTS .....	117
ADSON, Raspator .....	282	Anlegezange, RANEY .....	327	Arterienklemme, ROCHESTER-CARMALT .....	109
ADSON, Saugrohr .....	337	Anlegezange, SMITHWICK .....	326	Arterienklemme, ROCHESTER-OCHSNER .....	108
ADSON, Wundspreizer .....	172-174	Anlegezange, SWEET .....	326	Arterienklemme, ROCHESTER-PEAN .....	108
ADSON-BABY, Arterienklemme .....	113	ANTRUM, Kürette .....	435	Arterienklemme, RUMEL .....	117
ADSON-BABY, Wundspreizer .....	173	Antrumkürette, COAKLEY .....	449	Arterienklemme, SAROT .....	118
ADSON-BROWN, chirurgische Pinzette .....	82	Antrumraspel, GALLAHER .....	446	Arterienklemme, SPENCER-WELLS .....	109
ADSON-Micro, anatomische Pinzette .....	81/2	Antrumraspel, WIENER .....	443	Arterienklemme, STILLE .....	122
ADSON-Micro, chirurgische Pinzette .....	82	Anuskop, HIRSCHMANN .....	562	Arterienklemme, TOENNIS .....	117
AEBLI, Ophthalmologie-Schere .....	58	Anuskop, IVES-FANSLER .....	562	Arterienklemme, WIKSTROEM .....	117
Ahle, OBWEGESER .....	463, 463/3	Anuskop, KELLY .....	562, 563	Arterienklemme, ZENKER .....	118
AIR-INJECTION, Augenkantüle .....	394	ANVIL, Nagelspaltzange .....	613	ASCH, Septumrichtzange .....	449
ALAN-PARKS, Mastdarm-Spekula .....	561	Aorta-Aneurysmklemme, DeBAKEY .....	496 - 498	Atrauma-Arterienklemme .....	492 - 527
ALDERDYCE, Elevator .....	282	Aortahaken, ROSS .....	148/1	Atrauma-Arterienklemme, DeBAKEY-MOSQUITO .....	509
ALEXANDER, Biopsiezange .....	589	Aortaklemme, DeBAKEY .....	499, 500	Atrauma-Arterienklemme, DeBAKEY-PEAN .....	513
ALEXANDER, Flachmeißel .....	259	Aortaklemme, DIETRICH .....	510	Atrauma-Arterienklemme, DeBAKEY-RANKIN .....	512
ALEXANDER, Hohlmeißel .....	259	Aortaklemme, MORRIS-DeBAKEY .....	506	Atrauma-Bulldogklemme, DeBAKEY .....	103
ALEXANDER, Raspator .....	276	Aortaklemme, WEBER .....	501	Atrauma-Bulldogklemme, GLOVER .....	103
ALEXANDER, Uterus-Biopsiezange .....	589	Aortaklemme, WYLIE .....	501/1	Atrauma-Darmfaßzange .....	539
ALLEN, Blinddarmklemme .....	544	Aortastanze .....	528	Atrauma-Neonataalklemme .....	523
ALLIS, Darmfasszange .....	537	Approximator, BIEMER .....	366	Atrauma-Pinzette, DeBAKEY .....	98
ALLIS-ADAIR, Darmfasszange .....	537	Approximator, BIEMER-MÜLLER .....	363	Atrauma-Pinzette, DeBAKEY TC .....	99
ALLIS-BABY, Darmfasszange .....	537	Approximator, MÜLLER .....	364	Atrauma-Gefäßklemme, BECK .....	516
ALLISON, Lungenspatel .....	489/2	ARCHER, Splitterzange .....	92	AUFFRANC-COBRA, Knochenheber .....	289
ALM, Wundhaken .....	168	ARL, Starschlinge .....	378	AUFFRANC-COBRA, Wundhaken .....	289
ALU, Stimmgabeln .....	403	Armsystem .....	188, 189	Aufreiber, KUNTSCHER .....	321
ALVIS, Fremdkörperkürette .....	374	ARRUGA, Extraktionshaken .....	375	AUFRICHT, Nasenhaken .....	447
Amnioskop .....	601	ARRUGA, Kapselpinzette .....	391	AUFRICHT, Nasenraspel .....	443
Amniotom, BEACHAM .....	586	ARRUGA, Lidsperrer .....	370	Aufsatz, BARACANI .....	472
Amputationsmesser, CATLIN .....	44	ARRUGA, Nadelhalter .....	214	Aufsatz, BRUENINGS .....	472
Amputationsmesser, LANGENBECK .....	44	ARRUGA, Wundlöffel .....	378	Aufsatz, CORDES .....	472
Amputationsmesser, LISTON .....	44	Arterienklemme, ADSON .....	112	Aufsatz, FRAENKEL .....	472
Amputationsmesser, REDA .....	44	Arterienklemme, ADSON-BABY .....	113	Aufsatz, KRAUSE .....	472
Amputationssäge, BIER .....	296	Arterienklemme, BAINBRIDGE .....	119/2	Aufsatz, LANGE .....	472
Amputationssäge, CHARRIERE .....	296	Arterienklemme, BENGOLEA .....	112	Aufsatz, Reinigungspistole .....	626
Amputationssäge, SATTERLEE .....	296	Arterienklemme, BIRKETT .....	116	Aufsatz, SCHEINMANN .....	472
Anal spreizer, SMITH-BUIE .....	561	Arterienklemme, CRAFOORD-SELLORS .....	119	Aufsatz, SCHUMACHER .....	472
Anastomosenklemme, BECK .....	516, 520	Arterienklemme, CRILE .....	107	Aufsatz, SEIFERT .....	472
Anastomosenklemme, COOLEY .....	520/1, 520/4	Arterienklemme, CRILE-RANKIN .....	107	Aufsatz, SLUDER-BALLENGER .....	470
Anastomosenklemme, COOLEY-DERRA .....	519	Arterienklemme, DANDY .....	109	Aufsatz, Uterus-Biopsiezangen .....	591
Anastomosenklemme, DeBAKEY .....	505	Arterienklemme, DESJARDINS .....	121	Augenkantüle .....	394
Anastomosenklemme, DeMARTEL-WOLFSON .....	546	Arterienklemme, FUCHSIG .....	113	Augenkantüle, AIR-INJECTION .....	394
Anastomosenklemme, DERRA .....	515	Arterienklemme, GEMINI .....	115	Augenkantüle, JENSEN .....	394
Anastomosenklemme, LAMBERT-KAY .....	505	Arterienklemme, GRAY .....	121	Augenkantüle, LACRIMAL .....	394
Anastomosenklemme, POTTS .....	493	Arterienklemme, GUYON .....	122	Augenkantüle, McINTYRE .....	394
anatomische Pinzette .....	81, 86	Arterienklemme, HALSTED-MOSQUITO .....	105	Augenkantüle, SHEETS .....	394/2
anatomische Pinzette, ADSON .....	81/2	Arterienklemme, HARTMANN .....	104	Augenmagnet, REDA .....	395
anatomische Pinzette, ADSON-DeBAKEY .....	81/2	Arterienklemme, HEISS .....	112	Augenpinzetten .....	382 - 393
anatomische Pinzette, ADSON-Micro .....	81/2	Arterienklemme, JACOBSON .....	105	Augenschere, BARRAQUER .....	75
anatomische Pinzette, BONNEY .....	88	Arterienklemme, JOHNS-HOPKINS .....	120	Augenschere, NOYES .....	75
anatomische Pinzette, BROPHY .....	84	Arterienklemme, KANTROWITZ .....	119/1	Augenschere, VANNAS .....	79
anatomische Pinzette, CUSHING .....	83	Arterienklemme, KELLY .....	106	Augenschere, WECKER .....	75

Augenschere, WESTCOTT .....	75	Bauchdeckenhalter, DENIS-BROWNE .....	185	Biopsiezange, KEVORKIAN .....	589, 591
Aurikelklemme, HARKEN .....	503	Bauchdeckenhalter, DOYEN .....	189/1	Biopsiezange, KEVORKIAN-PACIFIC .....	592
Autopsiesäge .....	230, 230/2	Bauchdeckenhalter, FRAZIER .....	181	Biopsiezange, MAXI GRASPER .....	593
AUVARD, Scheidenspekula .....	576	Bauchdeckenhalter, GELPI .....	189/1, 189/2	Biopsiezange, MINI-TOWNSEND-DOWN .....	591
AXENFELD, Chalzazionskürlette .....	377	Bauchdeckenhalter, GOSSET .....	181	Biopsiezange, MINI-TOWNSEND-UP .....	591
AYER, Chalzazionspinzette .....	393	Bauchdeckenhalter, HORGAN .....	183	Biopsiezange, SCHUBERT .....	588
B		Bauchdeckenhalter, JACKSON-BURROWS .....	189/2	Biopsiezange, SCHUMACHER .....	588, 589
BABCOCK, Darmfasszange .....	539	Bauchdeckenhalter, KIRSCHNER .....	185 - 187/1	Biopsiezange, THOMAS-GAYLOR .....	588
BABINSKI, Perkussionshammer .....	24	Bauchdeckenhalter, O'SULLIVAN-O'CONNOR .....	181	Biopsiezange, TISCHLER-BABY .....	592
BABY-BURKE, Uterus-Biopsiezange .....	590	Bauchdeckenhalter, RICARD .....	191	Biopsiezange, TISCHLER-DOWN .....	591
BABY-GOSSET, Bauchdeckenhalter .....	181	Bauchdeckenhalter, RIGBY .....	189/2	Biopsiezange, TISCHLER-KEVORKIAN .....	592
BABY-KOCHER, Darmklemme .....	540	Bauchdeckenhalter, ROCHARD .....	186	Biopsiezange, TISCHLER-MORGAN .....	590, 591
BABY-METZENBAUM, Supercuttschere .....	71	Bauch- u. Darmspatel .....	143/2	Biopsiezange, TISCHLER-UP .....	591
BABY-OLSEN-HEGAR, Nadelhalter .....	212	Bauch- u. Darmspatel, KADER .....	143/1	Biopsiezange, TOWNSEND .....	591
BABYPHON, Blutdruckmessgerät .....	10	Bauch- u. Darmspatel, KÖRTE .....	143/1	Biopsiezange, VAN DOREN .....	588
BABY-TISCHLER, Uterus-Biopsiezange .....	592	Bauch- u. Darmspatel, KÜMMEL .....	143/4, 144	Biopsiezange, WITNER .....	589
BABY-WEBSTER, Nadelhalter .....	208	Bauch- u. Darmspatel, LERICHE .....	143/4	Bipolare Koagulation .....	630 - 633
BABY-YANKAUER, Saugrohr .....	27	BAUMGARTNER, Nadelhalter .....	208	Bipolarkabel .....	633
BACKHAUS, Tuchklemme .....	132	BEACHAM, Amniotom .....	586	Bipolare Pinzette .....	630 - 632
BACKHAUS-CLIP, Tuchklemme .....	132	BECHERT, Linsenmanipulator .....	379	BIRCHER-GANSKE, Knochenhaltezange .....	246
BACKHAUS-BABY, Rippenkontraktor .....	489/1	BECK, Anastomosenklemme .....	516, 520	BIRKETT, Arterienklemme .....	116
BAILEY-GIBBON, Rippenkontraktor .....	489/1	Beckenzirkel, COLLIER .....	605	BISHOP-HARMAN, Irispinzette .....	386
BAILEY, Rippenkontraktor .....	489/1	Beckenzirkel, COLLIN .....	605	BISHOP-HARMON, Spül- und Saugkanüle .....	394/1
BAINBRIDGE, Arterienklemme .....	119/2	Beckenzirkel, MARTIN .....	605	Blätter-Wechselpinzette .....	179
BAINBRIDGE, Mehrzweck-Gefässklemme .....	495/1, 495/2	BECKER, Cystotom .....	375	BLAKE, Gallensteinzange .....	530/2
BAKES, Gallengangdilator .....	532	BECKMANN, Ringmesser .....	450	BLAKE, Uteruskürlette .....	595
BALFOUR-BABY, Bauchdeckenhalter .....	182	BECKMANN, Wundspreizer .....	176	Blasenhalsperrer, MILLIN .....	553
BALFOUR, Bauchdeckenhalter .....	182	BECKMANN-ADSON, Wundspreizer .....	175	Blasenspatel, KOCHER .....	552
BALFOUR, Haken .....	193	BECKMANN-EATON, Wundspreizer .....	176	Blasenspatel, LEGUEU .....	552
BALFOUR-US, Bauchdeckenhalter .....	184	BEEBEE, Kronenschere .....	68	Blasenwundspreizer, JUDD-MASSON .....	552
BALFOUR, Valve f. Bauchdeckenhalter .....	183	BEER, Cilienpinzette .....	395	Blasenwundspreizer, LEGUEU .....	553
BALL AND SOCKET, Tuchklemme .....	133	BEESON, Gipsspreizer .....	232	Blasenwundspreizer, MILLIN .....	552
BALLENGER, Schwingmesser .....	436	Begrenzungsscheibe .....	230/17	Blasenwundspreizer, THOMSON-WALKER .....	552
BALLENGER, Septumellevator .....	439	Beinhautmesser .....	47	Blattosteotom, OBWEGESER .....	464/1
BALLENGER, Tonsillenzange .....	467	Beleuchtungsstab f. MORGAN .....	565	Bleihand .....	250
Bandmass .....	25	BELLUCCI, Mikro-Ohrscherchen .....	413, 417	Blinddarmklemme, ALLEN .....	544
Bandscheibenstanze, COLCLOUGH .....	344/1	BENDER, Einschläger .....	322/1	Blinddarmklemme, KLEINSCHMIDT .....	544
Bandscheibenstanze, FERRIS-SMITH-KERRISON .....	344, 344/2	BENGOLEA, Arterienklemme .....	112	BLOHMKE, Tonsillenzange .....	467
BANE-HARTMANN, Hohlmeisselzange .....	237	BENNETT, Knochenhebel .....	283	BLOUNT, Knochenhebel .....	288
BANGERTER, Zykliodialysespatel .....	379	BENSAUDE, Proktoskop .....	565	BLOUNT, Meniskushaken .....	289
BARACANI, Aufsatz .....	472	BENSON, Pylorusspreizer .....	544	BLUMENTHAL, Hohlmeisselzange .....	236
BARANY, Lämtrommel .....	405	BERENS, Diszisionsmesser .....	372	Blutdruckmessgerät, BABYPHON .....	10
BARBARA, Hähchen .....	419	BERGMANN, Hammer .....	272	Blutdruckmessgerät, DIPLOMAT .....	5
BARBARA, Nadel .....	419	BERGMANN, Verbandschere .....	69/1	Blutdruckmessgerät, EXACTA .....	8
BARKAN, Goniotomiemesser .....	373	BERKE, Muskelpinzette .....	389	Blutdruckmessgerät, PRECISA .....	9
BARNHILL, Ringmeser .....	450	BERLINER, Perkussionshammer .....	24	Blutschöpfföfjel .....	268
BARON, Saugrohr .....	336	BERNHARD, Tuchklemme .....	133	Blutstillungsmeißel, PASSOW .....	260
BARR, Mastdarmspekula .....	559	BERRY, Drahtzange .....	319	BÖHLER, Hohlmeisselzange .....	238
BARRAQUER, Augenschere .....	75	Beschheidungsgerät, MOGEN .....	556	BÖHLER, Knochensplitterzange .....	241
BARRAQUER, Cilienpinzette .....	395	Beschheidungsinstrument .....	556	BODENHAMMER, Mastdarmspekula .....	559
BARRAQUER, Fixationspinzette .....	390	BETHUNE, Rippenschere .....	481	BOEHLER, Extensionsbügel .....	312
BARRAQUER, Irispinzette .....	384	BEYER, Hohlmeisselzange .....	237	BOERMA, Geburtszange .....	604
BARRAQUER, Keratoplastik-Messer .....	373	Biegeeisen, BENDER .....	322	BOETTCHEr, Tonsillenschere .....	59
BARRAQUER, Lidsperrer .....	370	Biegehebel, LANE .....	325	Bohrapparat, STILLE-SHERMAN .....	298
BARRAQUER, Nadelhalter .....	216, 217	BIEMER, Approximator .....	366	Bohrdraht, KIRSCHNER .....	306, 307
BARRAQUER-KATZIN, Irispinzette .....	384	BIEMER, Gefässclip .....	361	Bohrdrahtspender .....	305, 310
BARRAQUER-TROUTMAN, Nadelhalter .....	216	BIEMER-MÜLLER, Approximator .....	363	Bohrdrahtstütze .....	299
BARRET, Hakenzange .....	582	BIER, Amputationssäge .....	296	Bohrer .....	298, 302
BARTON, Geburtszange .....	603/2	BILL, Zughebel .....	604	Bohrer, CRUTCHFIELD .....	327
BARTON, Zughebel .....	603/2	BILLEAU, Ohrschlinge .....	409	Bohrer, ERRICO .....	299
Batteriegriff, Kaltlicht .....	33	Biopsie- und Absaugkürlette .....	600	Bohrer, MCKENZIE .....	299
Batteriegriff, Warmlicht .....	32	Biopsiekanüle, MENGHINI .....	206	BOIES, Elevator .....	277
Bauch- u. Darmspatel .....	143/1 - 143/4	Biopsiekürlette .....	600	Bolzenschneider .....	320
Bauch- u. Darmspatel, KÜMMEL .....	143/4	Biopsiekürlette, HEANY .....	587	BONACCOLTO, Strabismuspinzette .....	385
Bauchdeckenhalter, BABY-GOSSET .....	181	Biopsiekürlette, KEVORKIAN .....	587	BONN, Irispinzette .....	387
Bauchdeckenhalter, BALFOUR .....	182	Biopsiekürlette, MOD. MÜNCHEN .....	587	BONNEY, Pinzette .....	88
Bauchdeckenhalter, BALFOUR-BABY .....	182	Biopsiekürlette, NOVAK .....	587	BOSE, Trachealhaken .....	477
Bauchdeckenhalter, BALFOUR-US .....	184	Biopsiekürlette, RANDALL .....	587	BOSE, Trachealspreizer .....	476
Bauchdeckenhalter, CHARNELY .....	289	Biopsiezange, ALEXANDER .....	589	BOUCHERON, Ohrspekula .....	399
Bauchdeckenhalter, COLLIN .....	190	Biopsiezange, BABY-TISCHLER .....	592	BOWMAN, Diszisionsnadel .....	374
Bauchdeckenhalter, COLLIN-LOKTITE .....	191	Biopsiezange, BURKE .....	590	BOWMAN, Lidsperrer .....	370
Bauchdeckenhalter, DeBAKEY .....	189/1	Biopsiezange, EPPENDORFER .....	590	BOWMAN, Tränenkanalsonde .....	381
		Biopsiezange, FAURE .....	588	BOYNTON, Nadelhalter .....	214



BOYS-ALLIS, Darmfaßzange .....	538	Carotis-Shuntklemme, JAVID .....	511	Cilienpinzette, BEER .....	395
BOZEMANN, Nadelhalter .....	211	CARPENTER, Tonsillenelevator .....	465	Cilienpinzette, DOUGLAS .....	395
BOZEMANN, Tamponzange .....	138	CARPENTER, Tonsillennmesser .....	465	Cilienpinzette, GRADLE .....	395
BOZEMANN-DOUGLAS, Tamponzange .....	138	Cartilageschere, MARTIN .....	65/1	Cilienpinzette, LITTAUER .....	395
BRAND, Sehnenfassinstrument .....	293	CASPAR, Laminektomiespreizer .....	179, 180	Cilienpinzette, REDA .....	395
BRAND, Sehnenschäler .....	294	CASPAR, Spreizer .....	197	CINELLI, Septummeißel .....	441
BRAUN, Dekapitationshaken .....	607	CASPAR, Stössel .....	258	Circumcisionsgerät .....	556
BRAUN, Hakenzange .....	582	CASPAR, Wundspreizer .....	179, 180	CITELLI, Knochenstanze .....	430
BRAUN, Kranioklast .....	607	CASTANEDA, Neonatal-Gefäßklemme .....	527	CLAR, Stirnlampe .....	22
BRAUN, Uterusdepressor .....	586	CASTROVIEJO, Disziionsmesser .....	372	CLARK, Lidsperrerr .....	370
BRAUN-STADLER, Episotomie-Schere .....	64	CASTROVIEJO, Fixierpinzette .....	390	CLAUS, Tonsillennadel .....	466
BREAST, Wundhaken .....	198	CASTROVIEJO, Hornhautschere .....	79	CLAUS-EICKEN, Tonsillennadel .....	466
BREISKY, Scheidenspekula .....	577	CASTROVIEJO, Kapselpinzette .....	391	CLAYMAN, Hähchen .....	376
Breiten-Messinstrument .....	594	CASTROVIEJO, Klängenbrecher .....	45	CLEVELAND, Hohlmeißelzange .....	235
BRISTOW, Knochenhebel .....	290	CASTROVIEJO, Lidsperrerr .....	371	Clipanlegezange, ETHICON .....	524, 525
BRODIE, Hohlsonde .....	199	CASTROVIEJO, Messzirkel .....	380	Clipanlegezange, HORIZON .....	524, 525
Bronchoskopiezange, CHEVALIER-JACKSON .....	473	CASTROVIEJO, Nadelhalter .....	215, 216	Clipanlegezange, PILLING .....	524, 525
Bronchusklemme .....	126	CASTROVIEJO, Nahtpinzette .....	392	Clipanlegezange, SLS Clips .....	524, 525
Bronchusklemme, FINOCCHIETTO .....	490	CASTROVIEJO, Tränenkanal dilatator .....	381	CLOWARD, Laminektomiezange .....	342
Bronchusklemme, HARRINGTON .....	490	CASTROVIEJO, Zyklo dialysespatel .....	379	CLOWARD, Wirbelkörperspreizer .....	339
Bronchusklemme, LEES .....	504	CASTROVIEJO-Micro, Nadelhalter .....	215	CLOWARD, Wundsperrerr .....	178/1 - 178/4
Bronchusklemme, PRICE-THOMAS .....	490	CASTROVIEJO-STANDARD, Nadelhalter .....	216	COAKLEY, Antrumkürette .....	449
Bronchusklemme, SEMB .....	491	CATLIN, Amputationsmesser .....	44	COAKLEY, Kieferhöhlenotrokar .....	204
BROPHY, Pinzette .....	84	Cauter, WADSWORTH-TODD .....	378	Coarctationsklemme, DeBAKEY .....	507
BROWN, Gewebepinzette .....	83	CAWOOD-MINNESOTA, Wangenhalter .....	451	Coarctationsklemme, POTTS .....	492
BROWN, Nadelhalter .....	209	Cervicalspreizer, CLOWARD .....	178/1 - 179	COBB, Hohlmeißel .....	262
BRUENINGS, Aufsatz .....	472	Chalazionskürette, AXENFELD .....	377	COBB, Kürette .....	252
BRUENINGS, Ohrspekula .....	401	Chalazionskürette, HEBRA .....	377	COBB, Raspator .....	280
BRUENINGS, Septumzange .....	425	Chalazionskürette, MEYHOEFER .....	377	COBB, scharfer Löffel .....	252
BRUENINGS, Tonsillennmesser .....	466	Chalazionspinzette, AYER .....	393	COLCLOUGH, Bandscheibenstanze .....	344/1
BRUENINGS, Tonsillenschürer .....	468	Chalazionspinzette, DESMARRÉS .....	393	COLLER-CRILE, Arterienklemme .....	106
BRUENINGS, Verlängerungsrohr .....	472	Chalazionspinzette, LAMBERT .....	393	COLLIER, Beckenzirkel .....	605
BRUENINGS, Zungenspatel .....	451	CHANDLER, Elevator .....	282	COLLIER, Nadelhalter .....	208
BRÜNINGS-LUCAS, Flachmeißel .....	260	CHAPUT, Gewebefasszange .....	110	COLLIN, Bauchdeckenhalter .....	190
BRUNETTI, Meißel .....	268	CHARNLEY, Bauchdeckenhalter .....	289	COLLIN, Beckenzirkel .....	605
BRUNNER, Darmklemme .....	543	CHARRIERE, Amputationsäge .....	296	COLLIN, Darmfasszange .....	539
BRUNNER, Führungshohlsonde .....	221/1	CHEATLE, Sterilisierzange .....	227	COLLIN, Dynamometer .....	25
BRUNNER, Rippenschere .....	481	CHELSEA-EATON, Proktoskop .....	563	COLLIN, Gewebefasszange .....	110
BRUNNER, Wundhaken .....	167	CHERON, Tupferzange .....	137	COLLIN, Hammer .....	270
BRUNS, scharfer Löffel .....	251	CHEERY, Laminektomiesperrerr .....	488	COLLIN, Nabelschnurklemme .....	605
BRUNS, Verbandschere .....	70	CHEVALIER-JACKSON, Bronchoskopiezange .....	473	COLLIN, Scheidenspekula .....	570
Bruststütze, KLEINSASSER .....	36	CHEVALIER-JACKSON, Trachealkanüle .....	479	COLLIN, Sonde .....	586
Bruststütze, NEGUS .....	459	CHILDE, Wundklammerzange .....	224	COLLIN, Tupferzange .....	137
BRYANT, Tupferzange .....	137	chirurgische Nadel .....	222	COLLIN, Uterus-Fasszange .....	585
BUCHWALD, Zungenspatel .....	451	chirurgische Nadel, KEITH .....	223	COLLIN, Uterussonde .....	586
BUCK, Fremdkörperhebel .....	412	chirurgische Nadel, KOENIG .....	223	COLLIN, Wundhaken .....	139
BUCK, Ohrkürette .....	407	chirurgische Pinzette .....	81/1	COLLIN, Wundklammerzange .....	224
BUCK, Perkussionshammer .....	24	chirurgische Pinzette, ADLERKREUZ .....	84	COLLIN, Zungenzange .....	453
BUCK-GRAMCKO, Knochenhebel .....	285	chirurgische Pinzette, ADSON .....	81/2, 82	COLLIN-DUVAL, Fasspinzette .....	85
BUIE, Rektal-Absaugrohr .....	566	chirurgische Pinzette, ADSON-BROWN .....	82	COLLIN-HARTMANN, Wundhaken .....	141
Bulldogklemme, atrauma .....	100	chirurgische Pinzette, ADSON-Micro .....	82	COLLIN-LOKTITE, Bauchdeckenhalter .....	191
Bulldogklemme, DeBAKEY .....	103	chirurgische Pinzette, BONNEY .....	88	Columella-Pinzette, COTTLE .....	448
Bulldogklemme, GLOVER .....	103	chirurgische Pinzette, BROPHY .....	84	COLVER, Tonsillenfasszange .....	467
Bulldogklemme, JOHNS-HOPKINS .....	104	chirurgische Pinzette, BROWN .....	83	CONE, Schädelstanze .....	331
BÜLOW-GUNAR-HEY, Rollenklemme .....	130	chirurgische Pinzette, CUSHING .....	83	CONNIN-AMSLER, Markierungsinstrument .....	380
BUMM, Uteruskürette .....	597, 598	chirurgische Pinzette, FERRIS-SMITH .....	85	CONVERSE, Nasenhaken .....	448
BUNELL, Handbohrapparat .....	299	chirurgische Pinzette, GERALD .....	87	CONVERSE, Nasenmesser .....	435
BUNELL, Sehnenführer .....	294	chirurgische Pinzette, GILLIES .....	86	COOLEY, Anastomosenklemme .....	520/1
BUNELL, Sehnenschäler .....	292	chirurgische Pinzette, LANE .....	84	COOLEY, Aortaklemme .....	520/3
BUNGE, Exenterationslöffel .....	378	chirurgische Pinzette, LERCHE .....	83	COOLEY, Gefäßklemme .....	520/1 - 520/4
BUNT, Sterilisierklammer .....	227, 624	chirurgische Pinzette, McINDOE .....	85	COOLEY, Katheterklemme .....	510
BURCH, Fixiergabel .....	373	chirurgische Pinzette, OEHLER .....	81/1	COOLEY, Kinder-Gefäßklemmen .....	522
BURKE, Uterus-Biopsiezange .....	590	chirurgische Pinzette, POTTS-SMITH .....	81	COOLEY, Mehrzweck-Gefäßklemme .....	518 - 520
Bürstenspender .....	611	chirurgische Pinzette, SEMKEN .....	86	COOLEY, Rippensperrerr .....	485, 487
BUSCH, Nabelschnurschere .....	64	chirurgische Pinzette, Standard .....	81/1	COOLEY, Saugrohr .....	28
BUSHE, scharfer Löffel .....	256	chirurgische Pinzette, STILLE .....	81/1	COOLEY, Wundhaken .....	148
		chirurgische Pinzette, STILLE-BARRAYA .....	88	COOLEY-DERRA, Anastomosenklemme .....	519
		chirurgische Pinzette, STRASSBURGER MODELL .....	89	COOLEY-NEONATAL, Rippensperrerr .....	485
		chirurgische Pinzette, TAYLOR .....	87	COOPER, Unterbindungsnadel .....	219
		chirurgische Pinzette, WAUGH .....	83	CORDES, Aufsatz .....	472
		chirurgische Schere, DEAVER .....	52	CORONAL-BROW, Wundhaken .....	198
		chirurgische Schere, STANDARD .....	51	CORWIN-HEGAR, Drahtzange .....	319
		Cilienpinzette, BARRAQUER .....	395	CORYLLOS, Rippenschere .....	480
C					
CANFIELD, Tonsillennmesser .....	466				
CAPLAN, Nasenzange .....	428				
Cardiovascular-Klemme .....	526				
CARMALT, Splitterpinzette .....	91				
CAROLL, Sehnenfaßinstrument .....	293				

CORYLLOS, Wundhaken .....	166	Darmklemme, FEHLAND .....	542	DEMEL, Drahtspanninstrument .....	315
COS, Mikro-Ohrzängchen .....	414	Darmklemme, HAYES .....	545	DEMEL, Drahtumführungsnaedel .....	315
COTTLE, Bulldoggschere .....	56	Darmklemme, KOCHER .....	540	DENHART, Mundsperrer .....	454
COTTLE, Columella-Pinzette .....	448	Darmklemme, LANE .....	547	DENIS-BROWNE, Bauchdeckenhalter .....	185
COTTLE, Fixierpinzette .....	410	Darmklemme, MAYO-ROBSON .....	541	DERF, Nadelhalter .....	208
COTTLE, Hammer .....	273	Darmklemme, MIKULICZ .....	543	Dermatom, HUMBY .....	50
COTTLE, Hauthäkchen .....	447/1, 448	Darmklemme, PAYR .....	548	Dermatom, SCHINK .....	49
COTTLE, Knorpelquetscher .....	440	Darmklemme, RESANO .....	542	Dermatom, SILVER .....	50
COTTLE, Nasenhaken .....	447, 447/1	Darmklemme, SCUDDER .....	541	Dermatom, WATSON .....	50
COTTLE, Nasenmesser .....	435	Darmklemme, STONE-WATT .....	545	DERRA, Anastomosenklemme .....	515
COTTLE, Nasenschere .....	59	Darmschere .....	66	D'ERRICO, Nervwurzelhaken .....	329/2
COTTLE, Nasenspekula .....	423	Darmspatel .....	143/1 - 143/4	DESCHAMPS, Unterbindungsnaedel .....	218
COTTLE, Osteotom .....	440	Darmspatel, HABERER .....	143/3	DESJARDINS, Arterienklemme .....	121
COTTLE, Schere .....	56	Darmspatel, KADER .....	143/3	DESJARDINS, Gallensteinlöffel .....	534
COTTLE, Septumelelevator .....	439	Darmspatel, KÖRTE .....	143/3	DESJARDINS, Gallensteinsonde .....	531
COTTLE, Septummeißel .....	440	Darmspatel, KÜMMEL .....	143/4	DESJARDINS, Gallensteinzange .....	530/2
COTTLE-JOSEPH, Septumelelevator .....	439	Darmspatel, LERICHE .....	143/4	DESMARRES, Chalzationspinzette .....	393
COTTLE-KAZANJIAN, Knochensplitterzange .....	241	Darmspatel, REVERDIN .....	143/3	DESMARRES, Wundhaken .....	151
COTTLE-NEIVERT, Hauthäkchen .....	448	Darmspatel, RIBBON .....	143/1	DEUTSCHMANN, Starmesser .....	371
COXETER, Metallkatheter .....	555	Darm- u. Gewebefasszange, GREGOIRE .....	538	DeVILBISS, Schädelzange .....	332
CRAFOORD, Arterienklemme .....	118	DARTIGUES, Uterusfasszange .....	585	Diagnostik-Besteck ECO °C .....	16
CRAFOORD, Lungenschere .....	65/2	DASTOOR, Strabismuspinzette .....	386	Diagnostik-Besteck ECO °T .....	16
CRAFOOD-SELLORS, Arterienklemme .....	119	DAUBENSPECK, scharfer Löffel .....	255	Diagnostik-Besteck, RI-MINI .....	17
CREGO, Elevator .....	282	DAVIDSON (SCAPULA), Wundhaken .....	166	Diagnostik-Besteck, UNI III .....	15
CRILE, Arterienklemme .....	107	DAVIEL, Starlöffel .....	377	DIEFFENBACH, Gefäßsklemme .....	104
CRILE, Nadelhalter .....	213	DAVIS, Duradisektor .....	332	DIETER, Mikro-Ohrzängchen .....	414
CRILE, Nervhaken .....	328	DAVIS, Fremdkörpernaedel .....	374	DIETRICH, Aortaklemme .....	510
CRILE, Wundhaken .....	140	DAVIS, Hirnspatel .....	337	DIETRICH, Gefäßschere .....	60
CRILE-MURRAY, Nadelhalter .....	209	DAVIS, Sterilisierpinzette .....	227	DIETRICH, Mini-Bulldogklemme .....	101
CRILE-RANKIN, Arterienklemme .....	107	DAVIS-BOYLE, Mundsperrer .....	455	Dilatationsbougie, DITTEL .....	554
CRILE-WOOD, Nadelhalter .....	209	DAVIS-BOYLE, Sperrer .....	455	Dilatationsbougie, GUYON .....	554
CRITCHETT, Lidsperrer .....	370	DAVIS-BOYLE, Zugendrucker .....	455	Dilatationsbougie, VAN BUREN .....	554
CRUTCHFIELD, Bohrer .....	327	DAVIS-MEYER, Mundsperrer .....	457	Dilatator, BAKES .....	532
CRUTCHFIELD, Schädelhalter .....	327	DAY, Häkchen .....	409	Dilatator, CASTROVIEJO .....	381
CUSCO, Scheidenspekula .....	570, 571	DEAN, Irismesser .....	372	Dilatator, DeBAKEY .....	529
CUSHING, Bohrer .....	299	DEAN, Tonsillenschere .....	59	Dilatator, GOODELL .....	581
CUSHING, Hirnspatel .....	336, 369	DEAVER, Präparierschere .....	52	Dilatator, HANK .....	580
CUSHING, Laminektomie zange .....	340	DEAVER, Wundhaken .....	145, 146	Dilatator, HEGAR .....	578, 579
CUSHING, Nervenhaken .....	328	DEAVER-GRIP, Wundhaken .....	146	Dilatator, PRATT .....	580
CUSHING, Pinzette .....	83, 87	DeBAKEY, Anastomosenklemme .....	505	Dilatator, RITTER-HALLE .....	433
CUSHING, Wundhaken .....	151, 152	DeBAKEY, Aorta-Aneurysmaklemme .....	496 - 498	Dilatator, SIMS .....	581
CUSHING (TAYLOR), Pinzette .....	87	DeBAKEY, Aortaklemme .....	499, 500	Dilatator, WALTHER .....	555
CUZZI, Abortuslöffel .....	606	DeBAKEY, Atrauma-Bulldogklemme .....	103	Dilatator, WILDER .....	381
Cystotom, BECKER .....	375	DeBAKEY, Atrauma-Pinzette .....	98, 99	Dilatator, WYLIE .....	581
Cystotom, GRAEFTE .....	375	DeBAKEY, Bauchdeckenhalter .....	189/1	Dilatator, ZIEGLER .....	381
CZERNY, Hakenzange .....	584	DeBAKEY, Coarctationsklemme .....	507	DINGMANN, Elevator .....	463/3
CZERNY, Mastdarm-Spekula .....	559	DeBAKEY, Gefäßdilator .....	529	DINGMANN, Knochenhalte zange .....	246
CZERNY, Wundhaken .....	141	DeBAKEY, Gefäßklemme .....	493 - 499	DINGMANN, Mundsperrer .....	456
D		DeBAKEY, Gefäßschere .....	61	DINGMANN, Raspator .....	463, 463/3
DALE, Gefäßsklemme .....	494, 495	DeBAKEY, Ligaturklemme .....	499 - 500	DINGMANN, Sperrer .....	456
DANDY, Arterienklemme .....	109	DeBAKEY, Mehrzweck-Gefäßklemme .....	495, 508, 514 - 517	DIPLOMAT, Blutdruckmeßgerät .....	5
DANDY, Nervenhaken .....	328	DeBAKEY, Nadelhalter .....	210	Dissektor, FISCH .....	420
DARDIK, Gefäßsklemme .....	509/1	DeBAKEY, Saugrohr .....	28	Dissektor, GÖRNEY .....	277
DARLING, Wundspreser .....	178	DeBAKEY, Tangentialklemme .....	502	Dissektor, ROBB .....	530
Darmfasszange, ALLIS .....	537	DeBAKEY-BAHNSON, Aneurysmaklemme .....	506	Dissektor, PENFIELD .....	333
Darmfasszange, ALLIS-ADAIR .....	537	DeBAKEY-DIETRICH, Mini-Bulldogklemme .....	101	Diszisionsmesser, BERENS .....	372
Darmfasszange, ALLIS-BABY .....	537	DeBAKEY-MIXTER, Präparier- u. Ligaturklemme .....	499/2	Diszisionsmesser, CASTROVIEJO .....	372
Darmfasszange, atrauma .....	539	DeBAKEY-MOSQUITO, Atrauma-Arterienklemme .....	509	Diszisionsmesser, GRAEFFE .....	372
Darmfasszange, BABCOCK .....	539	DeBAKEY-PEAN, Atrauma-Arterienklemme .....	513	Diszisionsmesser, WHEELER .....	373
Darmfasszange, BOYS-ALLIS .....	538	DeBAKEY-RANKIN, Atrauma-Arterienklemme .....	512	Diszisionsmesser, ZIEGLER .....	373
Darmfasszange, COLLIN .....	539	DeBAKEY-RUMEL, Gefäßsklemme .....	499	Diszisionsnaedel .....	374
Darmfasszange, DOYEN-BABY .....	540	DeBAKEY-SATINSKY, Tangentialklemme .....	502	Diszisionsnaedel, BOWMAN .....	374
Darmfasszange, DOYEN .....	539	DeBOER, Rippersperrer .....	486	DITTEL, Dilatationsbougie .....	554
Darmfasszange, DUVAL .....	539	DECKER, Rongeur .....	341	DIX, Fremdkörperflächmeißel .....	374
Darmfasszange, JUDD-ALLIS .....	538	DEJERINE, Perkussionshammer .....	24	DIX, Fremdkörperinstrument .....	380
Darmfasszange, LITTLEWOOD .....	538	Dekapitationsshaken, BRAUN .....	607	Doppelkürlette .....	612
Darmfasszange, LOCKWOOD-ALLIS .....	538	deLEE, Geburtszange .....	602	Doppellöffel, VOLKMANN .....	257
Darmfasszange, THOMS-ALLIS .....	538	deLEE, Scheidenspekula .....	574	DOUGHTY, Zungenpatel .....	458
Darmfasszange, WILLIAMS .....	539	DeMARTEL, Führungsinstrument .....	330	DOUGLAS, Cliepinzette .....	395
Darmklemme, BABY-KOCHER .....	540	DeMARTEL-WOLFSON, Anastomosenklemme .....	546	DOUGLAS, Kieferhöhlenrotor .....	204
Darmklemme, BRUNNER .....	543	DeMARTEL-WOLFSON, Darmklemme .....	546	DOUGLAS, Tonsillensesser .....	466
Darmklemme, DeMARTEL-WOLFSON .....	546	DeMARTEL-WOLFSON, Klemmenhalterung .....	546	DOYEN, Bauchdeckenhalter .....	189/1
Darmklemme, DOYEN .....	540	DeMARTEL-WOLFSON, Klemmenschlusszange .....	546	DOYEN, Darmklemme .....	540

DOYEN, Hohlsonde.....	199	Elevator, DINGMAN.....	463, 463/3	Fadenpinzette, Mod. TUEBINGEN.....	392
DOYEN, Myomheber.....	594	Elevator, DINGMANN.....	463/3	Fadenpinzette, PAUFIQUE.....	392
DOYEN, Raspator.....	278	Elevator, FREER.....	434, 437, 439	Fadenschere, HEATH.....	66
DOYEN, Scheidenspekula.....	574	Elevator, HAJEK-BALLENGER.....	439	Fadenschere, LITTAUER.....	66
DOYEN, Schere.....	63	Elevator, HALLE.....	437	Fadenschere, NORTHBENT.....	66
DOYEN, Tuchklemme.....	133	Elevator, HOWARTH.....	438	Fadenschere, SPENCER.....	66
DOYEN, Uterus-Polypenzange.....	585	Elevator, JOSEPH.....	437	FANSLER, Proktoskop.....	564
DOYEN, Wundhaken.....	163	Elevator, KEY.....	282	FARABEUF, Knochenhalte-zange.....	243
DOYEN-BABY, Darmklemme.....	540	Elevator, KILLIAN.....	438, 439	FARABEUF, Raspator.....	274
DOYEN-JANSEN (MOLT), Mundsperrer.....	454	Elevator, LEMPERT.....	420	FARABEUF, Wundhaken.....	139
DOYEN-STILLE, Wundhaken.....	167	Elevator, MASING.....	437	FARABEUF-COLLIN, Raspator.....	274
Drahtbogen, ERICH.....	461/2	Elevator, McDONALD.....	283	FARABEUF-LAMBOTTE, Knochenhalte-zange.....	243
Drahtfasszange.....	316, 318	Elevator, McKENTY.....	437	FARRELL, Watteräger.....	203
Drahtgeflecht.....	311	Elevator, MURPHY-LANE.....	283	Fasspinzette.....	305
Drahtkneifzange.....	317 - 320/3	Elevator, OBWEGESER.....	461/1	Fasspinzette, COLLIN-DUVAL.....	85
Drahtsäge, OLIVECRONA.....	332	Elevator, PENNINGTON.....	438	Fasspinzette, DURANTE.....	88
Drahtschere, UNIVERSAL.....	67	Elevator, PIERCE.....	438	Fasspinzette, DUVAL.....	85
Drahtspanninstrument, DEMEL.....	315	Elevator, ROGER.....	437	Fasspinzette, LERCHE.....	83
Drahtspanninstrument, LOUTE.....	315	Elevator, SAYRE.....	281	Fasspinzette, RUSS. MODELL.....	85
Drahtumföhrungsnadel, DEMEL.....	315	Elevator, SINUS.....	438	Fasszange.....	316
Drahtvalven, Bauchdeckenhalter.....	184	Elevator, WATSON-CHEYNE.....	283	Fasszange, ALLIS.....	537
Drahtzange TC, BERRY.....	319	Elevator, YANKAUER.....	465	Fasszange, ALLIS-ADAIR.....	537
Drahtzange TC, CORWIN-HEGAR.....	319	ELLIOT, Geburtszange.....	603	Fasszange, ALLIS-BABY.....	537
Drahtzange TC, MAYO-HABERISSER.....	319	ELLIS, Fremdkörperhohlmeißel.....	374	Fasszange, BABCOCK.....	539
Dreibackenspannfutter Handgriff.....	300	ELSCHING, Fixationspinzette.....	389	Fasszange, BOYS-ALLIS.....	538
DUBOIS, Schere.....	63	ELSCHING, Hornhautmesser.....	373	Fasszange, COLLIN.....	539, 585
Duftstick.....	231/1	ELSCHING, Kapselpinzette.....	391	Fasszange, DARTIGUES.....	585
DUPLAY, Hakenzange.....	582	ELSCHING, Zykliodialysespatel.....	379	Fasszange, DOYEN.....	585
DUPLAY, Kornzange.....	134	EMMETT, Fistelhäkchen.....	594	Fasszange, DUVAL.....	539
DUPLEX, Stethoskop.....	23	Endarterektomie-Stripper.....	202	Fasszange, GREGOIRE.....	538
DUPIY-WEISS, Tonsillennadel.....	466	Endernagel, STEINMANN.....	307, 308	Fasszange, JUDD-ALLIS.....	538
Dura-Dissektor, DAVIS.....	332	Endoskopiekorb.....	623	Fasszange, KELLY.....	585
Dura-Dissektor, FRAZIER.....	333	Endospekula, KOGAN.....	577	Fasszange, LAHEY.....	479
Dura-Dissektor, HOEN.....	333	ENGL, Gipsäge.....	229	Fasszange, LANDOLT.....	341/2
Dura-Dissektor, HORSLEY.....	333	Enukleations-Löffel, WELLS.....	378	Fasszange, LITTLEWOOD.....	538
Dura-Dissektor, MILLIGAN.....	332	Episiotomie-Schere, BRAUN-STADLER.....	64	Fasszange, LOCKWOOD-ALLIS.....	538
Dura-Dissektor, OLIVECRONA.....	332	Episiotomie-Schere, WALDMANN.....	64	Fasszange, LOVEFACE.....	490
Dura-Dissektor, PENFIELD.....	333	EPKER, Osteotome.....	464/2	Fasszange, MARTEL.....	110
Dura-Dissektor, SACHS.....	332	EPPENDORFER, Uterus-Biopsiezange.....	590	Fasszange, McGIVNEY.....	568
Dura-Dissektor, TOENNIS.....	332	ERBE, Verbindungskabel.....	633	Fasszange, MILLIN.....	550, 551
Dura-Dissektor, WOODSON.....	333	ERBE/SELECT, Verbindungskabel.....	633	Fasszange, NOTO.....	585
Dura-Haken.....	335	ERICH, Drahtbogen.....	461/2	Fasszange, PRATT.....	110
Dura-Haken, ADSON.....	329	ERRICO, Bohrer.....	299	Fasszange, YOUNG.....	550
Dura-Haken, JACOBSON.....	335	Ersatzklinge.....	49, 50	Fasszange, SERPENTINE-GRASPER.....	593
Dura-Messer, KOOS.....	335	Ersatzlämpchen.....	29, 30	Fasszange, SOMER.....	585
DURANTE, Fasspinzette.....	88	Ersatzsägeblätter.....	230	Fasszange, WILLET-MARTEL.....	110
Dura-Schere, SCHMIEDEN-TAYLOR.....	65/1	Ersatzteilst, HERCULES.....	320/1 - 320/3	Fasszange, WILLIAMS.....	539
DUVAL, Darmfasszange.....	539	ESMARCH, Gipsmesser.....	233	FAULKNER, Kürette.....	449
DUVAL, Fasspinzette.....	85	ESMARCH, Staubinde.....	296	FAURE, Biopsiezange.....	588
Dynamometer, COLLIN.....	25	ESMARCH, Verbandschere.....	69/2	FAURE, Peritoneumklemme.....	123
E		ETHICON, Cilparlegезange.....	524, 525	FAVALORO, Gefäßschere.....	61
ECHLIN, Hohlmeißelzange.....	240	EVES, Tonsillenschnürer.....	468	FEHLAND, Darmklemme.....	542
ECO "C" Diagnostik-Besteck.....	16	EXACTA, Blutdruckmessgerät.....	8	FEILCHENFELD, Splitterpinzette.....	91
ECO "T" Diagnostik-Besteck.....	16	Exenterationslöffel, BUNGE.....	378	FELDHEIM, Knochenhalteklammer.....	249
EICKEN (KILLIAN), Spülkanüle.....	433	Extensionsbügel, BOEHLER.....	312	FERGUSSON, Gallensteinlöffel.....	533
Ein- u. Ausschluginstrumente.....	321	Extensionsbügel, KIRSCHNER.....	312	FERGUSSON, Hämorrhoidalklemme.....	109
Einschläger, BENDER.....	322/1	Extensionsbügel, KIRSCHNER US.....	312	FERGUSSON, Knochenhalte-zange.....	243
Elektrode, monopolar.....	629	Extirpationsmeißel, ROLLET.....	374	FERGUSSON, Saugrohr.....	337
Elektrodenball-Koagulation.....	629	Extraktor.....	322/1	FERGUSSON, Schere.....	66
Elektroden-Drahtschlinge.....	629	Extraktionshaken.....	322	FERGUSSON-FRAZIER, Saugrohr.....	337
Elektroden-Koagulation.....	629	Extraktionshaken, ARRUGA.....	375	FERRIERA, Wundhaken.....	197
Elektroden-Lanzette.....	629	Extraktionshaken, I.U.D.....	593	FERRIS-SMITH, Laminektomie-zange.....	343
Elektroden-Nadel.....	629	Extraktor, KUENTSCHER.....	322	FERRIS-SMITH, Pinzette.....	85
Elektroden-Schlinge.....	628, 629	Exzentrische Begrenzungsscheibe.....	230/17	FERRIS-SMITH-KERRISON, Bandscheibenstanze...344, 344/2	
Elevator.....	280	F		Fertigschläger, KUENTSCHER.....	321
Elevator, ALDERDYCE.....	282	Face-Lift-Schere, FREEMAN.....	74	Fiberglas-Lichtträger, KLEINSASSER.....	36
Elevator, BALLENGER.....	439	Face-Lift-Schere, GORNEY.....	73	Filtervlies f. Gipsäge.....	230/18
Elevator, BOIES.....	277	Face-Lift-Schere, KAYE.....	73	Finger-Goniometer.....	25
Elevator, CHANDLER.....	282	Face-Lift-Schere, REES.....	73	Fingerringssäge, REDA.....	297
Elevator, COTTLE.....	439	Fadengabel, REDA.....	221	Fingerringssäge, WALTON.....	297
Elevator, COTTLE-JOSEPH.....	439	Fadengabel, Tracheotomie.....	475	Fingersäge, LANGENBECK.....	296
Elevator, CREGO.....	282	Fadenpinzette, McPHERSON.....	392	Fingerschützer, LANGENBECK.....	311
				FINOCHIETTO, Bronchusklemme.....	490



FINOCHIETTO, Nadelhalter.....	211	Fremdkörperkürette, ALVIS .....	374	Gefäßscilip, MÜLLER.....	365
FINOCHIETTO, Rippensperrerr.....	482, 484	Fremdkörpernadel.....	374	Gefäßscilip, YASARGIL.....	345 - 356
FINOCHIETTO-BABY, Rippensperrerr.....	482	Fremdkörpernadel, DAVIS.....	374	Gefäßsdilatator, DeBAKEY.....	529
FINOCHIETTO-BURFORD, Rippensperrerr.....	483	Fremdkörpernadel, FRANCIS.....	374	Gefäßsdissektor, ROBB.....	530
FINSEN, Wundhaken.....	168	Fremdkörpernadel, LA FORCE.....	374	Gefäßsklemme, atrauma.....	492, 495/1, 495/2, 523 - 527
FISCH, Dissektor.....	420	Fremdkörpernadel, LEVINSON.....	374	Gefäßsklemme, BAINBRIDGE.....	495/1, 495/2
FISCH, feines Häkchen.....	335	Fremdkörperzängchen, HARTMANN.....	412	Gefäßsklemme, BECK.....	520
FISCHER, Irispinzette.....	384	Fremdkörperzängchen, HARTMANN-HOFFMANN.....	412	Gefäßsklemme, COOLEY.....	510, 518 - 522
FISH, Sonde.....	199	Fremdkörperzängchen, HARTMANN-WULLSTEIN.....	412	Gefäßsklemme, COOLEY-DERRA.....	519
FISHER, Tonsillennmesser.....	466	Fremdkörperzängchen, STRUEMPEL.....	412	Gefäßsklemme, DALE.....	494, 495
Fistelhäkchen, EMMETT.....	594	Fremdkörperzange, MATHIEU.....	553/1	Gefäßsklemme, DARDIK.....	509/1
Fistelsonde, LOCKHART-MUMMERY.....	200	FRENZEL, Nystagmusbrille.....	20	Gefäßsklemme, DeBAKEY.....	493 - 517
Fistelsonde, PRAIT.....	563	FRENZEL, Zungenspatel.....	451	Gefäßsklemme, DeBAKEY-BAHNSON.....	506
Fixationspinzette, BARRAQUER.....	390	FRIEDMAN, Hohlmeisselzange.....	234	Gefäßsklemme, DeBAKEY-BECK.....	516
Fixationspinzette, ELSCHNIG.....	389	FRIEDMANN, Spektula.....	577	Gefäßsklemme, DeBAKEY-MIXTER.....	499/2
Fixationspinzette, GRAEFE.....	389	FRITSCH, Wundhaken.....	163	Gefäßsklemme, DeBAKEY-MOSQUITO.....	509
Fixationspinzette, GREEN.....	390	FRYKHOLM, Hohlmeisselzange.....	240	Gefäßsklemme, DeBAKEY-PEAN.....	513
Fixationspinzette, LESTER.....	389	FUCHS, Kapselpinzette.....	391	Gefäßsklemme, DeBAKEY-RANKIN.....	512
Fixiergabel, BURCH.....	373	FUCHSIG, Arterienklemme.....	113	Gefäßsklemme, DeBAKEY-RUMEL.....	499
Fixierpinzette, CASTROVIEJO.....	390	Führungshohlsonde, BRUNNER.....	221/1	Gefäßsklemme, DeBAKEY-SATINSKY.....	502
Fixierpinzette, COTTLE.....	410	Führungshohlsonde, KIRSCHNER.....	221	Gefäßsklemme, DERRA.....	515
Fixierpinzette, GRAEFE.....	83	Führungshohlsonde, KOENIG.....	221/1	Gefäßsklemme, DIEFFENBACH.....	104
Fixierpinzette, KIRBY-ARTHUR.....	385	Führungshohlsonde, PAYR.....	221/1	Gefäßsklemme, DIETRICH.....	510
Fixiervorrichtung, LEYLA.....	368/1	Führungshohlsonde, REDA.....	221/1	Gefäßsklemme, GLOVER.....	515
Fixiervorrichtung, ROCHARD.....	186	Führungshohlsonde, SCHMIEDEN.....	221	Gefäßsklemme, GREGORY.....	517
Flachbohrer, CUSHING.....	299	Führungshohlsonde, SCHMIEDEN-PAYR.....	221	Gefäßsklemme, HARKEN.....	503
Flachmeissel.....	259, 264, 267	Führungshohlsonde, VIENNA.....	221/1	Gefäßsklemme, JAVID.....	511
Flachmeissel, ALEXANDER.....	259	Führungsinstrument, DeMARTEL.....	330	Gefäßsklemme, LAMBERT-KAY.....	505
Flachmeissel, BRÜNINGS-LUCAS.....	260	Führungsnadel, REDON.....	207	Gefäßsklemme, LEES.....	504
Flachmeissel, Ferrozellgriff.....	264	Führungsspiess.....	321	Gefäßsklemme, LELAND-JONES.....	495
Flachmeissel, HIBBS.....	265	G.....		Gefäßsklemme, MORRIS-DeBAKEY.....	506
Flachmeissel, HOKE.....	265	Galeahaken, YASARGIL.....	330	Gefäßsklemme, POTTS.....	492, 493
Flachmeissel, LEXER.....	263	GALLAHER, Antrumraspel.....	446	Gefäßsklemme, SATINSKY.....	491
Flachmeissel, NOVOTEX-Griff.....	264	Gallenblasenschere, THOREK.....	65/2	Gefäßsklemme, SUBRAMANIAN.....	521
Flachmeissel, PARTSCH.....	259	Gallengangdilator, BAKES.....	532	Gefäßsklemme, WEBER.....	501
Flachmeissel, STILLE.....	260	Gallensteinlöffel, DESJARDINS.....	534	Gefäßsklemme, WYLIE.....	501/1, 501/2
Flachzange.....	316, 317	Gallensteinlöffel, FERGUSON.....	533	Gefäßmesser, KOOS.....	335
flexible Fasszange, SERPENTINE-GRASPER.....	593	Gallensteinlöffel, LUER-KOERTE.....	533	Gefäßpinzette, ADLERKREUTZ.....	84
flexibler Hirnsattelhalter, LEYLA.....	368/2	Gallensteinlöffel, MAYO.....	534	Gefäßpinzette, NELSON.....	89
flexibler Spannarm, LEYLA.....	368/3	Gallensteinlöffel, MOOR.....	531	Gefäßpinzette, STILLE-BARRAYA.....	88
FOERSTER, Irispinzette.....	383	Gallensteinlöffel, MOOR.....	531	Gefäßpinzette, WANGENSTEEN.....	89
FOERSTER, Tupferzange.....	136	Gallensteinsonde, DESJARDINS.....	531	Gefäßschere, DeBAKEY.....	61
FOMON, Hauthäkchen.....	447/1	Gallensteinsonde, MAYO.....	534	Gefäßschere, DIETRICH.....	60
FOMON, Nasenhaken.....	447/1	Gallensteinsonde, MOYNIHAN.....	531	Gefäßschere, FAVALORO.....	61
FOMON, Nasenraspel.....	444, 445	Gallensteinzange, BLAKE.....	530/2	Gefäßschere, KELLY.....	61
FOMON, Nasenschere.....	58	Gallensteinzange, DESJARDINS.....	530/2	Gefäßschere, KLINKENBERG-LOTH.....	65/2
FOMON, Rasptator.....	277	Gallensteinzange, MAYO-BLAKE.....	530/2	Gefäßschere, POTTS-DeMARTEL.....	59
FOMON, Rhinoplastschere.....	65/1	Gallensteinzange, MIXTER.....	530/2	Gefäßschere, POTTS-SMITH.....	61
FOMON, Septummeissel.....	441	GASS, Häkchen.....	376	Gefäßschere, SATINSKY.....	65/2
FOX, Lupuskürette.....	608	GAUSS, Kopfschwarte.....	605	Gefäß-Spülkanüle, SCHMID.....	338
FRAENKEL, Aufsatz.....	472	Geburtslöffel, SELLHEIM.....	607	GELPI, Bauchdeckenhalter.....	189/1, 189/2
FRAENKEL, Kehlkopfpolypenzange.....	471	Geburtszange.....	602 - 604	GELPI, Haken.....	193
FRANCIS, Fremdkörpernadel.....	374	Geburtszange, BARTON.....	603	GEMINI, Arterienklemme.....	115
FRAZIER, Bauchdeckenhalter.....	181	Geburtszange, BOERMA.....	604	GERALD, Pinzette.....	86, 87
FRAZIER, Dura-Dissektor.....	333	Geburtszange, DeLEE.....	602	GERSTER, Knochenhalteklammer.....	250
FRAZIER, Hauthäkchen.....	148/2	Geburtszange, ELLIOT.....	602	GERZOG, Hammer.....	270
FRAZIER/FERGUSON, Punktionskanüle.....	337	Geburtszange, KIELLAND.....	602	Gewebe-fasspinzette, BROWN.....	83
FRAZIER/FERGUSON, Saugrohr.....	337	Geburtszange, KIELLAND-LUIKART.....	603	Gewebe-fasspinzette, SINGLEY.....	88
FREEMAN, Face-Lift-Schere.....	74	Geburtszange, LUIKART.....	603	Gewebe-fasszange, CHAPUT.....	110
FREEMAN, Wundhaken.....	198	Geburtszange, McLEAN.....	603/1	Gewebe-fasszange, COLLIN.....	110
FREER, Elevatorium.....	437	Geburtszange, McLEAN-LUIKART.....	603/1	Gewebe-fasszange, GREGOIRE.....	538
FREER, Hauthäkchen.....	448	Geburtszange, McLEAN-TUCKER.....	603/1	Gewebe-fasszange, TUFFIER.....	110
FREER, Nasenmesser.....	434	Geburtszange, McLEAN-TUCKER-LUIKART.....	603/1	Gewicht, AUWARD.....	576
FREER, Septum-elevator.....	437, 439	Geburtszange, NAEGELE.....	602	Gewicht, SCHERBAK.....	575
FREER, Septumhohlmeissel.....	442/1	Geburtszange, PIPER.....	604	GIERTZ-STILLE, Rippenschere.....	481
FREER, Septummeissel.....	439	Geburtszange, SIMPSON.....	602	GILLI, Säge.....	332
FREER, Septummesser.....	434	Geburtszange, SIMPSON-BRAUN.....	602	GILLI, Hornhautmesser.....	373
Fremdkörper-fachmeissel, DIX.....	374	Geburtszange, SIMPSON-LUIKART.....	603	GILL, Irispinzette.....	384
Fremdkörperhebel, BUCK.....	412	Geburtszange, TARNIER.....	604	GILL-ARRUGA, Kapselpinzette.....	390
Fremdkörperhebel, QUIRE.....	412	Geburtszange, THIERRY.....	603	GILL-HESS, Irispinzette.....	384
Fremdkörperhohlmeissel, ELLIS.....	374	Geburtszange, WRIGLEY.....	602	GILLIES, Hauthäkchen.....	448
Fremdkörperhohlmeissel, WALTON.....	374	Gefäßscilip, BIEMER.....	361	GILLIES, Nadelhalter.....	212
Fremdkörperinstrument, DIX.....	380	Gefäßscilip, MEHDORN.....	362	GILLIES, Pinzette.....	86

GIL-VERNET, Wundhaken.....	152	GUYON, Nierenklemme.....	122	Haken, TAYLOR.....	196
Gipsabreisszange, WOLFF.....	233	GUYTON-LUNGSGAARD, Sklerotom.....	373	Haken, TESSIER.....	463/3
Gipsmesser, ESMARCH.....	233	Gynäkologie-Schere, DOYEN.....	63	Hakenzange, ADAIR.....	582
Gipsmesser, HOPKINS.....	233	Gynäkologie-Schere, DUBOIS.....	63	Hakenzange, BARRET.....	582
Gipsmesser, REINER.....	233	Gynäkologie-Schere, SIEBOLD.....	62	Hakenzange, BRAUN.....	582
Gipsmesser, WIGMORE.....	229	Gynäkologie-Schere, SIMS.....	62	Hakenzange, CZERNY.....	584
Gipssäge, elektrisch.....	230			Hakenzange, DUPLAY.....	582
Gipssäge, ENGEL.....	229	H		Hakenzange, HULKA.....	583
Gipssäge, oszillierend.....	230/10, 230/12	HABERER, Darmspatel.....	143/3	Hakenzange, IOWA.....	584
Gipsschere, STILLE.....	229	Hämorrhoidal-Klemme, FERGUSSON.....	109	Hakenzange, JACOBS.....	583
Gipsspreizer, BEESON.....	232	Hämorrhoidal-Ligatur, McGIVNEY.....	568	Hakenzange, JARCHO.....	583
Gipsspreizer, HAGLUND-STILLE.....	232	HAGLUND-STILLE, Gipsspreizer.....	232	Hakenzange, MUSEUX.....	583
Gipsspreizer, HENNIG.....	232	HAIGHT, Rippensperre.....	487	Hakenzange, POZZI-PALMER.....	582
Gipsspreizer, REDA.....	232	HAJEK, Hammer.....	273	Hakenzange, PRATT.....	584
GLOVER, Bulldogklemme.....	103	HAJEK, Septummeißel.....	442/1	Hakenzange, SCHRÖDER.....	583, 584
GLOVER, Mehrzweckklemme.....	515	HAJEK-BALLENGER, Elevator.....	439	Hakenzange, SCHRÖDER (POZZI).....	582
GLUCK, Rippenschere.....	480	HAJEK-KOFLER, Stanze.....	429, 431	Hakenzange, SKENE.....	582
GOELET, Wundhaken.....	141	Häkchen, ARRUGA.....	375	Hakenzange, STAUDE-MOORE.....	582
GOLDMANN-FOX, Zahnfleischschere.....	67	Häkchen, BARBARA.....	419	Hakenzange, TEALE.....	583
GOMMEL, Pinzette.....	96	Häkchen, BECKER.....	375	HALLE, scharfer Löffel.....	253
GOMMEL, Schere.....	80	Häkchen, BOSE.....	477	HALLE, Septumellevator.....	437
Goniometer f. Finger.....	25	Häkchen, CLAYMAN.....	376	Halogenlampe.....	29
Goniotomiemesser, BARKAN.....	373	Häkchen, CONVERSE.....	448	HALSEY, Nadelhalter.....	208
Goniotomiemesser, SCHEIE.....	373	Häkchen, COTTLE.....	447/1	HALSTED-MOSQUITO, Arterienklemme.....	105
GOOD, Tonsillenschere.....	59	Häkchen, COTTLE-NEIVERT.....	448	Haltearm, LEYLA.....	368/1
GOODELL, Uterus-Dilatator.....	581	Häkchen, DAY.....	409	Halteklemme, ADSON.....	298
GORNEY, Dissektor.....	277	Häkchen, FISCH.....	335	Halter, Hirnspatel, LEYLA.....	368/4
GORNEY, Face-Lift-Schere.....	73	Häkchen, FOMON.....	447/1	Halter, KALLMORGEN.....	573
GOSSET, Bauchdeckenhalter.....	181	Häkchen, FREER.....	448	Halter, KRISTTELLER.....	572
GOURDET, Uteruslöffel.....	599	Häkchen, GASS.....	376	Halterahmen.....	187
GRADLE, Pinzette.....	395	Häkchen, GILLIES.....	448	Haltezange, LANE.....	325
GRADLE, Schere.....	57	Häkchen, GRAEFE.....	375	Hammer.....	270 - 273
GRAEFE, Cystotom.....	375	Häkchen, GREEN.....	375	Hammer, BERGMANN.....	272
GRAEFE, Disziionsmesser.....	372	Häkchen, JAMESON.....	375	Hammer, COLLIN.....	270
GRAEFE, Fixationspinzette.....	389	Häkchen, KILNER.....	447/1, 608	Hammer, COTTLE.....	273
GRAEFE, Fixierpinzette.....	83	Häkchen, KNAPP.....	375	Hammer, Ferrozellgriff.....	272
GRAEFE, Hauthäkchen.....	148/2	Häkchen, KRAYENBÜHL.....	336	Hammer, GERZOG.....	270
GRAEFE, Irispinzette.....	382	Häkchen, KUGLEN.....	376	Hammer, HAJEK.....	273
GRAEFE, Lidsperrerr.....	370	Häkchen, LANGE.....	448	Hammer, HEATH.....	273
GRAEFE, Schere.....	56	Häkchen, LUCAE.....	409	Hammer, KIRK.....	270
GRAEFE, Schielhaken.....	375	Häkchen, McGEE.....	419	Hammer, LUCAE.....	271
GRAEFE, Starlöffel.....	377	Häkchen, O'CONNOR.....	375	Hammer, MEAD.....	271
GRAEFE, Starmesser.....	371	Häkchen, ROLLET.....	375	Hammer, OMBREDANNE.....	273
GRAHAM, Nervhaken.....	329	Häkchen, SHAMBAUGH.....	419	Hammer, PARTSCH.....	271
GRAIG, Septumzange.....	426	Häkchen, SINSKEY.....	376	Hammer, QUISLING.....	271
GRAVE, Scheidenspekula.....	570	Häkchen, STEVENS.....	375	Hammer, WILLIGER.....	271
GRAY, Arterienklemme.....	121	Häkchen, Tracheotomie.....	475	Hämorrhoidal-Ligatur.....	568
GREEN, Fixationspinzette.....	390	Häkchen, WAGENER.....	409	Hämorrhoidal-Ligatur, RUDD.....	568
GREEN, Hornhautdissektor.....	374	Häkchen, WIENER.....	375	Hämorrhoidal-Zange, HEYWOOD-SMITH.....	567
GREEN, Muskelhäkchen.....	375	Haken, AUFRICHT.....	447	Hämorrhoidal-Zange, McGIVNEY.....	568
GREEN, Wundhaken.....	160	Haken, BALFOUR.....	193	Handbohrapparat, BUNELL.....	299
GREEN-ARMYTAGE, Uteruszange.....	605	Haken, BRAUN.....	607	Handbohrapparat, HUDSON.....	299
GREGOIRE, Darm- u. Gewebefasszange.....	538	Haken, COTTLE.....	447, 447/1	Handbohrapparat, KIRSCHNER.....	299
GREGORY, Profundaklemme.....	517	Haken, GELPI.....	193	Handbohrapparat, MOORE.....	298
GREVEN, Ohrzängchen.....	414	Haken, HARGIS.....	463/6	Handbohrapparat, RALK.....	300
Griff, Kehlkopfspiegel.....	473	Haken, HARRINGTON.....	193	Handbohrapparat, REDA.....	300
Griff, Meißel.....	266	Haken, HOFER.....	465	Handbohrapparat, STILLE.....	298
Griff, Osteotome.....	266	Haken, ITERSON.....	477	Handgriff.....	300
Griff, SCHERBAK.....	575	Haken, JACKSON.....	476	Handgriff Dreibackenspannfutter.....	300
Griff, Skalpell.....	38 - 41	Haken, KELLY.....	193	Handgriff, NABATOFF.....	201
Griff, Skalpell Mini.....	41	Haken, KIRSCHNER.....	185, 187	Handgriff, Stabinstrumente f. Tracheotomie.....	475
Griff, Stabinstrumente, Tracheotomie.....	475	Haken, LOVE.....	465	Handwaschbürste.....	611
Griff, Uterus-Biopsiezangen.....	591	Haken, MASING.....	447	HANK, Uterus-Dilatator.....	580
GROSS, Ohrlöffel.....	409	Haken, MASING-NEIVERT.....	447	HARGIS, Raspator.....	463/2
GROSS-MAIER, Kornzange.....	134	Haken, NAGER.....	465	HARGIS, Unterkieferhaken.....	463, 463/6
GRUBER, Ohrspekula.....	399	Haken, NEWS.....	477	HARGIS, Wundhaken.....	463
GUILLEN, Saugraspatorium.....	433/1	Haken, OBWEGESER.....	460, 461/1	HARKEN, Aurikelklemme.....	503
Gummibirne, POLITZER.....	406	Haken, YOUNG.....	550	HARMS, Sonde.....	381
Gummiringe-Ligatur, McGIVNEY.....	568	Haken, RAMUS.....	461	HARRINGTON, Bronchusklemme.....	490
GUTHRIE, Hauthäkchen.....	148/2	Haken, SCHOENBORN.....	479	HARRINGTON, Haken.....	193
GUYON, Arterienklemme.....	122	Haken, SCOVILLE.....	196	HARRINGTON, Wundhaken.....	147
GUYON, Dilatationsbougie.....	554	Haken, SMELLIE.....	605	HARRINGTON-PEMBERTON, Wundhaken.....	147
GUYON, Katheter-Einführungsinstrument.....	554	Haken, SPINA-NASALIS.....	461	HARTMANN, Arterienklemme.....	104

HARTMANN, Fremdkörperzängchen .....	412	Hochfrequenz-Chirurgie .....	628, 629	HOUSE, Kürette .....	420
HARTMANN, Nasenspekula .....	422	HOEN, Dura-Dissektor .....	333	HOUSE, Mikro-Messsonde .....	420
HARTMANN, Nasenzange .....	427	HOESEL, Nadelhalter .....	213	HOUSE, Saugrohr .....	337/2
HARTMANN, Ohrkatheter .....	408	HOFFER, Wundhaken .....	465	HOWARTH, Septumlevator .....	438
HARTMANN, Ohrspekula .....	399	HOFFMANN, Schlauchklemme .....	624	HUBER, Universalgriff .....	472
HARTMANN, Ohrzängchen .....	411	Hohlmeißel .....	259, 264	HUDSON, Handbohrapparat .....	299
HARTMANN, Polypenzange .....	424	Hohlmeißel, ALEXANDER .....	259	HUDSON, T-Handgriff .....	300
HARTMANN, Stimmgabel .....	403	Hohlmeißel, COBB .....	262	HULKA, Hakenzange .....	583
HARTMANN, Zungendrucker .....	452	Hohlmeißel, HIBBS .....	265	HUMBY, Dermatomb .....	50
HARTMANN-HALLE, Nasenspekula .....	421	Hohlmeißel, KILLIAN .....	442/1	HUNTER, Splitterpinzette .....	91
HARTMANN-HOFFMANN, Fremdkörperzängchen .....	412	Hohlmeißel, LEXER .....	263	HURD, Tonsillen-Dissektor .....	465
HARTMANN-WULLSTEIN, Fremdkörperzängchen .....	412	Hohlmeißel, LEXER-Mini .....	263	Hypophysenkürette, RAY .....	334
HASSON, Wundhaken .....	143	Hohlmeißel, NOVOTEX .....	264	Hypophysenpinzette, ADSON .....	334
HAUGH, Mikro-Ohrzängchen .....	414	Hohlmeißel, PARTSCH .....	259	Hypophysenzange .....	341
Hauthäkchen, COTTLE .....	447/1	Hohlmeißel, SMITH-PETERSEN .....	261	Hysterektomieklammer, HEANEY .....	126
Hauthäkchen, COTTLE-NEIVERT .....	448	Hohlmeißel, STILLE .....	260	Hysterektomieklammer, HEANY-BALLENTINE .....	127
Hauthäkchen, FOMON .....	447/1	Hohlmeißel, WEST .....	442/1	Hysterektomieklammer, HOLZBACH .....	126
Hauthäkchen, FRAZIER .....	148/2	Hohlmeißel, ZIELKE .....	264	Hysterektomieklammer, MAINGOT .....	123/1, 123/2
Hauthäkchen, FREER .....	448	Hohlmeißelzange, ADSON .....	236	Hysterektomieklammer, ROGERS .....	127
Hauthäkchen, GILLIES .....	448	Hohlmeißelzange, BANE-HARTMANN .....	237	Hysterektomieklammer, SEGOND .....	125
Hauthäkchen, GRAEFE .....	148/2	Hohlmeißelzange, BEYER .....	237	Hysterektomieklammer, SEGOND-LANDAU .....	125
Hauthäkchen, GUTHRIE .....	148/2	Hohlmeißelzange, BLUMENTHAL .....	236	Hysterektomieklammer, WERTHEIM .....	124, 128
Hauthäkchen, JOSEPH .....	149	Hohlmeißelzange, BÖHLER .....	238	Hysterektomieschere, WERTHEIM .....	63
Hauthäkchen, KILNER .....	608	Hohlmeißelzange, CLEVELAND .....	235		
Hauthäkchen, KLAPP .....	150	Hohlmeißelzange, ECHLIN .....	240	I	
Hauthäkchen, KLEINERT-KUTZ .....	149	Hohlmeißelzange, FRIEDMAN .....	234	I.U.D., Extraktionshaken .....	593
Hauthäkchen, LAHEY .....	149	Hohlmeißelzange, FRIEDMAN-Micro .....	234	Impaktor .....	322/1
Hauthäkchen, REDA .....	150	Hohlmeißelzange, FRIEDMAN-Mini .....	234	Impulschüssel .....	230/18
Haut-Trephinen, KEYE .....	608	Hohlmeißelzange, FRYKHOLM .....	240	INGE, Wirbelkörperspreizer .....	339
HAYES, Darmklemme .....	545	Hohlmeißelzange, JANSEN .....	237	INGROWN, Nagelinstrument .....	612/1
HAYES, Rektum-Anastosenklemme .....	545	Hohlmeißelzange, KLEINERT-KUTZ .....	237	Injektionskanüle .....	36
HEANEY, Hysterektomieklammer .....	126	Hohlmeißelzange, LEKSELL (STILLE) .....	240	INSTRU-CARE, Instrumentenöl .....	635
HEANEY, Nadelhalter .....	210	Hohlmeißelzange, LEMPERT .....	237	Instrumente f. Tracheotomie .....	475
HEANY, Biopsiekürette .....	587	Hohlmeißelzange, LUER .....	236	Instrumentenkasten .....	617
HEANY, Wundhaken .....	164	Hohlmeißelzange, MARQUARDT .....	239	Instrumentenöl, INSTRU-CARE .....	635
HEANY-BALLENTINE, Hysterektomieklammer .....	127	Hohlmeißelzange, MAYFIELD .....	238	Insufflationskanüle, VERESS .....	206
HEATH, Fadenschere .....	66	Hohlmeißelzange, MEAD .....	235	Intraorale Retraktoren .....	463/1, 463/4
HEATH, Hammer .....	273	Hohlmeißelzange, OLIVECRONA .....	237	Inzisionsschere .....	52
HEBRA, Chalazionskürette .....	377	Hohlmeißelzange, RUSKIN .....	239	IOWA, Hakenzange .....	584
HEGAR, Uterus-Dilatator .....	578, 579	Hohlmeißelzange, SAUERBRUCH .....	240	IOWA, Nadelführer .....	206
HEGENBARTH, Wundklammerpinzette .....	224	Hohlmeißelzange, SCAGLIETTI .....	240	IRIS, Schere .....	54/2
HEIFETZ, Hirnspatel .....	369	Hohlmeißelzange, SEMB .....	240	Irisschere, KNAPP .....	55
HEIMING, Nierensteinzange .....	536	Hohlmeißelzange, SMITH-PETERSEN .....	238	Irisschere, LITTLER .....	55
HEISS, Arterienklemme .....	112	Hohlmeißelzange, STELLBRINK .....	234	IRIS, Supercuttschere .....	72
HEISTER, Mundsperrer .....	454	Hohlmeißelzange, STILLE-LUER .....	239	Irishäkchen, O'CONNOR .....	375
Hemilaminektomiespreizer, DARLING .....	178	Hohlmeißelzange, STILLE-RUSKIN .....	239	Irishäkchen, WIENER .....	375
HENKE, Tonsillenelevator .....	465	Hohlmeißelzange, ZAUFAL-JANSEN .....	238	Irismesser, DEAN .....	372
HENLEY, Wundspreizer .....	170	Hohlsonde .....	199	Irismesser, KNAPP .....	372
HENNIG, Gipsspreizer .....	232	Hohlsonde, BRODIE .....	199	Irismesser, ZIEGLER .....	372
HEPA-Filter .....	231/1	Hohlsonde, DOYEN .....	199	Irispinzette, BARRAQUER .....	384
HEPP-SCHUIDEL, Schere .....	78	Hohlsonde, NELATON .....	199	Irispinzette, BARRAQUER-KATZIN .....	384
HERCULES, Drahtkniefzange .....	320/1 - 320/3	HOHMANN, Knochenheber .....	284, 285	Irispinzette, BISHOP-HARMAN .....	386
HERRICK, Nierenstielklemme .....	123	HOHMANN-Mini, Knochenheber .....	286	Irispinzette, BONN .....	387
HESS, Irispinzette .....	384	HOKE, Flachmeißel .....	265	Irispinzette, FISCHER .....	384
HESS, Kapselpinzette .....	391	HOKE, Osteotome .....	265	Irispinzette, FOERSTER .....	383
HESS, Nervwurzelhaken .....	329/1	HOLINGER, OP-Laryngoskop .....	37	Irispinzette, GILL .....	384
HEYMANN, Nasenschere .....	58	HOLLINGER, Lichtträger .....	37	Irispinzette, GILL-HESS .....	384
HEYMANN, Septumzange .....	425	HOLSHER, Nervwurzelhaken .....	329/1	Irispinzette, GRAEFE .....	382
HEYMANN-KNIGHT, Polypenzange .....	425	HOLTH, Kapselstanze .....	380	Irispinzette, HESS .....	384
HEYWOOD-SMITH, Hämorrhoidalzange .....	567	HOLZBACH, Hysterektomieklammer .....	126	Irispinzette, STEVENS .....	383
HIBBS, Flachmeißel .....	265	HOLZHEIMER, Wundhaken .....	168	Irispinzette, TROUTMAN .....	384
HIBBS, Hohlmeißel .....	265	HOPKINS, Gipsmesser .....	233	Irisspatel, WECKER .....	378
HIBBS, Osteotome .....	265	HORGAN, Valve Bauchdeckenhalter .....	183	ISRAEL, Wundhaken .....	162
HIBBS, Wundhaken .....	164	HORIZON, Clipanlagezange .....	524, 525	ITERSON, Trachealhaken .....	477
HILL-FERGUSON, Rektal-Spekulum .....	560	Hornhautdissektor, GREEN .....	374, 375	IVES-FANSLER, Anuskop .....	562
Hirnmesser .....	48	Hornhautdissektor, PATON .....	373	IWANSON, Messgerät .....	624
Hirnspatel, CUSHING .....	336, 369	Hornhautmesser, ELSCHNIG .....	373		
Hirnspatel, DAVIS .....	337	Hornhautmesser, GILL .....	373	J	
Hirnspatel, HEIFETZ .....	369	Hornhautmesser, SATO .....	373	JACKSON-BURROWS, Bauchdeckenhalter .....	189/2
Hirnspatel, OLIVECRONA .....	336	Hornhautmesser, TOOK .....	373	JACKSON, Kehlkopfpinzette .....	471
Hirnspatelhalter, LEYLA .....	368/2	Hornhautschere, CASTROVIEJO .....	79	JACKSON, Laryngoskop .....	37
HIRSCHMANN, Anuskop .....	562	HORSLEY, Dura-Dissektor .....	333	JACKSON, Pinzette .....	471
HIRSCHMANN, Zyklodialysespatel .....	379	HOSEL, Wundhaken .....	167	JACKSON, Scheidenspekula .....	573

JACKSON, Sehnenfasszange .....	292	Kapselpinzette, CASTROVIEJO .....	391	KIRK, Hammer .....	270
JACKSON, Trachelhaken .....	476	Kapselpinzette, ELSCHNIG .....	391	KIRSCHNER, Bauchdeckenhalter .....	185, 187, 187/1
JACOBS, Hakenzange .....	583	Kapselpinzette, FUCHS .....	391	KIRSCHNER, Bohrdraht .....	306, 307
JACOBSON, Arterienklemme .....	105	Kapselpinzette, GILL-ARRUGA .....	390	KIRSCHNER, Extensionsbügel .....	312
JACOBSON, Dura-Haken .....	335	Kapselpinzette, HESS .....	391	KIRSCHNER, Führungshohlsonde .....	221
JACOBSON, Knopfsonde .....	335	Kapselpinzette, KALT .....	391	KIRSCHNER, Haken .....	185, 187
JACOBSON, Nadelhalter .....	215	Kapselpinzette, SCHWEIGGER .....	391	KIRSCHNER, Handbohrapparat .....	299
JACOBSON, scharfer Löffel .....	257	Kapselpinzette, TERSON .....	391	KIRSCHNER, Zughaken .....	313
JAEGER, Lanzenmesser .....	372	Kapselschere, RESANO .....	53/2	KIRSCHNER US, Extensionsbügel .....	312
JAEGER, Lidplatte .....	371	Kapselstanze, HOLTH .....	380	Klammeranlegezange, RANEY .....	327
JAMESON, Schielhaken .....	375	Katheter, COXETER .....	555	Klammerhalter .....	326
JAMESON, Strabismuspinzette .....	385	Katheter, Metall .....	555	KLAPP, Wundhaken .....	150
JANSEN, Hohlmeisselzange .....	237	Katheter, WALTHER .....	555	KLEINERT-KUTZ, Hauthäkchen .....	149
JANSEN, Nasenpinzette .....	424	Kathetereinführungsinstrument, GUYON .....	554	KLEINERT-KUTZ, Hohlmeissel .....	237
JANSEN, scharfer Löffel .....	257	Kathetereinführungzange, MAGILL .....	28	KLEINERT-KUTZ, Sehnenfassinstrument .....	294
JANSEN, Wundhaken .....	168	Katheterklemme, COOLEY .....	510	KLEINSASSER, Bruststütze .....	36
JANSEN-GRUENWALD, Nasenpinzette .....	424	KAYE, Face-Lift-Schere .....	73	KLEINSASSER, Fiberglas-Lichtträger .....	36
JARCHO, Hakenzange .....	583	Kegel, SCHULTZE Salpingograph .....	596	KLEINSASSER, Injektionskanüle .....	36
JAVID, Carotis-Shuntklemme .....	511	Kehldeckelhalter, REICHERT .....	471	KLEINSASSER, Rauchabsaugrohr .....	36
JENNINGS, Mundsperrler .....	454	Kehlkopfkanüle .....	470	KLEINSCHMIDT, Blinddarmklemme .....	544
JENSEN, Augenkanüle .....	394	Kehlkopfpinzette, JACKSON .....	471	Klemme, ALLEN .....	544
JOBSON-HORNE, Watteträger .....	203	Kehlkopfpolypenzange, FRAENKEL .....	471	Klemme, HAYES .....	545
JOHNS-HOPKINS, Anlegezange .....	104	Kehlkopfpolypenzange, JURASZ .....	471	Klemme, HOFFMANN .....	624
JOHNS-HOPKINS, Arterienklemme .....	120	Kehlkopfschere, KILLIAN .....	471	Klemme, KLEINSCHMIDT .....	544
JOHNS-HOPKINS, Bulldogklemme .....	104	Kehlkopfspiegel .....	473	Klemme, LANE .....	547
JOHNSON, Nadelhalter .....	211	Kehlkopfspiegel-Griff .....	473	Klemme, PAYR .....	548
JONES, Tuchklemme .....	132	Kehlkopfspiegel, MICHEL .....	423	Klemme, STOCKMANN .....	553/1
JONES-CLIP, Tuchklemme .....	132	Kehlkopfspritze .....	470	Klemme, STONE-WATT .....	545
JORGENSEN, Präparierschere .....	53	KEINSASSER, OP-Laryngoskop .....	35	Klemme, STRAUSS .....	553/1
JOSEF, Nasenmesser .....	434, 435	KEITH, Nadel .....	223	Klemme, Vasektomie .....	553/2
JOSEPH (LEWIS), Nasenraspel .....	443	KELLY, Anuskop .....	562, 563	Klemmenhalterung, DeMARTEL-WOLFSON .....	546
JOSEPH, Hauthäkchen .....	149	KELLY, Arterienklemme .....	106	Klemmenschießzange, DeMARTEL-WOLFSON .....	546
JOSEPH, Nasenmesser .....	434	KELLY, Gefäßschere .....	61	Klemmschloss, STONE-WATT .....	545
JOSEPH, Nasenraspel .....	443	KELLY, Proktoskop .....	563, 564	Klemmsockel .....	189
JOSEPH, Nasensäge .....	446	KELLY, Uterus-Polypenzange .....	585	Klinge .....	49
JOSEPH, Raspatör .....	277	KELLY, Wundhaken .....	164, 193	Klinge-Skalpell .....	42
JOSEPH, Schere .....	54/1	KELLY-GRIP, Wundhaken .....	142	Klingenbrecher, CASTROVIEJO .....	45
JOSEPH, Septumelelevator .....	437	KELLY-RANKIN, Arterienklemme .....	106	Klingenbrecher, REDA .....	45
JUDD-ALLIS, Darmfasszange .....	538	Keratoplastik-Messer, BARRAQUER .....	373	Klingenbrecher, TROUTMAN-CHRIS .....	45
JUDD-MASSON, Blasenwundspreizer .....	552	Keratoplastik-Messer PAUFIQUE .....	373	Klingenentferner .....	42
JUERS, Mikro-Ohrzängchen .....	414	KERN, Knochenhalte zange .....	244	KLINIKUM BERLIN, Schlauchklemme .....	129
JURASZ, Kehlkopfpolypenzange .....	471	KERRISON, Stanze .....	428	KLINIKUM BERLIN, Gefäßschere .....	65/2
		KERVORKIAN, Biopsiekürette .....	587	KNAPP, Irismesser .....	372
		KEVORKIAN, Uterus-Biopsiezange .....	589, 591	KNAPP, Irisschere .....	55
		KEVORKIAN-PACIFIC, Uterus-Biopsiezange .....	592	KNAPP, Starlöfl .....	378
<b>K</b>		KEY, Elevator .....	282	KNAPP, Tränensackhäkchen .....	375
Kabel, bipolar .....	633	KEYES, Trepbine .....	608	KNAPP-LUER, Trachompinzette .....	393
KABIERESKE, Pulverbläser .....	405	Kieferhöhlenstanze, HAJEK-KOFLER .....	429, 431	KNIGHT, Septumzange .....	425
KADER, Bauch- u. Darmspatel .....	143/3	Kieferhöhlenstanze, KERRISON .....	428	Knochendraht .....	314
KALLMORGEN, Halter .....	573	Kieferhöhlentroktr, COAKLEY .....	204	Knochenfeile .....	294, 612/1
KALLMORGEN, Scheidenspekula .....	573	Kieferhöhlentroktr, DOUGLAS .....	204	Knochenhaken, VOLKMANN .....	156
KALT, Kapselpinzette .....	391	Kieferhöhlentroktr, LICHTWITZ .....	204	Knochenhalteklammer, GERSTER .....	250
KALT, Nadelhalter .....	214	Kieferhöhlentroktr, PIERCE .....	204	Knochenhalteklammer, LAMBERT-LOWMAN .....	249
KALT-ARRUGA, Nadelhalter .....	214	KIELLAND, Geburtszange .....	602	Knochenhalteklammer, LOWMAN .....	249
Kaltlichtklammer .....	601	KIELLAND-LUIKART, Geburtszange .....	603	Knochenhalteklammer, LOWMAN-HOGLUND .....	249
Kaltlichtträger, HOLLINGER .....	37	KILLIAN, Hohlmeissel .....	442/1	Knochenhalte zange .....	245, 247, 249
Kaltlichtträger, JACKSON .....	37	KILLIAN, Nasenspekula .....	423	Knochenhalte zange, BIRCHER-GANSKE .....	246
KANE, Nabelschnurklemme .....	605	KILLIAN, Septumelelevator .....	438, 439	Knochenhalte zange, DINGMANN .....	246
KANTROWITZ, Arterienklemme .....	119/1	KILLIAN, Septumschere .....	471	Knochenhalte zange, FARABEUF .....	243
Kanüle, Air Injection .....	394	KILLIAN, Spülkanüle .....	433, 433/1	Knochenhalte zange, FARABEUF-LAMBOTTE .....	243
Kanüle, BISHOP-HARMON .....	394/1	KILLIAN-CLAUS, Septumhohlmeissel .....	442/1	Knochenhalte zange, FERGUSON .....	243
Kanüle, EICKEN (KILLIAN) .....	433	KILNER, Hauthäkchen .....	608	Knochenhalte zange, KERN .....	244
Kanüle, JENSEN .....	394	KILNER, Nadelhalter .....	212	Knochenhalte zange, LAMBOTTE .....	244
Kanüle, KILLIAN .....	433/1	KILNER, Nasenhaken .....	447/1	Knochenhalte zange, LANE .....	244
Kanüle, LACRIMAL .....	394	KILNER, Schere .....	54/1	Knochenhalte zange, LANGENBECK .....	243
Kanüle, McIntyre .....	394	KILNER, Supercuttschere .....	72	Knochenhalte zange, LEWIN .....	246
Kanüle, ROSEN .....	338	KILNER-DOUGHTY, Mundsperrler .....	456	Knochenhalte zange, MARTIN .....	246
Kanüle, Saugriff, ZÖLLNER u. WULLSTEIN .....	337/1	Kinder-Aortaklemme, SUBRAMANIAN .....	521	Knochenhalte zange, MEYER .....	248
Kanüle, SCHMID .....	338	Kinder-Aortaklemme, SUBRAMANIAN-MINITURE .....	521	Knochenhalte zange, PATELLA .....	248
Kanüle, SIMCOE .....	394/2	Kinder-Atrauma-Gefäßklemme .....	526, 527	Knochenhalte zange, REDA .....	246, 247
Kanüle, VERRES .....	206	Kinder-Gefäßklemme .....	527	Knochenhalte zange, REILL .....	248
Kanüle, WAGENER-MOSHER .....	477	Kinder-Gefäßklemme, COOLEY .....	522	Knochenhalte zange, SEMB .....	243
Kappenzange, REDA .....	615	KIRBY-ARTHUR, Fixierpinzette .....	385	Knochenhalte zange, ULRICH .....	248
Kapsel fasszange, MILLIN .....	550, 551				
Kapselpinzette, ARRUGA .....	391				

Knochenhaltezange, VAN BUREN .....	249	Kornzange, ULRICH .....	135	Laminektomie-Zange, DECKER .....	341
Knochenhaltezange, VERBRUGGE .....	245	KÖRTE, Bauch- u. Darmspatel .....	143/3	Laminektomie-Zange, FERRIS-SMITH .....	343
Knochenhebel .....	282 - 286/2, 288	Krampfaderbesteck, NABATOFF .....	201	Laminektomie-Zange, LANDOLT .....	341/2
Knochenhebel, AUFRANC-COBRA .....	289	Kranioclast, BRAUN .....	607	Laminektomie-Zange, LOVE-GRUENWALD .....	340
Knochenhebel, BENNETT .....	283	Kranioclast, TARNIER .....	607	Laminektomie-Zange, OLDBERG .....	341/1
Knochenhebel, BLOUNT .....	288	KRAUSE, Aufsatz .....	472	Laminektomie-Zange, PEAPOD .....	341/1
Knochenhebel, BRISTOW .....	290	KRAUSE, Polypenschnürer .....	411, 433/2	Laminektomie-Zange, SCHLESINGER .....	342
Knochenhebel, BUCK-GRAMCKO .....	285	KRAUSE-VOSS, Polypenschnürer .....	433/2	Laminektomie-Zange, SPURLING .....	340
Knochenhebel, HOHMANN .....	284, 285	KRAYENBÜHL, Nervhäkchen .....	336	Laminektomie-Zange, WAGNER .....	343
Knochenhebel, HOHMANN Mini .....	286	Kreuzschlitzschraubenzieher, LANE .....	324	LANCASTER, Lidsperner .....	371
Knochenhebel, KÖNIG .....	284	KRISTELLER, Halter .....	572	LANDAU, Scheidenspekula .....	577
Knochenhebel, LANE .....	290	KRISTELLER, Scheidenspekula .....	572	LANDOLT, Erukulationsschere .....	58
Knochenhebel, LANGE-HOHMANN .....	286	KROENIG, Zungenspatel .....	451	LANDOLT, Laminektomiezange .....	341/2
Knochenhebel, LANE-TRETHOWAN .....	290	KRONECKER, Unterbindungsnadel .....	219	LANDOLT, Tumorfasszange .....	341
Knochenhebel, MURPHY-LANE .....	283	Kronenschere, BEEBEE .....	68	LANE, Biegehebel .....	325
Knochenhebel, SMILLIE .....	291	Kropffasszange, LAHEY .....	479	LANE, Knochenhaltezange .....	244
Knochenhebel, TAYLOR .....	291	Kropfsonde, KOCHER .....	479	LANE, Knochenhebel .....	290
Knochenhebel, VERBRUGGE-MÜLLER .....	287	Kugelenkklöben, LEYLA .....	368/1	LANE, Knochenplatten-Haltezange .....	325
Knochen Nagel .....	309	KUGLEN, Hähchen .....	376	LANE, Kreuzschlitz-Schraubenzieher .....	324
Knochen Nagel, STEINMANN .....	307, 308	KÜMMEL, Bauch- u. Darmspatel .....	143/2	LANE, Magenquetschklemme .....	547
Knochenplattenhalte zange, LANE .....	325	KÜNTSCHER, Aufreiber .....	321	LANE, Pinzette .....	84
Knochenraspel .....	294	KÜNTSCHER, Extraktor .....	322	LANE, Schraubenhalte zange .....	325
Knochenraspel, PUTTI .....	294	KÜNTSCHER, Fertigschläger .....	321	LANE, Schraubenzieher .....	323
Knochen splitterzange, BÖHLER .....	241	KÜNTSCHER, Vorbohrer .....	321	LANE, Tuckklemme .....	133
Knochen splitterzange, COTTLE-KAZANJIAN .....	241	Kupplungskopf, LEYLA .....	368/1	LANE-TRETHOWAN, Knochenhebel .....	290
Knochen splitterzange, LISTON .....	241	Kürette .....	600, 612	LANG, Tränensack-Dissektor .....	378
Knochen splitterzange, McINDOE .....	241	Kürette, ANTRUM .....	435	LANGE, Aufsatz .....	472
Knochen splitterzange, RUSKIN-LISTON .....	241	Kürette, BLAKE .....	595	LANGE, Nasenflügelhähchen .....	448
Knochen splitterzange, SEMB .....	242	Kürette, BUMM .....	597	LANGE-HOHMANN, Knochenhebel .....	286
Knochen splitterzange, STAMM .....	241	Kürette, COAKLEY .....	449	LANGENBECK, Amputationsmesser .....	44
Knochen splitterzange, STILLE-HORSLEY .....	242	Kürette, COBB .....	252	LANGENBECK, Fingersäge .....	296
Knochen splitterzange, STILLE-LISTON .....	242	Kürette, FAULKNER .....	449	LANGENBECK, Fingerschützer .....	311
Knochenstanze, CITELLI .....	430	Kürette, FOX .....	608	LANGENBECK, Knochenhalte zange .....	243
Knochenstanze, OSTROEM .....	430	Kürette, GOURDET .....	599	LANGENBECK, Knorpelmesser .....	47
Knopfsonde .....	199	Kürette, HEANY .....	584	LANGENBECK, Nadelhalter .....	213
Knopfsonde, JACOBSON .....	335	Kürette, HEBRA .....	377	LANGENBECK, Ohrschlinge .....	409
Knorpelmesser, LANGENBECK .....	47	Kürette, HOUSE .....	420	LANGENBECK, Raspator .....	275
Knorpelquetscher, COTTLE .....	440	Kürette, KEVORKIAN .....	587	LANGENBECK, Wundhaken .....	158, 159
Knorpelschere, McINDOE .....	65/1	Kürette, MEYHOEFER .....	377	LANGENBECK-GREEN, Wundhaken .....	153
KNOWLES, Verbandschere .....	70	Kürette, MOD. MUENCHEN .....	587	Langenmesser, JAEGER .....	372
Koagulationselektrode .....	629	Kürette, NOVAK .....	587	Lärmtrommel, BARANY .....	405
KOCHER, Arterienklemme .....	108	Kürette, PIFFARD .....	608	LARSEN, Sehnerfasspinzette .....	292
KOCHER, Blasenpatel .....	552	Kürette, RANDALL .....	587	Laryngoskop, HOLINGER .....	37
KOCHER, Darmklemme .....	540	Kürette, RAY .....	334	Laryngoskop, JACKSON .....	37
KOCHER, Kropfsonde .....	479	Kürette, RECAMIER .....	597	Laryngoskop, MILLER .....	30
KOCHER, Wundhaken .....	155, 159, 160, 163	Kürette, SCHRÖDER .....	595	Laryngoskop-Kaltlichtgriff, Batteriegriff .....	33
KOCHER-LANGENBECK, Wundhaken .....	159	Kürette, SIMS .....	597	Laryngoskop-Warmlicht, Batteriegriff .....	32
KOENIG, Führungshohlsonde .....	221/1	Kürette, THOMAS .....	599	Laryngoskop-Warmlichtgriff, Trafo-Anschluss .....	34
KOENIG, Nadel .....	223			Lateralspreizer .....	569
KOERTE, Wundhaken .....	162	L		LAWRENCE, Arterienklemme .....	119
Koffer, Gips säge .....	230/18	LA FORCE, Fremdkörp ernadel .....	374	LEBSCHKE, Sternummeißel .....	267
KOGAN, Endospekula .....	577	LA FORCE, Ringmesser .....	450	LEES, Bronchusklemme .....	504
Komedonenquetscher, SAALFELD .....	608	LA GRANGE, Zahnfleischschere .....	69	LEGUE, Blasenwund spreizer .....	553
Komedonenquetscher, SCHAMBERG .....	608	LA GRANGE, Supercuttschere .....	72	LEGUEU, Blasenpatel .....	552
Komedonenquetscher, UNNA .....	608	LABORDE, Trachealdilatator .....	476	LEKSELL (STILLE), Hohlmeißelzange .....	240
Komedonenquetscher, WALTON .....	608	LACRIMAL, Augenkanüle .....	394	LELAND-JONES, Gefäßklemme .....	495
Kompressorium, FELDHEIM .....	249	Ladekonus, RUDD .....	568	LEMPERT, Elevator .....	420
Komprimeter .....	295	LAHEY, Arterienklemme .....	120	LEMPERT, Hohlmeißelzange .....	237
KÖNIG, Knochenhebel .....	284	LAHEY, Kropffasszange .....	479	LEMPERT, scharfer Löffel .....	256
KÖNIG, Raspator .....	276	LAHEY, Wundhaken .....	157	LERICHE, Fasspinzette .....	83
KÖNIG, Wundhaken .....	153	LAMBERT, Chalzionspinzette .....	393	LERICHE, Arterienklemme .....	111
KOOS, Duramesser .....	335	LAMBERT-KAY, Anastomosenklemme .....	505	LERICHE, Bauchspatel .....	143/2
Kopfhautklammer, RANEY .....	327	LAMBERT-LOWMAN, Knochenhalteklammer .....	249	LERICHE, Darmspatel .....	143/2
Kopfschwartenzange, GAUSS .....	605	LAMBOTTE, Knochenhalte zange .....	244	LESTER, Fixationspinzette .....	389
Kornzange .....	135	LAMBOTTE, Osteotom .....	261	LEVINSON, Fremdkörp ernadel .....	374
Kornzange, BRYANT .....	137	LAMBOTTE, Raspator .....	274	LEWIN, Knochenhalte zange .....	246
Kornzange, CHERON .....	137	Laminektomie-Spreizer, CHERRY .....	488	LEWIS, Nasenraspel .....	443
Kornzange, COLLIN .....	137	Laminektomie-Spreizer, CASPAR .....	179, 180	LEXER-BABY, Präparierschere .....	53
Kornzange, DUPLAY .....	134	Laminektomie-Spreizer, MEYERDING .....	180	LEXER, Flachmeißel .....	263
Kornzange, GROSS-MAIER .....	134	Laminektomie-Spreizer, SCOVILLE .....	196	LEXER, Hohlmeißel .....	263
Kornzange, MAIER .....	134	Laminektomie-Spreizer, SCOVILLE-HAVERFIELD .....	196	LEXER-Mini, Hohlmeißel .....	263
Kornzange, PELKMANN .....	137	Laminektomie-Zange, CLOWARD .....	342	LEXER, Präparierschere .....	53
Kornzange, SIMS-MAIER .....	134	Laminektomie-Zange, CUSHING .....	340	LEYLA, Fixiervorrichtung .....	368/1



LEYLA, Haltearm .....	368/4	LUCAE, Hackchen .....	409	MAXI-GRASPER, Uterus-Biopsiezange .....	593
LEYLA, Hirnsattelhalter .....	368	LUCAE, Hammer .....	271	MAY, Ophthalmoskop UNI II .....	14
LEYLA, Kugelgelenkkloben .....	368/4	LUCAE, Ohrpinzette .....	410	MAYFIELD, Hohlmehelzange .....	238
LEYLA, Kupplungskopf .....	368/4	LUCAE, Parazentese-Nadel .....	408	MAYO, Gallensteinloffel .....	534
LEYLA, Retraktor-System .....	368 - 368/4	LUCAE, Stimmgabel .....	404	MAYO, Gallensteinsonde .....	534
LICHTENBERG, Nadelhalter .....	213	LUER, Hohlmehelzange .....	236	MAYO, Pinzette .....	89
Lichtleiterkabel-Siebkorb .....	623	LUER, Trachealkanule .....	479	MAYO, Praparierschere .....	52/1
Lichttrager .....	37	LUER, Wundhaken .....	140	MAYO, Sterilisierklammer .....	227, 624
Lichttrager, JACKSON .....	37	LUER-KOERTE, Gallensteinloffel .....	533	MAYO, Supercuttschere .....	71
Lichttrager, HOLLINGER .....	37	Luftdusche, POLITZER .....	406	MAYO, Zungenspatel .....	451
LICHTWITZ, Kieferhohlentroker .....	204	Luftpumpe .....	295	MAYO-ADAMS, Wundspreizer .....	171
Lidplatte, JAEGER .....	371	LUJKART, Geburtszange .....	603	MAYO-BLAKE, Gallensteinzange .....	530/2
Lidsperrer, ARRUGA .....	370	LUJKART-BILL, Zughebel .....	604	MAYO-COLLINS, Wundhaken .....	141
Lidsperrer, BARRAQUER .....	370	Lungenfasszange, LOVELACE .....	490	MAYO-GUYON, Arterienklemme .....	122
Lidsperrer, BOWMAN .....	370	Lungenschere, CRAFOORD .....	65/2	MAYO-HABERISSER, Drahtzange .....	319
Lidsperrer, CASTROVIEJO .....	371	Lungenspatel .....	489/2	MAYO-HEGAR, Nadelhalter .....	209
Lidsperrer, CLARK .....	370	Lungenspatel, ALLISON .....	489/2	MAYO-NOBLE, Praparierschere .....	52/1
Lidsperrer, CRITCHETT .....	370	LUNSGAARD, Sklerotom .....	373	MAYO-ROBSON, Darmklemme .....	541
Lidsperrer, GRAEFE .....	370	LUINIATSCHEK, Tamponstopfper .....	465	MAYO-STILLE, Praparierschere .....	52/1
Lidsperrer, LANCASTER .....	371	Lupuskurrette, FOX .....	608	MAYO-STILLE, Supercuttschere .....	71
Lidsperrer, LIEBERMAN .....	371	Lupuskurrette, PIFFARD .....	608	McDONALD, Elevator .....	283
Lidsperrer, LISTER-BURCH .....	370	M		McCULLOUGH, Strabismuspinzette .....	385
Lidsperrer, MELLINGER .....	370	Magen-Darmnahapparat, PETZ .....	549	McGEE, Hackchen .....	419
Lidsperrer, MELLINGER-AXENFELD .....	370	Magen-Darmklemme, LANE .....	547	McGEE, Mikro-Ohrzangchen .....	414
Lidsperrer, MUELLER .....	371	Magen-Darmklemme, MIKULICZ .....	547	McGIVNEY, Hamorrhoidal-Ligator .....	568
Lidsperrer, MURDOCK .....	370	Magen-Darmklemme, PAYR .....	548	McGIVNEY, Hamorrhoidal-Zange .....	568
Lidsperrer, PARK .....	371	Magen-Darmklemme, RUMEL .....	528	McINDOE, Knochen splitterzange .....	241
Lidsperrer, SMITH .....	370	MALGILL, Kathetereinfuhrzange .....	28	McINDOE, Knorpelschere .....	65/1
Lidsperrer, STEVENSON .....	371	MAIER, Kornzange .....	134	McINDOE, Pinzette .....	85
Lidsperrer, WEEK .....	370	MALNGOT, Hysterektomieklammer .....	123/1, 123/2	McINTYRE, Augenkanule .....	394
Lidsperrer, WILLIAMS .....	370	MALTZ (COTTLE), Nasenraspel .....	444	McIVOR, Mundsperrerr .....	457
Lidsperrer, ZIEGLER .....	371	MALTZ, Nasenraspel .....	443	McKENTY, Septum elevator .....	437, 438
LIEBERMAN, Lidsperrer .....	371	Mammaria, Sternum-Sperrerr .....	487/1	McKENZIE, Anlegezange .....	326
Lidgur-Gummiringe, McGIVNEY .....	568	Mandrin, RUMEL-BELMONT .....	528	McKENZIE, Bohrer .....	299
Ligaturklemme, DeBAKEY .....	499, 500	Manometer .....	295	McLEAN, Geburtszange .....	603/1
Ligaturklemme, DeBAKEY-RUMEL .....	499	Manometer, SCHULTZE .....	596	McLEAN-LUIKART, Geburtszange .....	603/1
Ligaturschere .....	54	MAGIN, Elevator .....	380	McLEAN-TUCKER, Geburtszange .....	603/1
Linsen haken, STEVENS .....	375	Markierungsinstrument, CONNIN-AMSLER .....	380	McLEAN-TUCKER-LUIKART, Geburtszange .....	603/1
Linsenmanipulator, BECHERT .....	379	Markraumborherr .....	322	McPHERSON, Fadenpinzette .....	392
Lippenhalter .....	453, 451	MARQUARD, Hohlmehelzange .....	239	MEAD, Hammer .....	271
Lippenhalter, CAWOOD-MINNESOTA .....	451	MARSSCHIK, Tonsillenfasspinzette .....	468	MEAD, Hohlmehelzange .....	235
LISTER (SINUS) Tupferzange .....	137	MARTEL, Fasszange .....	110	Medizinbecher .....	621
LISTER, Supercuttschere .....	72	MARTIN, Beckenzirkel .....	605	Medizinloffel .....	268, 621
LISTER, Verbandschere .....	69/1	MARTIN, Cartilageschere .....	65/1	MEEKER, Arterienklemme .....	119
LISTER-BURCH, Lidsperrer .....	370	MARTIN, Knochenhalte zange .....	246	MEHDORN, Anlegepinzette .....	362
LISTON, Amputationsmesser .....	44	MARTIN, Uterussonde .....	586	MEHDORN, Gefassclip .....	362
LITTON, Knochen splitterzange .....	241	MARTIN, Verbindungskabel .....	633	Mehr zwick-Gefassklemme .....	520
LITTAUER, Cilienpinzette .....	395	MARTIN, Wundspreizer .....	175/1	Mehr zwick-Gefassklemme, BAINBRIDGE .....	495/1, 495/2
LITTAUER, Fadenschere .....	66	MARTINI, scharfer Loffel .....	257	Mehr zwick-Gefassklemme, COOLEY .....	518 - 520
LITTAUER, Ohrzangchen .....	411	MASING, Elevator .....	437	Mehr zwick-Gefassklemme, GLOVER .....	515
LITTAUER, Polypenzange .....	425	MASING, Nasenhaken .....	447	Mehr zwick-Gefassklemme, DeBAKEY .....	495, 508, 514 - 517
LITTLE, Wundhaken .....	157	MASSON, Nadelhalter .....	210	Mehr zwick schale .....	620
LITTLER, Irisschere .....	55	Maband .....	25	Meissel, BRUNETTI .....	268
LITTLEWOOD, Darmfasszange .....	538	Mastab, Metall .....	25	Meissel, CINELLI .....	441
LOCKHART-MUMMERY, Fistelsonde .....	200	Mastdarm-Biopsiezange, TURREL .....	567	Meissel, FREER .....	442/1
LOCKLIN, Zahnfleischschere .....	69	Mastdarm-Biopsiezange, YEOMAN .....	566, 567	Meissel, HAJEK .....	442/1
LOCKWOOD-ALLIS, Darmfasszange .....	538	Mastdarm-Spekula, ALAN-PARKS .....	561	Meissel, KILLIAN .....	442/1
Loffelzangchen .....	416	Mastdarm-Spekula, BARR .....	559	Meissel, KILLIAN-CLAUS .....	442/1
LONDON-COLLEGE, Zahnpinzette .....	93	Mastdarm-Spekula, BODENHAMMER .....	559	Meissel, SILVER .....	442
LOPEZ-REINKE, Tonsillen-Dissektor .....	465	Mastdarm-Spekula, CZERNY .....	559	Meissel, WEST .....	442/1
LORENZ, Verbandschere .....	70	Mastdarm-Spekula, MATHIEU .....	560	Meisselklinge .....	266
LORNA, Tuchklemme .....	133	Mastdarm-Spekula, PRATT .....	559	MELLINGER, Lidsperrer .....	370
LOUTE, Drahtspanninstrument .....	315	Mastdarm-Spekula, SIMS .....	559	MELLINGER-AXENFELD, Lidsperrer .....	370
LOVE, Nervwurzelhaken .....	329/2, 330	Mastdarm-Spekula, SCHULZE-BERGMANN .....	560	MENGHINI, Biopsiekanule .....	206
LOVE, Wundhaken .....	465	MASTIN, Muskelklemme .....	479	Meniskushaken, BLOUNT .....	289
LOVE-GRUENWALD, Laminektomie zange .....	340	MATHIEU, Fremdkorperzange .....	553/1	Meniskusmesser, NEFF .....	292
LOVELACE, Arterienklemme .....	109	MATHIEU, Mastdarmspekula .....	560	Meniskusmesser, SMILLIE .....	292
LOVELACE, Lungenfasszange .....	490	MATHIEU, Nadelhalter .....	213	MERCEDES, Thoraxsperrerr .....	489
LOWER, Arterienklemme .....	120	MATHIEU, Wundhaken .....	141	MERIAM, Zahnpinzette .....	93
LOWMAN, Knochenhalteklammer .....	249	MATHIEU-OLSEN, Nadelhalter .....	212	Messebecher .....	620
LOWMAN-HOGLUND, Knochenhalteklammer .....	249	MATSON, Raspator .....	279	Messer, Amputation .....	44
LUBET-BARBON, Nasentamponzange .....	424	MATSON-ALEXANDER, Raspator .....	279	Messer, BARKAN .....	373
LUC, Septumzange .....	426	MAUNDER, Mundkeil .....	459	Messer, BARRAQUER .....	373

Messer, BERENS.....	372
Messer, CASTROVIEJO.....	372
Messer, CONVERSE.....	435
Messer, COTTLE.....	435
Messer, DEAN.....	372
Messer, FREER.....	434
Messer, GRAFE.....	372
Messer, JAEGER.....	372
Messer, JOSEPH.....	434, 435
Messer, KNAPP.....	372
Messer, PAUFIQUE.....	373
Messer, PLESTER.....	418
Messer, POLITZER.....	408
Messer, REDA.....	435
Messer, ROSEN.....	418
Messer, SCHEIE.....	373
Messer, SCHUKNECHT.....	418
Messer, SEXTON.....	408
Messer, TABB.....	418
Messer, WHEELER.....	373
Messer, WULLSTEIN.....	418
Messer, ZIEGLER.....	372, 373
Messer, Zwischenknochen.....	44
Messgerät, IWANSON.....	624
Messinstrumente.....	594
Messschieber.....	26
Messsonde, HOUSE.....	420
Messzirkel, CASTROVIEJO.....	380
Metalkatheter.....	555
Metalkatheter, COXETER.....	555
METZENBAUM, Nadelhalter.....	211
METZENBAUM, Präparierschere.....	53 - 54
METZENBAUM, Supercutschere.....	71
MEYER, Knochenhaltezange.....	248
MEYERDING, Laminektomiespreizer.....	180
MEYERDING, Wundhaken.....	157, 177
MEYERDING, Wundspreizer.....	180
MEYHOEFER, Chalzionskürette.....	377
MICHEL, Kehlkopfspiegel.....	423
MICHEL, Wundklammern.....	224
MICHEL, Wundklammerpinzette.....	224
MICHEL, Wundklammerzange.....	224
Micro-FRIEDMANN, Hohlmeisselzange.....	234
Micro-HARTMANN, Arterienklemme.....	104
MICROVASCULAR, Nadelhalter.....	210
MIDDELDORF, Wundhaken.....	160
MIDDLETON-JANSEN, Septumzange.....	430
Mikro-chirurgische Pinzette.....	94
Mikro-chirurgische Pinzette, GOMEL.....	96
Mikro-Fasszängchen, Rohrschaft.....	415
Mikro-Kantüle, ZÖLLNER u. WULLSTEIN Sauggriff.....	337/1
Mikro-Löffelzängchen, Rohrschaft.....	416
Mikro-Löffelzängchen, WULLSTEIN.....	416
Mikro-Messsonde, HOUSE.....	420
Mikro-Ohrscheren, BELLUCCI.....	413, 417
Mikro-Ohrscheren, SHEA.....	413
Mikro-Ohrzängchen.....	413 - 416
Mikro-Ohrzängchen, COS.....	414
Mikro-Ohrzängchen, DIETER.....	414
Mikro-Ohrzängchen, GREVEN.....	414
Mikro-Ohrzängchen, HAUGH.....	414
Mikro-Ohrzängchen, JUERS.....	414
Mikro-Ohrzängchen, McGEE.....	414
Mikro-Rohrschaftzange REDA.....	474
Mikro-Schere, GOMEL.....	80
Mikro-Schere, HEPP-SCHUIDEL.....	78
MIKULICZ, Darmklemme.....	543
MIKULICZ, Peritoneumklemme.....	123
MIKULICZ, Wundhaken.....	163
MIKULICZ-BABY, Peritoneumklemme.....	123
MILLER, Laryngoskop.....	30
MILLER, Nasenraspel.....	444
MILLIGAN, Dura-Dissektor.....	332

MILLIN, Blasenperrerr.....	552, 553
MILLIN, Kapselasspinzette.....	550, 551
MILLIN, Prostatafasszange.....	550, 551
Mini-Bulldogklemme, DeBAKEY-DIETRICH.....	101
Mini-Bulldogklemme, DIETRICH.....	101
Mini-Schnellkupplungshandgriff.....	301
Mini-Skalpell.....	41
Mini-Skalpellgriffe.....	41
MINI-LAMBOTTE, Flachmeissel.....	262
MINI-TOWNSEND-DOWN, Biopsiezange.....	591
MINI-TOWNSEND-UP, Biopsiezange.....	591
MIXTER, Arterienklemme.....	116
MIXTER, Gallensteinzange.....	530/2
MIXTER-BABY, Arterienklemme.....	119/1
MIXTER-DeBAKEY, Gefäßsklemme.....	499/2
MIXTER-O-SHAUGNESSY, Arterienklemme.....	119/2
Mobilisierhaken, TESSIER.....	463/3
MOD, BONN, Nahtpinzette.....	387
MOD, TÜBINGEN, Fadenpinzette.....	392
MOD, TÜBINGEN, Nahtpinzette.....	387
MOD, MÜNCHEN, Biopsiekürette.....	587
MOD, VIENNA, Nasenspekula.....	421
MOELTGEN, Winkelmesser.....	25
MOGEN, Beschneidungsgerät.....	556
MOLLISON, Wundspreizer.....	171
MOLT, Raspatorium.....	276
Monopolare Elektrode.....	629
Monopolare Pinzette.....	634
MOOR, Gallensteinlöffel.....	531
MOORE, Handbohrapparat.....	298
MOORFIELD, Nahtpinzette.....	392
MORGAN, Proktoskop.....	565
MORITZ-SCHMIDT, Zungenspatel.....	452
MORRIS, Wundhaken.....	164
MORRIS-DeBAKEY, Aortaklemme.....	506
MORSE, Rippensperrer.....	484
MORSE-FAVALORO, Rippensperrer.....	484
Motorfilter.....	231/1
MOYNIHAN, Arterienklemme.....	120
MOYNIHAN, Gallensteinsonde.....	531
MOYNIHAN, Tuchklemme.....	133
Mukosamesser, FREER.....	434
MÜLLER, Approximator.....	364
MÜLLER, Gefäßscilip.....	365
MUELLER, Lidsperrerr.....	371
Mundkeil, MAUNDER.....	459
Mundsperrerr, DAVIS-BOYLE.....	455
Mundsperrerr, DAVIS-MEYER.....	457
Mundsperrerr, DENHART.....	454
Mundsperrerr, DINGMANN.....	456
Mundsperrerr, DOYEN-JANSEN (MOLT).....	454
Mundsperrerr, HEISTER.....	454
Mundsperrerr, JENNINGS.....	454
Mundsperrerr, KILNER-DOUGHTY.....	456
Mundsperrerr, McIVOR.....	457
Mundsperrerr, ROSER-KOENIG.....	454
MURDOCK, Lidsperrerr.....	370
MURPHY, Wundhaken.....	156
MURPHY-LANE, Elevator.....	283
MUSEUX, Hakenzange.....	583
Muskelhaken.....	267
Muskelklemme, MASTIN.....	479
Muskelpinzette, BERKE.....	389
Muskelpinzette, PRINCE.....	387
Muskelpinzette, SNELLEN.....	393
Muskelpinzette, TROUTMAN.....	389
Mutterschlüssel.....	313
MYLES, Nasenzange.....	427
Myomheber, DOYEN.....	594
Myommesser, SEGOND.....	594
Myrtenblattsonde.....	199

N	
NABATOFF, Krampfadertest.....	201
Nabelschnurklemme, COLLIN.....	605
Nabelschnurklemme, KANE.....	605
Nabelschnurschere, BUSCH.....	64
Nabelschnurschere, MOD. USA.....	64
Nabelschnurschere, SCHUMACHER.....	64
Nadel, BARBARA.....	419
Nadel, chirurgisch.....	222
Nadel, REVERDIN.....	220
Nadel, ROSEN.....	419
Nadel, YOUNG-BOOMERANG.....	220
Nadeldose.....	615
Nadelelektrode, monopolar.....	628, 629
Nadelführer, IOWA.....	206
Nadelhalter, ADSON.....	211
Nadelhalter, ARRUGA.....	214
Nadelhalter, BABY-OLSEN-HEGAR.....	212
Nadelhalter, BABY-WEBSTER.....	208
Nadelhalter, BARRAQUER.....	216, 217
Nadelhalter, BARRAQUER-TROUTMAN.....	216
Nadelhalter, BAUMGARTNER.....	208
Nadelhalter, BOYNTON.....	214
Nadelhalter, BOZEMANN.....	211
Nadelhalter, BROWN.....	209
Nadelhalter, CASTROVIEJO.....	215, 216
Nadelhalter, COLLIER.....	208
Nadelhalter, CRILE.....	213
Nadelhalter, CRILE-MURRAY.....	209
Nadelhalter, CRILE-WOOD.....	209
Nadelhalter, DeBAKEY.....	210
Nadelhalter, DERF.....	208
Nadelhalter, FINOCHIETTO.....	211
Nadelhalter, GILLIES.....	212
Nadelhalter, HALSEY.....	208
Nadelhalter, HEANEY.....	210
Nadelhalter, HOESEL.....	213
Nadelhalter, JACOBSEN.....	215
Nadelhalter, JOHNSON.....	211
Nadelhalter, KALT.....	214
Nadelhalter, KALT-ARRUGA.....	214
Nadelhalter, KILNER.....	212
Nadelhalter, LANGENBECK.....	213
Nadelhalter, LICHTENBERG.....	213
Nadelhalter, MASSON.....	210
Nadelhalter, MATHIEU.....	213
Nadelhalter, MATHIEU-OLSEN.....	212
Nadelhalter, MAYO-HEGAR.....	209
Nadelhalter, METZENBAUM.....	211
Nadelhalter, MICROVASCULAR.....	210
Nadelhalter, NEIVERT.....	208
Nadelhalter, OLSEN-HEGAR.....	212
Nadelhalter, RYDER.....	210
Nadelhalter, SAROT.....	211
Nadelhalter, STEVENS.....	214
Nadelhalter, STRATTE.....	212
Nadelhalter, WANGENSTEEN.....	210
Nadelhalter, WEBSTER.....	208
Nadelkasten.....	615
NAEGELE, Geburtszange.....	603
Nagelausreisszange, RADOLF.....	297
Nageldoppelfeile.....	612/1
Nagelfeile.....	610
Nagelhaltzange.....	610, 613
Nagelinstrument, INGROWN.....	612/1
Nagelschere.....	609, 610, 614
Nagel-Set.....	609
Nagelsplittinstrument.....	612/1
Nagelzange.....	609, 612/2, 613, 614
Nagelzange, ANVIL.....	613
Nagelzange, TURNBULL.....	609
NAGER, Tonsillennadel.....	466
NAGER, Wundhaken.....	465

Nahtbesteck.....	226	Nervhaken, ADSON.....	329	Ohrspekula, HARTMANN.....	399
Nahtpinzette, CASTROVIEJO.....	392	Nervhaken, CRILE.....	328	Ohrspekula, POLITZER.....	399
Nahtpinzette, MOD. BONN.....	387	Nervhaken, CUSHING.....	328	Ohrspekula, RICHAU-HOLMGREN.....	400
Nahtpinzette, MOD. TUEBINGEN.....	387	Nervhaken, DANDY.....	328	Ohrspekula, SIEGLE.....	402
Nahtpinzette, MOORFIELD.....	392	Nervhaken, D'ERRICO.....	329/2	Ohrspekula, TOYNBEE.....	399
Nahtpinzette, St. MARTIN.....	392	Nervhaken, DeMARTEL.....	330	Ohrspekulahalter, LEYLA.....	368/3
Nasenflügelhäkchen, LANGE.....	448	Nervhaken, GRAHAM.....	329	Ohrspritze, REINER.....	406
Nasenhaken, AUFRICHT.....	447	Nervhaken, HESS.....	329/1	Ohrzängchen.....	413 - 416
Nasenhaken, CONVERSE.....	448	Nervhaken, HOLSHER.....	329/1	Ohrzängchen, COS.....	414
Nasenhaken, COTTLE.....	447/1, 447	Nervhaken, LOVE.....	329/2, 330	Ohrzängchen, GREVEN.....	414
Nasenhaken, FOMON.....	447/1	Nervhaken, SACHS.....	329	Ohrzängchen, HARTMANN.....	411, 412, 424
Nasenhaken, KILLNER.....	447/1	Nervhaken, SCOVILLE.....	329/1, 330	Ohrzängchen, HARTMANN-HOFFMANN.....	412
Nasenhaken, MASING.....	447	Nervhaken, SMITHWICK.....	329	Ohrzängchen, HARTMANN-WULLSTEIN.....	412
Nasenhaken, MASING-NEVERT.....	447	Nervhaken, YASARGIL.....	330	Ohrzängchen, HAUGH.....	414
Nasenmeißel, WEST.....	442/1	Nervrädchen, WARTENBERG.....	25	Ohrzängchen, HEYMANN-KNIGHT.....	425
Nasennmesser, CONVERSE.....	435	Nervwurzelhaken, D'ERRICO.....	329/2	Ohrzängchen, JUERS.....	414
Nasennmesser, COTTLE.....	435	Nervwurzelhaken, HESS.....	329/1	Ohrzängchen, LITTAUER.....	411, 425
Nasennmesser, FREER.....	434	Nervwurzelhaken, LOVE.....	329/2, 330	Ohrzängchen, LUBET-BARBON.....	424
Nasennmesser, JOSEPH.....	434, 435	Nervwurzelhaken, SCOVILLE.....	329/1, 330	Ohrzängchen, McGEE.....	414
Nasenuolive, POLITZER.....	406	Neuro-chirurgische Schere.....	65	Ohrzängchen, NOYES.....	425
Nasenpinzette, JANSEN.....	424	Neuro-chirurgische Schere, STRULLY.....	65	Ohrzängchen, STRUEMPEL.....	412
Nasenpinzette, JANSEN-GRUENWALD.....	424	NEWS, Trachealhaken.....	477	Ohrzängchen, TILLEY.....	411
Nasenpinzette, TROELTSCH.....	424	Nierenklemme, GUYON.....	122	Ohrzängchen, WESTMACOTT.....	424
Nasensraspel, AUFRICHT.....	443	Nierenschale.....	619	Ohrzängchen, WULLSTEIN.....	416
Nasensraspel, FOMON.....	444	Nierensteinklemme, HERRICK.....	123	OLDBERG, Laminektomie-Zange.....	341/1
Nasensraspel, JOSEPH.....	443	Nierensteinzange, HEIMING.....	536	OLIVECRONA, Drahtsäge.....	332
Nasensraspel, JOSEPH (LEWIS).....	443	Nierensteinzange, RANDALL.....	535	OLIVECRONA, Dura-Dissektor.....	332
Nasensraspel, LEWIS.....	443	Nierenstiellklemme, WERTHEIM-CULLEN.....	125	OLIVECRONA, Hirnspatel.....	336
Nasensraspel, MALTZ.....	443	NISSEN, Arterienklemme.....	113	OLIVECRONA, Hohlmeißelzange.....	237
Nasensraspel, MALTZ (COTTLE).....	444	NORFOLK/NORWICH, Wundspreizer.....	172	OLIVECRONA-TOENNIS, Anlegezange.....	326
Nasensraspel, MILLER.....	444	NORTHBENT, Fadenschere.....	66	OLLIER, Wundhaken.....	162
Nasensraspel, PEET.....	446	NOTO, Uterus-Polypenzange.....	585	OLSEN-HEGAR, Nadelhalter.....	212
Nasensraspel, WIENER.....	443	NOVAK, Biopsiekürette.....	587	OMBREDANNE, Hammer.....	273
Nasensäge, JOSEPH.....	446	NOVOTEX, Hohlmeißel.....	264	Ophtalmologie-Schere, AEBLI.....	58
Nasenschere.....	429	NOYES, Augenschere.....	75	Ophtalmologie-Schere, GRADLE.....	57
Nasenschere, COTTLE.....	59	NOYES, Polypenzange.....	425	Ophtalmologie-Schere, STEVENS.....	58
Nasenschere, FOMON.....	58	Nystagmusbrille, FRENZEL.....	20	Ophtalmoskop, MAY UNI II.....	14
Nasenschere, HEYMANN.....	58			OP-Laryngoskop, HOLINGER.....	37
Nasenspekula, COTTLE.....	423	O		OP-Laryngoskop, JACKSON.....	37
Nasenspekula, HARTMANN.....	422	Obduktions-Besteck.....	269	OP-Laryngoskop, KLEINSASSER.....	35
Nasenspekula, HARTMANN-HALLE.....	421	Oberarmmanschette.....	295	Organmesser.....	48
Nasenspekula, KILLIAN.....	423	Oberschenkelmanschette.....	295	Organ- und Gewebefäßzange, atrauma.....	111
Nasenspekula, MOD. VIENNA.....	421	OBWEGESER, Ahle.....	463, 463/3	oszillierende Gipszange.....	230/10, 230/12
Nasenspekula, REDA.....	423	OBWEGESER, Blattosteotom.....	464/1	oszillierende Gipszange m. Stababsauger.....	231
Nasenspekula, THUDICHUM.....	421	OBWEGESER, Elevator.....	461/1	Osteotom.....	259, 464
Nasenspekula, TIECK-HALLE.....	423	OBWEGESER, Osteotom.....	463, 464/1	Osteotom, COTTLE.....	440
Nasenspekula, VOLTOLINI.....	421	OBWEGESER, Raspator.....	462	Osteotom, EPKER.....	464/2
Nasentamponzange, LUBET-BARBON.....	424	OBWEGESER, Wundhaken.....	460, 461/1	Osteotom, FOMON.....	441
Nasentamponzange, WESTMACOTT.....	424	OCHSNER, Trokar.....	205	Osteotom, HIBBS.....	265
Nasenzange.....	431	O'CONNOR, Iriskäkchen.....	375	Osteotom, HOKE.....	265
Nasenzange, CAPLAN.....	428	OEHLER, chirurgische Pinzette.....	81/1	Osteotom, LAMBOTTE.....	261
Nasenzange, GRAIG.....	426	Ohrhebel, ZAUFAL.....	409	Osteotom, LEXER.....	263
Nasenzange, HARTMANN.....	427	Ohrhebel, ZAUFAL-JANSEN.....	409	Osteotom, MINI-LAMBOTTE.....	262
Nasenzange, MIDDLETON-JANSEN.....	430	Ohrkatheter, HARTMANN.....	408	Osteotom, NEVERT-ANDERSON.....	442
Nasenzange, MYLES.....	427	Ohrkürette, BUCK.....	407	Osteotom, OBWEGESER.....	463, 464/1
Nasenzange, RUBIN.....	428	Ohrküffel, GROSS.....	409	Osteotom, RUBIN.....	440
Nasenzange, SCHMEDEN.....	427	Ohrmesser, POLITZER.....	408	Osteotom, SHEEHAN.....	441
Nasenzange, STRUYCKEN.....	427	Ohrmesser, SEXTON.....	408	Osteotom, SMITH-PETERSEN.....	261
Nasenzange, TAKAHASHI.....	427	Ohrpinzette, JANSEN.....	424	Osteotom, STILLE.....	260
Nasenzange, WATSON-WILLIAMS.....	428	Ohrpinzette, JANSEN-GRUENWALD.....	424	Osteotom, WEST.....	442/1
Nasenzange, WEIL-BLAKESLEY.....	426	Ohrpinzette, LUCAE.....	410	Osteotomklinge.....	266
NEFF, Meniskusmesser.....	292	Ohrpinzette, TROELTSCH.....	410, 424	OSTROEM, Knochenstanze.....	430
NEGUS, Bruststütze.....	459	Ohrpinzette, WILDE (TROELTSCH).....	410	O'SULLIVAN-O'CONNOR, Bauchdeckenhalter.....	181
NEGUS, Tonsillenzange.....	467	Ohrschlinge, BILLEAU.....	409	O'SULLIVAN-O'CONNOR, Scheidenspekula.....	576
NEVERT, Nadelhalter.....	208	Ohrscherchen, BELLUCCI.....	413	Oszillierende Gipszange.....	230/10, 230/12
NEVERT-ANDERSON, Septummeißel.....	442	Ohrscherchen, SHEA.....	413	OTIS, Urethrotom.....	553
NELATON, Hohlsonde.....	199	Ohrscherchen, WULLSTEIN.....	417	Otoskop Diagnostik-Besteck, UNI I.....	13
NELSON, Gefäßspinzette.....	89	Ohrschlinge, LANGENBECK.....	409	OVERHOLT, Arterienklemme.....	114
NELSON, Trokar.....	205	Ohrschlinge, SHAPLEIGH.....	410	OVERHOLT-BABY, Arterienklemme.....	114
NELSON, Unterbindungsnadel.....	219	Ohrsonde, STACKE.....	199	OVERHOLT-GEISENDOERFER, Arterienklemme.....	114
NEONATAL, Atraumaklemme.....	523	Ohrspekula, BOUCHERON.....	399	OVERHOLT-MIXTER, Arterienklemme.....	115
Neonatal-Gefäßklemme, CASTANEDA.....	527	Ohrspekula, BRUENINGS.....	401		
Nervhäkchen, KRAYENBUEHL.....	336	Ohrspekula, GRUBER.....	399		



P	Pinzette, BISHOP-HARMAN .....	85	Pinzette, STILLE-BARRAYA .....	88	
PALMER-POZZI, Hakenzange.....	582	Pinzette, BONACCOLTO .....	385	Pinzette, St. MARTIN.....	392
Parametriummklemme, REDA .....	128/1	Pinzette, BONNEY .....	88	Pinzette, STRASSBURGER MODELL .....	89
Parametriumschere TC.....	63	Pinzette, BROPHY .....	84	Pinzette, TAYLOR .....	87
Parazentesenadel, LUCAE .....	408	Pinzette, BROWN .....	83	Pinzette, TERSON .....	391
Parazentesenadel, POLITZER .....	408	Pinzette, CARMALT .....	91	Pinzette, TROELTSCH .....	424
PARK, Lidsperre .....	371	Pinzette, CASTROVIEJO .....	390 - 392	Pinzette, TROUTMAN .....	389
PARKER, Wundhaken .....	139	Pinzette, COLLIN-DUVAL .....	85	Pinzette, Tumor.....	97
PARKER-LANGENBECK, Wundhaken.....	141	Pinzette, COTTLE .....	410	Pinzette, Uhrmacher.....	90
PARTSCH, Flachmeißel .....	259	Pinzette, CUSHING .....	83	Pinzette, Ultra-light .....	95
PARTSCH, Hammer .....	271	Pinzette, CUSHING-TAYLOR .....	87	Pinzette, USA .....	81/1
PARTSCH, Hohlmeißel.....	259	Pinzette, DASTOOR .....	386	Pinzette, WAGENSTEEN .....	89
PASSOW, Blutstillungsmeißel .....	260	Pinzette, DAVIS .....	227	Pinzette, WAUGH .....	83
PATELLA, Knochenhaltezange .....	248	Pinzette, DeBAKEY .....	98, 99	Pinzette, WILDE (TROELTSCH).....	410
PATON, Hornhautdissektor .....	373	Pinzette, DESMARRÉS.....	393	Pinzette, YASARGIL .....	97
PAUFIQUE, Fadenpinzette .....	392	Pinzette, DOUGLAS .....	395	PIPER, Geburtszange .....	604
PAUFIQUE, Keratoplastik-Messer .....	373	Pinzette, DUEHRSEN .....	84	Pistole f. Reinigung .....	626
PAYR, Darmquetschklemme .....	548	Pinzette, DURANTE .....	88	Plastik-Hammer .....	271
PAYR, Führungshohlsonde .....	221/1	Pinzette, DUVAL .....	85	Plazentabecken .....	621/1
PAYR-BABY, Darmquetschklemme .....	548	Pinzette, ELSCHNIG .....	389, 391	PLESTER, Messer .....	418
PEAN, Arterienklemme .....	108, 110	Pinzette, FEILCHENFELD .....	91	PLESTER, Saugrohr .....	338
PEAPOD, Rongeur .....	341/1	Pinzette, FERRIS-SMITH .....	85	PLESTER, Wundspreizer .....	171
PECK-JOSEPH Präparierschere .....	74	Pinzette, FISCHER .....	384	POLITZER, Gummibirne .....	406
PEDERSON, Scheidenspekula .....	570	Pinzette, FOERSTER .....	383	POLITZER, Luftdusche .....	406
PENFIELD, Dissektor.....	333	Pinzette, FUCHS .....	391	POLITZER, Nasenolive .....	406
PEERS, Tuckklemme.....	132	Pinzette, GERALD .....	85, 86	POLITZER, Ohrmesser .....	408
PEET, Nasenraspel .....	446	Pinzette, GILL .....	384	POLITZER, Ohrspekula .....	399
PEET, Splitterzange .....	92	Pinzette, GILL-ARRUGA .....	390	POLITZER, Parazentesse-Nadel .....	408
PELKMANN, Tupferzange .....	137	Pinzette, GILL-HESS .....	384	Polster f. Oberarm- u. Oberschenkelmanschette .....	295
Pelvis-Haken, St. MARKS .....	165	Pinzette, GILLIES .....	86	Polypenschlinge .....	411
Penisklemme, STOCKMANN .....	553/1	Pinzette, GOMEL .....	96	Polypenschnürer, KRAUSE .....	411, 433/2
Penisklemme, STRAUSS .....	553/1	Pinzette, GRADLE .....	395	Polypenschnürer, KRAUSE-VOSS .....	433/2
PENNINGTON, Arterienklemme .....	109	Pinzette, GRAEFE .....	83, 382, 389	Polypenschnürer, WILDE .....	411, 433/2
PENNINGTON, Septumelevator .....	438	Pinzette, GREEN .....	390	Polypenzange, BRUENINGS .....	425
PERCY, Retraktor .....	296	Pinzette, HESS .....	384, 391	Polypenzange, HARTMANN .....	424
Perforatorie, SMELLIE .....	607	Pinzette, HUNT .....	97	Polypenzange, HEYMANN .....	425
Peripheral-Gefäßsklemme, DeBAKEY .....	494	Pinzette, HUNTER .....	91	Polypenzange, HEYMANN-KNIGHT .....	425
Peripheral-Gefäßsklemme, LELAND-JONES .....	494	Pinzette, JACKSON .....	471	Polypenzange, JURASZ .....	471
Peritoneumklemme, FAURE .....	123	Pinzette, JAMESON .....	385	Polypenzange, KNIGHT .....	425
Peritoneumklemme, MIKULICZ .....	123	Pinzette, JANSEN .....	424	Polypenzange, LITTAUER.....	425
Peritoneumklemme, PHANEUF .....	123	Pinzette, JANSEN-GRUENWALD .....	424	Polypenzange, LUBET-BARBON.....	424
PERKINS, Wundspreizer .....	168	Pinzette, KALT .....	391	Polypenzange, NOYES.....	425
Perkussionshammer, BABINSKY .....	24	Pinzette, KIRBY-ARTHUR.....	385	Polypenzange, WESTMACOTT .....	424
Perkussionshammer, BERLINER.....	24	Pinzette, KNAPP-LUER .....	393	POOLE, Saugrohr .....	27
Perkussionshammer, BUCK .....	24	Pinzette, LANE .....	84	POST MORTEM .....	269
Perkussionshammer, TAYLOR .....	24	Pinzette, LERCHE.....	83	POTTS, Anastomosen-Klemme .....	493
Perkussionshammer, TROEMNER .....	24	Pinzette, LESTER .....	389	POTTS, Coarctations-Klemme .....	492
PERTHES, Pfiem .....	304	Pinzette, LITTAUER .....	395	POTTS, Gefäßklemme .....	492, 493
PIFFALDOZZA, Abortuskürette .....	606	Pinzette, LONDON-COLLEGE .....	93	POTTS-DeMARTEL, Gefäßschere .....	59
PETRI, Schale.....	620	Pinzette, LUCAE .....	410	POTTS-SMITH, anatomische Pinzette.....	81
PETZ, Magen- und Darmnähsapparat .....	549	Pinzette, MAYO .....	89	POTTS-SMITH, chirurgische Pinzette .....	81
Pfiem .....	304	Pinzette, McCULLOUGH .....	385	POTTS-SMITH, Gefäßschere .....	61
Pfiem, PERTHES .....	304	Pinzette, McINDOE.....	85	POZZI-PALMER, Hakenzange .....	582
Phalagenmesser .....	44	Pinzette, MCPHERSON .....	392	Präparierschere .....	52
PHANEUF, Peritoneumklemme .....	123	Pinzette, MERIAM .....	93	Präparierschere, DEAVER .....	52
PIERCE, Kieferhöhlentrokär .....	204	Pinzette, Mikrochirurgie.....	94, 96	Präparierschere, JORGENSEN .....	53
PIERCE, Septumelevator .....	438	Pinzette, MOD. BONN .....	387	Präparierschere, LEXER .....	53
PIFFARD, Lupuskürette .....	608	Pinzette, MOD. TÜBINGEN .....	387, 392	Präparierschere, LEXER-BABY .....	53
PILLING, Clipanlegezange .....	524, 525	Pinzette, Monopolar.....	634	Präparierschere, MAYO .....	52/1
PINARD, Stethoskop .....	23	Pinzette, MOORFIELD .....	392	Präparierschere, MAYO-NOBLE .....	52/1
Pinzette, ADLERKREUTZ .....	84	Pinzette, NELSON .....	89	Präparierschere, MAYO-STILLE .....	52/1
Pinzette, ADSON.....	81/2, 82, 334	Pinzette, OCHSNER .....	88	Präparierschere, METZENBAUM .....	53/1
Pinzette, ADSON-BROWN .....	82	Pinzette, OEHLER .....	81/1	Präparierschere, METZENBAUM FINO .....	53/1
Pinzette, ADSON-DeBAKEY .....	81/2	Pinzette, PAUFIQUE .....	392	Präparierschere, PECK-JOSEPH .....	74
Pinzette, anatomisch .....	81	Pinzette, POTTS-SMITH .....	81	Präparierschere, TOENNIS-ADSON .....	65
Pinzette, ARRUGA.....	391	Pinzette, PRINCE .....	387	Präparierschere, WELLER.....	53/2
Pinzette, atrauma .....	98, 99	Pinzette, REDA .....	395	PRATT, Dilator .....	580
Pinzette, AYER.....	393	Pinzette, SCHWEIGGER .....	391	PRATT, Fasszange .....	110
Pinzette, BARRAQUER .....	384, 390, 395	Pinzette, SEMKEN .....	86	PRATT, Fistelsonde .....	563
Pinzette, BARRAQUER-KATZIN .....	384	Pinzette, SINGLEY .....	88	PRATT, Hakenzange .....	584
Pinzette, BEER .....	395	Pinzette, SNELLEN .....	393	PRATT, Mastdam-Spekula .....	559
Pinzette, BERKE .....	389	Pinzette, STEVENS .....	383	PRATT, Uterus-Dilatator .....	580
Pinzette, bipolar .....	630 - 632	Pinzette, STILLE .....	81	PRECISA, Blutdruckmessgerät .....	9

PRESBYTERIAN, Schlauchklemme .....	129	Raspel, GALLAHER .....	446	Ringmesser, LAFORCE .....	450
PRICE-THOMAS, Bronchusklemme .....	490	Raspel, JOSEPH .....	443, 446	Ringmesser, St. CLAIR-THOMSON .....	450
PRINCE, Muskelpinzette .....	387	Raspel, JOSEPH (LEWIS) .....	443	Rippenkontraktor, BAILEY .....	489/1
PRINCE, Tonsillenscherer .....	59	Raspel, MALTZ .....	443	Rippenkontraktor, BAILEY-BABY .....	489/1
PROBE AND PACKER .....	612	Raspel, MALTZ (COTTLE) .....	444	Rippenkontraktor, BAILEY-GIBBON .....	489/1
Profundaklemme, GREGORY .....	517	Raspel, MILLER .....	444	Rippenkontraktor, SELLORS .....	489/1
Proktoskop, BENSAUDE .....	565	Raspel, PEET .....	446	Rippenscherer .....	480
Proktoskop, CHELSEA-EATON .....	563	Raspel, WIENER .....	443	Rippenscherer, BETHUNE .....	481
Proktoskop, FANSLER .....	564	Rauchabsaugrohr, KLEINSASSER .....	36	Rippenscherer, BRUNNER .....	481
Proktoskop, HIRSCHMANN .....	563	RAY, Hypophysenkürette .....	334	Rippenscherer, COLLIN .....	480
Proktoskop, IVES-FANSLER .....	563	RECAMIER, Uteruskürette .....	597, 598	Rippenscherer, CORYLLOS .....	480
Proktoskop, KELLY .....	563, 564	Recordspritze .....	596	Rippenscherer, GIERTZ-STILLE .....	481
Proktoskop, MORGAN .....	565	REDA, Amputationsmesser .....	44	Rippenscherer, GLUCK .....	480
Prostatafasszange, MILLIN .....	550, 551	REDA, Augenmagnet .....	395	Rippenscherer, SAUERBRUCH .....	481
Prostatahaken, YOUNG .....	550	REDA, Cilienpinzette .....	395	Rippenscherer, SAUERBRUCH-FREY .....	481
PROVIDENCE-HOSPITAL, Arterienklemme .....	106	REDA, EXCENTER, Verbandschere .....	69/2	Rippenscherer, STILLE .....	480
Pulverbläser, KABIEFSKE .....	405	REDA, Fadengabel .....	221	Rippensperrer, CHERRY .....	488
Pulverbläser, UNIVERSAL .....	405	REDA, Fingerringssäge .....	297	Rippensperrer, COOLEY .....	485, 487
Pumpe f. Komprimierer .....	295	REDA, Führungsohlschleife .....	221/1	Rippensperrer, COOLEY-NEONATAL .....	485
Punktionskanüle, FRAZIER .....	337	REDA, Gipsspreizer .....	232	Rippensperrer, DeBOER .....	486
PUTTI, Knochenraspel .....	294	REDA, Handbohrapparat .....	300	Rippensperrer, FINOCHIETTO .....	482, 484
Pylorusspreizer, BENSON .....	544	REDA, Hauthäkchen .....	150	Rippensperrer, FINOCHIETTO-BABY .....	482
Q		REDA, Kappenzange .....	615	Rippensperrer, FINOCHIETTO-BURFORD .....	483
QUERVAIN, Elevator .....	275	REDA, Klingenbrecher .....	45	Rippensperrer, HAIGHT .....	487
QUINBY, Zahnfleischschere .....	67	REDA, Knochenhaltezange .....	246, 247	Rippensperrer, MORSE .....	484
QUIRE, Fremdkörperheber .....	412	REDA, Mikro-Rohrschaftzange .....	474	Rippensperrer, MORSE-FAVALORO .....	484
QUISLING, Hammer .....	271	REDA, Nasenspekulum .....	423	Rippensperrer, RIENHOFF-FINOCHIETTO .....	486
R		REDA, Organ- u. Gewebefäßzange .....	111	Rippensperrer, TUFFIER .....	487
Rachiotom .....	267	REDA, Parametriumklemme .....	128/1	RITTER-HALLE, Stirnhöhliendilatator .....	433
RADOLF, Nagelausschneidzange .....	297	REDA, Parametriumschere .....	63	ROBB, Spatel .....	530/1
RAGNELL, Wundhaken .....	140	REDA, scharfer Löffel .....	256	ROBERTS, Arterienklemme .....	117
Rahmen, DENIS-BROWNE, Bauchdeckenhalter .....	185	REDA, Sichelmesser .....	435	ROCHARD, Bauchdeckenhalter .....	186
Rahmen, KIRSCHNER, Bauchdeckenhalter .....	185 - 187/1	REDA, Watteträger .....	203	ROCHARD, Fixiervorrichtung .....	186
Rahmen, O'SULLIVAN-O'CONNOR .....	576	REDON, Führungsnadel .....	207	ROCHESTER-CARMALT, Arterienklemme .....	109
RALK, Handbohrapparat .....	300	REES, Face-Lift-Schere .....	73	ROCHESTER-OCHSNER, Arterienklemme .....	108
RAMPLEY, Tupferzange .....	136	Reibahle .....	304	ROCHESTER-PEAN, Arterienklemme .....	108
RAMUS, Wundhaken .....	461	REICHERT, Kehldeckelhalter .....	471	ROEDER, Tuchklemme .....	132
RANDALL, Biopsiekürette .....	587	REILL, Knochenhaltezange .....	248	ROGER, Septumelevator .....	437
RANDALL, Nierensteinzange .....	535	REINER, Gipsmesser .....	233	ROGERS, Hysterektomieklammer .....	127
RANEY, Klammeranlagezange .....	327	REINER, Ohrspritze .....	406	ROGGE, Sterilisierzange .....	227
RANEY, Kopfhautklammern .....	45	Reinigungsaufsatz .....	626	Rohrschaftzange, REDA .....	474
Rasierklammer .....	45	Reinigungspistole .....	626	Rollenklemme .....	131
Rasiermesser .....	49	Rektal-Absaugrohr, BUJE .....	566	Rollenklemme, BÜLOW-GUNAR-HEY .....	130
Raspatorium .....	279	Rektal-Schnürer, WESTON .....	566	ROLLET, Exstipationsmeißel .....	374
Raspatorium, ADSON .....	282	Rektal-Spekulum, SAWYER .....	560	ROLLET, Tränensackhäkchen .....	375
Raspatorium, ALEXANDER .....	276	Rektal-Spekulum, HILL-FERGUSON .....	560	Rongeur, CLOWARD .....	342
Raspatorium, COBB .....	280	Rektum-Anastosenklemme, HAYES .....	545	Rongeur, CUSHING .....	340
Raspatorium, DINGMANN .....	463, 463/3	Repositionszange, ROWE .....	459	Rongeur, DECKER .....	341
Raspatorium, DOYEN .....	278	RESANO, Darmklemme .....	542	Rongeur, FERRIS-SMITH .....	343
Raspatorium, FARABEUF .....	274	RESANO, Kapselschere .....	53/2	Rongeur, LANDOLT .....	341/2
Raspatorium, FARABEUF-COLLIN .....	274	Resektionsmesser .....	47	Rongeur, LOVE-GRUENWALD .....	340
Raspatorium, FOMON .....	277	Retraktor .....	463/1	Rongeur, OLDBERG .....	341/1
Raspatorium, GUILLEN .....	433/1	Retraktor, PERCY .....	296	Rongeur, PEAPOD .....	341/1
Raspatorium, HARGIS .....	463/2	Retraktoren, Intraoral .....	463/1, 463/4	Rongeur, SCHLESINGER .....	342
Raspatorium, JOSEPH .....	277	Retraktor-System, LEYLA .....	368 - 368/4	Rongeur, SPURLING .....	340
Raspatorium, KÖNIG .....	276	REVERDIN, Darmspatel .....	143/3	Rongeur, WAGNER .....	343
Raspatorium, LAMBOTTE .....	274	REVERDIN, Nadel .....	220	ROSE, Wundhaken .....	140
Raspatorium, LANGENBECK .....	275	REYNOLDS, chirurgische Schere .....	54/1	ROSEN, Messer .....	418
Raspatorium, MATSON .....	279	REYNOLDS, Supercutschere .....	72	ROSEN, Nadel .....	419
Raspatorium, MATSON-ALEXANDER .....	279	Rhinoplastikschere, FOMON .....	65/1	ROSEN, Saugkanüle .....	338
Raspatorium, MOLT .....	276	RIBBON, Bauch- u. Darmspatel .....	143/1	ROSER-KOENIG, Mundsperr .....	454
Raspatorium, OBWEGESER .....	462	RICARD, Bauchdeckenhalter .....	191	ROSS, Aortahaken .....	148/1
Raspatorium, QUERVAIN .....	275	RICHARDSON, Wundhaken .....	142	ROUX-BABY, Wundhaken .....	140
Raspatorium, SEBILAU .....	275	RICHARDSON-EASTMAN, Wundhaken .....	142	ROUX, Wundhaken .....	140
Raspatorium, SEDILLOT .....	274, 275	RICHARDSON-GRIP, Wundhaken .....	142	ROUX, Wundhaken .....	139
Raspatorium, SELDIN .....	277	RICHNAU-HOLMGREN, Ohrspekula .....	400	ROWE, Repositionszange .....	459
Raspatorium, SEMB .....	278	RICHTER-HEATH, Wundklammerzange .....	224	RUBIN, Septummeißel .....	440
Raspatorium, WILLIGER .....	276	RIENHOFF-FINOCHIETTO, Rippensperrer .....	486	RUBIN, Septumzange .....	428
Raspatorium, MOLT .....	276	RIGBY, Bauchdeckenhalter .....	189/2	RUDD, Hämorrhoidal-Ligator .....	568
Raspel, AUFRICHT .....	443	Ri-MINI, Diagnostik-Besteck .....	17	RUMEL, Arterienklemme .....	117
Raspel, FOMON .....	444, 445	RING, Zungenspatel .....	455	RUMEL-BELMONT, Tourniquet .....	528
		Ringmesser, BARNHILL .....	450	RUMEL-DeBAKEY, Gefäßklemme .....	499
		Ringmesser, BECKMANN .....	450	RUSKIN, Hohlmeißelzange .....	239

RUSKIN-LISTON, Knochensplitterzange .....241  
 RUSSEL-DAVIS, Zungenspatel .....458  
 RUSSISCHES MODELL, Fasspinzette.....85  
 RYDEL-SEIFFERT, Stimmgabel.....404  
 RYDER, Nadelhalter .....210

**S**

Säge, GIGLI .....332  
 Sägeblatt ..... 230/14 - 230/17  
 Sägeblatt, Fingerringssäge .....297  
 SAALFELD, Komedonenquetscher .....608  
 SACHS, Dura-Dissektor .....332  
 SACHS, Nervhaken .....329  
 SAENGER, Abortuszange .....606  
 Saigittalspreizer, SMITH.....463/5  
 Saipingograph, SCHULTZE .....596  
 SANVENERO, chirurgische Schere.....54/1  
 SAROT, Arterienklemme .....118  
 SAROT, Nadelhalter .....211  
 SATINSKY, Gefässklemme .....491  
 SATINSKY, Gefässschere .....65/2  
 SATINSKY, Tangentialklemme .....502  
 SATO, Hornhautmesser .....373  
 Sattelhäkchen .....151, 152  
 Sattelhäkchen, CUSHING .....151, 152  
 Sattelhäkchen, DESMARRES.....151  
 Sattelhäkchen, GIL-VERNET .....152  
 SATTERLEE, Amputationssäge.....296  
 SAUERBRUCH, Abfallzange.....227  
 SAUERBRUCH, Hohlmeisselzange.....240  
 SAUERBRUCH, Rippenschere .....481  
 SAUERBRUCH, Wundhaken.....164, 166  
 SAUERBRUCH-FREY, Rippenschere.....481  
 Sauggriff, WULLSTEIN .....338  
 Saugkanüle, ROSEN .....338  
 Saugkanüle, SCHMID .....338  
 Saugkürette, NOVAK .....587  
 Saugkürette, RANDALL.....587  
 Saugraspatorium, GUILLEN.....433/1  
 Saugrohr .....337/1  
 Saugrohr, ADSON.....337  
 Saugrohr, ANDREW-PYNCHON.....28  
 Saugrohr, BABY-YANKAUER.....27  
 Saugrohr, BARON.....336  
 Saugrohr, COOLEY .....28  
 Saugrohr, DeBAKEY .....28  
 Saugrohr, FERGUSSON .....337  
 Saugrohr, FRAZIER/FERGUSSON .....337  
 Saugrohr, HOUSE .....337/2  
 Saugrohr, PLESTER.....338  
 Saugrohr, POOLE .....27  
 Saugrohr, ROSEN .....338  
 Saugrohr, SCHMID .....338  
 Saugrohr, YANKAUER .....27  
 Saugrohr, YASARGIL.....337/1  
 Saugrohr, ZÖLLNER.....337/1  
 Saugschlauch .....231  
 SAWTELL, Tonsillenzange .....467  
 SAWYER, Rektal-Spekulum .....560  
 SAYRE, Elevator .....281  
 SCAGLIETTI, Hohlmeisselzange .....240  
 SCALP-CONTOUR, Wundspreizer .....169  
 Schädelhalter, CRUTCHFIELD .....327  
 Schädelspalter .....267  
 Schädelstanze, CONE.....331  
 Schädelzange, DeVILBISS .....332  
 SCHAEDEL, Tuchklemme .....132  
 Schaff .....230/4, 230/7  
 Schale, PETRI.....620  
 Schälmesser, Tracheotomie .....475  
 SCHAMBERG, Komedonenquetscher .....608  
 Scharfer Löffel .....255  
 Scharfer Löffel, BRUNS .....251, 254

Scharfer Löffel, BUSHE .....256  
 Scharfer Löffel, COBB.....252  
 Scharfer Löffel, DAUBENSPECK .....255  
 Scharfer Löffel, HALLE .....253  
 Scharfer Löffel, JACOBSON .....257  
 Scharfer Löffel, JANSEN .....257  
 Scharfer Löffel, LEMPERT.....256  
 Scharfer Löffel, MARTINI .....257  
 Scharfer Löffel, REDA .....256  
 Scharfer Löffel, SCHEDE .....251  
 Scharfer Löffel, SCOVILLE .....253  
 Scharfer Löffel, SPINAL .....253  
 Scharfer Löffel, SPRATT.....251  
 Scharfer Löffel, VOLKMANN .....257  
 Scharfer Löffel, WILLIGER .....255, 257  
 SCHEDE, scharfer Löffel .....251  
 Scheidenspekula .....569 - 577  
 Scheidenspekula, AUWARD .....576  
 Scheidenspekula, BREISKY .....577  
 Scheidenspekula, COLLIN .....570  
 Scheidenspekula, CUSCO .....570, 571  
 Scheidenspekula, DELEE .....574  
 Scheidenspekula, DOYEN.....574  
 Scheidenspekula, GRAVE .....570  
 Scheidenspekula, JACKSON .....573  
 Scheidenspekula, KALLMORGEN .....573  
 Scheidenspekula, KRISTELLER .....572  
 Scheidenspekula, LANDAU .....577  
 Scheidenspekula, O'SULLIVAN-O'CONNOR.....576  
 Scheidenspekula, PEDERSON .....570  
 Scheidenspekula, SCHERBAK .....575  
 Scheidenspekula, SEMM .....571  
 Scheidenspekula, SIMS .....573  
 Scheidenspekula, TRELAT .....571  
 Scheidenspekula, VU-MORE .....569  
 SCHEIE, Goniotomiemesser .....373  
 SCHEINMANN, Aufsatz.....472  
 SCHERBAK, Scheidenspekula .....575  
 Schere, AEBLI .....58  
 Schere, BABY-METZENBAUM .....71  
 Schere, BARRAQUER .....75  
 Schere, BEEBEE .....68  
 Schere, BERGMANN.....69/1  
 Schere, BETHUNE.....481  
 Schere, BOETTCHER .....59  
 Schere, BRAUN-STADLER.....64  
 Schere, BRUNNER .....481  
 Schere, BRUNS .....70  
 Schere, BUSCH .....64  
 Schere, CASTROVIEJO .....79  
 Schere, COLLIN .....480  
 Schere, COTTLE .....56, 59  
 Schere, CORYLLOS .....480  
 Schere, CRAFOORD .....65/2  
 Schere, DEAN .....59  
 Schere, DeBAKEY .....60, 61  
 Schere, DIETRICH .....60  
 Schere, DOYEN .....63  
 Schere, DUBOIS.....63  
 Schere, ESMARCH .....69/2  
 Schere, FAVALORO .....61  
 Schere, FERGUSSON .....66  
 Schere, FOMON .....58, 65/1  
 Schere, FREEMAN .....74  
 Schere, GLUCK .....480  
 Schere, GOLDMAN-FOX .....67  
 Schere, GOMEL .....80  
 Schere, GOOD.....59  
 Schere, GORNEY .....73  
 Schere, GRADLE .....57  
 Schere, GRAEFE .....56  
 Schere, Haut.....610  
 Schere, HEATH.....66

Schere, HEPP-SCHEIDEL .....78  
 Schere, HEYMANN.....58  
 Schere, IRIS .....54/2, 72  
 Schere, JORGENSEN.....53  
 Schere, JOSEPH .....54/1  
 Schere, KAYE .....73  
 Schere, KELLY .....61  
 Schere, KILLIAN .....471  
 Schere, KILNER.....54/1  
 Schere, KILNER/RAGNELL .....72  
 Schere, KLINKENBERGH-LOTH.....65/2  
 Schere, KNAPP .....55  
 Schere, KNOWLES .....70  
 Schere, LA GRANGE.....69, 72  
 Schere, LANDOLT .....58  
 Schere, LEXER .....53  
 Schere, LEXER-BABY .....53  
 Schere, Ligatur, TC .....54  
 Schere, LISTER .....69/1, 72  
 Schere, LITTAUER .....66  
 Schere, LITTLER .....55  
 Schere, LOCKLIN .....69  
 Schere, LORENZ .....70  
 Schere, MARTIN .....65/1  
 Schere, MAYO .....52/1, 71  
 Schere, MAYO-NOBLE .....52/1  
 Schere, MAYO-STILLE .....52/1, 71  
 Schere, McINDOE .....65/1  
 Schere, METZENBAUM .....53/1, 54, 71  
 Schere, MIKRO .....76  
 Schere, Nagel .....609, 610  
 Schere, Neurochirurgie.....65  
 Schere, NORTHBENT .....66  
 Schere, NOYES .....75  
 Schere, Parametrium.....63  
 Schere, PECK-JOSEPH .....74  
 Schere, POTTS-DeMARTEL .....59  
 Schere, POTTS-SMITH .....60, 61  
 Schere, PRINCE .....59  
 Schere, QUINBY .....67  
 Schere, REDA .....77, 80  
 Schere, REDA EXCENTER .....69/2  
 Schere, REES .....73  
 Schere, RESANO .....53/2  
 Schere, REYNOLDS.....54/1, 72  
 Schere, SANVENERO .....54/1  
 Schere, SATINSKY .....65/2  
 Schere, SAUERBRUCH.....481  
 Schere, SAUERBRUCH-FREY .....481  
 Schere, SCHMIEDEN-TAYLOR .....65/1  
 Schere, SCHUMACHER .....64, 481  
 Schere, SEUTIN .....69/2  
 Schere, SIEBOLD .....62  
 Schere, SIMS .....62  
 Schere, SMITH-US-ARMY.....69/1  
 Schere, Standard.....51  
 Schere, STILLE .....480  
 Schere, STEVENS .....58, 72  
 Schere, STRULLY .....65  
 Schere, SYSTRUNK .....66  
 Schere, THOREK .....65/2  
 Schere, TOENNIS-ADSON .....65  
 Schere, UNIVERSAL.....67, 70  
 Schere, USA Mod.....64  
 Schere, VANNAS .....79  
 Schere, WAGNER.....67, 72  
 Schere, WALDMANN.....64  
 Schere, WECKER.....75  
 Schere, WELLER .....53/2  
 Schere, WERTHEIM .....63  
 Schere, WESTCOTT .....75  
 Schieblehre, TOWNLEY .....26  
 Schielhaken, GRAEFE .....375

Schielhaken, JAMESON.....	375	Sehenschäler, BUNNELL.....	292	Siebschale.....	623
Schilddrüsenhaken, SCHOENBORN.....	479	SEIFERT, Aufsatz.....	472	SIEGLE, Ohrspekula.....	402
SCHIMMELBUSCH, Verbandstoffrommel.....	622	Sektionsnadel.....	268	Silberklammern.....	326
SCHINK, Dermatome.....	49	SELDIN, Raspor.....	277	Silikoneinlage, DAVIS-BOYLE.....	455
SCHIOETZ, Tonometer.....	394/2	SELECT, Verbindungskabel.....	633	Silikonschlauch, McIVOR.....	457
Schlauchhalterung.....	188	SELLHEIM, Geburtsöffel.....	607	SILVER, Dermatome.....	50
Schlauchklemme.....	129	SELLORS, Rippenkontraktor.....	489/1	SILVER, Septummeissel.....	442
Schlauchklemme, BÜLOW-GUNAR-HEY.....	130	SEMB, Bronchusklemme.....	491	SIMCOE, Spülkanüle.....	394/2
Schlauchklemme, HOFFMANN.....	624	SEMB, Hohlmeisselzange.....	240	SIMON, Uterusöffel.....	594
Schlauchklemme, KLINIKUM BERLIN.....	129	SEMB, Knochenhaltezeuge.....	243	SIMON, Wundhaken.....	164
Schlauchklemme, PRESBYTERIAN.....	129	SEMB, Knochensplittierzange.....	242	SIMPLEX, Schlauchklemme.....	624
Schlauchklemme, SIMPLEX.....	624	SEMB, Raspor.....	278	SIMPSON, Geburtszange.....	602
Schlauchverbindungsstück.....	600	SEMKEN, anatomische Pinzette.....	86	SIMPSON-BRAUN, Geburtszange.....	602
SCHLESINGER, Laminektomiezeuge.....	342	SEMKEN, chirurgische Pinzette.....	86	SIMPSON-LUIKART, Geburtszange.....	603
Schliessklemme, STONE.....	545	SEMM, Scheidenspekula.....	571	SIMS, gynäkologische Schere.....	62
Schlinge, Polypenschnürer.....	433/2	SENN-GREEN, Wundhaken.....	153	SIMS, Mastdarm-Spekula.....	559
Schlüssel, Meissel.....	266	SENN-MILLER, Wundhaken.....	143	SIMS, Scheidenspekula.....	573
Schlüssel, Osteotome.....	266	Septemzange, KNIGHT.....	425	SIMS, Sonde.....	586
Schlüsselpaar, Gips säge u. Autopsiesäge.....	230/18	Septemzange, HEYMANN.....	425	SIMS, Uterusdepressor.....	586
SCHMEDEN, Nasenzange.....	427	Septumhohlmeissel, FREER.....	442/1	SIMS, Uterusdilator.....	581
SCHMID, Gefäss- u. Spülkanüle.....	338	Septumhohlmeissel, HAJEK.....	442/1	SIMS, Uteruskürette.....	597, 598
SCHMIEDEN, Führungshohlsonde.....	221	Septumhohlmeissel, KILLIAN-CLAUS.....	442/1	SIMS, Uterussonde.....	586
SCHMIEDEN-DICK, Unterbindungsnadel.....	219	Septumelevator, BALLENGER.....	439	SIMS-MAIER, Kornzange.....	134
SCHMIEDEN-TAYLOR, Duraschere.....	65/1	Septumelevator, COTTLE.....	439	SINGLEY, Gewebefasspinzette.....	88
Schnellkupplungs-Handgriff.....	301	Septumelevator, COTTLE-JOSEPH.....	439	SINOSKOPIE-TROKAR.....	205
Schnellkupplungs-T-Handgriff.....	300, 301	Septumelevator, FREER.....	437, 439	SINSKEY, Häkchen.....	376
SCHNIDT, Tonsillenzange.....	467	Septumelevator, HAJEK-BALLENGER.....	439	SINUS, Septumelevator.....	438
SCHOENBORN, Schilddrüsenhaken.....	479	Septumelevator, HALLE.....	437	Sinuskopie-Zange.....	431
Schraubenhaltehülse.....	324	Septumelevator, HOWARTH.....	438	Skalpel Mini.....	41
Schraubenhaltezeuge, LANE.....	325	Septumelevator, JOSEPH.....	437	Skalpel, steril.....	43
Schraubenzieher, Ferrozellgriff.....	323	Septumelevator, KILLIAN.....	438, 439	Skalpellgriff.....	38-42
Schraubenzieher, LANE.....	323, 324	Septumelevator, McKENTY.....	437, 438	Skalpellgriff Mini.....	41
Schraubenzieher, WILLIAMS.....	323	Septumelevator, PENNINGTON.....	438	Skalpellklingen.....	42
SCHRÖDER, Hakenzange.....	584	Septumelevator, PIERCE.....	438	Skalpellklingen-Entferner.....	42
SCHRÖDER, Uterusöffel.....	595	Septumelevator, ROGER.....	437	SKENE, Hakenzange.....	582
SCHROEDER, Hakenzange.....	583	Septumelevator, SINUS.....	438	Sklerotom, GUYTON-LUNDSSGAARD.....	373
SCHROEDER (POZZI), Hakenzange.....	582	Septummeissel, CINELLI.....	441	Sklerotom, LUNDSSGAARD.....	373
SCHUBERT, Biopsiezange.....	588	Septummeissel, COTTLE.....	440	SLS, Cipanlegezeuge.....	524, 525
SCHUKNECHT, Messer.....	418	Septummeissel, FOMON.....	441	SLUDER-BALLENGER, Tonsillotom.....	470
SCHULTZE, Salpingograph.....	596	Septummeissel, FREER.....	439	SMELLIE, Haken.....	605
SCHULZE-BERGMANN, Mastdarm-Spekula.....	560	Septummeissel, NEIVERT-ANDERSON.....	442	SMELLIE, Perforatorie.....	607
SCHUMACHER, Aufsatz.....	472	Septummeissel, RUBIN.....	440	SMILLIE, Knochenhebel.....	291
SCHUMACHER, Biopsiezange.....	588	Septummeissel, SHEEHAN.....	441	SMILLIE, Meniskusmesser.....	292
SCHUMACHER, Nabelschnurschere.....	64	Septummeissel, SILVER.....	442	SMITH, Lidsperrer.....	370
SCHUMACHER, Sternumschere.....	481	Septumosteotom, CINELLI.....	441	SMITH, Sagittalspreizer.....	463/5
SCHUMACHER, Uterus-Biopsiezange.....	589	Septumosteotom, FOMON.....	441	SMITH, Spreizer.....	463/5
Schüssel.....	619	Septumosteotom, SHEEHAN.....	441	SMITH, Spreizzange.....	463
Schwammzange.....	136	Septumrichtzange, ASCH.....	449	SMITH US ARMY, Verbandschere.....	69/1
Schwammzange, FOERSTER.....	136	Septumrichtzange, WALSHAM.....	449	SMITH-BUIE, Analspreizer.....	561
Schwammzange, RAMPLEY.....	136	Septumschere, KILLIAN.....	471	SMITH-PETERSEN, Hohlmeissel.....	261
SCHWEIGGER, Kapselpinzette.....	391	Septumzange, BRUENINGS.....	425	SMITH-PETERSEN, Hohlmeisselzange.....	238
Schwingmesser, BALLENGER.....	436	Septumzange, GRAIG.....	426	SMITH-PETERSEN, Osteotom.....	261
SCOVILLE, Haken.....	196	Septumzange, LUC.....	426	SMITHWICK, Anlegezange.....	326
SCOVILLE, Laminektomiespreizer.....	196	Septumzange, MIDDLETON-JANSEN.....	430	SMITHWICK, Nervhaken.....	329
SCOVILLE, Nervwurzelhaken.....	329/1, 330	Septumzange, RUBIN.....	428	SNELLLEN, Muskelpinzette.....	393
SCOVILLE, scharfer Löffel.....	253	Sequesterzange.....	249	SNELLEN, Starschlinge.....	378
SCOVILLE-HAVERFIELD, Laminektomiespreizer.....	196	SERPENTINE-GRASPER, Fasszange.....	593	SOMER, Uterus-Fasszange.....	585
SCUDDER, Darmklemme.....	541	Set Doppel-Sägeblatt.....	230/7	Sonde.....	199, 335
SEBILÉAU, Raspor.....	275	Set Filtertüten.....	231/1	Sonde, BRODIE.....	199
SEDLLOT, Raspor.....	274, 275	Set Sägeblatt.....	230/5, 230/6	Sonde, COLLIN.....	586
Segment sägeblatt.....	230/5, 230/15	SEUTIN, Verbandschere.....	69/2	Sonde, DOYEN.....	199
SEGOND, Hysterektomieklammer.....	125	SEXTON, Ohrmesser.....	408	Sonde, FISH.....	199
SEGOND, Myommesser.....	594	Seziermesser, VIRCHOW.....	48	Sonde, HARMS.....	381
SEGOND-LANDAU, Hysterektomieklammer.....	125	SHAMBAUGH, Häkchen.....	419	Sonde, JACOBSON.....	335
Sehnenfassinstrument, BRAND.....	293	SHAPLEIGH, Ohrschlinge.....	410	Sonde, LOCKHART-MUMMERY.....	200
Sehnenfassinstrument, CAROLL.....	293	SHEA, Mikro-Ohrschere.....	413	Sonde, MARTIN.....	586
Sehnenfassinstrument, KLEINERT-KUTZ.....	294	SHEEHAN, Osteotom.....	441	Sonde, NELATON.....	199
Sehnenfasspinzette, LARSEN.....	292	SHEEHAN, Septummeissel.....	441	Sonde, PRATT.....	563
Sehnenfasszange.....	293	SHEETS, Augenkanüle.....	394/2	Sonde, SIMS.....	586
Sehnenfasszange, JACKSON.....	292	Sichelmesser, REDA.....	435	Sonde, STACKE.....	199
Sehnenführer, BUNELL.....	294	Sichelmesser, Tracheotomie.....	475	Sonde, VALLEIX.....	586
Sehnenhaltezeuge, STEINMANN.....	292	Siebkorb, Endoskope u. Lichtleiterkabel.....	623	Sonde, WATSON-CHEYNE.....	199
Sehenschäler, BRAND.....	294	Siebold, gynäkologische Schere.....	62	Sonde, WORST.....	381

Sondenspitzen, NABATOFF .....	201	SPURLING, Laminektomiezange .....	340	STILLE-LUER, Hohlmeisselzange .....	239
Spannarm, flexibel, LEYLA .....	368/3	Sputumbecher .....	621/1	STILLE-RUSKIN, Hohlmeisselzange .....	239
Spannplatte .....	49	St. CLAIR-THOMSON, Ringmesser .....	450	STILLE-SHERMAN, Handbohrapparat .....	298
Spannschlüssel .....	313	St. MARKS, Wundhaken .....	165	Stimmgabel .....	403, 404
Spatel .....	203, 530/1, 612/1	St. MARKS-PELVIS, Haken .....	165	Stimmgabel, HARTMANN .....	403
Spatel, KOCHER .....	552	St. MARTIN, Nahtpinzette .....	392	Stimmgabel, LUCAE .....	404
Spatel, LEGUEU .....	552	STACKE, Ohrsonde .....	199	Stimmgabel, RYDEL-SEIFFERT .....	404
Spatel, ROBB .....	530/1	STAMM, Knochensplitterzange .....	241	Stirnhöhliendilatator, RITTER-HALLE .....	433
SPATULA AND PACKER .....	612	Standard, chirurgische Schere .....	51	Stirnlampe, CLAR .....	22
Spekula, BARR .....	559	STANDARD (NELSON) Trokar .....	204	Stirnspiegel, ZIEGLER .....	21
Spekula, BODENHAMMER .....	559	Standgefäß .....	620	STOCKMANN, Penisklamme .....	553/1
Spekula, BREISKY .....	577	Stanze, Aorta .....	528	STONE, Schließklamme .....	545
Spekula, COLLIN .....	570	Stanze, CITELLI .....	430	STONE-WATT, Darmklamme .....	545
Spekula, CUSCO .....	570, 571	Stanze, COLCLOUGH .....	344/1	STONE-WATT, Klemmschloss .....	545
Spekula, CZERNY .....	559	Stanze, FERRIS-SMITH-KERRISON .....	344, 344/2	Stössel .....	258, 259
Spekula, DELEE .....	574	Stanze, HAJEK-KOFLER .....	429, 431	Stössel, CASPAR .....	258
Spekula, DOYEN .....	574	Stanze, KERRISON .....	428	STRABISMUS, Schere .....	58
Spekula, FRIEDMANN .....	577	Stanze, ÖSTROEM .....	430	Strabismuspinzette, BONACCOLTO .....	385
Spekula, GRAVE .....	570	Stanze, Zirkular .....	432	Strabismuspinzette, DASTOOR .....	386
Spekula, HILL-FERGUSON .....	560	Stariöffel, DAVIEL .....	377	Strabismuspinzette, JAMESON .....	385
Spekula, JACKSON .....	573	Stariöffel, GRAEFE .....	377	Strabismuspinzette, McCULLOUGH .....	385
Spekula, JOLL (FRIEDMANN) .....	577	Stariöffel, KNAPP .....	378	STRANDELL-STILLE, Wundhaken .....	157
Spekula, KALLMORGEN .....	573	Starmesser, DEUTSCHMANN .....	371	STRASSBURGER, Pinzette .....	89
Spekula, KOGAN .....	577	Starmesser, GRAEFE .....	371	STRATTE, Nadelhalter .....	212
Spekula, KRISTELLER .....	572	starrer Haltearm, LEYLA .....	368/1	STRAUSS, Penisklamme .....	553/1
Spekula, LANDAU .....	577	Starschlinge, ARLT .....	378	STRUEMPEL, Fremdkörperzangchen .....	412
Spekula, MATHIEU .....	560	Starschlinge, SNELLEN .....	378	STRULLY, neuro-chirurgische Schere .....	65
Spekula, O'SULLIVAN-O'CONNOR .....	576	Starschlinge, WEBER .....	378	STRUYCKEN, Nasenzange .....	427
Spekula, PEDERSON .....	570	Starschlinge, WILDER .....	378	SUBRAMANIAN, Kinder-Gefäßklamme .....	521
Spekula, PRATT .....	559	Stativ .....	188	SUBRAMANIAN-MINIATURE, Kinder-Gefäßklamme .....	521
Spekula, SAWYER .....	560	Staubbeutel .....	231/1	Supercutschere .....	71
Spekula, SCHERBAK .....	575	Staubbinde, ESMARCH .....	296	Supercutschere, BABY-METZENBAUM .....	71
Spekula, SCHULZE-BERGMANN .....	560	Staubsauger .....	231	Supercutschere, FREEMAN .....	74
Spekula, SEMM .....	571	STAUDE-MOORE, Hakenzange .....	582	Supercutschere, GORNEY .....	73
Spekula, SIMS .....	559, 573	Stechbecken .....	621/1	Supercutschere, IRIS .....	72
Spekula, TRÉLAT .....	571	STEINMANN, Knochennagel .....	307, 308	Supercutschere, KAYE .....	73
Spekula, VU-MORE .....	569, 570	STEINMANN, Sehenhalteze .....	292	Supercutschere, KILNER .....	72
SPENCER, Fadenschere .....	66	STELLBRINK, Hohlmeisselzange .....	234	Supercutschere, LISTER .....	72
SPENCER-WELLS, Arterienklamme .....	109	sterile Ersatzlinge .....	50	Supercutschere, MAYO .....	71
Sperrer, ALAN-PARKES .....	561	sterile Skalpell-Klingen .....	42	Supercutschere, MAYO-STILLE .....	71
Sperrer, DAVIS-BOYLE .....	455	Sterilisierkasten .....	616, 618	Supercutschere, METZENBAUM .....	71
Sperrer, DINGMANN .....	456	Sterilisierklammer, BUNT .....	227, 624	Supercutschere, REES .....	73
Sperrer, KILNER-DOUGHTY .....	456	Sterilisierklammer, MAYO .....	227, 624	Supercutschere, REYNOLDS .....	72
Sperrer, Mammaria .....	487/1	Sterilisiersiebschale .....	622	Supercutschere, STEVENS .....	72
SPINAL, scharfer Löffel .....	253	Sterilisierzange .....	227	Supercutschere, WAGNER .....	72
Spinalhaken, TAYLOR .....	291	Sterilisierzange, CHEATLE .....	227	SWEET, Anlegezange .....	326
SPINA-NASALIS, Wundhaken .....	461	Sterilisierzange, ROGGE .....	227	SYSTRUNK, chirurgische Schere .....	66
Spiralbohrer .....	302	Sterilisierzange, UNIVERSAL .....	227		
Spitze, YANKAUER Saugrohr .....	27	STERNBERG, Wangenhalter .....	453	<b>T</b>	
Splitterpinzette .....	91	Sternmeissel, LEBSCHKE .....	267, 480	TABB, Messer .....	418
Splitterpinzette, CARMALT .....	91	Sternschere, SCHUMACHER .....	481	Tablett .....	620
Splitterpinzette, FEILCHENFELD .....	91	Sternsperrer, Mammaria .....	487/1	TAKAHASHI, Nasenzange .....	427
Splitterpinzette, HUNTER .....	91	Stethoskop, ANESTOPHON .....	23	Tamponstopfer, LUNIATSCHEK .....	465
Splitterzange, ARCHER .....	92	Stethoskop, DUPLEX .....	23	Tamponzange, BOZEMANN .....	138
Splitterzange, PEET .....	92	Stethoskop, PINARD .....	23	Tamponzange, BOZEMANN-DOUGLAS .....	138
Splitterzange, STIEGLITZ .....	92	STEVENS, Irispinzette .....	383	Tangentialklamme, DeBAKEY .....	502
Splitterzange, VIRTUS (RALK) .....	92	STEVENS, Linsenhaken .....	375	Tangentialklamme, DeBAKEY-SATINSKY .....	502
SPRATT, scharfer Löffel .....	251	STEVENS, Nadelhalter .....	214	Tangentialklamme, SATINSKY .....	502
Spreizer, ALAN-PARKS .....	561	STEVENS, Sehnenschere .....	58	TARNIER, Geburtszange .....	604
Spreizer, BENSON .....	544	STEVENS, Supercutschere .....	72	TARNIER, Kranioclast .....	607
Spreizer, Lateral .....	569	STEVENS, Lidsperre .....	371	Taschenbesteck .....	226
Spreizer, LEGUEU .....	553	STIEGLITZ, Splitterzange .....	92	TAYLOR, chirurgische Pinzette .....	87
Spreizer, MILLIN .....	552	STILLE, Arterienklamme .....	122	TAYLOR, Haken .....	196
Spreizer, SMITH .....	463/5	STILLE, Flachmeissel .....	260	TAYLOR, Perkussionshammer .....	24
Spreizer, SMITH-BUIE .....	561	STILLE, Gipsschere .....	229	TAYLOR, Spinalhaken .....	291
Spreizer, THOMSON-WALKER .....	552	STILLE, Handbohrapparat .....	298	TC chirurgische Schere fein, REYNOLDS .....	54
Spreizzange, SMITH .....	463	STILLE, Hohlmeissel .....	260	TC chirurgische Schere, STANDARD .....	51
Spritze .....	407	STILLE, Osteotom .....	260	TC Nasenraspel, FOMON .....	445
Spritze gefüllt mit Fett .....	230/18	STILLE, Pinzette .....	81, 81/1	TC Pinzette, anatomisch .....	81
Spülkanüle, BISHOP-HARMON .....	394/1	STILLE, Rippenschere .....	480	TC Pinzette, chirurgisch .....	81/1
Spülkanüle, EICKEN (KILLIAN) .....	433	STILLE-BARRAYA, Gefäßpinzette .....	88	TC Pinzette, CUSHING .....	83
Spülkanüle, KILLIAN .....	433, 433/1	STILLE-HORSLEY, Knochensplitterzange .....	242	TC Pinzette, GILLIES .....	86
Spülkanüle, SIMCOE .....	394/2	STILLE-LISTON, Knochensplitterzange .....	242	TC Pinzette, SEMKEN .....	86



TC Pinzette, WAGENSTEIN .....	89	Tonsillenscherer, PRINCE .....	59	TUFFIER, Gewebefasszange .....	110
TC Schere, FREEMAN .....	74	Tonsillenschnürer, BRUENINGS .....	468	TUFFIER, Rippensperrer .....	487
TC Schere, GORNEY .....	73	Tonsillenschnürer, EVES .....	468	TUFFIER, Wundhaken .....	147
TC Schere, KAYE .....	73	Tonsillenschnürer, TYDING .....	469	Tumorfasszange, LANDOLT .....	341
TC Schere, PECK-JOSEPH .....	74	Tonsillenspritze .....	470	Tumorpinzette, YASARGIL .....	97
TC Schere, REES .....	73	Tonsillenzange, BALLENGER .....	467	Tupferzange, BRYANT .....	137
TEALE, Hakenzange .....	583	Tonsillenzange, BLOHMKE .....	467	Tupferzange, CHERON .....	137
TEBBETS, Wundhaken .....	197	Tonsillenzange, NEGUS .....	467	Tupferzange, COLLIN .....	137
Teleskop-Bohrdrahtstütze .....	299	Tonsillenzange, SAWTELL .....	467	Tupferzange, FOERSTER .....	136
TERSON, Kapselpinzette .....	391	Tonsillenzange, SCHNIDT .....	467	Tupferzange, LISTER (SINUS) .....	137
TESSIER, Haken .....	463/3	Tonsillenzange, TYDING .....	468	Tupferzange, PELKMANN .....	137
TESSIER, Mobilisierhaken .....	463/3	Tonsillenzange, WHITE .....	467	Tupferzange, RAMPLEY .....	136
T-Handgriff, HUDSON .....	300	Tonsillotom, SLUDER-BALLENGER .....	470	TURNBULL, Nagelzange .....	609
T-Handgriff, Schnellkupplung .....	300, 301	Tonsillotom, TYDING .....	469	TURREL, Mastdarmbiopsiezange .....	567
THIERRY, Geburtszange .....	603	TOOK, Hornhautmesser .....	373	TYDING, Tonsillenschnürer .....	469
THOMAS, Uteruskurette .....	599	Tourniquet, RUMEL-BELMONT .....	528	TYDING, Tonsillenzange .....	468
THOMAS-GAYLOR, Biopsiezange .....	588	TOWNLEY, Schieblehre .....	26	TYDING, Tonsillotom .....	469
THOMS-ALLIS, Darmfasszange .....	538	TOWNSEND, Uterus-Biopsiezange .....	591		
THOMSON-WALKER, Blasenwundspreizer .....	552	TOYBEE, Ohrspekula .....	399	U	
Thoraxsperrer, MERCEDES .....	489	Trachealhaken, BOSE .....	477	USA MOD., Nabelschnur-Schere .....	64
THOREK, Gallenblasenschere .....	65/2	Trachealdilatator, LABORDE .....	476	UCKERMANN, Watteträger .....	203
THUDICHUM, Nasenspekula .....	421	Trachealdilatator, TROUSSEAU .....	476	Uhmacher Pinzette .....	90
TIECK-HALLE, Nasenspekula .....	423	Trachealdilatator, TROUSSEAU-BABY .....	476	ULRICH, Knochenhaltezange .....	248
Tiefen-Messinstrument .....	594	Trachealhaken, ITERSON .....	477	ULRICH, Kornzange .....	135
Tiefensägeblatt .....	230/6, 230/16	Trachealhaken, JACKSON .....	476	ULTA-LIGHT, Pinzette, atrauma .....	95
TILLEY, Ohrzängchen .....	411	Trachealhaken, NEWS .....	477	UNI I, Diagnostik-Besteck .....	13
TISCHLER-DOWN, Uterus-Biopsiezange .....	591	Trachealkanüle, CHEVALIER-JACKSON .....	479	UNI III, Diagnostik-Besteck .....	15
TISCHLER-KEVORKIAN, Uterus-Biopsiezange .....	592	Trachealkanüle, LUER .....	479	UNIVERSAL, Drahtschere .....	67
TISCHLER-MORGAN, Uterus-Biopsiezange .....	590, 591	Trachealkanüle, WAGENER-MOSHER .....	477	UNIVERSAL, Endoskophalterung .....	188
TISCHLER-UP, Uterus-Biopsiezange .....	591	Trachealwundspreizer, BOSE .....	476	UNIVERSAL, Pulverbläser .....	405
Titan-Arterienklemme, CRILE .....	107	Trachompinzette, KNAPP-LUER .....	393	UNIVERSAL, Sterilisierzange .....	227
Titan-Arterienklemme, KELLY .....	106	Tränenkanaldilatator, CASTROVIEJO .....	381	UNIVERSAL, Trokar .....	204
Titan-Bulldogklemme .....	102	Tränenkanaldilatator, WILDER .....	381	UNIVERSAL, Verbandschere .....	70
Titan-Pinzette, DeBAKEY .....	99	Tränenkanaldilatator, ZIEGLER .....	381	Universalsgriff, HUBER .....	472
TOBOLD, Watteträger .....	203	Tränenkanalsonde, BOWMAN .....	381	Universelle Wundhakenhalterung f. Armsystem .....	188
TOBOLD, Zungendrucker .....	453	Tränensackdissektor, LANG .....	378	UNNA, Komedonenquetscher .....	608
TOENNIS, Arterienklemme .....	117	Tränensackhäkchen, KNAPP .....	375	Unterbindungsnadel .....	218
TOENNIS, Dura-Dissektor .....	332	Tränensackhäkchen, ROLLET .....	375	Unterbindungsnadel, COOPER .....	219
TOENNIS-ADSON, Schere .....	65	TRAVERS, Wundspreizer .....	172	Unterbindungsnadel, DESCHAMPS .....	218
TOHUKU, Tuchklemme .....	132	TRELAT, Scheidenspekula .....	571	Unterbindungsnadel, KRONECKER .....	219
Tonometer, SCHIOETZ .....	394/2	Trepine, KEYES .....	608	Unterbindungsnadel, NELSON .....	219
Tonsillennadel, CLAU .....	466	TROELTSCH, Nasenpinzette .....	424	Unterbindungsnadel, SCHMIEDEN-DICK .....	219
Tonsillennadel, CLAU-EICKEN .....	466	TROELTSCH, Ohrpinzette .....	410, 424	Unterkieferhaken, HARGIS .....	463, 463/6
Tonsillennadel, DUPUY-WEISS .....	466	TROEMNER, Perkussionshammer .....	24	Urethrotom, OTIS .....	553
Tonsillennadel, NAGER .....	466	Trokar, COAKLEY .....	204	US-ARMY, Wundhaken .....	141
Tonsillendissektor, HURD .....	465	Trokar, DOUGLAS .....	204	USA, anatomische Pinzette .....	81
Tonsillendissektor, LOPEZ-REINKE .....	465	Trokar, LICHTWITZ .....	204	USA Mod. Nabelschnurschere .....	64
Tonsillendissektor, YANKAUER .....	465	Trokar, NELSON .....	205	USA Modell, Verbindungskabel .....	633
Tonsillendraht .....	468	Trokar, OCHSNER .....	205	Uterusdilator, GOODELL .....	581
Tonsillenelevator, CARPENTER .....	465	Trokar, SINOSKOPIE .....	205	Uterusdilator, HANK .....	580
Tonsillenelevator, HENKE .....	465	Trokar, STANDARD (NELSON) .....	204	Uterusdilator, PRATT .....	580
Tonsillenfasspinzette, MARSCHIK .....	468	Trokar, UNIVERSAL .....	204	Uterusdilator, SIMS .....	581
Tonsillenfasszange, ABRAHAM .....	468	TROUSSEAU, Trachealdilatator .....	476	Uterusdilator, WYLIE .....	581
Tonsillenfasszange, BALLENGER .....	467	TROUSSEAU-BABY, Trachealdilatator .....	476	Uteruspolypenzange, DOYEN .....	585
Tonsillenfasszange, BLOHMKE .....	467	TROUTMAN, Irispinzette .....	384	Uteruspolypenzange, KELLY .....	585
Tonsillenfasszange, COLVER .....	467	TROUTMAN, Muskelpinzette .....	389	Uteruspolypenzange, NOTO .....	585
Tonsillenfasszange, MARSCHIK .....	468	TROUTMAN-CHRIS, Klingenbrecher .....	45	Uterus-Biopsiezange, ALEXANDER .....	589
Tonsillenfasszange, NEGUS .....	467	Tubenkatheter, SCHULTZE .....	596	Uterus-Biopsiezange, BABY-TISCHLER .....	592
Tonsillenfasszange, SAWELL .....	467	Tuchklemme .....	133	Uterus-Biopsiezange, BURKE .....	590
Tonsillenfasszange, SCHNIDT .....	467	Tuchklemme, BACKHAUS .....	132	Uterus-Biopsiezange, BURKE-BABY .....	590
Tonsillenfasszange, TYDING .....	468	Tuchklemme, BACKHAUS-CLIP .....	132	Uterus-Biopsiezange, EPPENDORFER .....	590
Tonsillenfasszange, WHITE .....	467	Tuchklemme, BALL AND SOCKET .....	133	Uterus-Biopsiezange, KEVORKIAN .....	589, 591
Tonsillennmesser, ABRAHAM .....	466	Tuchklemme, BERNHARD .....	133	Uterus-Biopsiezange, KEVORKIAN-PACIFIC .....	592
Tonsillennmesser, BRUENINGS .....	466	Tuchklemme, DOYEN .....	133	Uterus-Biopsiezange, MAXI GRASPER .....	593
Tonsillennmesser, CANFIELD .....	466	Tuchklemme, JONES .....	132	Uterus-Biopsiezange, MINI-TOWNSEND-DOWN .....	591
Tonsillennmesser, CARPENTER .....	465	Tuchklemme, JONES-CLIP .....	132	Uterus-Biopsiezange, MINI-TOWNSEND-UP .....	591
Tonsillennmesser, DOUGLAS .....	466	Tuchklemme, LANE .....	133	Uterus-Biopsiezange, SCHUMACHER .....	589
Tonsillennmesser, FISHER .....	466	Tuchklemme, LORNA .....	133	Uterus-Biopsiezange, TISCHLER-DOWN .....	591
Tonsillennadel .....	470	Tuchklemme, MOYNIHAN .....	133	Uterus-Biopsiezange, TISCHLER-KEVORKIAN .....	591
Tonsillenschere .....	59	Tuchklemme, PEERS .....	132	Uterus-Biopsiezange, TISCHLER-MORGEN .....	590, 591
Tonsillenschere, BOETTCHE .....	59	Tuchklemme, ROEDER .....	132	Uterus-Biopsiezange, TISCHLER-UP .....	591
Tonsillenschere, DEAN .....	59	Tuchklemme, SCHAEDEL .....	132	Uterus-Biopsiezange, TOWNSEND .....	591
Tonsillenschere, GOOD .....	59	Tuchklemme, TOHOKU .....	132	Uterus-Biopsiezange, WITTNER .....	589

Uterus-Depressor, BRAUN.....	586	WAGENER-MOSHER, Trachealkanüle.....	477	WOLFF, Gipsabreisszange.....	233
Uterus-Depressor, SIMS.....	586	WAGENSTEEN, Gefäßspinzette.....	89	WOODSON, Dura-Dissektor.....	333
Uterus-Dilatator, GOODELL.....	581	WAGNER, Laminektomiezange.....	343	WORST, Sonde.....	381
Uterus-Dilatator, HANK.....	580	WAGNER, SCHERE.....	67	WRIGLEY, Geburtszange.....	602
Uterus-Dilatator, HEGAR.....	578, 579	WAGNER, Supercutterschere.....	72	WULLSTEIN, Messer.....	418
Uterus-Dilatator, PRATT.....	580	WALDMANN, Episotomie-Schere.....	64	WULLSTEIN, Mikro-Löffelzangchen.....	416
Uterus-Dilatator, SIMS.....	581	WALSHAM, Septumrichtzange.....	449	WULLSTEIN, Mikro-Ohrzangchen.....	416
Uterus-Dilatator, WYLIE.....	581	WALTHER, Dilator-Katheter.....	555	WULLSTEIN, Sauggriff.....	338
Uterus-Fasszange, COLLIN.....	585	WALTON, Fingerringssäge.....	297	WULLSTEIN, Wundspreizer.....	171
Uterus-Fasszange, DARTIGUES.....	585	WALTON, Fremdkörperhohlmeißel.....	374	Wundhaken.....	463/3
Uterus-Fasszange, SOMER.....	585	WALTON, Komodonenquetscher.....	608	Wundhaken, ALM.....	168
Uterus-Kürette, BLAKE.....	595	Wangenhalter.....	453, 451	Wundhaken, ANDERSON.....	198
Uterus-Kürette, BUMM.....	597, 598	Wangenhalter, CAWOOD-MINNESOTA.....	451	Wundhaken, AUFRANC-COBRA.....	289
Uterus-Kürette, RECAMIER.....	597, 598	Wangenhalter, STERNBERG.....	453	Wundhaken, BREAST.....	198
Uterus-Kürette, SIMS.....	597, 598	WANGENSTEEN, Nadelhalter.....	210	Wundhaken, BRUNNER.....	167
Uterus-Kürette, THOMAS.....	599	WARTENBERG, Nervrädchen.....	25	Wundhaken, COLLIN.....	139
Uterus-Löffel, GOURDET.....	599	WATSON, Dermatome.....	50	Wundhaken, COLLIN-HARTMANN.....	141
Uterus-Löffel, SCHRÖDER.....	595	WATSON-CHEYNE, Elevator.....	283	Wundhaken, COOLEY.....	148
Uterus-Löffel, SIMON.....	594	WATSON-CHEYNE, Sonde.....	199	Wundhaken, CORONAL.....	198
Uterus-Sonde, COLLIN.....	586	WATSON-WILLIAMS, Nasenzange.....	428	Wundhaken, CORYLLOS.....	166
Uterus-Sonde, MARTIN.....	586	Wattedose.....	621	Wundhaken, CRILE.....	140
Uterus-Sonde, SIMS.....	586	Watteträger, FARRELL.....	203	Wundhaken, CUSHING.....	151- 153
Uterus-Sonde, VALLEIX.....	586	Watteträger, JOBSON-HORNE.....	203	Wundhaken, CZERNY.....	141
Uterus-Zange, GREEN-ARMYTAGE.....	605	Watteträger, REDA.....	203	Wundhaken, DAVIDSON.....	166
		Watteträger, TOBOLD.....	203	Wundhaken, DEAVER.....	145, 166
V.....		Watteträger, UCKERMANN.....	203	Wundhaken, DEAVER-GRIP.....	146
VALLEIX, Uterus-Sonde.....	586	WALLICH, Abortuslöffel.....	607	Wundhaken, DESMARRÉS.....	151
Valve, CASPAR, Cervicalspreizer.....	179, 180	WAUGH, chirurgische Pinzette.....	83	Wundhaken, DOYEN.....	163
Valve, CLOWARD, Cervicalspreizer.....	178/1 - 178/4	WEBER, Aortaklemme.....	501	Wundhaken, DOYEN-STILLE.....	167
Valve, Bauchdeckenhalter, BALFOUR.....	183	WEBER, Starschlinge.....	378	Wundhaken, FARABEU.....	139
Valve, Bauchdeckenhalter, HORGAN.....	183	WEBSTER, Nadelhalter.....	208	Wundhaken, FERRIERA.....	197
Valve, Scheidenspekula, O'SULLIVA-O'CONNOR.....	576	Wechselpinzette, Blätter.....	179	Wundhaken, FINSEN.....	168
VAN BUREN, Dilatationsbougie.....	554	WECKER, Augenschere.....	75	Wundhaken, FREEMAN.....	198
VAN BUREN, Knochenhaltezange.....	249	WECKER, Irisspatel.....	378	Wundhaken, FRITSCH.....	163
VAN DOREN, Biopsiezange.....	588	WEEK, Lidsperrerr.....	370	Wundhaken, GIL-VERNET.....	152
VANNAS, Augenschere.....	79	WEIL-BLAKESLEY, Nasenzange.....	426	Wundhaken, GOELET.....	141
VARADY, Varizeninstrument.....	202	WEITLANER, Wundspreizer.....	169	Wundhaken, GREEN.....	160
Varizeninstrument, VARADY.....	202	WEITLANER-WULLSTEIN, Wundspreizer.....	169	Wundhaken, HARGIS.....	463
Vasektomieklammer.....	553/1	WELLER, Präparierschere.....	53/2	Wundhaken, HARRINGTON.....	147
Verbandschere.....	70	WELLS, Eukleationslöffel.....	378	Wundhaken, HARRINGTON-PEMBERTON.....	147
Verbandschere, BERGMANN.....	69/1	WERTHEIM, gynäkologische Schere.....	62	Wundhaken, HASSON.....	143
Verbandschere, BRUNS.....	70	WERTHEIM, Hysterektomieklammer.....	124, 128	Wundhaken, HEANEY.....	164
Verbandschere, ESMARCH.....	69/2	WERTHEIM, Hysterektomieschere.....	63	Wundhaken, HIBBS.....	164
Verbandschere, KNOWLES.....	70	WERTHEIM-CULLEN, Nierenstielklammer.....	125	Wundhaken, HÖSEL.....	167
Verbandschere, LISTER.....	69/1	WEST, Hohlmeißel.....	442/1	Wundhaken, HOFER.....	465
Verbandschere, LORENZ.....	70	WEST, Nasenmeißel.....	442/1	Wundhaken, HOLZHEIMER.....	168
Verbandschere, REDA EXCENTER.....	69/2	WESTCOTT, Augenschere.....	75	Wundhaken, ISRAEL.....	162
Verbandschere, SEUTIN.....	69/2	WESTMACOTT, Nasentamponzange.....	424	Wundhaken, JANSEN.....	168
Verbandschere, SMITH US ARMY.....	69/1	WESTON, Rektalschnürer.....	566	Wundhaken, KELLY.....	164
Verbandschere, UNIVERSAL.....	70	WHEELER, Diszionsmesser.....	373	Wundhaken, KELLY-GRIP.....	142
Verbandstofftrommel, SCHIMMELBUSCH.....	622	WHEELER, Zyklodialespatel.....	379	Wundhaken, KLAPP.....	150
Verbindungskabel.....	633	WHITE, Tonsillenzange.....	467	Wundhaken, KÖNIG.....	153
VERBRUGGE, Knochenhaltezange.....	245	WIEDER, Zungendrücker.....	452	Wundhaken, KOCHER.....	155, 159, 160, 163
VERBRUGGE-MÜLLER, Knochenhebel.....	287	WIENER, Antrumraspel.....	443	Wundhaken, KOCHER-LANGENBECK.....	159
VERESS, Insufflationskanüle.....	206	WIENER, Irishäcken.....	375	Wundhaken, KOERTE.....	162
Verlängerungsrohr, BRUENINGS.....	472	WIGMORE, Gipsmesser.....	229	Wundhaken, LAHEY.....	157
Verlängerungsstück.....	299	WILSTROEM, Arterienklammer.....	117	Wundhaken, LANGENBECK.....	158, 159
Verstellbares Sägeblatt.....	230/7	WILDE, Polypenschnürer.....	411, 433/2	Wundhaken, LANGENBECK-GREEN.....	153
VIENNA, Führungshohlsonde.....	221/1	WILDE (TROELTSCH), Ohrpinzette.....	410	Wundhaken, LITTLE.....	157
VIRCHOEW, Seziermesser.....	48	WILDER, Starschlinge.....	378	Wundhaken, LOVE.....	465
VIRTUS (RALK), Splitterzange.....	92	WILDER, Tränenkanal-Dilatator.....	381	Wundhaken, LUER.....	140
VOLKMANN, Doppellöffel.....	257	WILLET-MARTEL, Fasszange.....	110	Wundhaken, MATHIEU.....	141
VOLKMANN, Knochenhaken.....	156	WILLIAMS, Darmfasszange.....	539	Wundhaken, MIDDELDORPF.....	160
VOLKMANN, scharfer Löffel.....	251, 257	WILLIAMS, Lidsperrerr.....	370	Wundhaken, MIKULICZ.....	163
VOLKMANN, Wundhaken.....	153, 154, 156	WILLIAMS, Schraubenzieher.....	323	Wundhaken, MEYERDING.....	177
VOLTOLINI, Nasenspekula.....	421	WILLIGER, Hammer.....	271	Wundhaken, MORRIS.....	164
Vorböhrer, KUENTSCHER.....	321	WILLIGER, Raspator.....	276	Wundhaken, MURPHY.....	156
VU-MORE, Scheidenspekula.....	569	WILLIGER, scharfer Löffel.....	255, 257	Wundhaken, NAGER.....	465
		Winkelmesser, MOELTGEN.....	25	Wundhaken, OBWEGESER.....	460, 461/1
W.....		WINTER, Abortuszange.....	606	Wundhaken, OLLIER.....	162
WACHENFELDT, Wundklammerpinzette.....	224	Wirbelkörperspreizer, CLOWARD.....	339	Wundhaken, PARKER.....	139
WADSWORTH-TODD, Cauter.....	378	Wirbelkörperspreizer, INGE.....	339	Wundhaken, RAGNELL.....	140
WAGENER, Häkchen.....	409	WITTNER, Uterus-Biopsiezange.....	589	Wundhaken, RAMUS.....	461

Wundhaken, RICHARDSON.....	142	YASARGIL, SAUGROHR.....	337/1	Zange, WITTNER.....	589
Wundhaken, RICHARDSON-GRIP.....	142	YASARGIL, Spannam.....	368/2	Zange, YEOMANN.....	567
Wundhaken, RICHARDSON-EASTMAN.....	142	YASARGIL, Tumorzinzette.....	97	ZAUFAL, Ohrhebel.....	409
Wundhaken, ROSE.....	140	YASARGIL, Mastdarm-Biopsiezange.....	566, 567	ZAUFAL-JANSEN, Hohlmeisselzange.....	238
Wundhaken, ROSS.....	148/1	YOUNG, Prostatahaken.....	550	ZAUFAL-JANSEN, Ohrhebel.....	409
Wundhaken, ROUX.....	139	YOUNG, Zungenzange.....	453	ZEIGLER, Lidsperrer.....	371
Wundhaken, ROUX-BABY.....	140	YOUNG-BOOMERANG, Nadel.....	220	ZENKER, Arterienklemme.....	118
Wundhaken, ROUX-Mini.....	140			ZENKER, Wundhaken.....	161
Wundhaken, SAUERBRUCH.....	164, 166	Z		Zerlegbare Stanze, FERRIS-SMITH-KERRISON.....	344/2
Wundhaken, SENN-GREEN.....	153	Zahnfleischschere, GOLDMAN-FOX.....	67	ZEIGLER, Disziionsmesser.....	373
Wundhaken, SENN-MILLER.....	143	Zahnfleischschere, LA GRANGE.....	69, 72	ZIEGLER, Irismesser.....	372
Wundhaken, SIMON.....	164	Zahnfleischschere, LOCKLIN.....	69	ZIEGLER, Stirnspiegel.....	21
Wundhaken, SPINA-NASALIS.....	461	Zahnfleischschere, QUINBY.....	67	ZIEGLER, Tränenkanal-Dilatator.....	381
Wundhaken, St. MARKS.....	165	Zahnpinzette, LONDON-COLLEGE.....	93	ZIELKE, Hohlmeissel.....	264
Wundhaken, STRANDELL-STILLE.....	157	Zahnpinzette, MERIAM.....	93	Zirkular-Stanze.....	432
Wundhaken, TEBBETTS.....	197	Zange, ADAIR.....	582	ZÖLLNER, Saugrohr.....	337/1
Wundhaken, TUFFIER.....	147	Zange, ALEXANDER.....	589	Zubehör f. Autopsiesäge.....	230/1 - 230/9
Wundhaken, US-ARMY/PARKER-LANGENBECK.....	141	Zange, ASCH.....	449	Zubehör f. oszillierende Gipssäge.....	230/11, 230/13
Wundhaken, VOLKMANN.....	153, 154, 156	Zange, BABY-TISCHLER.....	592	Zubehör f. Staubsauger u. Anlage.....	231/1
Wundhaken, YANCOSKIE.....	198	Zange, BARRETT.....	582	Zughaken, KIRSCHNER.....	313
Wundhaken, ZENKER.....	161	Zange, BLAKE.....	530/2	Zughebel, BARTON.....	603/2
Wundhakenhalterung.....	188	Zange, BRAUN.....	582	Zughebel, BILL.....	604
Wundklammern, MICHEL.....	224	Zange, BURKE.....	590	Zughebel, LUIKART-BILL.....	604
Wundklammerpinzette, HEGENBARTH.....	224	Zange, CHEVALIER-JACKSON.....	473	Zugsseil, NABATOFF.....	201
Wundklammerpinzette, MICHEL.....	224	Zange, COLLIN.....	585	Zungendrucker, ANDREW.....	452
Wundklammerpinzette, WACHENFELDT.....	224	Zange, CZERNY.....	584	Zungendrucker, DAVIS-BOYLE.....	455
Wundklammerzange, CHILDE.....	224	Zange, DARTIGUES.....	585	Zungendrucker, DINGMANN.....	456
Wundklammerzange, COLLIN.....	224	Zange, DESJARDINS.....	530/2	Zungendrucker, HARTMANN.....	452
Wundklammerzange, MICHEL.....	224	Zange, DOYEN.....	585	Zungendrucker, KILNER-DOUGHTY.....	456
Wundklammerzange, RICHTER-HEATH.....	224	Zange, DUPLAY.....	582	Zungendrucker, MORITZ-SCHMIDT.....	452
Wundlöffel, ARRUGA.....	378	Zange, EPPENDORFER.....	590	Zungendrucker, TOBOLD.....	453
Wundnahtbesteck.....	225, 226	Zange, FAURE.....	588	Zungendrucker, WIEDER.....	452
Wundsperrer, ALM.....	168	Zange, GAUSS.....	605	Zungenspatel.....	451
Wundsperrer, CLOWARD.....	178/1 - 178/4	Zange, GREEN-ARMYTAGES.....	605	Zungenspatel, BRUENINGS.....	451
Wundsperrer, FINSEN.....	168	Zange, HEIMING.....	536	Zungenspatel, BUCHWALD.....	451
Wundsperrer, GELPI.....	189/2	Zange, HEYWOOD-SMITH.....	567	Zungenspatel, DOUGHTY.....	458
Wundsperrer, HOLZHEIMER.....	168	Zange, HULKA.....	583	Zungenspatel, FRENZEL.....	451
Wundsperrer, JACKSON-BURROWS.....	189/2	Zange, IOWA.....	584	Zungenspatel, KROENIG.....	451
Wundsperrer, JANSEN.....	168	Zange, JACOBS.....	583	Zungenspatel, MAYO.....	451
Wundsperrer, RIGBY.....	189/2	Zange, JARCHO.....	583	Zungenspatel, MORITZ-SCHMIDT.....	452
Wundspreizer, ADSON.....	172 - 174	Zange, JURASZ.....	471	Zungenspatel, RING.....	455
Wundspreizer, ADSON-BABY.....	173	Zange, KELLY.....	585	Zungenspatel, RUSSEL-DAVIS.....	458
Wundspreizer, ANDERSON-ADSON.....	172	Zange, KEVORKIAN.....	589, 592	Zungenzange, COLLIN.....	453
Wundspreizer, BECKMANN.....	176	Zange, KEVORKIAN-PACIFIC.....	592	Zungenzange, YOUNG.....	453
Wundspreizer, BECKMANN-ADSON.....	175	Zange, MATHIEU.....	553/1	Zwischenknochen-Messer.....	44
Wundspreizer, BECKMANN-EATON.....	176	Zange, MAYO-BLAKES.....	530/2	Zwischenstück, SCHULTZE Salpingograph.....	596
Wundspreizer, BOSE.....	476	Zange, MAXI GRASPER.....	593	Zyklodialysespatel, BANGERTER.....	379
Wundspreizer, CASPAR.....	180	Zange, MIXTER.....	530/2	Zyklodialysespatel, CASTROVIEJO.....	379
Wundspreizer, DARLING.....	178	Zange, MUSEUX.....	583	Zyklodialysespatel, ELSCHNIG.....	379
Wundspreizer, HENLEY.....	170	Zange, NOTO.....	585	Zyklodialysespatel, HIRSCHMANN.....	379
Wundspreizer, MARTIN.....	175/1	Zange, POZZI-PALMER.....	582	Zyklodialysespatel, WHEELER.....	379
Wundspreizer, MAYO-ADAMS.....	171	Zange, PRATT.....	584		
Wundspreizer, MEYERDING.....	180	Zange, RANDALL.....	535		
Wundspreizer, MOLLISON.....	171	Zange, REDA.....	474		
Wundspreizer, NORFOLK/NORWICH.....	172	Zange, ROWE.....	459		
Wundspreizer, PERKINS.....	168	Zange, SAENGER.....	606		
Wundspreizer, PLESTER.....	171	Zange, SCHRÖDER.....	584		
Wundspreizer, SCALP-CONTOUR.....	169	Zange, SCHRÖDER (POZZI).....	582		
Wundspreizer, TRAVERS.....	172	Zange, SCHUBERT.....	588		
Wundspreizer, WEITLANER.....	169	Zange, SCHUMACHER.....	588, 589		
Wundspreizer, WEITLANER-WULLSTEIN.....	169	Zange, SERPENTINE GRASPER.....	593		
Wundspreizer, WULLSTEIN.....	169, 171	Zange, SKENE.....	582		
WYLIE, Aortaklemme.....	501/1	Zange, SMITH.....	463		
WYLIE, Uterus-Dilatator.....	581	Zange, SOMER.....	585		
		Zange, TEALE.....	583		
		Zange, THOMAS-GAYLOR.....	588		
Y		Zange, TISCHLER-KEVORKIAN.....	592		
YANCOSKIE, Wundhaken.....	198	Zange, TISCHLER-MORGAN.....	590		
YANKAUER, Saugrohr.....	27	Zange, TOWNSEND.....	591		
YANKAUER, Tonsillen-Dissektor.....	465	Zange, TURREL.....	567		
YASARGIL, Gefäßclip.....	349 - 356	Zange, Van DOREN.....	588		
YASARGIL, Galeahaken.....	330	Zange, WALSHAM.....	449		
YASARGIL, Hirnspatelhalter.....	368	Zange, WINTER.....	606		
YASARGIL, Ohrspekulahalter.....	368/2				



abdominal- a. intestinal spatula KÜMMEL.....	143/4, 144	amputation saw SATTERLEE.....	296	atraumatic forceps COOLEY.....	99
abdominal retractor KIRSCHNER.....	187, 187/1	Anal retractor SMITH-BUIE.....	561	atraumatic tissue forceps DEBAKEY.....	99
abdominal retractors BABY GOSSET.....	181	anastomosis clamp BECK.....	516	AUFRANC retractor.....	289
abdominal retractors BALFOUR.....	182	anastomosis clamp BECK.....	520	AUFRIEHT nose hook.....	447
abdominal retractors BALFOUR Baby.....	182	anastomosis clamp COOLEY.....	519, 520 - 520/4	AUFRIEHT nose rasp.....	443
abdominal retractors BALFOUR-US.....	184	anastomosis clamp COOLEY-DERRA.....	519	Auricle clamp HARKEN.....	503
abdominal retractors CHARNLEY.....	289	anastomosis clamp DE MARTEL-WOLFSON.....	546	autopsy knife.....	48
abdominal retractors COLLIN.....	190	anastomosis clamp DEBAKEY.....	505	autopsy saw and accessories.....	230 - 230/9
abdominal retractors COLLIN-LOKTITE.....	191	anastomosis clamp LAMBERT-KAY.....	505	AUVARD vaginal specula.....	576
abdominal retractors DENIS-BROWNE.....	185	anatomic tissue forceps BROPHY.....	84	awl.....	304
abdominal retractors DOYEN.....	189/1	anatomic tissue forceps.....	81	awl HARGIS.....	463
abdominal retractors FRAZIER.....	181	anatomic tissue forceps ADSON.....	81/2	Awl OBWEGESER.....	463
abdominal retractors GELPI.....	189/1, 189/2	anatomic tissue forceps ADSON Micro.....	81/2	awl PERTHES.....	304
abdominal retractors GOSSET.....	181	anatomic tissue forceps BONNEY.....	88	AXENFELD chalazio curette.....	377
abdominal retractors KIRSCHNER.....	185, 187	anatomic tissue forceps CUSHING.....	83	AYER chalazio tissue forceps.....	393
abdominal retractors RICARD.....	191	anatomic tissue forceps CUSHING-TAYLOR.....	87		
abdominal retractors RIGBY.....	189/2	anatomic tissue forceps DUEHRSEN.....	84	<b>B</b>	
abdominal retractors ROCHARD.....	186	anatomic tissue forceps GERALD.....	86	BABCOCK intestinal grasping forceps.....	539
abdominal spatula KADER.....	143/3	anatomic tissue forceps McINDOE.....	85	BABINSKI percussion mallet.....	24
abdominal spatula KOERTE.....	143/3	anatomic tissue forceps POTTS-SMITH.....	81	BABY BURKE biopsy forceps.....	590
abdominal spatula Leriche.....	143/4	anatomic tissue forceps SEMKEN.....	86	BABY GOSSET abdominal retractor.....	181
ABLI ophthalmologic scissors.....	58	anatomic tissue forceps TAYLOR.....	87	BABY METZENBAUM supercut scissors.....	71
ABRAHAM tonsil forceps.....	468	anatomic tissue forceps TC.....	81	BABY TISCHLER rongeur.....	592
ABRAHAM tonsil knives.....	466	anatomic tissue forceps type USA.....	81	BABY WEBSTER needle holder.....	208
accessories for autopsy saw.....	231/3	anatomic tissue forceps STILLE.....	81	BABY YANKAUER suction tube.....	27
ADAIR tenaculum forceps.....	582	ANDERSON ADSON retractors.....	172	BABY-KOCHER intestinal clamp.....	540
adenoid curette BARNHILL.....	450	ANDERSON retractor.....	198	BABY-OLSEN-HEGAR needle holder.....	212
adenoid curette BECKMANN.....	450	ANDREW tongue depressor.....	452	BABYPHON Sphygmomanometer.....	10
adenoid curette St. CLAIR-THOMSON.....	450	ANDREW-PYNCHON suction tube.....	28	Back holder Abdominal retractor system.....	192, 193, 194, 195
Adenotom LA FORCE.....	450	ANESTOPHON.....	23	BACKHAUS towel clamp.....	132
ADLERKREUTZ vascular tissue forceps.....	84	aneurysm clamp DEBAKEY-BAHNSON.....	506	BACKHAUS-clip.....	132
ADSON retractors.....	173	aneurysm clip applicator forceps.....	357 - 360	BAILEY rib spreader.....	489/1
ADSON anatomic tissue forceps.....	81/2	aneurysm vascular clip YASARGIL.....	349 - 356	BAILEY-BABY rib spreader.....	489/1
ADSON anatomic tissue forceps.....	81/2	anoscope HIRSCHMANN.....	562	BAILEY-GIBBON rib spreader.....	489/1
ADSON BABY hemostatic clamp.....	113	anoscope IVES-FANSLER.....	562	BAINBRIDGE hemostatic clamp.....	120
ADSON bone rongeur.....	236	Antrum curette COAKLEY.....	449	BAINBRIDGE vascular clamp.....	495/1, 495/2
ADSON dura hook.....	328	Antrum rasp GALLAHER.....	446	BAKES gall duct dilator.....	532
ADSON hemostatic clamp.....	112	Antrum rasp LEWIS.....	443	BALFOUR abdominal retractors.....	182
ADSON holding clamp.....	298	ANTRUM-curette.....	435	BALFOUR AND SOCKET towel clamp.....	133
ADSON hypophyseal forceps.....	334	ANVIL nail forceps.....	613	ball electrode MONOPOLAR.....	628, 629
ADSON MICRO anatomic tissue forceps.....	81/2	aorta clamp WEBER.....	501	BALLENGER knives.....	436
ADSON MICRO surgical tissue forceps.....	81/2	aorta punch.....	528	BALLENGER septum elevator.....	439
ADSON needle holder.....	211	aortic clamp WYLIE.....	501/1, 501/2	BALLENGER tonsil forceps.....	467
ADSON raspatories.....	282	appendix clamp ALLEN.....	544	bandage scissors.....	70
ADSON retractors.....	172, 173, 174	appendix clamp KLEINSCHMIDT.....	544	bandage scissors BERGMANN.....	69/1
ADSON suction tube.....	337	applier forceps aneurysm clip.....	357 - 360	bandage scissors BRUNS.....	70
ADSON surgical tissue forceps.....	81/2	applier forceps BIEMER.....	361, 366	bandage scissors ESMARCH.....	69/2
ADSON-BROWN tissue forceps.....	82	applier forceps JOHNS-HOPKINS.....	104	bandage scissors KNOWLES.....	70
ADSON-DEBAKEY atraumatic forceps.....	81/2	applier forceps MC KENZIE.....	326	bandage scissors LISTER.....	69/1
air blower.....	405	applier forceps MEHDORN.....	362	bandage scissors LORENZ.....	70
air blower POLITZER.....	406	applier forceps SMITHWICK.....	326	bandage scissors REDA EXCENTER.....	69/2
AIR INJECTION eye cannula.....	394	applier forceps SWEET.....	326	bandage scissors SEUTIN.....	69/2
air pump.....	295	appling forceps RANEY.....	327	bandage scissors SMITH US army.....	69/1
ALAN-PARKS rectal specula.....	561	Approximator BIEMER.....	366	bandage scissors UNIVERSAL.....	70
ALLDERDYCE elevator.....	282	Approximator BIEMER-MÜLLER.....	363	BANE-HARTMANN bone rongeur.....	237
ALEXANDER biopsy forceps.....	589	Approximator MÜLLER.....	364	BANGERTER cyclodialysis spatula.....	379
ALEXANDER chisels.....	259	ARCHER splinterforceps.....	92	BARACANI interchangeable tips.....	472
ALEXANDER raspatories.....	276	ARLT cataract loop.....	378	BARANY air blower.....	405
ALLEN appendix intestinal clamp.....	544	armsystem.....	188	BARBARA hook.....	419
ALLIS intestinal grasping forceps.....	537	ARRUGA capsular forceps.....	391	BARBARA needle.....	419
ALLIS-ADAIR intestinal grasping forceps.....	537	ARRUGA extraction hook.....	375	BARKAN goniotomy knives.....	373
ALLIS-BABY intestinal grasping forceps.....	537	ARRUGA eye specula.....	370	BARNHILL adenoid curette.....	450
ALLISON lung spatula.....	489/2	ARRUGA needle holder.....	214	BARON scution tube.....	336
ALM retractor.....	168	ARRUGA wound curette.....	378	BARR rectal-specula.....	559
ALVIS foreign body curette.....	374	ASCH septum straightening forceps.....	449	BARRAQUER cilia forceps.....	395
amnioscope.....	601	atrauma bulldog clamp.....	100	BARRAQUER eye scissors.....	75
amniotome BEACHAM.....	586	Atrauma bulldog clamp.....	100, 102	BARRAQUER eye specula.....	370
amputation knives CATLIN.....	44	atrauma clamp DEBAKEY.....	100	BARRAQUER eye specula.....	370
amputation knives LANGENBECK.....	44	atrauma clamp DEBAKEY.....	103	BARRAQUER fixation forceps.....	390
amputation knives LISTON.....	44	atrauma clamp GLOVER.....	100	BARRAQUER knives.....	373
amputation knives REDA.....	44	atrauma neonatal clamp.....	523		
amputation saw BIER.....	296	Atrauma-neonatal clamp GLOVER.....	103		
amputation saw CHARRIERE.....	296	atraumatic forceps ADSON-DEBAKEY.....	81/2		

BARRAQUER needle holder.....	217	Bipolar-tissue forceps bajonett.....	632	bone holding forceps FARABEUF.....	243
BARRAQUER needle holder.....	216, 217	BIRCHER-GANSKE bone holding forceps.....	246	bone holding forceps FARABEUF-LAMBOTTE.....	243
BARRAQUER-KATZIN iris tissue forceps.....	384	BIRKETT hemostatic clamp.....	116	bone holding forceps FERGUSSON.....	243
BARRET hook forceps.....	582	BISHOP-HarmAN iris tissue forceps.....	386	bone holding forceps KERN.....	244
BARTON obstetrical forceps.....	603/2	BISHOP-HarmAN irrigation cannula.....	394/1	bone holding forceps LAMBOTTE.....	244
battery handle for cold light.....	33	bladder retractors LEGUE.....	553	bone holding forceps LANE.....	244
battery handle for warm light.....	32	bladder retractors MILLIN.....	552	bone holding forceps LANGENBECK.....	243
BAUMGARTNER needle holder.....	208	bladder retractors THOMSON-WALKER.....	552	bone holding forceps LEWIN.....	246
BEAGHAM amniotome.....	586	bladder retractorsJUDD-MASSON.....	552	bone holding forceps MEYER.....	248
BECHERT Nucleus Rotator.....	379	bladder spatula KOCHER.....	552	bone holding forceps REDA.....	246, 247
BECK anastomosis clamp.....	520	bladder spatula LEGUEU.....	552	bone holding forceps REILL.....	248
BECK vascular clamp.....	516	bladder spreader MILLIN.....	553	bone holding forceps SEMB.....	243
BECKER cystotome.....	375	blade breaker CASTROVIEJO.....	45	bone holding forceps ULRICH.....	248
BECKMANN adenoid curette.....	450	blade breaker REDA.....	45	bone holding forceps VAN BUREN.....	249
BECKMANN retractors.....	176	blade breaker TROUTMAN-CHRIS.....	45	bone holding forceps VERBRUGGE.....	245
BECKMANN-ADSON retractors.....	175	blade ejecting forceps.....	179	bone hook VOLKMANN.....	156
BECKMANN-EATON retractors.....	176	blade remover.....	42	bone levers.....	284, 288
bed pan.....	621/1	blade scalpel.....	42	bone levers BENNETT.....	283
BEEBEE crown scissors.....	68	blades razor.....	45	bone levers BLOUNT.....	288
BEER cilia forceps.....	395	BLAKE gall stone forceps.....	530/2	bone levers HOHMANN.....	284
BEESON plaster retractor.....	232	BLAKE uterine curette.....	595	bone levers HOHMANN.....	285
BELLUCCI micro ear scissors.....	413	BLOHMKE tonsil forceps.....	467	bone levers HOHMANN Mini.....	286
BELLUCCI micro scissors.....	417	blood vessel clamp DIETRICH.....	510	bone levers KOENIG.....	284
bender LANE.....	322/1	blood vessel clamp MORRIS-DEBAKEY.....	506	bone levers LANGE-HOHMANN.....	286
bender LANE.....	325	BLOUNT bone levers.....	288, 289	bone levers SMILLIE.....	291
BENGOLEA hemostatic clamp.....	112	blower KABIERSKE.....	405	bone levers VERBRUGGE-MÜLLER.....	287
BENNETT bone levers.....	283	BLUMENTHAL bone rongeur.....	236	bone plate holding forceps LANE.....	325
BENSAUDE proctoscope.....	565	BODENmallet rectal specula.....	559	bone rasp.....	294
BENSON pylorus retractor.....	544	BOEHLER extension bow.....	312	bone rasp PUTTI.....	294
BERENS discision knives.....	372	BOERMA obstetrical forceps.....	604	bone rongeur rLEKSELL-STILLE.....	240
BERGMANN bandage scissors.....	69/1	BOETTCHER tonsil scissors.....	59	bone rongeur ADSON.....	236
BERGMANN mallet.....	272	BÖHLER bone cutting forceps.....	241	bone rongeur BANE-HARTMANN.....	237
BERKE muscle forceps.....	389	BÖHLER bone rongeur.....	238	bone rongeur BEYER.....	237, 238
BERLINER percussion mallet.....	24	BOIES elevator.....	277	bone rongeur BLUMENTHAL.....	236
BERNHARD towel clamp.....	133	BONACCOLTO strabismus forceps.....	385	bone rongeur BOEHLER.....	238
BERRY wire forceps.....	319	bone curettes.....	255, 256	bone rongeur CLEVELAND.....	235
BETHUNE rib scissors.....	481	bone curettes BRUNS.....	251, 254	bone rongeur ECHLIN.....	240
BEYER bone rongeur.....	237, 238	bone curettes BUSHE.....	256	bone rongeur FRIEDMAN-MICRO.....	234
BIEMER applier forceps.....	361, 366	bone curettes DAUBENSPECK.....	255	bone rongeur FRIEDMAN-MINI.....	234
BIEMER approximator.....	366	bone curettes HALLE.....	253	bone rongeur FRYKHOLM.....	240
BIEMER vascular clip.....	361	bone curettes JACOBSON.....	257	bone rongeur JANSEN.....	237
BIEMER-MÜLLER approximator.....	363	bone curettes JANSEN.....	257	bone rongeur KLEINERT-KUTZ.....	237
BIER amputation saw.....	296	bone curettes LEMPERT.....	256	bone rongeur LEMPERT.....	237
BILLEAU ear loop.....	409	bone curettes MARTINI.....	257	bone rongeur LUER.....	236
biopsy curette HEANY.....	587	bone curettes SCHEDE.....	251	bone rongeur MARQUARD.....	239
biopsy curette KEVORKIAN.....	587	bone curettes SCOVILLE.....	253	bone rongeur MAYFIELD.....	238
biopsy curette NOVAK.....	587	bone curettes SPINAL.....	253	bone rongeur MEAD.....	235
biopsy curette RANDALL.....	587	bone curettes SPRATT.....	251	bone rongeur OLIVECRONA.....	237
biopsy curette type MÜNCHEN.....	587	bone curettes VOLKMANN.....	251, 257	bone rongeur RUskin.....	239
biopsy forceps ALEXANDER.....	589	bone curettes WILLIGER.....	255, 257	bone rongeur SAUERBRUCH.....	240
biopsy forceps BABY BURKE.....	590	bone cutting forceps BOEHLER.....	241	bone rongeur SCAGLIETTI.....	240
biopsy forceps BURKE.....	590	bone cutting forceps COTTLE-KAZANJIAN.....	241	bone rongeur SEMB.....	240
biopsy forceps EPPENDORFER.....	590	bone cutting forceps LISTON.....	241	bone rongeur SMITH-PETERSEN.....	238
biopsy forceps FAURE.....	588	bone cutting forceps McINDOE.....	241	bone rongeur STELLBRINK.....	234
biopsy forceps KEVORKIAN.....	589	bone cutting forceps RUskin.....	241	bone rongeur STILLE-LUER.....	239
biopsy forceps KEVORKIAN.....	591	bone cutting forceps SEMB.....	242	bone rongeur STILLE-RUskin.....	239
biopsy forceps KEVORKIAN-PACIFIC.....	592	bone cutting forceps STILLE-HORSLEY.....	242	bone rongeur ZAUFAL-JANSEN.....	238
biopsy forceps MAXI GRASPER.....	593	bone cutting forceps STILLE-LISTON.....	242	bone wire soft.....	314
biopsy forceps SCHUBERT.....	588	bone hand drills BUNELL.....	299	BONNI iris tissue forceps.....	387
biopsy forceps SCHUMACHER.....	588, 589	bone hand drills HUDSON.....	299	BONNEY anatomic tissue forceps.....	88
biopsy forceps THOMAS-GAYLOR.....	588	bone hand drills KIRSCHNER.....	299	BONNEY surgical tissue forceps.....	88
biopsy forceps TISCHLER-DOWN.....	591	bone hand drills MOORE.....	298	BOSE trachea hook.....	476, 477
biopsy forceps TISCHLER-KEVORKIAN.....	592	bone hand drills RALK.....	300	BOUCHERON ear specula.....	399
biopsy forceps TISCHLER-MORGAN.....	591	bone hand drillsSTILLE.....	298	BOWMAN discision needle gerade.....	374
biopsy forceps TOWNSEND MINI.....	591	bone hand drillsSTILLE-SHERMAN.....	298	BOWMAN eye specula.....	370
biopsy forceps TOWNSEND TISCHLER MINI.....	591	bone holding clamp FELDHEIM.....	249	BOWMAN lachrymal probes.....	381
biopsy forceps VAN DOREN.....	588	bone holding clamp GERSTER.....	250	Box PETRI.....	620
biopsy forceps WITTNER.....	589	bone holding clamp LAMBERT-LOWMAN.....	249	BOYNTON needle holder.....	214
biopsy forcepsTISCHLER-MORGAN.....	590	bone holding clamp LOWMAN.....	249	BOZEMANN dressing forceps.....	138
biopsy needle MENGHINI.....	206	bone holding clamp LOWMAN-HOGLUND.....	249	BOZEMANN needle holder.....	211
biopsy-/suction curette.....	600	bone holding forceps.....	249	BOZEMANN-DOUGLAS dressing forceps.....	138
bipolar cable.....	633	bone holding forceps BIRCHER-GANSKE.....	246	brain knives.....	48
bipolar tissue forceps.....	630, 631	bone holding forceps DINGMANN.....	246	brain spatula CUSHING.....	336

brain spatula CUSHING.....	369	capsular forceps CASTROVIEJO.....	391	chisels COTTLE.....	440
brain spatula DAVIS.....	337	capsular forceps ELSCHNIG.....	391	chisels HIBBS.....	265
brain spatula HEIFETZ.....	369	capsular forceps FUCHS.....	391	chisels HOKE.....	265
brain spatula OLIVECRONA.....	336	capsular forceps GILL-ARRUGA.....	390	chisels Killian.....	442/1
BRAND tendon grasping instrument.....	293	capsular forceps HESS.....	391	chisels LAMBOTTE.....	261
BRAND tendon passing instrument.....	294	capsular forceps KALT.....	391	chisels LEXER.....	263
BRAUN cranoplast.....	607	capsular forceps SCHWEIGGER.....	391	chisels MINI-LAMBOTTE.....	262
BRAUN decapitating hook.....	607	capsular forceps TERSON.....	391	chisels NOVOTEX.....	264
BRAUN hook forceps.....	582	capsular grasping forceps MILLIN.....	551	chisels OBWEGESER.....	463
BRAUN uterine-Depressor.....	586	cardiovascular clamps.....	526	chisels SMITH-PETERSEN.....	261
BRAUN-STADLER episotomy scissors.....	64	CarmALT splinter tissue forceps.....	91	chisels STILLE.....	260
BREAST retractor.....	198	CAROLL tendon grasping instrument.....	293	cilia forceps BARRAQUER.....	395
BREISKY vaginal specula.....	577	Carotid shunt clamp JAVID.....	511	cilia forceps BEER.....	395
BRIDGE hemostatic clamp.....	116	CARPENTER tonsil knives.....	465	cilia forceps DOUGLAS.....	395
BRISTOW bone levers.....	290	CARTILAGE knives.....	47	cilia forceps GRADLE.....	395
BRODIE probes.....	199	CASPAR hemostats.....	258	cilia forceps LITTAUER.....	395
Broncho forceps CHEVALIER-JACK.....	473	CASPAR retractors.....	179, 180	cilia forceps REDA.....	395
bronchus clamp.....	126	CASTANEDA Neonatal vascular clamp.....	527	CINELLI septum chisels.....	441
bronchus clamp FINOCCHIETTO.....	490	CASTROVIEJO.....	79, 381	circular rongeur.....	432
bronchus clamp HARRINGTON.....	490	CASTROVIEJO bladeBREAKER.....	45	CIRCUMCISIONS instrument.....	556
bronchus clamp LEES.....	504	CASTROVIEJO capsular forceps.....	391	CITELLI rongeur.....	430
bronchus clamp PRICE-THOMAS.....	490	CASTROVIEJO cyclodialysis spatula.....	379	clamp socket.....	189
bronchus clamp SEMB.....	491	CASTROVIEJO discision knives.....	372	clamp Vasktomie.....	553/2
BROPHY anatomic tissue forceps.....	84	CASTROVIEJO eye specula.....	371	CLAR HEAD LIGHTS.....	22
BROPHY surgical tissue forceps.....	84	CASTROVIEJO fixation forceps.....	390	CLARK eye specula.....	370
BROWN needle holder.....	209	CASTROVIEJO hornyskincissors.....	79	CLAUS tonsil needle.....	466
BROWN tissue forceps.....	83	CASTROVIEJO Measurance circle.....	380	CLAYMAN.....	376
BRUENINGS ear specula.....	401	CASTROVIEJO needle holder.....	215	Clayman hook.....	376
BRUENINGS interchangeable tips.....	472	CASTROVIEJO tissue forceps.....	392	cleaning pistol.....	626
BRUENINGS septum forceps.....	425	CASTROVIEJO-MICRO needle holder.....	215	CLEVELAND bone rongeur.....	235
BRUENINGS tongue depressors.....	451	CASTROVIEJO-STANDARD needle holder.....	216	clip forceps CHILDE.....	224
BRUENINGS tonsil knives.....	466	cataract curette DAVIEL.....	377	clip forceps COLLIN.....	224
BRUENINGS tonsil snare.....	468	cataract curette GRAEFE.....	377	clip forceps MICHEL.....	224
BRUNETTI chisels.....	268	cataract curette KNAPP.....	378	clip forcepsRICHTER-Heath.....	224
BRÜNINGS-LUCAS chisels.....	260	cataract knives DEUTSCHMANN.....	371	clip MICHEL.....	224
BRUNNER guideprobes.....	221/1	cataract knives GRAEFE.....	371	clip tissue forceps HEGENBARTH.....	224
BRUNNER intestinal clamp.....	543	cataract loop ARLT.....	378	clip tissue forceps MICHEL.....	224
BRUNNER retractor.....	167	cataract loop SNELLEN.....	378	clip tissue forceps WACHENFELDT.....	224
BRUNNER rib scissors.....	481	cataract loop WEBER.....	378	clip-applier forceps.....	523, 524
BRUNS bandage scissors.....	70	cataract loop WILDER.....	378	CLOWARD lamina spreader.....	339
BRUNS bone curettes.....	251, 254	CATHER INTRODUCING FORCEPS MAGILL.....	28	CLOWARD laminectomy retractor forceps.....	342
brush dispenser.....	611	catheter forceps COOLEY.....	510	CLOWARD retractors.....	178/1, 178/2, 178/3, 178/4
BRYANT dressing forceps.....	137	catheter guide GUYON.....	554	COAKLEY ANTRUM curette.....	449
BUCHWALD tongue depressors.....	451	catheter WALTHER.....	555	COAKLEY trocar.....	204
BUCK ear curette.....	407	CATLIN amputation knives.....	44	COBB curette.....	252
BUCK foreign body lever.....	412	cauter WADSWORTH-TODD.....	378	COBB gouges.....	262
BUCK percussion mallet.....	24	cervica retractor CLOWARD.....	178/1, 178/2, 178/3, 178/4	COBB raspatories.....	280
BUCK-GRAMCKO bone levers.....	285	cervical traction tong CRUTCHFIELD.....	327	COLCLOUGH intervertebral disc rongeur.....	344/1
BUJE rectal suction tube.....	566	chalazio curette AXENFELD.....	377	COLD LIGHT GUIDE HOLLINGER.....	37
BULLDOG clamp atrauma.....	100	chalazio curette HEBRA.....	377	COLD LIGHT GUIDE JACKSON.....	37
BULLDOG clamp DEBAKEY.....	100, 103	chalazio curette MEYHOEFER.....	377	COLD LIGHTclamp for Amnioskope.....	601
bulldog clamp DIETRICH.....	101	chalazio tissue forceps AYER.....	393	COLLER-CRILE hemostatic clamp.....	106
bulldog clamp GLOVER.....	103	chalazio tissue forceps DESMARRES.....	393	COLLIER needle holder.....	208
bulldog clamp JOHNS-HOPKINS.....	104	chalazio tissue forceps LAMBERT.....	393	COLLIER pelvimeter.....	605
BÜLOW-GUNAR-HEY tubing clamp.....	130	CHAPUT tissue grasping forceps.....	110	COLLIN abdominal retractor.....	190
BUMM uterine curette.....	597	CHARNLEY abdominal retractor.....	289	COLLIN clip forceps.....	224
BUNELL bone hand drills.....	299	CHARRIERE amputation saw.....	296	COLLIN dressing forceps.....	137
BUNELL tendon guide.....	294	CHEATLE sterilization forceps.....	227	COLLIN DYNAMOMETER.....	25
BUNELL tendon passing instr.....	292	cheek retractorSTERNBERG.....	453	COLLIN intestinal grasping forceps.....	539
BUNGE scoop.....	378	cheekSTEIN needle holder.....	210	COLLIN LOKTITE abdominalDE.....	191
BUNT sterilization clamp.....	227	CHELSEA-EATON proctoscope.....	563	COLLIN mallet.....	270
BURCH fixation forceps.....	373	CHERON dressing forceps.....	137	COLLIN navelstringclamp.....	605
BURKE biopsy forceps.....	590	CHEERY laminectomy retractor.....	488	COLLIN pelvimeter.....	605
BUSCH episiotomy scissors.....	64	CHEST SUPPORT KLEINSASSER.....	36	COLLIN retractor.....	139
BUSHE bone curette.....	256	CHEVALIER-JACKSON.....	473	COLLIN scalpel-handle.....	40
		CHEVALIER-JACKSON trachea cannula.....	479	COLLIN tissue grasping forceps.....	110
C		CHILDE clip forceps.....	224	COLLIN tongue forceps.....	453
cable bipolar.....	633	children atrauma vascular clamp.....	526	COLLIN uterine-grasping forceps.....	585
caliper TOWNLEY.....	26	chisel NEIVERT-ANDERSON.....	442	COLLIN uterine-probes.....	586
CANFIELD tonsil knives.....	466	chisels.....	259, 264	COLLIN vaginal specula.....	570
CAPLAN nose forceps.....	428	chisels ALEXANDER.....	259	COLLIN-DUVAL grasping PINZE.....	85
capsula scissors RESANO.....	53/2	chisels blade.....	266	COLLIN-HARTMANN retractor.....	141
capsular forceps ARRUGA.....	391	chisels BRUNETTI.....	268	Columella tissue forceps COTTLE.....	448

COLVER tonsil forceps.....	467	cup medicine.....	621	DEBAKEY vascular scissors.....	61
comedone extractor SAALFELD.....	608	cup sputum.....	621/1	DEBAKEY vascular scissors TC.....	60
comedone extractor SCHAMBERG.....	608	curette Antrum.....	435	DEBAKEY-BAHNSON aneurysm clamp.....	506
comedone extractor UNNA.....	608	curette Cobb.....	252	DEBAKEY-DIETRICH MINI BULLDOG clamp.....	101
comedone extractor WALTON.....	608	curette FAULKNER.....	449	DEBAKEY-MIXTER vascular clamp.....	499/2
compression bandage.....	296	curette forceps.....	416	DEBAKEY-MOSQUITO hemostatic clamp.....	509
CONE curette.....	280	curette HOUSE.....	420	DEBAKEY-PEAN atrauma clamp.....	513
CONE head punch.....	331	CUSCO vaginal specula.....	570	DEBAKEY-RANKIN atrauma clamp.....	512
CONE raspatories.....	280	Cushing (Taylor) tissue forceps TC.....	87	DEBAKEY-RUMEL vascular clamp.....	499
CONNIN-AMSLER marker.....	380	CUSHING anatomic tissue forceps.....	83	Decapitating hook BRAUN.....	607
CONVERSE nose hook.....	448	CUSHING brain spatula.....	336, 369	DECKER rongeur.....	341
CONVERSE septum knives.....	435	CUSHING drill.....	299	DEJERINE percussion mallet.....	24
COOLEY anastomosis clamp.....	519, 520 - 520/4	CUSHING laminectomy retractor forceps.....	340	Delee retractor.....	574
COOLEY atraumatic tissue forceps.....	99	CUSHING nerve ENhook.....	328	DEMEL wire guide needle.....	315
COOLEY catheter forceps.....	510	CUSHING retractor.....	152	DEMEL wire instrument.....	315
COOLEY retractor.....	148	CUSHING retractor.....	153	DENHART mouth gags.....	454
COOLEY rib spreader.....	487	CUSHING retractor.....	151, 152, 153	DENIS-BROWNE abdominal retractors.....	185
COOLEY vascular clamp.....	518, 522	CUSHING surgical tissue forceps.....	83	depth ruler.....	594
COOLEY-DERRA anastomosis clamp.....	519	CUSHING tissue forceps.....	87	DERF needle holder.....	208
COOLEY-NEONATAL rib spreader.....	485	CUSHING-TAYLOR anatomic tissue forceps.....	87	Dermatom HUMBY.....	50
COOLY suction tube.....	28	CUZZI ovum curette.....	606	Dermatom SILVER.....	50
COOPER ligaturee needle.....	219	cyclodialysis spatula BANGERTER.....	379	Dermatome SCHINK.....	49
CORDES interchangeable tips.....	472	cyclodialysis spatula CASTROVIEJO.....	379	dermatome blade.....	49
corneal dissector GREEN.....	374	cyclodialysis spatula ELSCHNIG.....	379	DESCHAMPS ligaturee needle.....	218
corneal dissector PATON.....	373	cyclodialysis spatula WHEELER.....	379	DESJARDINS gall stone curette.....	534
corneal scarifier ELSCHNIG.....	373	Cystotom BECKER.....	375	DESJARDINS gall stone forceps.....	530/2
corneal scarifier GILL.....	373	Cystotom GRAEFE.....	375	DESJARDINS gall stone probe.....	531
corneal scarifier TOOK.....	373	CZERNY hook forceps.....	584	DESJARDINS hemostatic clamp.....	121
CORONAL BROW retractor.....	198	CZERNY rectal-specula.....	559	DESMARRES chalazio tissue forceps.....	393
CORWIN-HEGAR wire forceps.....	319	CZERNY retractor.....	141	DESMARRES retractor.....	151
CORYLLOS retractor.....	166			DEUTSCHMANN cataract knives.....	371
CORYLLOS rib scissors.....	480	D		DEVILBISS head forceps.....	332
COS micro ear forceps.....	414	DALE vascular clamp.....	494, 495	Diagnostic set ECO "C".....	16
COTTLE columella tissue forceps.....	448	DANDY hemostatic clamp.....	109	Diagnostic set ECO "T".....	16
COTTLE fixation forceps.....	410	DANDY nerve hook.....	328	Diagnostic set RI-MINI.....	17
COTTLE mallet.....	273	DARDIK multi purpose clamp.....	509/1	Diagnostic set UNI III.....	15
COTTLE nose hook.....	447, 447/1	DARLING retractors.....	178	DIFFENBACH vascular clamp.....	104
COTTLE nose scissors.....	59	DARTIGUES uterine grasping forceps.....	585	DIETER micro ear forceps.....	414
COTTLE nose specula.....	423	DASTOOR strabismus forceps.....	386	DIETRICH blood vessel clamp.....	510
COTTLE scissors.....	56	DASTOOR suction tube.....	380	DIETRICH MINI-bulldog clamp.....	101
COTTLE septum chisels.....	440	DAUBENSPECK bone currettes.....	255	DIETRICH vascular scissors.....	60
COTTLE septum elevator.....	439	DAVIDSON(SCAPULA) retractor.....	166	dilation bougie DITTEL.....	554
COTTLE septum knives.....	435	DAVIEL cataract curette.....	377	dilation bougie GUYON.....	554
COTTLE skin hook.....	447, 448	DAVIS brain spatula.....	337	dilation bougie VAN BUREN.....	554
COTTLE-JOSEPH septum.....	439	DAVIS dura dissector.....	379	DINGMANN bone holding forceps.....	246
COTTLE-KAZANJIAN bone cutting forceps.....	241	DAVIS foreign body needle.....	374	DINGMANN mouth gag.....	456
COTTLE-NEIVERT.....	448	DAVIS sterilization tissue forceps.....	227	DINGMANN raspatories.....	463
cotton-applicator.....	203	DAVIS-BOYLE.....	455	DINGMANN retractor.....	463
cotton-applicator FARRELL.....	203	DAVIS-BOYLE SPERRE.....	455	DINGMANN spreader.....	456
cotton-applicator JOBSON-HORNE.....	203	DAVIS-MEYER mouth gag.....	457	DIPLOMAT Sphygmomanometer.....	5
cotton-applicator REDA.....	203	DAY hook.....	409	discision knives BERENS.....	372
cotton-applicator TOBOLD.....	203	DE BAKEY needle holder.....	210	discision knives CASTROVIEJO.....	372
cotton-applicator UCKERMANN.....	203	DE BAKEY vascular clamp.....		discision knives JAEGER.....	372
COXETER METAL catheter.....	555	.....	493-500, 502, 505-508, 512-517	discision knives WHEELER.....	373
CRAFOOD-SELLORS hemostatic clamp.....	118	DE BAKEY vascular scissors.....	60, 61	discision knives ZIEGLER.....	373
CRAFOORD hemostatic clamp.....	118	DE BAKEY vascular-dilator.....	529	discision needle.....	374
CRAFOORD lung scissors.....	65/2	DE BOER rib spreader.....	486	discision needle BOWMAN.....	374
cranplast BRAUN.....	607	DE LEE obstetrical forceps.....	602	disimpaction forceps ROWE.....	459
cranplast TARNIER.....	607	DE MARTEL guide sleeve.....	330	dissecting scissors.....	52, 52/1, 53
CREGO elevator.....	282	DE MARTEL-WOLFSON.....	546	dissecting scissors.....	53/2
CRILE hemostatic clamp.....	107	DEAN iris knives.....	372	dissecting scissors DEAVER.....	52
CRILE needle holder.....	213	DEAN tonsil scissors.....	59	dissecting scissors JORGENSEN.....	53
CRILE nerve hook.....	328	DEAVER dissecting scissors.....	52	dissecting scissors LEXER.....	53
CRILE retractor.....	140	DEAVER retractor.....	145	dissecting scissors LEXER-BABY.....	53
CRILE-MURRAY needle holder.....	209	DEAVER-GRIP retractor.....	146	dissecting scissors LEXER-BABY TC.....	53
CRILE-RANKIN hemostatic clamp.....	107	DEBAKEY aortic clamp.....	505	dissecting scissors MAYO.....	52/1
CRILE-WOOD needle holder.....	209	DeBaKey atrauma bulldog clamp.....	100, 103	dissecting scissors MAYO TC.....	52/1
CRITCHETT eye specula.....	370	DEBAKEY atrauma clamp.....	100	dissecting scissors MAYO-NOBLE.....	52/1
crown scissors BEEBEE.....	68	DEBAKEY atrauma clamp.....	103	dissecting scissors MAYO-STILLE.....	52/1
CRUTCHFIELD head holder.....	327	DEBAKEY atraumatic tissue forceps.....	99	dissecting scissors METZENBAUM.....	53/1
CRUTCHFIELD cervical traction tong.....	327	DEBAKEY retractor.....	189/1	dissecting scissors METZENBAUM.....	53/1
cuff for leg.....	295	DEBAKEY suction tube.....	28	dissecting scissors METZENBAUM FINO.....	53/1
cuff for upper arm.....	295	DEBAKEY vascular clamp.....	493-500, 502, 505-508, 512-517	dissecting scissors METZENBAUM FINO TC.....	53/1

dissecting scissors METZENBAUM TC .....	53/1	dura scissors SCHMIEDEN-TAYLOR .....	65/1	ESMARCH bandage scissors .....	69/2
dissecting scissors PECK-JOSEPH .....	74	duraNTE grasping tissue forceps .....	88	ESMARCH plaster knives .....	233
dissecting scissors TOENNIS-ADSON .....	65	DUVAL grasping tissue forceps .....	85	ETHICON clip forceps .....	524
dissector FISCH .....	420	DUVAL intestinal grasping forceps .....	539	EVES tonsil snare .....	468
dissector GORNEY .....	277	Dynamometer COLLIN .....	25	EXACTA Sphygmomanometer .....	8
dissector PENFIELD .....	333			Exenteration curette BUNGE .....	378
DITTEL dilation bougie .....	554	<b>E</b>		extensions bows BOEHLER .....	312
DIX foreign body chisels .....	374	ear catheter HARTMANN .....	408	extensions bows KIRSCHNER .....	312
DIX foreign body instrument .....	380	ear curette BUCK .....	407	extensions bows KIRSCHNER US .....	312
double curette VOLKMANN .....	257	ear curette GROSS .....	409	extirpation chisels ROLLET .....	374
DOUGHTY tongue blade .....	458	ear forceps HARTMANN .....	411	extraction dissector LANG .....	378
DOUGLAS cilia forceps .....	395	ear forceps HEYMANN-KNIGHT .....	425	extraction hook ARRUGA .....	375
DOUGLAS tonsil knives .....	466	ear forceps JANSEN .....	424	extraction hook KNAPP .....	375
DOUGLAS trocar .....	204	ear forceps LITTAUER .....	411	extraction hook ROLLET .....	375
DOYEN abdominal retractor .....	189/1	ear forceps LUCAE .....	410	extractor KUENTSCHER .....	322
DOYEN gynecological scissors .....	63	ear forceps TILLEY .....	411	eye cannula MCINTYRE .....	394
DOYEN intestinal clamp .....	540	ear forceps TROELTSCH .....	424	eye cannula type AIR INJECTION .....	394
DOYEN myoma a screw .....	594	ear forceps WILDE (TROELTSCH) .....	410	eye cannula type SHEETS .....	394/2
DOYEN probes .....	199	ear knives POLITZER .....	408	eye magnet REDA .....	395
DOYEN raspatories .....	278	ear knives SEXTON .....	408	eye scissors BARRAQUER .....	75
DOYEN retractor .....	163	ear lever ZAUFAL .....	409	eye scissors NOYES .....	75
DOYEN scissors .....	63	ear lever ZAUFAL-JANSEN .....	409	eye scissors VANNAS .....	79
DOYEN towel clamp .....	133	ear loop BILLEAU .....	409	eye scissors WECKER .....	75
DOYEN uterine polyp forceps .....	585	ear loop SHAPLEIGH .....	410	eye scissors WESTCOTT .....	75
DOYEN vaginal specula .....	574	ear probes STACHE .....	199	eye specula ARRUGA .....	370
DOYEN-BABY intestinal clamp .....	540	ear specula BOUCHERON .....	399	eye specula BARRAQUER .....	370
DOYEN-JANSEN(MOLT) .....	454	ear specula BRUENINGS .....	401	eye specula BOWMAN .....	370
DOYEN-JANSEN(MOLT) mouth gags .....	454	ear specula GRUBER .....	399	eye specula CASTROVIEJO .....	371
DOYEN-STILLE .....	167	ear specula HARTMANN .....	399	eye specula CLARK .....	370
dressing forceps BOZEMANN .....	138	ear specula POLITZER .....	399	eye specula CRITCHETT .....	370
dressing forceps BOZEMANN-DOUGLAS .....	138	ear specula RICHNAU-HOLMGREN .....	400	eye specula GRAEFE .....	370
dressing forceps BRYANT .....	137	ear specula SIEGLE .....	402	eye specula LANCASTER .....	371
dressing forceps CHERON .....	137	ear specula TOYNBEE .....	399	eye specula LISTER-BURCH .....	370
dressing forceps COLLIN .....	137	ear syringe REINER .....	406	eye specula MELLINGER .....	370
dressing forceps FOERSTER .....	136	ECHLIN bone rongeur .....	240	eye specula MELLINGER-AXENFELD .....	370
dressing forceps GROSS-MAIER .....	134	ECO "C" Diagnostic set .....	16	eye specula MUELLER .....	371
dressing forceps BOZEMANN-DOUGLAS .....	138	ECO "T" Diagnostic set .....	16	eye specula MURDOCK .....	370
dressing forceps MAIER .....	134	EICKEN (KILLIAN) irrigation cannula .....	433	eye specula PARK .....	371
dressing forceps PELKMANN .....	137	elevator ALDERDYCE .....	282	eye specula SMITH .....	370
dressing forceps RAMPLEY .....	136	elevator BOIES .....	277	eye specula WEEK .....	370
dressing forceps SIMS-MAIER .....	134	elevator CREGO .....	282	eye specula WILLIAMS .....	370
dressing forceps ULRICH .....	135	elevator DINGMANN .....	463, 463/3	eye specula ZIEGLER .....	371
dressing tissue forceps JACKSON .....	471	elevator FREER .....	434	eye specula STEVENSON .....	371
drill bits .....	302	elevator KEY .....	282	eye suction -irrigation cannula .....	394
drill CUSHING .....	299	elevator LEMPERT .....	420		
drill ERRICO .....	299	elevator LUNIATSCHEK .....	465	<b>F</b>	
drill MC KENZIE .....	299	elevator McDONALD .....	283	Face Lift scissors FREEMAN .....	74
drill wire .....	299	elevator MURPHY-LANE .....	283	Face Lift scissors GORNEY .....	73
drills .....	299	elevator SAYRE .....	281	Face Lift scissors KAYE .....	73
drillwire KIRSCHNER .....	306, 307	elevator WATSON-CHEYNE .....	283	Face Lift scissors REES .....	73
driver KUENTSCHER .....	321	ELLIOT obstetrical forceps .....	603	FANSLER proctoscope .....	564
drivers .....	321	ELLIS foreign body gouges .....	374	FARABEUF bone holding forceps .....	243
drums SCHIMMELBUSCH .....	622	ELSCHING capsular forceps .....	391	FARABEUF raspatories .....	274
DUBOIS gynecological scissors .....	63	ELSCHING corneal scarifier .....	373	FARABEUF retractor .....	139
DUEHRSEN anatomic tissue forceps .....	84	ELSCHING cycloclialysis spatula .....	379	FARABEUF-COLLIN raspatories .....	274
DUPLAY dressing forceps .....	134	ELSCHING fixation forceps .....	389	FARABEUF-LAMBOTTE bone holding forceps .....	243
DUPLAY hook forceps .....	582	EMMETT fistula hook .....	594	FARRELL cotton-applicator .....	203
DUPLEX stethoscope .....	23	ENDERmail STEINMANN .....	307	FARRIOR ear specula .....	400
DUPUY-WEISS tonsil knives .....	466	endoscop eassembly .....	188	FARRIOR ear specula .....	400
dura dissector .....	332	endoscope wire basket .....	623	FAULKNER curette .....	449
dura dissector DAVIS .....	332	Endospecula KOGAN .....	577	FAURE biopsy forceps .....	588
dura dissector FRAZIER .....	333	ENGEL plaster cast saw .....	229	FAURE peritoneum clamp .....	123
dura dissector HOEN .....	333	enterotomy scissors .....	66	FAVALORO vascular scissors .....	61
dura dissector HORSLEY .....	333	Entropium forceps SNELLEN .....	393	FEHLAND intestinal clamp .....	542
dura dissector MILLIGAN .....	332	enucleation curette WELLS .....	378	FEILCHENFELD tissue forceps .....	91
dura dissector OLIVECRONA .....	332	ENUCLEATION scissors .....	58	FELDHEIM bone holding clamp .....	249
dura dissector SACHS .....	332	epiglottis retractor FRAENKEL .....	471	FERGUSSON bone holding forceps .....	243
dura dissector TOENNIS .....	332	epiglottis retractor JACKSON .....	471	FERGUSSON clamp .....	109
dura dissector WOODSON .....	333	epiglottis retractor REICHERT .....	471	FERGUSSON FRAZIER suction tube .....	337
dura hook .....	335	episotomy scissors WALDMANN .....	64	FERGUSSON gall stone curette .....	533
dura hook ADSON .....	328	EPKER osteotome .....	464/2	FERGUSSON surgical scissors .....	66
dura hook JACOBSON .....	335	EPPENDORFER biopsy forceps .....	590	FERRIERA retractor .....	197
dura knives KOOS .....	335	ERICH wire pusher .....	461/2	FERRIS-SMITH laminectomy retractor forceps .....	343



FERRIS-SMITH surgical tissue forceps .....	85	FREER skin hook.....	448	graduated measure .....	620
FERRIS-SMITH-KERRISON rongeur .....	344, 344/2	FRENZEL nystagmus spectacles.....	20	GRAEFFE cataract curette .....	377
FICHOCHIETTO-BABY rib spreader .....	482	FRENZEL tongue depressors.....	451	GRAEFFE cataract knives .....	371
files nail .....	612/1	FRIEDMANN MINI bone rongeur .....	234	GRAEFFE cystotome .....	375
FINGER nail drill .....	297	FRIEDMANN specula .....	577	GRAEFFE discision knives .....	372
finger protector LANGENBECK .....	311	FRITSCH retractor.....	163	GRAEFFE discision knives .....	372
Finger ring saw REDA .....	297	FRYKHOLM bone rongeur .....	240	GRAEFFE fixation forceps .....	389
Finger ring saw WALTON .....	297	FUCHS capsular forceps .....	391	GRAEFFE hook .....	148/2
Finger-Goniometer .....	25	FUCHSIG hemostatic clamp .....	113	GRAEFFE IRIS tissue forceps .....	382
Fingersaw LANGENBECK.....	296			Graefe scissors.....	56
FINOCCHIETTO bronchusclamp.....	490	G		GRAEFFE strabismus hook.....	375
FINOCCHIETTO rib spreader.....	482	Galeahook YASARGIL.....	330	GRAEFFE tissue forceps .....	83
FINOCCHIETTO Baby rib spreader .....	482	gall duct dilator BAKES.....	532	GRAFFFE eye specula .....	370
FINOCCHIETTO needle holder .....	211	gall stone curette DESJARDINS.....	534	GRAHAM nerve hook .....	328
FINOCCHIETTO rib spreader .....	484	gall stone curette FERGUSSON.....	533	grasping forceps.....	316
FINOCCHIETTO-BURFORD rib spreader .....	483	gall stone curette LUER-KOERTE .....	533	grasping forceps.....	415
FINSEN retractor .....	168	gall stone curette MAYO .....	534	grasping forceps LAHEY .....	479
FISCH dissector .....	420	gall stone curette MOOR .....	531	grasping forceps MARTEL .....	110
FISCH fine hook .....	335	gall stone forceps BLAKE .....	530/2	grasping forceps PRATT .....	110
FISCHER iris tissue forceps .....	384	gall stone forceps DESJARDINS .....	530/2	grasping forceps WILLET MARTEL.....	110
FISH probes .....	199	gall stone forceps MAYO-BLAKE .....	530/2	grasping tissue forceps COLLIN-DUVAL .....	85
FISHER tonsil knives.....	466	gall stone forceps MIXTER .....	530/2	grasping tissue forceps duraNTE .....	88
fistula hook EMMETT .....	594	gall stone probes DESJARDINS .....	531	grasping tissue forceps DUVAL .....	85
fistula probes PRATT.....	563	gall stone probes MAYO .....	534	grasping tissue forceps LERCHE .....	83
fistulapropes LOCKHART-MUMMERY.....	200	gall stone probes MOYNIHAN .....	531	grasping tissue forceps RUSS MODELL .....	85
fixation forceps BARRAQUER.....	390	GALLAHER ANTRUM rasp.....	446	GRAVE vaginal specula.....	570
fixation forceps CASTROVIEJO .....	390	GASS hook.....	376	GRAY hemostatic clamp .....	121
fixation forceps Cottle .....	410	GAUSS scalp forceps .....	605	GREEN corneal dissector.....	374
fixation forceps ELSCHNIG .....	389	GELPI abdominal retractor .....	189/1, 189/2	GREEN fixation forceps.....	390
fixation forceps GRAEFE .....	389	GELPI hook .....	193	GREEN muscle hook .....	375
fixation forceps GREEN.....	390	GEMINI hemostatic clamp .....	115	GREEN retractor.....	160
fixation forceps LESTER .....	389	GERALD anatomic tissue forceps.....	86	GREEN-armYTAGE .....	605
Fixierforc BURCH.....	373	GERALD surgical tissue forceps .....	87	GREGOIRE intestinal forceps.....	538
Flat forceps .....	316, 317	GERSTER bone holding clamp .....	250	GREVIN micro ear forceps .....	414
FOERSTER dressing forceps .....	136	GERZOG mallet.....	270	GROSS ear curette.....	409
FOERSTER IRIS tissue forceps .....	383	GIERTZ-STILLE rib scissors.....	481	GROSS-MAIER dressing forceps .....	134
FOMON nose rasp .....	444	GIGLI saw .....	332	GRUBER ear specula .....	399
FOMON nose scissors .....	58	GILL corneal scarifier .....	373	guide driver.....	321
FOMON raspatories .....	277	GILL iris tissue forceps.....	384	guide needle REDON .....	207
FOMON Rhinoplastscissors .....	65/1	GILL-ARRUGA capsular forceps.....	390	GUILLEN suction raspatories.....	433/1
FOMON septum chisels .....	441	GILL-HESS iris tissue forceps.....	384	gum scissors LA GRANGE.....	69
FOMON skin hook .....	447/1	GILLIES needle holder .....	212	gumscissors GOLDMAN-FOX.....	67
FOMON TC nose rasp.....	445	GILLIES skin hook .....	448	gumscissors LOCKLIN .....	69
FOREGGER laryngoscope .....	29, 31	GILLIES surgical tissue forceps .....	86	gumscissors QUINBY .....	67
foreign body chisels DIX .....	374	GIL-VERNET retractor .....	152	GUTHRIE skin hook .....	148/2
foreign body curette ALVIS .....	374	GLOVER atrauma clamp .....	100	GUYON catheter eingleide.....	554
foreign body forceps HARTMANN.....	412	GLOVER bulldog clamp .....	103	GUYON dilation bougie.....	554
foreign body forceps HARTMANN-HOFFMANN .....	412	GLOVER vascular clamp .....	515	GUYON hemostatic clamp .....	122
foreign body forceps HARTMANN-WULLSTEIN.....	412	GLUCK rib scissors .....	480	GUYON kidney clamp .....	122
foreign body forceps MATHIEU .....	553/1	GOELET retractor.....	141	GUYTON-LUNDSGAARD sclerotome .....	373
foreign body gouges ELLIS .....	374	GOLDMANN-FOX gum scissors .....	67	gynecological scissors DOYEN .....	63
foreign body gouges WALTON.....	374	GOMEL microsurgical tissue forceps.....	96	gynecological scissors DUBOIS .....	63
foreign body instr. DIX .....	380	GOMMEL micro scissors .....	80	gynecological scissors SIEBOLD .....	62
foreign body lever BUCK .....	412	goniometer for finger .....	25	gynecological scissors SIMS .....	62
foreign body lever QUIRE.....	412	goniometer MOELTGEN.....	25	gynecological scissors WERTHEIM .....	63
foreign body needle.....	374	goniotomy knives BARKAN .....	373		
foreign body needle DAVIS .....	374	goniotomy knives SCHEIE .....	373	H	
foreign body needle FRANCIS .....	374	GOOD tonsil scissors .....	59	HABERER intestinal spatula .....	143/3
foreign body needle LA FORCE .....	374	GOODELL uterine Dilatator .....	581	haemorrhoid forceps McGIVNEY .....	568
foreign body needle LEVINSON.....	374	GORNEY dissector.....	277	haemorrhoid LigatorRUDD .....	568
FOX LUPUS curette .....	608	GORNEY FACE LIFT scissors .....	73	haemorrhoidal clamp FERGUSSON .....	109
FRAENKEL interchangeable tips.....	472	GOSSET abdominal retractor .....	181	haemorrhoidal forceps HEYWOOD-SMITH .....	567
FRANCIS foreign body needle .....	374	gouges .....	264	Haemorrhoidal Ligator MC GIVNEY.....	568
FRAZIER abdominal retractor .....	181	gouges PARTSCH .....	259	HAGLUND-STILLE plaster retractor .....	232
FRAZIER dura dissector.....	333	gouges COBB .....	262	HAIGHT rib spreader .....	487
FRAZIER punctum cannula .....	337	gouges HIBBS .....	265	HAJEK mallet .....	273
FRAZIER skin hook .....	148/2	gouges LEXER MINI.....	263	HAJEK septum chisels.....	442/1
FREEMAN face lift scissors.....	74	gouges WEST.....	442/1	HAJEK-BALLENGER elevator .....	439
FREEMAN retractor .....	198	gouges ZIELKE.....	264	HAJEK-KOFLER rongeur .....	429, 431
FREER elevatorIUM .....	434	gougesSTILLE .....	260	HALLE bone currettes .....	253
FREER septum chisels.....	439, 442	GOURDET uterine curette .....	599	HALLE septum elevator .....	437
FREER septum elevator .....	437	GRADLE cilia forceps .....	395	halogen lamp for laryngoscope .....	29
FREER septum knives .....	434	GRADLE ophthalmologic scissors .....	57	HALSEY needle holder.....	208

HALSTED-MOSQUITO hemostatic clamp .....	105	hemostatic clamp JACOBSON .....	105	hook BARBARA .....	419
handle for chisels/chisels .....	266	hemostatic clamp JOHNS-HOPKINS .....	120	hook DAY .....	409
handle For chisels/OSTEO .....	266	hemostatic clamp KANTROWITZ .....	119	hook FISCH .....	335
handle scalpel .....	38, 39, 39/1, 39/2, 40, 41	hemostatic clamp KELLY .....	106	hook forceps BARRET .....	582
handle scalpel MINI .....	41	hemostatic clamp KELLY-RANKIN .....	106	hook forceps BRAUN .....	582
HANK uterine dilator .....	580	hemostatic clamp KOCHER .....	108	hook forceps CZERNY .....	584
HARGIS awl .....	463	hemostatic clamp LAHEY .....	120	hook forceps DUPLAY .....	582
HARGIS mandibular body retractor .....	463/6	hemostatic clamp LAWRENCE .....	119	hook forceps HULKA .....	583
HARGIS raspatory .....	463/2	hemostatic clamp LERICHE .....	111	hook forceps IOWA .....	584
HARKEN auricle clamp .....	503	hemostatic clamp LOVELACE .....	109	hook forceps JACOBS .....	583
HarmS lachrymal probes .....	381	hemostatic clamp LOWER .....	120	hook forceps JARCHO .....	583
HarmS probes .....	333	hemostatic clamp MAYO-GUYON .....	122	hook forceps MUSEUX .....	583
HARRINGTON bronchusclamp .....	490	hemostatic clamp MEEKER .....	119	hook forceps PRATT .....	584
HARRINGTON hook .....	193	hemostatic clamp Micro-HARTMANN .....	104	hook forceps Schröder .....	584
HARRINGTON -PEMBERTON retractor .....	147	hemostatic clamp MIXTER .....	119, 121	hook forceps SCHROEDER .....	583
HARRINGTON retractor .....	147	hemostatic clamp MIXTER-BABY .....	119	hook forceps SCHROEDER (POZZI) .....	582
HARTMANN ear catheter .....	408	hemostatic clamp MOYNIHAN .....	121	hook forceps SKENE .....	582
HARTMANN ear specula .....	399	hemostatic clamp O'SHAUGNESSY .....	120	hook forceps TEALE .....	583
HARTMANN foreign body forceps .....	412	hemostatic clamp OVERHOLT .....	114	hook forcepsSTAUDE-MOORE .....	582
HARTMANN foreign body lever .....	411	hemostatic clamp PEAN .....	108	hook GASS .....	376
HARTMANN hemostatic clamp .....	104	hemostatic clamp PEAN .....	110	hook GELPI .....	193
HARTMANN nose specula .....	422, 427	hemostatic clamp PENNINGTON .....	109	hook HARRINGTON .....	193
HARTMANN polyp forceps .....	424	hemostatic clamp PROVIDENCE-HOSPITAL .....	106	hook KELLY .....	193
HARTMANN tongue depressors .....	452	hemostatic clamp ROBERTS .....	117	hook KUGLEN .....	376
HARTMANN tuning forc. .....	403	hemostatic clamp ROCHESTER-CarmALT .....	109	hook LUCAE .....	409
HARTMANN-HALLE nose specula .....	421	hemostatic clamp ROCHESTER-OCHSNER .....	108	hook McGEE .....	419
HARTMANN-HOFFMANN foreign body forceps .....	412	hemostatic clamp ROCHESTER-PEAN .....	108	hook SCOVILLE .....	196
HARTMANN-WULLSTEIN foreign body forceps .....	412	hemostatic clamp RUMEL .....	117	hook SINSKEY .....	376
HASSON retractor .....	143	hemostatic clamp SAROT .....	118	hook SMELLIE .....	605
HAUGH micro ear forceps .....	414	hemostatic clamp S-cvd MIXTER .....	116	hook WAGENER .....	409
HAYES rectum clamp .....	545	hemostatic clamp SPENCER-WELLS .....	109	hookSt.EVENS .....	375
head holder CRUTCHFIELD .....	327	hemostatic clamp STILLE .....	122	HOPKINS plaster knives .....	233
head mirror ZIEGLER .....	21	hemostatic clamp TOENNIS .....	117	HORIZON clip forceps .....	524
head punch CONE .....	331	hemostatic clamp WIKSTROEM .....	117	HORSLEY dura dissector .....	333
HEANEY hysterectomy clamp .....	126	hemostatic clamp ZENKER .....	118	HÖSEL retractor .....	167
HEANEY needle holder .....	210	hemostatic clampOVERHOLT-BABY .....	114	HOUSE curette .....	420
HEANY biopsy curette .....	587	hemostatic clampOVERHOLT-GEISSENDÖRFER .....	114	HOUSE suction tubeE .....	337/2
HEANY retractor .....	164	hemostatic clampOVERHOLT-MIXTER .....	115	HOWARTH septum elevator .....	438
HEANY-BALLENTINE hysterectomy clamp .....	127	hemostats .....	259	HUBER UNIVERSALhandle .....	472
hear light CLAR .....	22	HENKE tonsil-elevator .....	465	HUDSON bone hand drills .....	299
HEATH mallet .....	273	HENLEY retractors .....	170	HUDSON T-handle .....	300
HEATH suture scissors .....	66	HENNIG plaster retractor .....	232	HULKA hook forceps .....	583
HEBRA chalazial curette .....	377	HEPP-SCHIEDL micro scissors .....	78	HUMBY DERMATOM .....	50
HEGAR uterine dilator .....	578, 579	HERCULES wire cutter .....	320/1 - 320/3	HUNTER splinter forceps .....	91
HEGENBARTH clip tissue forceps .....	224	HERRICK NIERENSTIEL clamp .....	123	HURD tonsil elevator .....	465
HEIFETZ brain spatula .....	369	HESS capsular forceps .....	391	hypophyse curette .....	334
HEIMING kidney stone forceps .....	536	HESS iris tissue forceps .....	384	hypophyse tissue forceps ADSON .....	334
HEISS hemostatic clamp .....	112	HEYMANN septum forceps .....	425	hysterectomy clamp HEANEY .....	126
HEISTER mouth gags .....	454	HEYMANN nose scissors .....	58	hysterectomy clamp HEANY-BALLENTINE .....	127
hemostatic clamp ADSON .....	112	HEYMANN-KNIGHT ear forceps .....	425	hysterectomy clamp MAINGOT .....	123/1, 123/2
hemostatic clamp ADSON-BABY .....	113	HEYWOOD-SMITH haemorrhoidal forceps .....	567	hysterectomy clamp ROGERS .....	127
hemostatic clamp BAINBRIDGE .....	120	HIBBS chisels .....	265	hysterectomy clamp SEGOND .....	125
hemostatic clamp BENGOLEA .....	112	HIBBS gouges .....	265	hysterectomy clamp SEGON-LANDAU .....	125
hemostatic clamp BIRKETT .....	116	HIBBS retractor .....	164	hysterectomy clamp WERTHEIM .....	124
hemostatic clamp BRIDGE .....	116	HILL-FERGUSON rectal-specula .....	560	hysterectomy clamp WERTHEIM .....	128
hemostatic clamp COLLIER-CRILE .....	106	HIRSCHMAN spatula .....	331	hysterectomy forceps WERTHEIM-CULLEN .....	125
hemostatic clamp CRAFOORD .....	118	HIRSCHMANN anoscope .....	562	hysterectomy scissors WERTHEIM .....	63
hemostatic clamp CRAFOORD-SELLORS .....	118	HOEN dura dissector .....	333		
hemostatic clamp CRILE .....	107	HOESEL needle holder .....	213		
hemostatic clamp CRILE-RANKIN .....	107	HOFER retractor .....	465		
hemostatic clamp DANDY .....	109	HOFFMANN tubing clamp .....	624		
hemostatic clamp DEBAKEY-MOSQUITO .....	509	HOHMANN bone levers .....	284, 285		
hemostatic clamp DEBAKEY-PEAN .....	513	HOHMANN MINI .....	286		
hemostatic clamp DEBAKEY-RANKIN .....	512	HOKÉ chisels .....	265		
hemostatic clamp DESJARDINS .....	121	holding arm system LEYLA .....	368 - 368/4		
hemostatic clamp FUCHSIG .....	113	holding clamp ADSON .....	298		
hemostatic clamp GEMINI .....	115	HOLLINGER laryngoscope .....	37		
hemostatic clamp GRAY .....	121	HOLLINGER LIGHT GUIDE .....	37		
hemostatic clamp GUYON .....	122	HOLSHER nerve hook .....	329		
hemostatic clamp HALSTED-MOSQUITO .....	105	HOLTH rongeur .....	380		
hemostatic clamp HALSTED-MOSQUITO titanium .....	105	HOLZBACH hysterectomy clamp .....	126		
hemostatic clamp HARTMANN .....	104	HOLZHEIMER retractor .....	168		
hemostatic clamp HEISS .....	112	hook BALFOUR .....	193		
				I	
				I.U.D. extractor hook .....	593
				I.U.D. SERPENTINE GRASPER .....	593
				impactor/extractor .....	322/1
				incision scissors .....	52
				INGE lamina spreader .....	339
				INGROWN nail instrument .....	612/1
				INSTRU-CARE instrument oil .....	635
				instrument BOX .....	617
				instrument oil INSTRU CARE .....	635
				Insufflationcannula VERESS .....	206
				interchangeable tips BARACANI .....	472
				interchangeable tips BRUENINGS .....	472
				interchangeable tips CORDES .....	472
				interchangeable tips FRAENKEL .....	472

interchangeable tips FRAENKEL.....	472	IWANSON Measuring instrument.....	624	KERRISON rongeur.....	428
interchangeable tips KRAUSE.....	472	J		KEVORKIAN biopsy curette.....	587
interchangeable tips LANGE.....	472	JACKSON laryngoscope.....	37	KEVORKIAN biopsy forceps.....	589, 591
interchangeable tips SCHEINMANN.....	472	JACKSON tendon grasping forceps.....	292	KEVORKIAN-PACIFIC biopsy forceps.....	592
interchangeable tips SCHUMACHER.....	472	JACKSON trachea hook.....	476	KEY elevator.....	282
interchangeable tips SEIFERT.....	472	JACKSON vaginal specula.....	573	KEYES punch.....	608
intervertebral disc rongeur COLCLOUGH.....	344/1	JACKSON-BURROWS retractor.....	189/2	kidney clamp GUYON.....	122
intestinal clamp BABY-KOCHER.....	540	JACOBS hook forceps.....	583	kidney forceps HERRICK.....	123
intestinal clamp Brunner.....	543	JACOBSON buttonprobes.....	335	kidney stone forceps HEIMING.....	536
intestinal clamp DOYEN.....	540	JACOBSON curette.....	257	kidney stoneforceps RANDALL.....	535
intestinal clamp FEHLAND.....	542	JACOBSON dura hook.....	335	kidney tray.....	619
intestinal clamp KOCHER.....	540	JACOBSON hemostatic clamp.....	105	KIELLAND obstetrical forceps.....	602
intestinal clamp MAYO-ROBSON.....	541	JACOBSON needle holder.....	215	KIELLAND-LUIKART obstetrical forceps.....	603
intestinal clamp PAYR.....	548	JAEGER discision knife.....	372	KILLIAN gouges.....	442/1
intestinal clamp RESANO.....	542	JAEGER lid plate.....	371	KILLIAN nose specula.....	423
intestinal clamp SCUDDER.....	541	JAMESON strabismus forceps.....	385	KILLIAN septum elevator.....	438, 439
intestinal clampSt.ONE-WATT.....	545	JAMESON strabismus hook.....	375	KILLIAN septum scissors.....	471
intestinal forceps GREGOIRE.....	538	JANSEN bone curettes.....	257	KILLIAN-CLAUS septum gouges.....	442/1
intestinal grasping forceps ALLIS.....	537	JANSEN bone rongeur.....	237	KILNER needle holder.....	212
intestinal grasping forceps ALLIS-ADAIR.....	537	JANSEN ear forceps.....	424	KILNER nose hook.....	447/1
intestinal grasping forceps ALLIS-BABY.....	537	JANSEN retractor.....	168	KILNER skin hook.....	608
intestinal grasping forceps ATRAUMA.....	111	Jar.....	620	KILNER surgical scissors.....	541/1
intestinal grasping forceps BABCOCK.....	539	JARCHO hook forceps.....	583	KILNER/RAGNELL supercut scissors.....	72
intestinal grasping forceps COLLIN.....	539	JAVID carotid shunt clamp.....	511	KILNER-DOUGHTY mouth gag.....	456
intestinal grasping forceps DOYEN-BABY.....	540	JENNINGS mouth gags.....	454	KIRBY-ARTHUR IRIS forceps.....	385
intestinal grasping forceps DUVAL.....	539	jewelry tissue forceps.....	90	KIRK mallet.....	270
intestinal grasping forceps JUDD-ALLIS.....	538	JOBSON-hornyE cotton-applicator.....	203	KIRSCHNER.....	312
intestinal grasping forceps LITTLEWOOD.....	538	JOHNS-HOPKINS applier forceps.....	104	KIRSCHNER abdominal retractor.....	187, 187/1
intestinal grasping forceps LOCKWOOD-ALLIS.....	538	JOHNS-HOPKINS bulldog clamp.....	104	KIRSCHNER abdominal retractor.....	185, 187
intestinal grasping forceps THOMS-ALLIS.....	538	JOHNS-HOPKINS bulldog clamp.....	104	KIRSCHNER bone hand drills.....	299
intestinal grasping forceps WILLIAMS.....	539	JOHNS-HOPKINS hemostatic.....	120	KIRSCHNER drill wire.....	306, 307
intestinal spatula HABERER.....	143/3	JOHNSON needle holder.....	211	KIRSCHNER guideprobes.....	221
intestinal spatula LERICHE.....	143/3	JONES towel clamp.....	132	KIRSCHNER nail.....	308, 309
intestinal spatula REVERDIN.....	143/3	JONES-clip towel clamp.....	132	KIRSCHNER US extension bow.....	312
intestinal spatula RIBBON.....	143/1	JORGENSEN dissecting scissors.....	53	KLAPP retractor.....	150
intima spatula.....	530/1	JOSEPH (LEWIS) nose rasp.....	443	KLEINERT-KUTZ rongeur.....	237
intra oral retractors.....	463/1, 463/4	JOSEPH nose rasp.....	443	KLEINERT-KUTZ skin hook.....	149
intramedullary drills.....	322	JOSEPH nose saw.....	446	KLEINERT-KUTZ tendon grasping instrument.....	294
IOWA hook forceps.....	584	JOSEPH raspatories.....	277	KLEINSASSER chest support.....	36
IOWA needle guide.....	206	JOSEPH septum.....	437	KLEINSASSER injection cannula.....	36
Iris hook O'CONNOR.....	375	JOSEPH septum knives.....	434	KLEINSASSER light guide.....	36
Iris hook WIENER.....	375	JOSEPH septum knives.....	434, 435	KLEINSASSER suction tube tube.....	36
Iris knives DEAN.....	372	JOSEPH skin hook.....	149	KLEINSCHMIDT appendix intestinal clamp.....	544
Iris knives KNAPP.....	372	JOSEPH surgical scissors.....	54/1	KLINKENBERGH-LOTH vascular scissors.....	65/1
Iris knives ZIEGLER.....	372	JUDD-ALLIS intestinal grasping forceps.....	538	KNAPP cataract curette.....	378
IRIS scissors.....	54/2	JUDD-MASSON bladder retractors.....	552	KNAPP extraction hook.....	375
Iris scissors KNAPP.....	55	JUERS micro ear forceps.....	414	KNAPP iris knives.....	372
Iris scissors LITTLER.....	55	JURASZ laryngeal polypus forceps.....	471	KNAPP IRIS scissors.....	55
Iris spatula WECKER.....	378	K		KNAPP-LUER forceps.....	393
IRIS supercut scissors.....	72	KABIERSKE powder blower.....	405	KNIGHT septum forceps.....	425
Iris tissue forceps BARRAQUER-KATZIN.....	384	KADER abdominal spatula.....	143/1	knives amputation.....	44
Iris tissue forceps BISHOP-HarmAN.....	386	KALLMORGEN specula.....	573	knives BALLENGER.....	436
Iris tissue forceps BONN.....	387	KALT capsular forceps.....	391	knives bone.....	44
Iris tissue forceps FISCHER.....	384	KALT needle holder.....	214	knives LANGENBECK.....	47
Iris tissue forceps FOERSTER.....	383	KALT needle holder.....	214	knives MUCK.....	420
Iris tissue forceps GILL.....	384	KALT needle holder.....	214	knives PLESTER.....	418
Iris tissue forceps GILL-HESS.....	384	KALT-ARRUGA needle holder.....	214	knives ROSEN.....	418
Iris tissue forceps GRAEFE.....	382	KANE navelstringclamp.....	605	knives SCHUKNECHT.....	418
Iris tissue forceps HESS.....	384	KANTROWITZ hemostaticL.....	119	knives TABB.....	418
Iris tissue forceps KIRBY-ARTHUR.....	385	KAYE FACE LIFT scissors.....	73	knives WULLSTEIN.....	418
Iris tissue forceps ModELL BONN.....	387	KEINSASSER OP-laryngoscope.....	35	KNOWLES bandage scissors.....	70
Iris tissue forceps TROUTMAN.....	384; 389	KEITH needle.....	223	KOCHER bladder spatula.....	552
Iris tissue forceps type TUEBINGEN.....	387	KELLY GRIP retractor.....	142	KOCHER hemostatic clamp.....	108
Iris tissue forcepsSTEVENS.....	383	KELLY hemostatic clamp.....	106	KOCHER intestinal clamp.....	540
irrigation cannula EICKEN (KILLIAN).....	433	KELLY hook.....	193	KOCHER probes.....	479
irrigation cannula KILLIAN.....	433/1	KELLY proctoscope.....	562, 563	KOCHER retractor.....	155, 160, 163
irrigation cannula KILLIAN.....	433/1	KELLY retractor.....	164	KOCHER-LANGENBECK retractor.....	159
irrigation cannula RITTER-HALLE.....	433	KELLY uterine polyp forceps.....	585	KOENIG needle.....	223
irrigation cannula SIMCOE.....	394/2	KELLY vascular scissors.....	61	KOERTE abdominal spatula.....	143/3
Irrigations cannula type LACRIMAL.....	394	KELLY-RANKIN hemostatic clamp.....	106	KOERTE retractor.....	162
ISRAEL retractor.....	162	Keratoplast.-knives BARRAQUER.....	373	KOGAN endo specula.....	577
ITERSON trachea hook.....	477	Keratoplast.-knives PAUFIQUE.....	373	KÖNIG bone levers.....	284
IVES-FANSLER anoscope.....	562	KERN bone holding forceps.....	244	KÖNIG guideprobes.....	221/1



KÖNIG raspatories .....276  
 KÖNIG retractor.....153  
 KOOS dura knives.....335  
 KRAUSE interchangeable tips.....472  
 KRAUSE polyp snare .....433/2  
 KRAUSE polyp snare .....411, 434  
 KRAUSE-VOSS polyp snare .....433/2  
 KRAYENBÜHL nerve hook.....336  
 KRISTELLER specula .....572  
 KRISTELLER vaginal specula.....572  
 KROENIG tongue depressors .....451  
 KRONECKER ligaturee needle .....219  
 KUGLEN hook.....376  
 KÜMME abdominal spatula .....143/4, 144  
 KÜNTSCHER driver.....321  
 KÜNTSCHER extractor.....322  
 KÜNTSCHER reamer.....321  
 K-wire dispenser .....310

**L**  
 LA FORCE adenoid curette.....450  
 LA FORCE foreign body needle.....374  
 LA GRANGE gum scissors.....69  
 LABORDE trachea dilator.....476  
 lachrymal dilat. WILDER.....381  
 lachrymal dilat.CASTROVIEJO.....381  
 lachrymal dilator ZIEGLER.....381  
 lachrymal probes BOWMAN.....381  
 lachrymal probes HarmS.....381  
 LACRIMAL Irrigationscannula .....394  
 LAGRANGE supercut scissors .....72  
 LAHEY grasping forceps .....479  
 LAHEY hemostatic clamp .....120  
 LAHEY retractor .....149, 157  
 LAMBERT chalazio tissue forceps .....393  
 LAMBERT-KAY aortic-ANASTOMosis clamp .....505  
 LAMBERT-LOWMAN bone holding clamp.....249  
 LAMBOTTE bone holding forceps .....244  
 LAMBOTTE chisels .....261  
 LAMBOTTE raspatories.....274, 275  
 lamina spreader CLOWARD .....339  
 lamina spreader INGE .....339  
 laminectomy retractor CHERRY.....488  
 laminectomy retractor forceps CLOWARD .....342  
 laminectomy retractor forceps OLDBERG .....341/1  
 laminectomy retractor forceps SCHLESINGER .....342  
 laminectomy retractor forceps SPURLING .....340  
 laminectomy retractor forceps WAGNER.....343  
 laminectomy retractor forcepsCUSHING .....340  
 laminectomy retractor forcepsFERRIS-SMITH.....343  
 laminectomy retractor forcepsLOVE-GRUENWALD .....340  
 laminectomy retractor SCOVILLE .....196  
 laminectomy retractor SCOVILLE-HAVERFIELD.....196  
 LANCASTER eye specula .....371  
 lancet electrode MONOPOLAR.....628, 629  
 LANDAU vaginal specula .....577  
 LANDOLT TUMOR grasping forceps .....341/2  
 LANE bender .....325  
 LANE bone holding forceps .....244  
 LANE bone levers.....290  
 Lane bone levers .....290  
 LANE bone plate holding forceps .....325  
 LANE screw driver.....323, 324  
 LANE srewholdingforceps .....325  
 LANE stomach clamp.....547  
 LANE surgical tissue forceps .....84  
 LANE towel clamp.....133  
 LANE TRETOWAN bone levers .....290  
 LANG extraction dissector.....378  
 LANGE interchangeable tips .....472  
 LANGE nose hook.....448  
 LANGE-HOHMANN.....286  
 LANGENBECK .....311, 409

LANGENBECK amputation knives.....44  
 LANGENBECK bone holding forceps .....243  
 Langenbeck ear loop .....409  
 LANGENBECK FINGER saw .....296  
 LANGENBECK knives .....47  
 LANGENBECK needle holder .....213  
 LANGENBECK raspatories.....275  
 LANGENBECK retractor.....158, 159  
 LANGENBECK-GREEN retractor .....153  
 LARSEN tendon grasping forceps .....292  
 laryngeal cannula .....470  
 laryngeal mirror.....473  
 laryngeal mirror MICHEL.....423  
 laryngeal polypus forceps FRAENKEL.....471  
 laryngeal polypus forceps JURASZ .....471  
 laryngoscope FOREGGER .....29, 31  
 laryngoscope handle cold light .....33  
 laryngoscope handle warm light .....32  
 laryngoscope handle with transformer.....34  
 laryngoscope HOLINGER.....37  
 laryngoscope JACKSON .....37  
 laryngoscope MCINTOSH.....29, 31  
 laryngoscope MILLER .....30  
 Lateral vaginal retractor.....569  
 LAWRENCE hemostatic clamp .....119  
 lead hand.....250  
 LEBSCHKE skull breaker.....267  
 LEES bronchus clamp.....504  
 LEGUE bladder retractors .....553  
 LEGUEU bladder spatula .....552  
 LEKSELL(STILLE) bone rongeur .....240  
 LELAND-JONES vascular clamp .....495  
 LEMPert bone curettes .....256  
 LEMPert bone rongeur.....237  
 LEMPert elevator .....420  
 LERICHE grasping tissue forceps .....83  
 LERICHE abdominal spatula .....143/4  
 LERICHE hemostatic clamp .....111  
 LESTER fixation forceps .....389  
 LEVINSON foreign body needle.....374  
 LEWIN bone holding forceps .....246  
 LEXER BABY dissecting scissors .....53  
 LEXER chisels .....263  
 LEXER dissecting scissors.....53  
 LEXER MINI gouges.....263  
 LEYLA holding arm system .....368 - 368/4  
 LICHTENBERG needle holder.....213  
 LICHTWITZ trocar .....204  
 LIEBERMAN eye specula .....324  
 ligature rings .....568  
 ligature scissors.....54  
 ligaturee needle .....218  
 ligaturee needle COOPER.....219  
 ligaturee needle DESCHAMPS .....218  
 ligaturee needle KRONECKER .....219  
 ligaturee needle NELSON.....219  
 ligaturee needle SCHMIEDEN-DICK .....219  
 light guide HOLLINGER .....37  
 light guide JACKSON .....37  
 lip retractor .....453  
 LISTER bandage scissors .....69/1  
 LISTER SUPERCUT scissors .....72  
 LISTER(SINUS) dressing forceps .....137  
 LISTER-BURCH eye specula .....370  
 LISTON amputation knives .....44  
 LISTON bone cutting forceps .....241  
 LITTAUER cilia forceps .....395  
 LITTAUER ear forceps .....411  
 LITTAUER polyp forceps .....425  
 LITTAUER suture scissors .....66  
 LITTLE retractor.....157  
 LITTLE IRIS scissors .....55  
 LITTLEWOOD intestinal grasping forceps .....538

LOCKHART-MUMMERY fistula probes.....200  
 LOCKLIN gum scissors.....69  
 LOCKWOOD-ALLIS intestinal grasping forceps .....538  
 LONDON-COLLEGE teeth tissue forceps.....93  
 loop electrode MONOPOLAR .....628, 629  
 LOPEZ-REINKE tonsil .....465  
 LORENZ bandage scissors.....70  
 LORNA towel clamp.....133  
 LOUTE wire instrument .....315  
 LOVE nerve hook .....329, 330  
 LOVE retractor.....465  
 LOVE-GRUENWALD .....340  
 LOVELACE hemostatic clamp.....109  
 LOVELACE lung grasping forceps .....490  
 LOWER hemostatic clamp .....120  
 LOWMAN bone holding clamp .....249  
 LOWMAN-HOGLUND bone holding clamp .....249  
 LUBET-BARBON nose dressing forceps.....424  
 LUC septum forceps .....426  
 LUCAE ear forceps.....410  
 LUCAE hook .....409  
 LUCAE mallet .....271  
 LUCAE paracentesis needle .....408  
 LUCAE tuning forc. ....404  
 LUCAS .....260  
 LUER bone rongeur .....236  
 LUER retractor.....140  
 LUER trachea cannula.....479  
 LUER-KOERTE gall stone curette .....533  
 LUIKART obstetrical forceps.....603  
 LUNDSGAARD SKLEROTOM .....373  
 lung grasping forceps LOVELACE .....490  
 lung scissors CRAFOORD .....65/2  
 lung spatula ALLISON .....489/2  
 LUNIATSCHKE .....465  
 Lupus curette FOX .....608  
 Lupus curette PIFFARD.....608

**M**  
 MAGILL CATETHER INTRODUCING FORCEPS .....28  
 MAIER dressing forceps.....134  
 MAINGOT hysterectomy forceps.....123/1, 123/2  
 mallet .....270, 272  
 mallet BERGMANN .....272  
 mallet COLLIN .....270  
 mallet COTTLE .....273  
 mallet GERZOG .....270  
 mallet HAJEK .....273  
 mallet HEATH .....273  
 mallet KIRK.....270  
 mallet LUCAE .....271  
 mallet MEAD.....271  
 mallet OMBREDANNE .....273  
 mallet PARTSCH .....271  
 mallet QUISLING .....271  
 mallet WILLIGER .....271  
 MALTZ (COTTLE) nose rasp .....444  
 MALTZ nose rasp .....443  
 mamaria sternum retractor.....486  
 mandibular body retractor HARGIS.....463/6  
 MANDRIN for tourniquet .....528  
 MANOMETER.....295, 596  
 marker CONNIN-AMSLER .....380  
 MARQUARD bone rongeur .....239  
 MARSCHIK tonsil forceps .....468  
 MARTEL grasping forceps .....110  
 MARTIN bone holding forceps .....246  
 MARTIN CARTILAGE scissors .....65/1  
 MARTIN pelvimeter .....605  
 MARTIN retractor .....175/1  
 MARTIN uterine-probes .....586  
 MARTINI bone curettes .....257  
 MASING septum elevator.....437

MASSING-NEIVERT nose hook .....	447/1	METZENBAUM TC dissecting scissors .....	53/1	MORITZ-SCHMIDT tongue depressors .....	452
MASSON needle holder .....	210	MEYER bone holding forceps .....	248	MORRIS retractor .....	164
MASTIN muscle clamp .....	479	MEYERDING retractor .....	157	MORRIS-DEBAKEY aortic clamp .....	506
MATHIEU foreign body forceps .....	553/1	MEYERDING retractors .....	180	MORSE rib spreader .....	484
MATHIEU needle holder .....	213	MEYHOEFER chalazio curette .....	377	MORSE-FAVALORO rib spreader .....	484
MATHIEU rectal-specula .....	560	MICHEL clip .....	224	mouth gags DAVIS-BOYLE .....	455
MATHIEU retractor .....	141	MICHEL clip forceps .....	224	mouth gags DENHART .....	454
MATHIEU-OLSEN needle holder .....	212	MICHEL clip tissue forceps .....	224	mouth gags DINGMANN .....	456
MATSON raspatories .....	279	MICHEL laryngeal mirror .....	423	mouth gags HEISTER .....	454
MATSON-ALEXANDER raspatories .....	279	micro ear forceps .....	413	mouth gags JENNINGS .....	454
MAXI GRASPER biopsy forceps .....	593	micro ear forceps COS .....	414	mouth gags McIVOR .....	457
MAYFIELD bone rongeur .....	238	micro ear forceps DIETER .....	414	mouth gags ROSER-KOENIG .....	454
MAYO dissecting scissors .....	52	micro ear forceps GREVEN .....	414	mouth gags DOYEN-JANSEN(MOLT) .....	454
MAYO gall stone curette .....	534	micro ear forceps HAUGH .....	414	MOYNIHAN gall stone probes .....	531
MAYO gall stone probes .....	534	micro ear forceps JUERS .....	414	MOYNIHAN hemostatic clamp .....	121
MAYO sterilization clamp .....	227	micro ear forceps McGEE .....	414	MOYNIHAN towel clamp .....	133
MAYO supercut scissors .....	71	micro ear scissors BELLUCCI .....	413	MUCK knives .....	420
MAYO tissue forceps .....	89	micro ear scissors SHEA .....	413	MUELLER eye specula .....	371
MAYO tongue depressors .....	451	MICRO FRIEDMANN .....	234	MÜLLER APPROXIMATOR .....	364
MAYO-ADAMS retractors .....	171	MICRO FRIEDMANN bone rongeur .....	234	MÜLLER vascular clip .....	365
MAYO-BLAKE gall stone forceps .....	530/2	micro scissors .....	76, 77, 78, 80	MÜNCHEN biopsy curette .....	587
MAYO-COLLINS retractor .....	141	micro scissors BELLUCCI .....	417	MURDOCK eye specula .....	370
MAYO-COLLINS retractor Set .....	141	micro scissors GOMEL .....	80	MURPHY retractor .....	156
MAYO-HABERISSER wire forceps .....	319	micro scissors HEPP-SCHIEDL .....	78	MURPHY-LANE elevator .....	283
MAYO-HEGAR needle holder .....	209	micro scissors REDA .....	77, 78, 80	muscle clamp MASTIN .....	479
MAYON-GUYON hemostatic clamp .....	122	micro sickle knives .....	475	muscle forceps PRINCE .....	387
MAYO-NOBLE dissecting scissors .....	52	micro tissue forceps .....	94	musclehook .....	267
MAY-OPHTHALMOSKOP UNI .....	14	micro-curette forceps WULLSTEIN .....	416	musclehook GREEN .....	375
MAYO-ROBSON intestinal clamp .....	541	micro-grasping forceps tube shaft .....	415	muscle forceps BERKE .....	389
MAYO-STILLE dissecting scissors .....	52	MICRO-HARTMANN hemostatic clamp .....	104	MUSEUX hook forceps .....	583
MAYO-STILLE supercut scissors .....	71	microsurgical tissue forceps GOMEL .....	96	MYLES nose forceps .....	427
MC DONALD elevator .....	283	MICROVASCULAR needle holder .....	210	myoma knives SEGOND .....	594
MC GIVNEY haemorrhoidal LIGATOR .....	568	MIDDELDORPF retractor .....	160	myoma screw DOYEN .....	594
MC INDOE bone cutting forceps .....	241	MIDDLETON-JANSEN septum forceps .....	430	N	
MC KENZIE drill .....	299	MIKULICZ intestinal clamp .....	543	NABATOFF varicose vein probes .....	201
MCCULLOUGH strabismus forceps .....	385	MIKULICZ peritoneum clamp .....	123	NAEGELE obstetrical forceps .....	603
MCGEE hook .....	419	MIKULICZ retractor .....	163	NAGER retractor .....	465
MCGEE micro ear forceps .....	414	MIKULICZ-BABY peritoneum clamp .....	123	NAGER tonsil needle .....	466
MCINDOE scissors .....	65/1	MILLER laryngoscope .....	30	nail brushes .....	611
MCINDOE tissue forceps .....	85	MILLER nose rasp .....	444	nail drill .....	297
MCINTOSH laryngoscope .....	29, 31	MILLIGAN dura dissector .....	332	nail files .....	612/1
MCINTYRE eye cannula .....	394	MILLIN bladder retractors .....	552	nail forceps .....	609, 613
MCIVOR mouth gags .....	457	MILLIN bladder spreader .....	553	nail forceps Anvil .....	613
MCKENTY septum elevator .....	437, 438	MILLIN capsular grasping forceps .....	551	nail forceps Radolf .....	297
MCKENZIE applier forceps .....	326	MILLIN prostatic grasping forceps .....	551	nail forceps TURNBULL .....	609
MCLEAN obstetrical forceps .....	603/1	Mini bulldog clamp DEBAKEY-DIETHRICH .....	101	nail impactor .....	322/1
MCLEAN-LUIKART obstetrical forceps .....	603/1	Mini quick handle .....	301	nail nippers .....	612/2, 613, 614
MCLEAN-TUCKER-LUIKART obstetrical forceps .....	603/1	mini scalpel .....	41	nail rasp .....	610
MCPHERSON tissue forceps .....	392	mini scalpel handle .....	41	nail scissors .....	609
MEAD bone rongeur .....	235	Mini-bulldog clamp .....	101	nail SET .....	609
MEAD mallet .....	271	MINI-LAMBOTTE chisels .....	262	nail skin forceps .....	613
Measurement circle CASTROVIEJO .....	380	MINIMUS Sphygmomanometer .....	11, 12	nail skin forceps .....	610, 613
Measuring instrument IWANSON .....	624	MINI-TOWNSEND-DOWN biopsy forceps .....	591	Nail splitting scissors .....	614
medicine cup .....	621	MINI-TOWNSEND-UP biopsy forceps .....	591	needle BARBARA .....	419
medicine spoon .....	621	MIXTER gall stone forceps .....	530/2	needle electrode MONOPOLAR .....	628, 629
MEEKER hemostatic clamp .....	119	MIXTER hemostatic clamp .....	116, 119, 120, 121	needle guide IOWA .....	206
MEHDORN applier forceps .....	362	MIXTER hemostatic clamp S-cvd .....	116	needle holder ADSON .....	211
MEHDORN vascular clip .....	362	MIXTER-BABY hemostatic clamp .....	119	needle holder ARRUGA .....	214
MELLINGER eye specula .....	370	MIXTER-O'SHAUGNESSY .....	120	needle holder BABY-OLSEN-HEG .....	212
MELLINGER-AXENFELD eye specula .....	370	MIXTER-O'SHAUGNESSY hemostatic clamp .....	120	needle holder BABY-WEBSTER .....	208
MENGHINI biopsy needle .....	206	MODELL BONN iris tissue forceps .....	387	needle holder BARRAQUER .....	217
meniscus hook BLOUNT .....	289	MOELTGEN goniometer .....	25	needle holder BARRAQUER Micro .....	216
meniscus knives NEFF .....	292	MOGEN circumcision instrument .....	556	needle holder BAUMGARTNER .....	208
meniscus knives SMILLIE .....	292	MOLLISON retractors .....	171	needle holder BOYNTON .....	214
MERCEDES thoracic spreader .....	489	MOLT raspatories/LUM .....	276	needle holder BOZEMANN .....	211
MERIAM teeth tissue forceps .....	93	MONOPOLAR electrode ball .....	628, 629	needle holder BROWN .....	209
METAL catheter .....	555	MONOPOLAR electrode lancet .....	628, 629	needle holder CASTROVIEJO .....	215
Metal catheter COXETER .....	555	MONOPOLAR electrode loop .....	628, 629	needle holder Castroviejo .....	216
METZENBAUM "S" surgical scissors .....	54	MONOPOLAR electrode needle .....	628, 629	needle holder CASTROVIEJO Micro .....	215
METZENBAUM dissecting scissors .....	53/1	MOOR gall stone scoop .....	531	needle holder cheek/STEEN .....	210
METZENBAUM FINO TC dissecting scissors .....	53/1	MOORE bone hand drills .....	298	needle holder COLLIER .....	208
METZENBAUM needle holder .....	211	MOORFIELD tissue forceps .....	392	needle holder CRILE .....	213
METZENBAUM supercut scissors .....	71	MORGAN proctoscope .....	565		

needle holder CRILE-MURRAY .....	209	nose forceps SCHMEDEN .....	427	OLIVECRONA dura dissector.....	332
needle holder CRILE-WOOD TC.....	209	nose forceps STRUYCKEN.....	427	OLIVECRONA wire saw.....	332
needle holder DE BAKEY .....	210	nose forceps TAKAHASHI.....	427	OLIVECRONA-TOENNIS applier forceps.....	326
needle holder DERF .....	208	nose forceps WATSON-WILLIAMS .....	428	OLLIER retractor.....	162
needle holder FINOCCHIETTO .....	211	nose forceps WEIL-BLAKESLEY .....	426	OLSEN-HEGAR needle holder.....	212
needle holder GILLIES .....	212	nose hook.....	447	OMBREDANNE mallet.....	273
needle holder HALSEY .....	208	nose hook AUFRICHT .....	447	Opthalmoskop MAY UNI II.....	14
needle holder HALSEY .....	208	nose hook CONVERSE .....	448	OP-laryngoscope HOLINGER.....	37
needle holder HEANEY .....	210	nose hook COTTLE .....	447, 447/1	OP-laryngoscope JACKSON.....	37
needle holder HOESEL.....	213	nose hook LANGE .....	448	OP-laryngoscope KLEINSASSER .....	35
needle holder JACOBSON .....	215	nose hook MASING-NEIVERT.....	447	ophthalmologic scissors .....	57, 58
needle holder JOHNSON .....	211	nose rasp FOMON .....	444, 445	ophthalmologic scissors AEBLI .....	58
needle holder KALT-ARRUGA.....	214	nose rasp JOSEPH.....	443	ophthalmologic scissors GRADLE .....	57
needle holder KILNER .....	212	nose rasp JOSEPH (LEWIS).....	443	ophthalmologic scissors STEVENS .....	58
needle holder LANGENBECK .....	213	nose rasp MALTZ .....	443	Oscillation plaster cast saw and accessories.....	230/10 - 230/18
needle holder LICHTENBERG.....	213	nose rasp MALTZ (COTTLE).....	444	osteotome blade OBWEGESER .....	464/1
needle holder MASSON.....	210	nose rasp MILLER.....	444	osteotome EPKER.....	464/2
needle holder MATHIEU .....	213	nose rasp PEET .....	446	OSTROEM Antrum-punch.....	430
needle holder MATHIEU-OLSEN.....	212	nose rasp WIENER.....	443	O'Sullivan-O'Connor abdominal retractor.....	181
needle holder MAYO-HEGAR.....	209	nose saw JOSEPH .....	446	O'SULLIVAN-O'CONNOR abdominal retractor.....	576
needle holder METZENBAUM.....	211	nose scissors.....	429	O'SULLIVAN-O'CONNOR abdominal retractors.....	181
needle holder MICROVASCULAR .....	210	nose scissors COTTLE .....	58	OTIS urethrotome.....	553
needle holder NEIVERT .....	208	nose scissors FOMON .....	58	Otoskope Diagnostic set UNI I.....	13
needle holder OLSEN-HEGAR .....	212	nose scissors HEYMANN.....	58	OVAL RING.....	194
needle holder RYDER.....	210	nose specula COTTLE .....	423	OVERHOLT hemostatic clamp.....	114
needle holder SAROT.....	211	nose specula HARTMANN.....	422	OVERHOLT-BABY hemostatic clamp.....	114
needle holder STEVENS.....	214	nose specula HARTMANN-HALLE.....	421	OVERHOLT-GEISENDOERFER hemostatic clamp.....	114
needle holder STRATTE .....	212	nose specula KILLIAN .....	423	OVERHOLT-MIXTER hemostatic clamp.....	115
needle holder WEBSTER.....	208	nose specula REDA.....	423	ovum curette CUZZI.....	606
needle nose plier.....	320	nose specula THUDICHUM .....	421	ovum curette PESTALOZZA .....	606
needle REVERDIN.....	220	nose specula TIECK-HALLE .....	423	ovum curette WALLICH.....	607
needle ROSEN .....	419	nose specula type VIENNA .....	421	ovum forceps SAENGER.....	606
needle sterilization case .....	615	nose specula VOLTOLINI .....	421	ovum forceps WINTER.....	606
needle YOUNG-BOOMERANG .....	220	noseolive POLITZER .....	406		
needles.....	222, 223	NOTO uterine polyp forceps .....	585		
NEFF meniscus knives.....	292	NOVA Sphygmomanometer .....	6, 7	P	
Negus CHEST SUPPORT .....	459	NOVAK biopsy curette .....	587	pan bed .....	621/1
NEIVERT needle holder.....	208	NOYES eye scissors .....	75	pan placenta .....	621/1
NEIVERT-ANDERSON chisel.....	442	NOYES polyp forceps .....	425	paracentesis needle LUCAE .....	408
NELATON probes .....	199	Nucleus Rotator Bechert .....	379	paracentesis needle POLITZER .....	408
NELSON ligaturee needle.....	219	nystagmus spectacles FRENZEL.....	20	parametrium clamp REDA .....	128/1
NELSON STANDARD trocar.....	204			PARAMETRIUM scissors.....	63
NELSON trocar.....	205			PARK eye specula .....	371
NELSON vascular tissue forceps .....	89	O		PARKER retractor .....	139
NEONATAL vascular clamp .....	523	obstetrical curette SELLHEIM.....	607	PARTSCH chisels .....	259
Neonatal vascular clamp CASTANEDA .....	527	obstetrical forceps BARTON .....	603/2	PARTSCH mallet.....	271
nerve hook CRILE .....	328	obstetrical forceps BOERMA .....	604	PASSOW.....	260
nerve hook CUSHING .....	328	obstetrical forceps DE LEE .....	602	Passow chisels.....	260
nerve hook DANDY .....	328	obstetrical forceps ELLIOT.....	603	PATELLA forceps.....	248
nerve hook GRAHAM .....	328	obstetrical forceps KIELLAND.....	602	PATON corneal dissector .....	373
nerve hook HOLSHER.....	329	obstetrical forceps KIELLAND-LUIKART .....	603	PAUFIQUE Keratoplast.-knives.....	373
nerve hook KRAYENBUEHL.....	336	obstetrical forceps LUIKART.....	603	PAUFIQUE tissue forceps .....	392
nerve hook LOVE .....	329	obstetrical forceps McLEAN .....	603/1	PAYR guide probes .....	221/1
nerve hook LOVE .....	330	obstetrical forceps McLEAN-LUIKART .....	603/1	PAYR intestinal clamp .....	548
nerve hook SACHS.....	328	obstetrical forceps McLEAN-TUCKER.....	603/1	PEAN hemostatic clamp .....	108
nerve hook SCOVILLE .....	329, 330	obstetrical forceps McLEAN-TUCKER-LUIKART .....	603/1	PEAN hemostatic clamp .....	110
nerve hook SMITHWICK .....	328	obstetrical forceps NAEGELE .....	603	PEAN hemostatic clamp .....	108, 110
NEUGS tonsil forceps .....	467	obstetrical forceps PIPER .....	604	PEAPOD rongeur.....	341/1
neurosurgical SCISSOR STRULLY.....	65	obstetrical forceps SIMPSON.....	602	PECK-JOSEPH dissecting scissors.....	74
neurosurgical scissors.....	65	obstetrical forceps SIMPSON-BRAUN.....	602	PEDERSON vaginal specula .....	570
NEWS trachea hook.....	477	obstetrical forceps SIMPSON-LUIKART.....	603	PEENFIELD dissector.....	333
nippers nail.....	612/2, 613, 614	obstetrical forceps THIERRY .....	603	PEERS towel clamp .....	132
Nissen fine hemostatic clamp.....	113	obstetrical forceps WRIGLEY .....	602	PEET nose rasp .....	446
NISSEN hemostatic clamp.....	113	OBWEGESER awl.....	463	PEET splinter forceps .....	92
nmonopolar forceps.....	634	OBWEGESER blade osteotome .....	464/1	PELKMANN dressing forceps .....	137
noise appartus POLITZER.....	405	OBWEGESER raspatories.....	462	pelvimeter COLLIER.....	605
NORFOLK-NORWICH retractors.....	172	OBWEGESER retractor.....	460, 461/1	pelvimeter MARTIN .....	605
NORTHBENT suture scissors.....	66	OBWEGESER retractors .....	463	Pelvis-hook St.MARKS.....	165
nose dressing forceps LUBET-BARBON .....	424	OCHSNER trocar.....	205	Penisclamp Stockmann .....	553/1
nose dressing forceps WESTMACOTT .....	424	O'CONNOR iris hook.....	375	Penisclamp STRAUSS .....	553/1
nose forceps CAPLAN .....	428	OEHLER surgical tissue forceps.....	81/1	PENNINGTON hemostatic clamp .....	109
nose forceps HARTMANN.....	427	OLDBERG laminectomy retractor forceps.....	341/1	PENNINGTON septum elevator .....	438
nose forceps MYLES.....	427	OLIVECRONA bone rongeur .....	237	percussion mallet BABINSKY .....	24
		OLIVECRONA brain spatula .....	336		

percussion mallet BERLINER.....	24	PRATT fistula probes.....	563	raspatoriesium WIBERG.....	277
percussion mallet BUCK.....	24	PRATT grasping forceps.....	110	raspatoriesSEDLLOT.....	274, 275
percussion mallet TAYLOR.....	24	PRATT hook forceps.....	584	raspatory HARGIS.....	463/2
percussion mallet TROEMNER.....	24	PRATT rectal-specula.....	559	raspatory SELDING.....	277
PERCY RETRAKTOR.....	296	PRATT uterine Dilatatator.....	580	RAZOR blades.....	45
perforators SMELLIE.....	607	PRECISA Sphygmomanometer.....	9	reamer KUENTSCHER.....	321
Peripheral vascular clamp DE BAKEY.....	494	PRICE-THOMAS bronchus clamp.....	490	reamer KUENTSCHER.....	321
Peripheral vascular clamp LELAND-JONES.....	495	PRINCE muscle forceps.....	387	RECAMIER uterine curette.....	597
peritoneum clamp FAURE.....	123	PRINCE tonsil scissors.....	59	rectal biopsy forceps TURREL.....	567
peritoneum clamp MIKULICZ.....	123	PROBE AND PACKER.....	612	rectal suction tube BUIE.....	566
peritoneum clamp MIKULICZ-BABY.....	123	probe tips.....	201	rectalbiopsy forceps YEOMAN.....	566, 567
peritoneum clamp PHANEUF.....	123	probes.....	199	rectalsnare WESTON.....	566
PERKINS retractors.....	168	probes BRODIE.....	199	rectal-specula ALAN-PARKS.....	561
PERTHES awl.....	304	probes DOYEN.....	199	rectal-specula BARR.....	559
PESTALOZZA ovum curette.....	606	probes FISH.....	199	rectal-specula BODENHAMMER.....	559
petri box.....	620	probes Harms.....	333	rectal-specula CZERNY.....	559
PETZ stomach and intestinal suturing apparatus.....	549	probes JACOBSON.....	335	rectal-specula HILL-FERGUSSON.....	560
PHALANGEN knives.....	44	probes KOCHER.....	479	rectal-specula MATHIEU.....	560
PHANEUF peritoneum clamp.....	123	probes NELATON.....	199	rectal-specula PRATT.....	559
PIERCE septum.....	438	probes Valleix.....	586	rectal-specula SAWYER.....	560
PIERCE trocar.....	204	probes WATSON-CHEYNE.....	199	rectal-specula SCHULZE-BERG.....	560
PIFFARD LUPUS curette.....	608	probes Worst.....	333	rectal-specula SIMS.....	559
PILLING clip forceps.....	524	proctoscope Bensaude.....	565	rectum clamp HAYES.....	545
pin cutter.....	320	proctoscope CHELSEA-EATON.....	563	REDA tuning forc.....	403
PINARD stethoscope.....	23	proctoscope FANSLER.....	564	REDA amputation knife.....	44
PINWHEEL WARTENBERG.....	25	proctoscope KELLY.....	562, 563	REDA blade breaker.....	45
PIPER obstetrical forceps.....	604	proctoscope Morgan.....	565	REDA bone currettes.....	256
Pistol for cleaning.....	626	proctoscope MILLIN.....	551	REDA bone hand drills.....	300
pituitary rongeur.....	341	prostatic grasping forceps MILLIN.....	551	REDA bone holding forceps.....	246, 247
placenta pan.....	621/1	prostatic hook YOUNG.....	550	REDA bone holding forceps.....	246, 247
plaster cast saw ENGEL.....	229	PROVIDENCE-HOSPITAL hemostatic clamp.....	106	REDA cilia forceps.....	395
plaster cast saw oscillating and accessories.....	230/10 - 230/18	punch KEYES.....	608	REDA cotton-applicator.....	203
plaster forceps WOLFF.....	233	punch KEYES.....	608	REDA EXCENTER bandage scissors.....	69/2
plaster knives ESMARCH.....	233	puncture cannula FRAZIER.....	337	REDA eye magnet.....	395
plaster knives HOPKINS.....	233	puncture cannula QUINKE.....	206	REDA Finger ring saw.....	297
plaster knives REINER.....	233	PUTTI bone rasp.....	294	REDA intestinal grasping forceps atrauma.....	111
plaster knives WIGMORE.....	229	Pylorusretractor BENSON.....	544	REDA nose specula.....	423
plaster retractor BEESON.....	232	Q		REDA parametrium clamps.....	128/1
plaster retractor HAGLUND-STILLE.....	232	QUERVAIN elevator.....	275	REDA plaster retractor.....	232
plaster retractor HENNIG.....	232	quick handle.....	301	REDA sickle knives.....	435
plaster retractor REDA.....	232	QUINBY gum scissors.....	67	REDA skin hook.....	150
plasterscissorsSTILLE.....	229	QUINKE punctum cannula.....	206	REDA sterilization forceps.....	615
platte JAEGER.....	371	QUIRE foreign body lever.....	412	REDA suture fork.....	221/1
PLESTER knives.....	418	QUISLING mallet.....	271	REDON guide needle.....	207
PLESTER retractors.....	171	R		REES FACE LIFT scissors.....	73
PLESTER suction tube.....	338	RACHOTOM.....	267	REICHERT DECKEL epiglottis retractor.....	471
pneumatic tournique.....	295	RADOLF nail forceps.....	297	REILL bone holding forceps.....	248
POLITZER air blower.....	406	RALK bone hand drills.....	300	REINER ear syringe.....	406
POLITZER ear knives.....	408	RAMPLEY dressing forceps.....	136	REINER plaster knives.....	233
POLITZER ear specula.....	399	RAMUS retractor.....	461	REKORD syringe.....	596
POLITZER noseOLIVE.....	406	RANDALL biopsy curette.....	587	RESANO capsula scissors.....	53/2
POLITZER paracentesis needle.....	408	RANDALL kidney stone forceps.....	535	RESANO intestinal clamp.....	542
polyp forceps HARTMANN.....	424	RANEY appling forceps.....	327	RESECTION knives.....	47
polyp forceps LITTAUER.....	425	RANGELL retractor.....	140	retractor ALM.....	168
polyp forceps NOYES.....	425	raspatories.....	279	retractor ANDERSON.....	198
polyp loop.....	411	raspatories ADSON.....	282	retractor assembly.....	188
polyp snare KRAUSE.....	433/2	raspatories ALEXANDER.....	276	retractor AUFRANC.....	289
polyp snare KRAUSE.....	411, 434	raspatories COBB.....	280	retractor breast.....	198
polyp snare KRAUSE-VOSS.....	433/2	raspatories DINGMANN.....	463, 463/3	retractor BRUNNER.....	167
polyp snare WILDE.....	433/2	raspatories DOYEN.....	278	retractor COLLIN.....	139
polyp snare WILDE.....	411, 434	raspatories FARABEU.....	274	retractor COLLIN HARTMANN.....	141
POOLE suction tube.....	27	raspatories FARABEU.....	274	retractor COOLEY.....	148
POST MORTEM.....	268	raspatories FARABEU-COLLIN.....	274	retractor CORONAL BLOW LIFT.....	198
POST MORTEM knives.....	48	raspatories FOMON.....	277	retractor CORYLLOS.....	166
POST MORTEM knives VIRCHOW.....	48	raspatories JOSEPH.....	277	retractor CRILE.....	140
post mortem set.....	269	raspatories KOENIG.....	276	retractor CUSHING.....	151
POTTS SMITH tissue forceps.....	81	raspatories LAMBOTTE.....	274	retractor CZERNY.....	141
POTTS-DE MARTEL vascular scissors.....	59	raspatories LANGENBECK.....	275	retractor DAVIDSON (Scapula).....	166
POTTS-SMITH tissue forceps.....	81	raspatories MATSON.....	279	retractor DEEVER.....	145
POTTS-SMITH vascular scissors.....	61	raspatories MATSON-ALEXANDER.....	279	retractor DEEVER GRIP.....	146
POZZI-PALMER tenaculum forceps.....	582	raspatories OBWEGESER.....	462	retractor DEBAKEY.....	189/1
		raspatories SEMB.....	278	retractor DELEE.....	574
		raspatories WILLIGER.....	276	retractor DESMARRES.....	151
		raspatoriesium MOLT.....	276	retractor DESMARRES.....	151

retractor DOYEN.....	163	retractors BECKMANN.....	176	rongeur HAJEK-KOFLER.....	429, 431
retractor DOYEN-STILLE.....	167	retractors BECKMANN-ADSON.....	175	rongeur HOLTH.....	380
retractor FARABEUF.....	139	retractors BECKMANN-EATON.....	176	rongeur KERRISON.....	428
retractor FERRIERA.....	197	retractors CASPAR.....	179, 180	rongeur PEAPOD.....	341/1
retractor FINSEN.....	168	retractors DARLING.....	178	ROSE retractor.....	140
retractor Freeman.....	198	retractors HENLEY.....	170	ROSEN knives.....	418
retractor FRITSCH.....	163	retractors MAYO-ADAMS.....	171	ROSEN needle.....	419
retractor GIL-VERNET.....	152	retractors MEYERDING.....	180	ROSEN suction tube.....	338
retractor GOELET.....	141	retractors MOLLISON.....	171	ROSER-KOENIG.....	454
retractor GREEN.....	160	retractors NORFOLK NORWICH.....	172	ROSS retractor.....	148/1
retractor HARRINGTON.....	147	retractors PERKINS.....	168	ROUND RING MEDIUM.....	194
retractor HARRINGTON-PEMBERTON.....	147	retractors PLESTER.....	171	ROUX MINI retractor.....	140
retractor HASSON.....	143	retractors SCALP-CONTOUR.....	169	ROUX retractor.....	139
retractor HEANEY.....	164	retractors TRAVERS.....	172	ROUX-BABY retractor.....	140
retractor HIBBS.....	164	retractors WEITLANER.....	169	ROWE reposition forceps.....	459
retractor HOESEL.....	167	retractors WULLSTEIN.....	171	RUBIN septum forceps.....	428
retractor HOFER.....	465	Retraktor PERCY.....	296	RUDD haemorrhoidal ligator.....	568
retractor HOLZHEIMER.....	168	REVERDIN intestinal spatula.....	143/3	ruler metal.....	25
retractor ISRAEL.....	162	REVERDIN needle.....	220	RUMEL hemostatic clamp.....	117
retractor JACKSON-BURROWS.....	189/2	REYNOLDS supercut scissors.....	72	RUMEL-BELMONT tourniquet.....	528
retractor JANSEN.....	168	REYNOLDS surgical scissors.....	54	RuSkin bone rongeur.....	239
retractor KELLY.....	164	rhinoplastic scissors FOMON.....	65/1	RuSkin-LISTON bone cutting forceps.....	241
retractor KELLY GRIP.....	142	rib contractor SELLORS.....	489/1	RUSS MODELL grasping tissue forceps.....	85
retractor KLAPP.....	150	rib scissors.....	480	RUSSEL-DAVIS mouth gage.....	458
retractor KOCHER.....	155	rib scissors BETHUNE.....	481	RYDEL-SEIFFERT tuning forc.....	404
retractor KOCHER.....	160, 163	rib scissors BRUNNER.....	481	RYDER needle holder.....	210
retractor KOCHER-LANGENBECK.....	159	rib scissors CORYLLOS.....	480		
retractor KOERTE.....	162	rib scissors GIERTZ-STILLE.....	481		
retractor KÖNIG.....	153	rib scissors GLUCK.....	480		
retractor LAHEY.....	157	rib scissors SAUERBRUCH.....	481		
retractor LANGENBECK.....	158, 159	rib scissors SAUERBRUCH-FREY.....	481		
retractor LANGENBECK-GREEN.....	153	rib scissors STILLE.....	480		
retractor LITTLE.....	157	rib spreader BAILEY.....	489/1		
retractor LOVE.....	465	rib spreader BAILEY-BABY.....	489/1		
retractor MARTIN.....	175/1	rib spreader BAILEY-GIBBON.....	489/1		
retractor MATHIEU.....	141	rib spreader COOLEY.....	487		
retractor MEYERDING.....	157, 177	rib spreader COOLEY-NEONATAL.....	485		
retractor MEYERDING.....	177	rib spreader DE BOER.....	486		
retractor MIDDELDORFF.....	160	rib spreader FINOCHIETTO.....	482, 484		
retractor MIKULICZ.....	163	rib spreader FINOCHIETTO-BURFORD.....	483		
retractor MORRIS.....	164	rib spreader HAIGHT.....	487		
retractor MURPHY.....	156	rib spreader MORSE.....	484		
retractor NAGER.....	465	rib spreader MORSE-FAVALORO.....	484		
retractor OBWEGESER.....	460, 461/1	rib spreader RIENHOFF-FINOCHIETTO.....	486		
retractor OLLIER.....	162	rib spreader TUFFIER.....	487		
retractor PARKER.....	139	RIBBON intestinal spatula.....	143/1		
retractor RAGNELL.....	140	RICARD abdominal retractor.....	191		
retractor RAMUS.....	461	RICHARDSON retractor.....	142		
retractor RICHARDSON.....	142	RICHARDSON-EASTMAN retractor.....	142		
retractor RICHARDSON GRIP.....	142	RICHARDSON-GRIP retractor.....	142		
retractor RICHARDSON-EASTMAN.....	142	RICHNAU-HOLMGREN ear specula.....	400		
retractor ROSE.....	140	RICHTER-HEATH clip forceps.....	224		
retractor ROSS.....	148/1	RIENHOFF-FINOCHIETTO rib spreader.....	486		
retractor ROUX.....	139	RIGBY abdominal retractor.....	189/2		
retractor ROUX-BABY.....	140	RI-MINI Diagnostic set.....	17		
retractor ROUX-MINI.....	140	RING tongue depressors.....	455		
retractor SAUERBRUCH.....	164	rings ligature.....	568		
retractor SAUERBRUCH.....	164, 166	RITTER-HALLE irrigation cannula.....	433		
retractor SENN-GREEN.....	153	ROBB spatula.....	530		
retractor SENN-MILLER.....	143	ROBERTS hemostatic clamp.....	117		
retractor SIMON.....	164	ROCHARD abdominal retractors.....	186		
retractor SPINA-NASALIS.....	461	ROCHESTER-CarmALT hemostatic clamp.....	109		
retractor TEBBETS.....	197	ROCHESTER-OCHSNER hemostatic clamp.....	108		
retractor TESSIER.....	463/3	ROCHESTER-PEAN hemostatic clamp.....	108		
retractor TUFFIER.....	147	ROEDER towel clamp.....	132		
retractor US-army PARKER-LANGENBECK.....	141	ROGER septum.....	437		
retractor VOLKMANN.....	153	ROGERS hysterectomy clamp.....	127		
retractor VOLKMANN.....	156	ROGGE sterilization forceps.....	227		
retractor YANCOSKIE.....	198	ROLLET EXTIRPATION chisels.....	374		
retractor ZENKER.....	161	ROLLET extraction hook.....	375		
retractors ADSON.....	173	rongeur CITELLI.....	430		
retractors ADSON.....	172, 173, 174	rongeur DECKER.....	341		
retractors ANDERSON-ADSON.....	172	rongeur FERRIS-SMITH-KERRISON.....	344, 344/2		

S

SAALFELD comedone extractor.....	608
SACHS dura dissector.....	332
SACHS nerve hook.....	328
SAENGER ovum forceps.....	606
sagittal split retractor SMITH.....	463/5
SaipingographSCHULTZE.....	596
SANVENERO surgical scissors.....	54/1
SAROT hemostatic clamp.....	118
SAROT needle holder.....	211
SATINSKY tangential clamp.....	502
SATINSKY vascular clamp.....	491
SATINSKY vascular scissors.....	65/1
SATTERLEE amputation saw.....	296
SAUERBRUCH bone rongeur.....	240
SAUERBRUCH retractor.....	164
SAUERBRUCH retractor.....	164, 166
SAUERBRUCH rib scissors.....	481
SAUERBRUCH wasteforceps.....	227
SAUERBRUCH-FREY sternum scissors.....	481
saw GIGLI.....	332
SAWLETT tonsil forceps.....	467
SAWYER rectal specula.....	560
SAYRE elevator.....	281
SCAGLIETTI bone rongeur.....	240
scalp forceps GAUSS.....	605
SCALP-CONTOUR retractors.....	169
scalpel.....	46
scalpel blade.....	42
scalpel blade remover.....	42
scalpel handle.....	38, 39, 39/1, 39/2, 40, 42
scalpel handle COLLIN.....	40
scalpel handle MINI.....	41
scalpel MINI.....	41
SCHAEDEL towel clamp.....	132
SCHAMBERG comedone extractor.....	608
SCHAEDE bone currettes.....	251
SCHAEIE goniotomy knives.....	373
SCHHEINMANN interchangeable tips.....	472
SCHERBAK vaginal specula.....	575
SCHINK dermatome.....	49
SCHIOETZ tonometer.....	394/2
SCHLESINGER laminectomy retractor forceps.....	342
SCHMEDEN nose forceps.....	427
Schmid vascular-irrigation cannula.....	338
SCHMIEDEN guideprobes.....	221



SCHMIEDEN-DICK ligaturee needle.....	219, 221	septum chisels FREER.....	439	skin hook FREER.....	448
SCHMIEDEN-TAYLOR durascissors.....	65/1	septum chisels SHEEHAN.....	441	skin hook GILLIES.....	448
SCHNIDT tonsil forceps.....	467	septum chisels SILVER.....	442	skin hook GRAEFE.....	148/2
SCHOENBORN thyroid gland hook.....	479	septum elevator BALLENGER.....	439	skin hook GUTHRIE.....	148/2
SCHRÖDER hook forceps.....	583, 584	septum elevator COTTLE.....	439	skin hook JOSEPH.....	149
SCHRÖDER uterine curette.....	595	septum elevator COTTLE-JOSEPH.....	439	skin hook KILNER.....	608
SCHROEDER(POZZI) hook forceps.....	582	septum elevator FREER.....	437	skin hook KLEINERT-KUTZ.....	149
SCHUBERT biopsy forceps.....	588	septum elevator HAJEK-BALLENGER.....	439	skin hook REDA.....	150
SCHUKNECHT knives.....	418	septum elevator HALLE.....	437	skin punch KEYE.....	608
SCHULTZE salpingrograph.....	596	septum elevator HOWARTH.....	438	skin punch KEYE.....	608
SCHULZE-BERGMANN rectal-specula.....	560	septum elevator JOSEPH.....	437	skin scissors.....	610
SCHUMACHER biopsy forceps.....	588, 589	septum elevator KILLIAN.....	438	skin STRAIGHTENING blade FOR DERMATOME.....	49
SCHUMACHER episotomy scissors.....	64	septum elevator MASING.....	437	slip joint plier.....	317
SCHUMACHER interchangeable tips.....	472	septum elevator MCKENTY.....	437, 438	SLS clip forceps.....	524
SCHUMACHER sternum scissors.....	481	septum elevator PENNINGTON.....	438	SLUDER-BALLENGER.....	470
SCHWEIGGER capsular forceps.....	391	septum elevator PIERCE.....	438	SMELLIE hook.....	605
scissors CASTROVIEJO.....	79	septum elevator ROGER.....	437	SMELLIE perforators.....	607
scissors CASTROVIEJO.....	79	septum forceps BRUENINGS.....	425	SMILLIE bone levers.....	291
scissors COTTLE.....	56	septum forceps HEYMANN.....	425	SMILLIE meniscusknives.....	292
scissors DOYEN.....	63	septum forceps KNIGHT.....	425	SMITH eye specula.....	370
scissors enterotomy.....	66	septum forceps LUC.....	426	SMITH ramus separator.....	463
scissors ENUCLEATION.....	58	septum forceps MIDDLETON-JANSEN.....	430	SMITH sagittal split retractor.....	463/5
scissors GORNEY.....	73	septum forceps RUBIN.....	428	SMITH US army bandage scissors.....	69/1
scissors GRAEFE.....	56	septum gouges FREER.....	442/1	SMITH-BUIE ANAL retractor.....	561
scissors HEPP-SCHEIDEL.....	78	septum gouges HAJEK.....	442/1	SMITH-PETERSEN.....	261
scissors MARTIN CARTILAGE.....	65/1	septum gouges KILLIAN-CLAUS.....	442/1	SMITH-PETERSEN bone rongeur.....	238
scissors McINDOE.....	65/1	septum knives CONVERSE.....	435	SMITHWICK applicator forceps.....	326
scissors micro.....	76	septum knives COTTLE.....	435	SMITHWICK nerve hook.....	328
scissors neurosurgical.....	65	septum knives FREER.....	434	SNELLEN cataract loop.....	378
scissors Parametrium.....	63	septum knives JOSEPH.....	434, 435	SNELLEN Entropium forceps.....	393
scissors REES.....	73	septum scissors KILLIAN.....	471	SOMER uterine-grasping forceps.....	585
scissors SIEBOLD.....	62	septum straightening forceps ASCH.....	449	spare blade.....	49
scissors SIMS.....	62	septum straightening forceps WALSHAM.....	449	spatula.....	203, 530/1, 612
scissors THOREK.....	65/2	SERPENTINE biopsy forceps.....	593	SPATULA AND PACKER.....	612
scissors WAGNER.....	67	SEUTIN bandage scissors.....	69/2	spatula Hirschman.....	379
scissors WERTHEIM.....	63	SEXTON ear knives.....	408	specula FRIEDMANN.....	577
sclerotome GUYTON-LUNDSGAARD.....	373	SHAPLEIGH ear loop.....	410	specula KALLMORGEN.....	573
sclerotome LUNDGAARD.....	373	SHAVER knives.....	49	specula KRISTELLER.....	572
SCOVILLE bone curette.....	253	SHEA micro ear scissors.....	413	specula O'SULLIVAN-O'CONNOR.....	576
SCOVILLE hook.....	196	SHEEHAN chisels.....	441	SPENCER suture scissors.....	66
SCOVILLE laminectomy retractor.....	196	SHEETS eye cannula.....	394/2	SPENCER-WELLS hemostatic clamp.....	109
SCOVILLE nerve hook.....	329, 330	sickle knives REDA.....	435	Sphygmomanometer BABYPHON.....	10
SCOVILLE-HAVERFIELD laminectomy retractor.....	196	SIEBOLD gynecological scissors.....	62	Sphygmomanometer DIPLOMAT.....	5
screw driver.....	232	SIEGLE ear specula.....	402	Sphygmomanometer EXACTA.....	8
screw driver LANE.....	323	Silver clips.....	326	Sphygmomanometer MINIMUS.....	11, 12
screw driver WILLIAMS.....	323	SILVER DERMATOM.....	50	Sphygmomanometer NOVA.....	6, 7
screw holding sleeve.....	324	SILVER septum chisels.....	442	Sphygmomanometer PRECISA.....	9
SCUDDER intestinal clamp.....	541	SIMCOE irrigation cannula.....	394/2	SPINAL bone currettes.....	253
SEBILÉAU elevator.....	275	SIMON retractor.....	164	Spinal hook TAYLOR.....	291
Section needle.....	268	SIMON uterine curette.....	594	SPINA-NASALIS retractor.....	461
SEDLLOT raspatories.....	274	SIMPLEX tubing clamp.....	624	splinterforceps ARCHER.....	92
SEGMENTED RING.....	194	SIMPSON obstetrical forceps.....	602	splinterforceps PEET.....	92
SEGOND hysterectomy clamp.....	125	SIMPSON-BRAUN obstetrical forceps.....	602	splinterforceps VIRTUS (RALK).....	92
SEGOND myoma knives.....	594	SIMPSON-LUIKART obstetrical forceps.....	603	splinterforcepsSTIEGLITZ.....	92
SEGOND-LANDAU hysterectomy clamp.....	125	SIMS gynecological scissors.....	62	splinterforceps forceps.....	91
SEIFERT interchangeable tips.....	472	SIMS rectal-specula.....	559	splinterforceps forceps CARMALT.....	91
SELDIN raspatory.....	277	SIMS uterine curette.....	597	splinterforceps forceps FEILCHENFELD.....	91
SELLHEIM obstetrical curette.....	607	SIMS uterine depressor.....	586	splinterforceps forceps HUNTER.....	91
SELLORS rib contractor.....	489/1	SIMS uterine dilator.....	581	spoon medicine.....	621
SEMB bone cutting forceps.....	242	SIMS uterine probes.....	586	SPRATT bone currettes.....	251
SEMB bone holding forceps.....	243	SIMS vaginal specula.....	573	spreader DAVIS-BOYLE.....	455
SEMB bone rongeur.....	240	SIMS-MAIER dressing forceps.....	134	spreader DAVIS-MEYER.....	457
SEMB bronchusclamp.....	491	SINGLEY tissue forceps.....	88	spreader DINGMANN.....	456
SEMB raspatories.....	278	Simskey hook.....	376	spreader KILNER-DOUGHTY.....	456
SEMKEN anatomic tissue forceps.....	86	Sinus probes.....	438	SPURLING laminectomy retractor forceps.....	340
SEMKEN surgical tissue forceps.....	86	SINUS septum elevator.....	438	sputum cup.....	621/1
SEMM vaginal specula.....	571	sinuscopy forceps.....	431	srewholding forceps LANE.....	325
SENN-GREEN retractor.....	153	sinuscopy-trocar.....	205	ST.CLAIR-THOMSON adenoid curette.....	450
SENN-MILLER retractor.....	143	SKENE hook forceps.....	582	ST.MARKS pelvis hook.....	165
septum cannula.....	406	skin hook COTTLE.....	447, 448	ST.MARTIN tissue forceps.....	392
septum chisels CINELLI.....	441	skin hook COTTLE-NEIVERT.....	448	STACKE earprobes.....	199
septum chisels COTTLE.....	440	skin hook FOMON.....	447/1	STAMMBERGER forceps.....	431
septum chisels FOMON.....	441	skin hook FRAZIER.....	148/2	STAUDE-MOORE hook forceps.....	582

STEINMANN ENDER nail .....	307, 308	suction tube DEBAKEY .....	28	TC scissors PECK-JOSEPH .....	74
STEINMANN tendon holdingforceps .....	292	suction tube FRAZIER/FERGUSSON .....	337	TC scissors REES .....	73
STELLBRINK bone rongeur .....	234	suction tube HOUSE .....	337/2	TC surgical scissors STANDARD .....	51
STERILE scalpel-blade .....	42	suction tube PLESTER .....	338	TC tissue forceps CUSHING .....	83
STERILE spare blade .....	50	suction tube POOLE .....	27	TC tissue forceps GILLIES .....	86
sterilization clamp BUNT .....	227	suction tube ROSEN .....	338	TC tissue forceps SEMKEN .....	86
sterilization clamp MAYO .....	227	suction tube tube KLEINSASSER .....	36	TC tissue forceps surgical .....	81
sterilization forceps .....	227	suction tube YANKAUER .....	27	TC tissue forceps WANGENSTEEN .....	89
sterilization forceps .....	227	suction tube YASARGIL .....	337/1	TC tissue forcepsN ANATOMIC .....	81
sterilization forceps CHEATLE .....	227	suction tube ZOEGLNER .....	337/1	TC-scissors Gorney .....	73
sterilization forceps REDA .....	615	supercut scissors .....	71	TC-scissors KAYE .....	73
sterilization forceps ROGGE .....	227	supercut scissors BABY METZENBAUM .....	71	TEALE hook forceps .....	583
sterilization forceps UNIVERSAL .....	227	supercut scissors FREEMAN .....	74	TEBBETTS retractor .....	197
sterilization tray .....	622, 623	supercut scissors GORNEY .....	73	teeth tissue forceps LONDON-COLLEGE .....	93
sterilization tray .....	618	supercut scissors IRIS .....	72	teeth tissue forceps MERIAM .....	93
STERNBERG cheek retractor .....	453	supercut scissors KAYE .....	73	tenaculum forceps ADAIR .....	582
sternum scissors SCHUMACHER .....	481	supercut scissors KILNER/RAGNELL .....	72	tenaculum forceps POZZI-PALMER .....	582
Sternumchisels LEBSCHKE .....	267	supercut scissors LAGRANGE .....	72	tendon grasping forceps .....	293
stethoscope ANESTOPHON .....	23	supercut scissors LISTER .....	72	tendon grasping forceps JACKSON .....	292
stethoscope DUPLEX .....	23	supercut scissors MAYO .....	71	tendon grasping forceps LARSEN .....	292
stethoscope PINARD .....	23	supercut scissors MAYO-STILLE .....	71	tendon grasping instr KLEINERT-KUTZ .....	294
STEVENS iris tissue forceps .....	383	supercut scissors METZENBAUM .....	71	tendon grasping instrument BRAND .....	293
STEVENS lens hook .....	375	supercut scissors REES .....	73	tendon grasping instrument CAROLL .....	293
STEVENS needle holder .....	214	supercut scissors REYNOLDS .....	72	tendon guide BUNELL .....	294
STEVENS ophthalmologic scissors .....	58	supercut scissors STEVENS .....	72	tendon holding forceps STEINMANN .....	292
STEVENS supercut scissors .....	72	supercut scissors WAGNER .....	72	tendon passing instr. BRAND .....	294
STEVENSON eye specula .....	371	surgical needle KEITH .....	223	tendon passing instr. BUNNELL .....	292
STIEGLITZ splinter forceps .....	92	surgical needle KOENIG .....	223	TERSON capsular forceps .....	391
STILLE anatomic tissue forceps .....	81	surgical scissors FERGIUSSON .....	66	TESSIER retractor .....	463/3
STILLE bone hand drills .....	298	surgical scissors fine IRIS .....	54/2	T-handle .....	300, 301
STILLE chisels .....	260	surgical scissors fine JOSEPH .....	54/1	T-handle HUDSON .....	300
STILLE chisels .....	260	surgical scissors fine KILNER .....	54/1	THIERRY obstetrical forceps .....	603
STILLE gouges .....	260	surgical scissors fine REYNOLDS .....	54/1	THOMAS uterine curette .....	599
STILLE hemostatic clamp .....	122	surgical scissors fine SANVENERO .....	54/1	THOMAS-GAYLOR biopsy forceps .....	588
STILLE plaster scissors .....	229	surgical scissors METZENBAUM .....	51, 54/1	THOMAS-ALLIS intestinal grasping forceps .....	538
STILLE rib scissors .....	480	surgical scissors STANDARD .....	51	THOMSON-WALKER bladder retractors .....	552
STILLE-LISTON bone cutting forceps .....	241	surgical scissors SYSTRUNK .....	66	thoracic spreader MERCEDES .....	489
STILLE-LUER bone rongeur .....	239	surgical tissue forceps .....	81	THOREK scissors .....	65/2
STILLE-RUSKIN bone rongeur .....	239	surgical tissue forceps ADSON .....	81/2	THUDICHUM nose specula .....	421
STILLE-SHERMAN bone hand drills .....	298	surgical tissue forceps ADSON Micro .....	81/2	thyroid gland hook SCHOENBORN .....	479
STOCKMANN penis clamp .....	553/1	surgical tissue forceps ADSON-BROWN .....	82	TIECK-HALLE nose specula .....	423
stomach clamp LANE .....	547	surgical tissue forceps BONNEY .....	88	TILLEY ear forceps .....	411
stomach-/intestinal suturing apparatus V.PETZ .....	549	surgical tissue forceps BROPHY .....	84	TIP for suction tube .....	27
stomach-intestinal clamp MIKULICZ .....	543	surgical tissue forceps CUSHING .....	83	TISCHLER-DOWN biopsy forceps .....	591
STONE forceps .....	545	surgical tissue forceps FERRIS-SMITH .....	85	TISCHLER-KEVORKIAN biopsy forceps .....	592
Stone holding clamp .....	545	surgical tissue forceps GERALD .....	87	TISCHLER-MORGAN biopsy forceps .....	591
STONE-WATT .....	545	surgical tissue forceps GILLIES .....	86	TISCHLER-MORGAN biopsy forceps .....	590, 591
strabismus forceps BONACCOLTO .....	385	surgical tissue forceps LANE .....	84	TISCHLER-UP biopsy forceps .....	591
strabismus forceps DASTOOR .....	386	surgical tissue forceps OEHLER TC .....	81/1	tissue forceps .....	90, 94
strabismus forceps JAMESON .....	385	surgical tissue forceps Potts Smith .....	81	tissue forceps anatomic .....	81
strabismus forceps McCULLOUGH .....	385	surgical tissue forceps SEMKEN .....	86	tissue forceps bipolar .....	630, 631
strabismus hook GRAEFE .....	375	surgical tissue forceps STILLE .....	81	tissue forceps BONNEY .....	88
strabismus hook JAMESON .....	375	surgical tissue forceps TAYLOR .....	87	tissue forceps BROWN .....	83
STRANDELL-STILLE retractor .....	157	surgical tissue forceps type USA .....	81/1	tissue forceps CASTROVIEJO .....	392
STRASSBURGER tissue forceps .....	89	surgical tissue forceps WAUGH .....	83	tissue forceps DAVIS .....	227
STRATTE needle holder .....	212	suture fork REDA .....	221/1	tissue forceps DeBakey .....	99
STRAUSS penis clamp .....	553/1	suture scissors HEATH .....	66	tissue forceps Gerald .....	86, 87
Stripper .....	202	suture scissors LITTAUER .....	66	tissue forceps GOMEL .....	96
STRULLY neuro surgical .....	65	suture scissors NORTHBENT .....	66	tissue forceps GRAEFE .....	83
STRUYCKEN nose forceps .....	427	suture scissors SPENCER .....	66	tissue forceps jewelry .....	90
SUBRAMANIAN-MINIATURE .....	521	SWEET applicator forceps .....	326	tissue forceps MAYO .....	89
suction -irrigation cannula .....	394	SYSTRUNK surgical scissors .....	66	tissue forceps McPHERSON .....	392
suction handle WULLSTEIN .....	338	T		tissue forceps MOORFIELD .....	392
suction raspatories GUILLEN .....	433/1	TABB knives .....	418	tissue forceps PAUFIQUE .....	392
suction tube ADSON .....	337	TAKAHASHI nose forceps .....	427	tissue forceps SINGLEY .....	88
suction tube ANDREW-PYNCHON .....	28	Tangentialclamp DeBAKEY-SATINSKY .....	502	tissue forceps STRASSBURGER MODELL .....	89
suction tube BARON .....	336	TARNIER cranioplast .....	607	tissue forceps type TUEBINGEN .....	392
suction tube COOLEY .....	28	TARNIER obstetrical forceps .....	604	tissue forceps ULTRA LIGHT .....	95
suction tube DASTOOR .....	380	TAYLOR percussion mallet .....	24	tissue forceps WAGENSTEEN .....	89
		TAYLOR SPINAL hook .....	291	tissue forceps YASARGIL .....	97
		TAYLOR surgical tissue forceps .....	87	tissue forcepsSt. MARTIN .....	392
		TC scissors FREEMAN .....	74	tissue grasping forceps CHAPUT .....	110
				tissue grasping forceps COLLIN .....	110

tissue grasping forceps TUFFIER .....	110	towel clamp BACKHAUS-clip .....	132	U	
titanium clips .....	549	towel clamp BALL AND SOCKET .....	133	UCKERMANN cotton-applicator.....	203
titanium HALSTED-MOSQUITO hemostatic clamp .....	105	towel clamp BERNHARD .....	133	ULRICH bone holding forceps .....	248
titanium hemostatic clamp CRILE .....	107	towel clamp DOYEN.....	133	ULRICH dressing forceps.....	135
titanium hemostatic clamp KELLY .....	106	towel clamp JONES .....	132	Ultra-Light-tissue forceps atrauma .....	95
titanium tissue forceps DEBAKEY .....	99	towel clamp JONES-clip .....	132	umbilical cord COLLIN .....	605
titanium-ATRAUMA-bulldog clamp .....	102	towel clamp LANE .....	133	umbilical cord KANE .....	605
TOBOLD cotton-applicator .....	203	towel clamp LORNA.....	133	umbilical cord scissors BRAUN-STADLER .....	64
TOBOLD tongue depressors.....	453	towel clamp MOYNIHAN .....	133	umbilical cord scissors BUSCH .....	64
TOENNIS dura dissector .....	332	towel clamp PEERS .....	132	umbilical cord scissors SCHUMACHER .....	64
TOENNIS hemostatic clamp .....	117	towel clamp ROEDER .....	132	umbilical cord scissors type USA .....	64
TOENNIS-ADSON dissecting scissors .....	65	towel clamp SCHAEDEL .....	132	UNI I DIAGNOSTIK-BES.....	13
TOHUKU towel clamp .....	132	towel clamp TOHOKU .....	132	UNI III DIAGNOSTIK-BES.....	15
tongue blade DOUGHTY .....	458	TOWNLEY caliper.....	26	UNIVERSAL bandage scissors .....	70
tongue depressors .....	451	TOWNSEND biopsy forceps .....	591	UNIVERSAL endoscope assembly .....	188
tongue depressors ANDREW .....	452	TOWNSEND MINI biopsy forceps.....	591	Universal handle HUBER .....	472
tongue depressors BRUENINGS .....	451	TOWNSEND TISCHLER MINI biopsy forceps .....	591	UNIVERSAL sterilization forceps.....	227
tongue depressors BUCHWALD .....	451	TOYNBEE ear specula .....	399	Universal tray .....	620
tongue depressors DAVIS-BOYLE .....	455	trachea cannula LUER.....	479	UNIVERSAL trocar.....	204
tongue depressors DINGMANN .....	456	trachea cannula WAGENER-MOSHER .....	477	UNIVERSAL wire scissors .....	67
tongue depressors FRENZEL .....	451	trachea cannulaCHEVALIER-JACK .....	479	UNNA comedone extractor .....	608
tongue depressors HARTMANN .....	452	trachea dilator LABORDE .....	476	Urethrotome OTIS .....	553
tongue depressors KILNER-DOUGHTY .....	456	trachea dilator TROUSSEAU.....	476	US army retractor .....	141
tongue depressors KROENIG .....	451	trachea dilator TROUSSEAU-BABY .....	476	USA anatomic tissue forceps.....	81
tongue depressors MAYO .....	451	trachea hook BOSE .....	476, 477	USA type umbilical cord scissors .....	64
tongue depressors MORITZ-SCHMIDT .....	452	trachea hook ITERSON .....	477	uterine clamp GREEN-ARMYTAGE .....	605
tongue depressors RING .....	455	trachea hook JACKSON.....	476	uterine curette SIMON .....	594
tongue depressors RUSSEL-DAVIS.....	458	trachea hook NEWS .....	477	uterine curette BLAKE.....	595
tongue depressors TOBOLD .....	453	Trachoma forceps KNAPP-LUER .....	393	uterine curette BUMM.....	597
tongue depressors WIEDER .....	452	Transformer .....	22	uterine curette GOURDET .....	599
tongue forceps COLLIN .....	453	TRANSFORMER FOR laryngoscope handle.....	34	uterine curette RECAMIER .....	597
tongue forceps YOUNG .....	453	TRAVERS retractors .....	172	uterine curette SCHRÖDER .....	595
tonometer SCHIOETZ .....	394/2	tray .....	619	uterine curette SIMS .....	597
tonsil forceps Abraham .....	468	Tray universal.....	620	uterine curette THOMAS .....	599
tonsil elevator HENKE .....	465	TRELAT tonsil needle .....	466	uterine depressor BRAUN.....	586
tonsil elevator HURD .....	465	TRELAT vaginal specula .....	571	uterine depressor SIMS .....	586
tonsil elevator LOPEZ-REINKE .....	465	trocar COAKLEY .....	204	uterine Dilatator GOODELL .....	581
tonsil elevator YANKAUER.....	465	trocar DOUGLAS .....	204	uterine Dilatator HANK .....	580
tonsil forceps BALLENGER .....	467	trocar LICHTWITZ .....	204	uterine Dilatator HEGAR .....	578, 579
tonsil forceps BLOHMKE .....	467	trocar NELSON .....	205	uterine Dilatator PRATT .....	580
tonsil forceps MARSCHIK .....	468	trocar OCHSNER .....	205	uterine Dilatator SIMS .....	581
tonsil forceps NEGUS .....	467	trocar PIERCE .....	204	uterine Dilatator WYLIE .....	581
tonsil forceps SAWTELL .....	467	trocar UNIVERSAL .....	204	uterine grasping forceps COLLIN .....	585
tonsil forceps SCHNIDT .....	467	trocarStandard (NELSON) .....	204	uterine grasping forceps DARTIGUES .....	585
tonsil forceps TYDING .....	467	TROELTSCH ear forceps .....	424	uterine grasping forceps SOMER .....	585
tonsil forceps WHITE .....	467	TROEMNER percussion mallet .....	24	uterine polyp forceps DOYEN .....	585
tonsil grasping forceps COLVER.....	467	TROUSSEAU trachea dilator .....	476	uterine polyp forceps KELLY .....	585
tonsil knives ABRAHAM .....	466	TROUSSEAU-BABY trachea dilator .....	476	uterine polyp forceps NOTO .....	585
tonsil knives BRUENINGS.....	466	TROUTMAN iris tissue forceps .....	389	uterine-probes COLLIN .....	586
tonsil knives CANFIELD .....	466	TROUTMAN iris tissue forceps .....	384, 389	uterine-probes MARTIN .....	586
tonsil knives CARPENTER .....	465	TROUTMAN-CHRIS bladeBREAKERS .....	45	uterine-probes SIMS .....	586
tonsil knives DOUGLAS .....	466	tubal catheter .....	596		
tonsil knives FISHER .....	466	tube milking roller .....	131	V	
tonsil needle .....	470	tubing clamp .....	129	vaginal specula .....	569
tonsil needle CLAUS .....	466	tubing clamp HOFFMANN .....	624	vaginal specula JACKSON .....	573
tonsil needle DUPUY-WEISS .....	466	tubing clamp SIMPLEX .....	624	vaginal specula AUVARD .....	576
tonsil needle NAGER .....	466	tubing clampBülow-Gunar-Hey .....	130	vaginal specula BREISKY .....	577
tonsil needleTRELAT .....	466	TÜBINGEN IRIS forceps.....	387	vaginal specula COLLIN .....	570
tonsil scissors.....	59	TÜBINGEN tissue forceps.....	392	vaginal specula CUSCO .....	570
tonsil scissors BOETTCHER .....	59	TUFFIER retractor .....	147	vaginal specula DOYEN .....	574
tonsil scissors DEAN .....	59	TUFFIER rib spreader .....	487	vaginal specula GRAVE.....	570
tonsil scissors GOOD .....	59	TUFFIER tissue grasping forceps .....	110	vaginal specula KRISTELLER.....	572
tonsil scissors PRINCE.....	59	Tumor grasping forceps LANDOLT .....	341/2	vaginal specula LANDAU .....	577
tonsil snare BRUENINGS .....	468	Tumortissue forceps YASARGIL .....	97	vaginal specula PEDERSON .....	570
tonsil snare EVES .....	468	tuning forc .....	404	vaginal specula SCHERBAK .....	575
tonsil syringe .....	470	tuning forc HARTMANN .....	403	vaginal specula SEMM .....	571
tonsil wire .....	468	tuning forc LUCAE.....	404	vaginal specula SIMS .....	573
tonsilotome SLUDER-BALLENGER .....	470	tuning forc REDA.....	403	vaginal specula TRELAT .....	571
tonsilotome TYDING.....	469	tuning forc RYDEL-SEIFFERT .....	404	vaginal specula VU-MORE.....	569
TOOK corneal scarifier .....	373	TURNBULL nail forceps .....	609	VALLEIX probes .....	586
Tourniquet RUMEL-BELMONT .....	528	TURREL rectal biopsy forceps .....	567	VAN BUREN bone holding forceps .....	249
towel clamp .....	133	TYDING tonsil forceps .....	467	VAN BUREN dilation bougie .....	554
towel clamp BACKHAUS .....	132	TYDING tonsilotome.....	469	VAN DOREN biopsy forceps .....	588



VANNAS eye scissors .....	79	WEBER aorta clamp.....	501	YASARGIL aneurysm .....	349 - 356
VARADY varix instrument.....	202	WEBER cataract loop .....	378	YASARGIL GALEAhook.....	330
varicose vein probes NABATOFF .....	201	WEBSTER needle holder.....	208	YASARGIL suction tube .....	337/1
varix instrument VARADY .....	202	WECKER eye scissors .....	75	YASARGIL tumor tissue forceps.....	97
vascular clamp BAINBRIDGE .....	495/1, 495/2	WECKER iris spatula.....	378	YEOMAN rectal biopsy forceps .....	566, 567
vascular clamp COOLEY .....	518, 522	WEEK eye specula .....	370	YOUNG BOOMERANG .....	220
vascular clamp DALE .....	494, 495	WEIL-BLAKESLEY nose forceps .....	426	YOUNG prostatic hook .....	550
vascular clamp DARDIK.....	509/1	WEITLANER retractors.....	169	YOUNG tongue forceps .....	453
vascular clamp DEBAKEY .....	493-500, 502, 505-508, 512-517	WEITLANER-WULLSTEIN retractors.....	169		
vascular clamp DEBAKEY children .....	516	WELLER dissecting scissors .....	53/2	<b>Z</b>	
vascular clamp DEBAKEY-MIXTER.....	499/2	WELLS enucleation curette.....	378	ZAUFAL ear lever .....	409
vascular clamp DEBAKEY-RUMEL .....	499	WERTHEIM gynecological scissors .....	63	ZAUFAL-JANSEN bone rongeur .....	238
vascular clamp DIEFFENBACH.....	104	WERTHEIM hysterectomy clamp .....	124, 128	ZAUFAL-JANSEN ear lever .....	409
vascular clamp GLOVER .....	515	WERTHEIM hysterectomy scissors.....	63	ZENKER hemostatic clamp.....	118
vascular clamp SATINSKY .....	491	WERTHEIM-CULLEN hysterectomy clamp.....	125	ZENKER retractor .....	161
vascular clip BIEMER .....	361	WEST nose chisels .....	442	ZIEGLER discision knives .....	373
vascular clip MEHDORN .....	362	WESTCOTT eye scissors .....	75	ZIEGLER eye specula .....	371
vascular clip MUELLER.....	365	WESTMACOTT nose dressing forceps .....	424	ZIEGLER head mirror .....	21
vascular scissors DE BAKY .....	61	WESTON rectalsnare.....	566	ZIEGLER iris knives .....	372
vascular scissors DeBakey TC.....	60	WHEELER cyclodialysis spatula .....	379	ZIEGLER lachrymal dilator .....	381
vascular scissors DIETRICH.....	60	WHEELER discision knives .....	373	ZIELKE gouges.....	264
vascular scissors FAVALORO.....	61	WHITE tonsil forceps.....	467	ZOELLNER suction tube.....	337/1
vascular scissors KELLY .....	61	WIBERG raspatoriesIUM.....	277		
vascular scissors KLINKENBERG-LOTH.....	65/2	width ruler .....	594		
vascular scissors POTTS-DE MARTEL .....	59	WIEDER tongue depressors.....	452		
vascular scissors POTTS-SMITH.....	61	WIENER antrum rasp .....	443		
vascular scissors SATINSKY .....	65/1	WIENER iris hook .....	375		
vascular tissue forceps ADLERKREUTZ .....	84	WIGMORE plaster knives.....	229		
vascular tissue forceps NELSON .....	89	WIKSTROEM hemostatic clamp .....	117		
vascular tissue forcepsSTILLE-BARRAYA .....	88	WILDE polyp snare.....	411		
vascular-cannula SCHMID .....	338	WILDE polyp snare.....	433/2		
vascular-dilator DEBAKEY .....	529	WILDE(TROELTSCH) ear forceps.....	410		
vasculardissector ROBB .....	530	WILDER cataract loop .....	378		
vasectomy clamp .....	553/2	WILDER dilator .....	381		
VERBRUGGE bone holding forceps .....	245	WILLET MARTEL grasping forceps.....	110		
VERBRUGGE-MÜLLER bone levers .....	287	WILLIAMS eye specula .....	370		
VERESS insufflation cannula.....	206	WILLIAMS intestinal grasping forceps.....	539		
VIENNA guide probes .....	221/1	WILLIAMS screw driver .....	323		
VIENNA nose specula .....	421	WILLIGER curette.....	255, 257		
VIRCHOW POST MORTEM knives .....	48	WILLIGER mallet .....	271		
VIRTUS(RALK) splinter forceps .....	92	WILLIGER raspatories .....	276		
VOLKMANN bone curettes .....	251	WINTER ovum forceps .....	606		
VOLKMANN curette .....	257	wire basket for endoscope .....	623		
VOLKMANN retractor .....	153	wire cutter HERCULES.....	320/1 - 320/3		
VOLKMANN retractor.....	153, 156	wire dispenser .....	310		
VOLTOLINI nose specula .....	421	wire forceps .....	317 - 320/3		
VU-MORE vaginal specula.....	569	wire forceps BERRY TC .....	319		
		wire forceps CORWIN-HEGAR TC.....	319		
<b>W</b>		wire forceps MAYO-HABERISSER TC.....	319		
WACHENFELDT clip tissue forceps.....	224	wire gauze .....	311		
WADSWORTH-TODD .....	378	wire grasping forceps .....	318		
WAGENER-MOSHER trachea cannula .....	477	wire guide needle DEMEL .....	315		
WAGENR hook .....	409	wire instrument DEMEL.....	315		
WAGNER laminectomy retractor forceps.....	343	wire instrument LOUTE .....	315		
Wagner scissors .....	67	wiresaw OLIVECRONA .....	332		
WAGNER supercut scissors .....	72	wirescissors UNIVERSAL .....	67		
WALDMANN episotomy scissors.....	64	WITTNER biopsy forceps .....	589		
WALLICH ovum curette.....	607	WOLFF plaster forceps .....	233		
WALSHAM septum straightening forceps .....	449	WOODSON dura dissector .....	333		
WALTHER catheter .....	555	WORST probes .....	333		
WALTON foreign body gouges .....	374	wound curette ARRUGA .....	378		
WALTON comedone extractor .....	608	WRIGLEY obstetrical forceps.....	602		
WALTON Finger ring saw .....	297	WULLSTEIN knives .....	418		
WANGENSTEIN vascular tissue forceps .....	89	WULLSTEIN micro-curette forceps.....	416		
WARTENBERG PINWHEEL .....	25	WULLSTEIN retractors .....	171		
waste forceps SAUERBRUCH .....	227	WULLSTEIN suction handle .....	338		
water jet pistol.....	626	WYLIE aortic clamp .....	501/1, 501/2		
WATSON DERMATOM .....	50	WYLIE uterine dilator.....	581		
WATSON-CHEYNE .....	283				
WATSON-CHEYNE probes .....	199	<b>Y</b>			
WATSON-WILLIAMS nose forceps .....	428	YANCOSKIE retractor.....	198		
WAUGH surgical tissue forceps .....	83	YANKAUER suction tube .....	27		
		YANKAUER tonsil dissector .....	465		

Abraham bisturi para amígdalas.....	466	Air Injection canula.....	394	asa Langenbeck.....	409
Abraham pinza para coger amígdalas.....	468	alambre de Kirschner.....	306, 307	asa Shapleigh.....	410
abre-boca Davis-Boyle.....	455	alambre de Steinmann.....	307, 308	asa Snellen.....	378
abre-boca Davis-Meyer.....	457	alambres.....	306-308	asa Weber.....	378
abre-boca Denhart.....	454	Alan-Parks especulo rectal.....	561	asa Wilder.....	378
abre-boca Dingmann.....	456	Alderdyce elevador.....	282	Asch pinza para enderezar el tabique nasal.....	449
abre-boca Doughty-Kilner.....	456	Alexander cincel.....	259	Aufranc-Cobra separador.....	289
abre-boca Doyen-Jansen (Molt).....	454	Alexander gubia.....	259	Aufricht lima nasal.....	443
abre-boca Heister.....	454	Alexander periostotomo.....	276	Aufricht retractor nasal.....	447
abre-boca Jansen-Doyen (Molt).....	454	Alexander pinza para biopsia.....	589	Auard especulo vaginal.....	576
abre-boca Jennings.....	454	Alexander-Matson periostotomo.....	279	Axenfeld cucharilla para chalazion.....	377
abre-boca Kilner-Doughty.....	456	alicate corta-uñas.....	609, 612/2-614	Axenfeld-Mellinger biefarostato.....	370
abre-boca Koenig-Roser.....	454	alicate corta-uñas Anvil.....	613	Ayer pinza para ligadura.....	393
abre-boca Mclvor.....	457	alicate cuticular.....	613	B	
abre-boca Molt (Doyen-Jansen).....	454	alicate Grip.....	316	Babcock pinza intestinal.....	539
abre-boca Roser-Koenig.....	454	alicate para cortar uñas Turnbull.....	609	Babinsky martillo de percusion.....	24
aceite para instrumentos InstruCare.....	635	alicates.....	316-318, 320	Babinsky martillo de percusion.....	24
Adair pinza uterina.....	582	alicates para alambres.....	317-320/3	Baby Balfour separador abdominal.....	182, 183
Adams-Mayo separador.....	171	alicates para alambres Hercules.....	320/1-320/3	Baby Burke pinza para biopsia.....	590
adaptador para iluminacion para amnioscopio.....	600	alicates para cortar alambres.....	316-320	Baby Gosset separador abdominal.....	181
adenotomo LaForce.....	450	Allen pinza para apendice.....	544	Baby Lexer tijera de diseccion.....	53
Adlerkreutz pinza de diseccion.....	84	Allis pinza intestinal.....	537	Baby Metznerbaum tijera supercut.....	71
Adson Anderson separador.....	172	Allis-Adair pinza intestinal.....	537	Baby Mixer pinza hemostatica.....	119/1
Adson Baby pinza hemostatica.....	113	Allis-Baby pinza intestinal.....	537	Baby Roux separador.....	140
Adson elevador.....	282	Allis-Judd pinza intestinal.....	538	Baby-Bailey aproximador para costillas.....	489/1
Adson gancho para dura-madre.....	329	Allis-Lockwood pinza intestinal.....	538	Baby-Doyen pinza intestinal.....	540
Adson pinza de diseccion.....	81/2, 82	Allison espátula pulmonar.....	489/2	Baby-Kocher pinza intestinal.....	540
Adson pinza de proteccion.....	298	Allis-Thoms pinza intestinal.....	538	Baby-Olsen-Hegar porta aguja.....	212
Adson pinza gubia.....	236	Alm separador.....	168	Baby-Overholt pinza hemostatica.....	114
Adson pinza hemostatica.....	112, 113	Alvis cureta para cuerpos extraños.....	374	Baby-Payr pinza intestinal y estomacal.....	548
Adson pinza para hipofisis.....	334	amigdalotomo Sluder-Ballenger.....	470	Babyphon esfigmomanometro.....	10
Adson porta aguja.....	211	amigdalotomo Tyding.....	469	Baby-Tischler pinza para biopsia.....	592
Adson separador.....	172-174	amniotomo.....	586, 600	Baby-Trousseau dilatador traqueal.....	476
Adson tubo de aspiracion.....	337	amniotomo Beacham.....	586	Baby-Yankauer tubo de aspiracion.....	27
Adson-Beckmann separador.....	175	Amnsler-Connin marcador.....	380	Back holder separador abdominal.....	192-195
Adson-Brown pinza de diseccion.....	82	Anderson Adson separador.....	172	Backhaus pinza de campo.....	132
Adson-DeBakey pinza de diseccion.....	81/2	Anderson separador.....	198	Backhaus-Clip pinza de campo.....	132
Adson-Toennis tijera.....	65	Anderson-Neivert cincel nasal.....	442	Bahnson-DeBakey pinza para aneurisma.....	506
Aebli tijera corneal.....	58	Andrew baja-lengua.....	452	Bailey aproximador para costillas.....	489/1
agrafe Michel.....	224	Andrew-Pynchon tubo de aspiracion.....	28	Bailey-Baby aproximador para costillas.....	489/1
aguja Barbara.....	419	Anestophon estetoscopio.....	23	Bailey-Gibbon aproximador para costillas.....	489/1
aguja de discision Bowman.....	374	anillo para Kleinsasser.....	36	Bainbridge pinza hemostatica.....	119/2
aguja de guia para anestesia.....	206	anoscopio Chelsea-Eaton.....	563	Bainbridge pinza vascular de uso multiple.....	495/1-495/2
aguja de guia Redon.....	207	anoscopio Hirschmann.....	562	baja-lengua Andrew.....	452
aguja para amígdalas.....	470	anoscopio Ives-Fansler.....	562	baja-lengua Bruenings.....	451
aguja para autopsia.....	268	anteojos para nistagmo Frenzel.....	20	baja-lengua Buchwald.....	451
aguja para biopsia Menghini.....	206	Antrum cureta.....	435	baja-lengua Cawood-Minnesota.....	451
aguja para catarata.....	374	Anvil alicate corta-uñas.....	613	baja-lengua Davis-Russel.....	458
aguja para cuerpos extraños.....	374	aparato para suturar estomago y intestinos V. Petz.....	549	baja-lengua Doughty.....	458
aguja para cuerpos extraños Davis.....	374	aproximador de Biemer.....	366	baja-lengua Frenzel.....	451
aguja para cuerpos extraños Francis.....	374	aproximador de Biemer-Müller.....	363	baja-lengua Hartmann.....	452
aguja para cuerpos extraños Levinson.....	374	aproximador de Müller.....	364	baja-lengua Kroenig.....	451
aguja para laringe.....	470	aproximador de Müller-Biemer.....	363	baja-lengua Mayo.....	451
aguja para ligadura.....	218, 219	aproximador para costillas Baby-Bailey.....	489/1	baja-lengua Minnesota-Cawood.....	451
aguja para ligadura Cooper.....	219	aproximador para costillas Bailey.....	489/1	baja-lengua Moritz-Schmidt.....	452
aguja para ligadura Deschamps.....	218	aproximador para costillas Bailey-Baby.....	489/1	baja-lengua Ring.....	455
aguja para ligadura Dick-Schmieden.....	219	aproximador para costillas Bailey-Gibbon.....	489/1	baja-lengua Russel-Davis.....	458
aguja para ligadura Kronecker.....	219	aproximador para costillas Gibbon-Bailey.....	489/1	baja-lengua Schmidt-Moritz.....	452
aguja para ligadura Nelson.....	219	aproximador para costillas Sellors.....	489/1	baja-lengua Tobold.....	453
aguja para ligadura Schmieden-Dick.....	219	Archer pinza para espinas.....	92	baja-lengua Wieder.....	452
aguja para neumoperitoneo Verres.....	206	Arit asa.....	378	baja-lenguas.....	451-453, 455
aguja para paracentesis Lucae.....	408	Armytage-Green pinza para uterus.....	605	Bakes dilatador para conductos biliares.....	532
aguja para paracentesis Politzer.....	408	Arruga biefarostato.....	370	Balfour Baby separador abdominal.....	182, 183
aguja para sutura amígdalas Dupuy-Weiss.....	466	Arruga gancho para extraccion.....	375	Balfour separador abdominal.....	182, 183
aguja para sutura amígdalas Weiss-Dupuy.....	466	Arruga pinza capsular.....	391	Balfour-Us separador abdominal.....	184
aguja para sutura del paladar Claus.....	466	Arruga porta aguja.....	214	Ball and Socket pinza para campo.....	133
aguja para sutura del paladar Claus-Eicken.....	466	Arruga protector.....	378	Ballenger cuchillo para tabique nasal.....	436
aguja para sutura del paladar Eicken-Claus.....	466	Arruga-Gil pinza capsular.....	390	Ballenger elevador para el tabique nasal.....	439
aguja para sutura del paladar Nager.....	466	Arruga-Kalt pora aguja.....	214	Ballenger pinza para coger amígdalas.....	467
aguja pasa-hilo Demel.....	315	Arthur-Kirby pinza para fijacion.....	385	Ballenger-Hajek elevador para el tabique nasal.....	439
aguja Reverdin.....	220	articulacion para Kleinsasser.....	36	Ballenger-Sluder amigdalotomo.....	470
aguja Young Boomerang.....	220	asa Arit.....	378	Ballentine-Heany pinza para histerectomia.....	127
agujas de sutura.....	222, 223	asa Billeau.....	409	bandejas.....	620

Bane-Hartmann pinza gubia .....	237	Blake pinza para calculos biliares .....	530/2	Brown pinza de diseccion .....	83
Bangerter espátula para ciclodialisís .....	379	Blake-Mayo pinza para calculos biliares .....	530/2	Brown porta aguja .....	209
Baracani punta de pinza .....	472	Blakesley-Weil pinza nasal .....	426	Browne-Denis separador abdominal .....	185
Barany ensordecedor .....	405	blefarostato Arruga .....	370	Bruenings baja-lengua .....	451
Barbara aguja .....	419	blefarostato Axenfeld-Mellinger .....	370	Bruenings bisturi para amígdalas .....	466
Barbara gancho .....	419	blefarostato Barraquer (Colibri) .....	370	Bruenings cierranudos .....	468
Barbon-Lubet pinza nasal .....	424	blefarostato Bowman .....	370	Bruenings especulo auricular .....	401
Barkan cuchillo para goniotomía .....	373	blefarostato Burch-Lister .....	370	Bruenings pinza nasal .....	425
Barnhill cuchillo para vegetaciones adenoides .....	450	blefarostato Clark .....	370	Bruenings punta de pinza .....	472
Baron canula de succión .....	336	blefarostato Colibri (Barraquer) .....	370	Bruenings tubo de extensión .....	472
Barr especulo rectal .....	559	blefarostato Critchett .....	370	Brunetti cincel .....	268
barra de tracción Gerster .....	250	blefarostato Graefe .....	370	Brünings-Lucas cincel .....	260
Barraquer (Colibri) blefarostato .....	370	blefarostato Lancaster .....	371	Brünings-Lucas gubia .....	260
Barraquer (Colibri) pinza para iris .....	384	blefarostato Lister-Burch .....	370	Brunner costotomo .....	481
Barraquer Colibri tijera para oftalmología .....	75	blefarostato Mellinger .....	370	Brunner pinza intestinal .....	543
Barraquer cuchillo para queratoplastica .....	373	blefarostato Mellinger-Axenfeld .....	370	Brunner separador .....	167
Barraquer micro porta aguja .....	216, 217	blefarostato Murdock .....	370	Brunner sonda conductora .....	221, 221/1
Barraquer pinza depilatoria .....	395	blefarostato Smith .....	370	Bruns cucharilla cortante .....	251, 254
Barraquer pinza para fijación .....	390	blefarostato Week .....	370	Bruns tijera para vendaje .....	70
Barraquer-Katzin pinza para iris .....	384	blefarostato Williams .....	370	Bryant pinza para medicación .....	137
Barraquer-Troutmann micro porta aguja .....	216	blefarostato Ziegler .....	371	Buchwald baja-lengua .....	451
Barraquer-Stille pinza de disección .....	88	blefarostato Castroviejo .....	371	Buck cureta .....	407
Barrett pinza uterina .....	582	blefarostato Liebermann .....	371	Buck elevador para cuerpos extraños .....	412
Barton forceps obstétrico .....	603/2	blefarostato Mueller .....	371	Buck martillo de percusión .....	24
Barton tractor .....	603/2	blefarostato Park .....	371	Buck-Gramcko elevador .....	285
Baumgartner porta aguja .....	208	blefarostato Stevenson .....	371	Buie canula de aspiración rectal .....	566
Beacham amniotomo .....	586	Blohmke pinza para coger amígdalas .....	467	Buie-Smith separador rectal .....	561
Beichert rotador .....	379	Blount elevador .....	288	bujía dilatadora Dittel .....	554
Beck pinza para anastomosis .....	516, 520	Blount separador para rodilla .....	289	bujía dilatadora Guyon .....	554
Becker quistotomo .....	375	Blumenthal pinza gubia .....	236	bujía dilatadora Van Buren .....	554
Beckmann cuchillo para vegetaciones adenoides .....	450	Bodenhammer especulo rectal .....	559	Bülow-Gunar-Hey pinza cierra-tubo .....	130
Beckmann separador .....	176	Boerma forceps obstétrico .....	604	Bumm cureta uterina .....	597
Beckmann-Adson separador .....	175	Boettcher tijera para amígdalas .....	59	Bunell pasador de tendones .....	294
Beckmann-Eaton separador .....	176	Böhler estribo para extensión .....	312	Bunell perforador de mano .....	299
Beer pinza depilatoria .....	395	Böhler pinza cortante para huesos .....	241	Bunell separador para tendones .....	292
Beeson separador para yesos .....	232	Böhler pinza gubia .....	238	Bunge cucharilla para exenteración .....	378
Bellucci tijera auricular micro .....	413, 417	Boies elevador .....	277	Bunt clip para esterilización .....	227, 624
Belmont-Rumel tourniquet .....	528	bomba de aire .....	295	Burch horquilla fijadora .....	373
Bengolea pinza hemostática .....	112	bombilla de repuesto para laringoscopio .....	29, 30	Burch-Lister blefarostato .....	370
Bennett elevador .....	283	bomboneras .....	621	Burford-Finocchio separador costal .....	483
Bensaude proctoscopio .....	565	Bonaccolto pinza para estrabismo .....	385	Burke pinza para biopsia .....	590
Benson separador para piloro .....	544	Bonn Mod. pinza para sutura .....	386	Burrows-Jackson separador .....	189/2
Berens cuchillo de discisión .....	372	Bonn pinza para sutura .....	386	Busch tijera para cordón umbilical .....	64
Bergmann martillo .....	272	Bonney pinza de disección .....	88	Bushe cucharilla cortante .....	256
Bergmann tijera para vendaje .....	69/1	Boomerang Young aguja .....	220		
Bergmann-Schulze especulo rectal .....	560	Boomerang Young porta aguja .....	220	<b>C</b>	
Berke pinza muscular .....	389	Bose gancho para traqueotomía .....	477	caja para esterilización .....	618
Berlin Klinikum pinza cierra-tubo .....	129	Bose separador traqueal .....	476	caja para instrumentos .....	617
Berliner martillo de percusión .....	24	Boucheron especulo auricular .....	399	calibrador decimal Iwanson .....	624
Bernhard pinza de campo .....	133	Bowman aguja de discisión .....	374	calibre .....	26
Berry pinza para torcer hilo .....	319	Bowman blefarostato .....	370	calibre Townley .....	26
Bethune costotomo .....	481	Bowman sonda lacrimal .....	381	Canfield bisturi para amígdalas .....	466
Beyer pinza gubia .....	237, 238	Boyle-Davis abre-boca .....	455	canula Air Injection .....	394
Biemer aproximador .....	366	Boynton porta aguja .....	214	canula capsular Jensen .....	394
Biemer pinza para vasos .....	361	Boys-Allis pinza intestinal .....	538	canula de aspiración para mango de Wullstein	
Biemer-Müller aproximador .....	363	Bozemann pinza porta esponja .....	138	y Zöllner .....	337/1
Biel sierra para amputación .....	296	Bozemann porta aguja .....	211	canula de aspiración rectal Buie .....	566
Bill tractor .....	604	Bozemann-Douglas pinza porta esponja .....	138	canula de aspiración para mango de Zöllner	
Billeau asa .....	409	Brand mondador de tendones .....	294	y Wullstein .....	337/1
Bill-Luikart tractor .....	604	Brand pinza de agarre para tendones .....	293	canula de inyección Kleinsasser .....	36
Bircher-Ganske pinza para hueso .....	246	Braun cranioclasto .....	607	canula de irrigación y aspiración Bishop-Harmon .....	394/1
Birkett pinza hemostática .....	116	Braun depresor uterino .....	586	canula de irrigación y aspiración Harmon-Bishop .....	394/1
Bishop-Harman pinza para iris .....	386	Braun gancho de decapitación .....	607	canula de succión Baron .....	336
Bishop-Harmon canula de irrigación y aspiración .....	394/1	Braun pinza uterina .....	582	canula de succión Kleinsasser .....	36
bisturi nasal Joseph .....	434, 435	Braun-Stadler tijera para episiotomía .....	64	canula irrigación Eicken (Killian) .....	433
bisturi para amígdalas Abraham .....	466	brazalete para brazo .....	295	canula irrigación Killian (Eicken) .....	433
bisturi para amígdalas Bruenings .....	466	brazalete para femur .....	295	canula Killian .....	433/1
bisturi para amígdalas Canfield .....	466	Breast separador mamario .....	198	canula Lacrimal .....	394
bisturi para amígdalas Douglas .....	466	Breisky especulo vaginal .....	577	canula lacrimal McIntyre .....	394
bisturi para amígdalas Fisher .....	466	Bridge pinza hemostática .....	116	canula para lavador vascular Schmid .....	338
bisturi para fibroma Segond .....	594	Bristow elevador .....	290	canula para traqueotomía Chevalier-Jackson .....	479
bisturies .....	46	Brodie sonda acanalada .....	199	canula para traqueotomía Jackson-Chevalier .....	479
Blake cureta uterina .....	595	Brophy pinza de disección .....	84	canula para traqueotomía Luer .....	479

canula para traqueotomía Mosher-Wagener.....	477	cincel nasal Rubin .....	440	Collin separador .....	139
canula para traqueotomía Wagener-Mosher.....	477	cincel nasal Sheehan .....	441	Collin separador abdominal .....	190
canula Sheets.....	394/2	cincel nasal Silver.....	442	Collin-Duval pinza de disección .....	85
canula Simcoe.....	394/2	cincel nasal West .....	442/1	Collin-Farabeuf periostotomo .....	274
Carmalt pinza para espinas.....	91	cincel para cuerpos extraños Dix .....	374	Collin-Hartmann separador .....	141
Carmalt-Rochester pinza hemostática.....	109	cincel para el tabique nasal Freer .....	439	Collins-Mayo separador .....	141
Caroli pinza de agarre para tendones.....	293	cincel para extirpación Rollet.....	374	Colver pinza para coger amígdalas .....	467
Carpenter cuchillo para amígdalas .....	465	cincel Partsch.....	259	compas marcador Castroviejo .....	380
Cartilage-Martin tijera.....	65/1	cincel Petersen-Smith .....	261	Cone pinza sacabocado craneal.....	331
Caspar hemostático.....	258	cincel rompe-craneo.....	267	Connin-Amsler marcador .....	380
Caspar separador.....	179	cincel Smith-Petersen .....	261	Contour-Scalp separador.....	169
Castaneda pinza vascular para neonatales .....	527	cincel Stille .....	260	Converse cuchillo rinoplástico.....	435
Castroviejo blerarostato .....	371	cincel tamponador para huesos Passow .....	260	Converse separador.....	448
Castroviejo compas marcador .....	380	Cinelli cincel nasal .....	441	Cooley pinza traumática.....	99
Castroviejo cuchillo para disección .....	372	Circumflex micro tijera .....	76	Cooley pinza para anastomosis .....	519-520/1, 520/4
Castroviejo dilatador lacrimal.....	381	Citelli pinza sacabocado .....	430	Cooley pinza para aorta .....	520/3
Castroviejo espátula para ciclodialis .....	379	cizalla para yesos Stille .....	229	Cooley pinza para cateter .....	510
Castroviejo pinza capsular .....	391	clamp trauma bulldog .....	100	Cooley pinza vascular .....	520
Castroviejo pinza para fijación .....	390	clamp trauma bulldog DeBakey.....	100, 103	Cooley pinza vascular de uso múltiple.....	518-520, 520/2
Castroviejo pinza para sutura .....	392	clamp trauma bulldog Glover.....	100, 103	Cooley pinza vascular pediátrica .....	522
Castroviejo porta aguja .....	215	clamp bulldog de Titano .....	102	Cooley separador .....	148
Castroviejo rompe hojas .....	45	clamp bulldog DeBakey-Dietrich .....	101	Cooley separador costal .....	485, 487
Castroviejo tijera para corneales.....	79	clamp bulldog Dietrich .....	101	Cooley-Derra pinza para anastomosis.....	519
Castroviejo tijera para iridectomía.....	79	clamp bulldog Dietrich-DeBakey .....	101	Cooper aguja para ligadura.....	219
Castroviejo-Micro porta aguja.....	215	clamp umbilical Collin .....	605	copas graduadas.....	620
Castroviejo-Standard micro porta aguja .....	216	clamp umbilical Kane .....	605	Cordes punta de pinza .....	472
cateter auricular Hartmann.....	408	Clar lámpara frontal.....	22	Coronal Blow Lift separador .....	198
cateter Coxeter.....	555	Clark blefarostato .....	370	Corwin-Hegar pinza para torcer hilo .....	319
cateter metálicos.....	555	Claus aguja para sutura del paladar .....	466	Coryllos (Thorax) separador .....	166
cateter Walthers.....	555	Claus-Eicken aguja para sutura del paladar .....	466	Coryllos costotomo .....	480
Cattin cuchillo para amputación.....	44	Claus-Killian cincel nasal .....	442/1	Cos pinza auricular micro.....	414
cauterio Todd-Wadsworth .....	378	Clayman gancho .....	376	costotomo .....	480, 481
cauterio Wadsworth-Todd .....	378	Cleveland pinza gubia .....	235	costotomo Bethune.....	481
Cawood-Minnesota baja-lengua.....	451	clip para esterilización Bunt .....	227, 624	costotomo Brunner .....	481
cepillo para uñas.....	611	clip para esterilización Mayo.....	227, 624	costotomo Coryllos .....	480
cesta de esterilización .....	622, 623	Clip-Jones pinza de campo .....	132	costotomo Frey-Sauerbruch .....	481
Chandler elevador .....	282	clips para aneurisma Yasargil .....	345-356	costotomo Giertz-Stille.....	481
Chaput pinza hemostática .....	110	clips para vasos de Müller .....	365	costotomo Gluck .....	480
Charnley separador abdominal .....	289	Cloward pinza cortante para laminectomía .....	342	costotomo Sauerbruch.....	481
Charniere sierra para amputación.....	296	Cloward separador .....	178/1-178/4	costotomo Sauerbruch-Frey .....	481
Cheatle pinza para esterilización .....	227	Cloward separador para cuerpo vertebral.....	339	costotomo Stille .....	480
Chelsea-Eaton anoscopio .....	563	Cloward separador para tejido cervical.....	339	costotomo Stille-Giertz.....	481
Cheron pinza porta esponja.....	137	coagulación bipolar.....	628-633	Cottle (Maltz) lima nasal .....	444
Cherry separador para laminectomía.....	488	Coakley cureta para seno .....	449	Cottle cincel nasal .....	440
Chevalier-Jackson canula para traqueotomía .....	479	Coakley trocar para seno maxilar .....	204	Cottle cuchillo rinoplástico.....	435
Chevalier-Jackson pinza para bronco-esofagoscopia.....	473	Cobb cureta.....	252	Cottle elevador para el tabique nasal .....	439
Cheyne-Watson disecador.....	199	Cobb gubia.....	262	Cottle especulo nasal .....	423
Cheyne-Watson elevador .....	283	Cobb periostotomo .....	280	Cottle gancho para la piel.....	448
Childe pinza para aplicar agrafes.....	224	Cobra-Aufranc separador .....	289	Cottle Joseph elevador para el tabique nasal .....	439
cierra-nudo auricular Krause .....	411	Colclough pinza sacabocado para discos .....		Cottle martillo .....	273
cierra-nudo auricular Wilde .....	411	intervertebral .....	344/1	Cottle pinza para columna .....	448
cierra-nudo rectal Yeoman .....	566	Colibri (Barraquer) blefarostato .....	370	Cottle pinza para fijación.....	410
cierranudos Bruenings .....	468	Colibri (Troutman) pinza para iris.....	384	Cottle retractor nasal .....	447, 447/1
cierranudos Eves.....	468	Colibri Barraquer tijera para oftalmología .....	75	Cottle tijera nasal.....	59
cierra-tubos Hoffmann .....	624	Colibri pinza para iris.....	384	Cottle tijera para cirugía.....	56
cierra-tubos Simplex .....	624	College-London pinza dental .....	93	Cottle-Kazanjian pinza cortante para huesos.....	241
cincel .....	259-261, 264-265	Coller-Crile pinza hemostática .....	106	Cottle-Neivert gancho para la piel.....	448
cincel Alexander .....	259	Collier pelvimetro .....	605	Coxeter cateter.....	555
cincel Brunetti .....	268	Collier porta aguja .....	208	Crafoord pinza hemostática .....	118
cincel Brünings-Lucas .....	260	Collin clamp umbilical .....	605	Crafoord tijera pulmonar .....	65/2
cincel de esternon Lebsche .....	267	Collin dinamómetro .....	25	Crafoord-Sellers pinza hemostática.....	119
cincel Hibbs.....	265	Collin especulo vaginal .....	570	cranioclasto Braun .....	607
cincel Lucas-Brünings .....	260	Collin histerometro .....	586	cranioclasto Tarnier .....	607
cincel nasal Anderson-Neivert .....	442	Collin Loktite separador abdominal .....	191	Crego elevador .....	282
cincel nasal Cinelli.....	441	Collin mango de bisturí .....	40	Crile gancho para nervio.....	328
cincel nasal Claus-Killian .....	442/1	Collin martillo.....	270	Crile pinza hemostática.....	107
cincel nasal Cottle .....	440	Collin pelvimetro.....	605	Crile porta aguja .....	213
cincel nasal Fomon .....	441	Collin pinza hemostática .....	110	Crile separador.....	140
cincel nasal Freer .....	442/1	Collin pinza para el útero .....	585	Crile-Coller pinza hemostática .....	106
cincel nasal Hajek .....	442/1	Collin pinza para quitar agrafes .....	224	Crile-Murray porta aguja .....	209
cincel nasal Killian .....	442/1	Collin pinza para tejido.....	539	Crile-Rankin pinza hemostática .....	107
cincel nasal Killian-Claus .....	442/1	Collin pinza porta esponja.....	137	Crile-Wood porta aguja .....	209
cincel nasal Neivert-Anderson .....	442	Collin pinza tira-lengua.....	453	Critchett blefarostato.....	370

Crutchfield perforador inicial.....	327	cuchillo para reseccion .....	47	Davis-Boyle abre-boca.....	455
Crutchfield pinza de traccion craneal .....	327	cuchillo para reseccion Langenbeck .....	47	Davis-Meyer abre-boca.....	457
cubeta para placenta .....	621/1	cuchillo para tabique nasal Ballenger .....	436	Davis-Russel baja-lengua.....	458
cubeta Petri.....	620	cuchillo para tabique nasal Freer .....	434	Day gancho auricular .....	409
cubetas .....	619-621/1	cuchillo para vegetaciones adenoides Barnhill.....	450	Dean cuchillo para iris .....	372
cuchara medicinal .....	268	cuchillo para vegetaciones adenoides Beckmann .....	450	Dean tijera para amigdalas .....	59
cuchara para calculos biliares Desjardins.....	534	cuchillo para vegetaciones adenoides St.Clair-Thomson.....	450	Deaver separador.....	145, 146
cuchara para calculos biliares Fergusson .....	533	cuchillo para vegetaciones adenoides Thomson-St.Clair.....	450	Deaver tijera de diseccion.....	52
cuchara para calculos biliares Koerte-Luer .....	533	cuchillo para vendaje enyesado Esmarch.....	233	Deaver-Grip separador.....	146
cuchara para calculos biliares Luer-Koerte.....	533	cuchillo para vendaje enyesado Hopkins .....	233	DeBakey clamp trauma bulldog .....	100, 103
cuchara para calculos biliares Mayo .....	534	cuchillo para vendaje enyesado Reiner .....	233	DeBakey dilatador vascular .....	529
cuchara para calculos biliares Moor .....	531	cuchillo para vendaje enyesado Wigmore .....	229	DeBakey pinza atraumatica .....	98, 99
cuchara y gancho Gross .....	409	cuchillo Plester .....	418	DeBakey pinza para anastomosis.....	505, 515
cucharilla cortante .....	251-257	cuchillo rinoplastico Converse .....	435	DeBakey pinza para aneurisma de la aorta.....	496-498
cucharilla cortante Bruns .....	251, 254	cuchillo rinoplastico Cottle .....	435	DeBakey pinza para ligadura .....	493, 499-500
cucharilla cortante Bushe.....	256	cuchillo Rosen .....	418	DeBakey pinza para vasos perifericos.....	494
cucharilla cortante Daubenspeck.....	255	cuchillo Schuhknecht .....	418	DeBakey pinza vascular .....	
cucharilla cortante Halle.....	253	cuchillo Tabb .....	418	de uso multiple .....	495/2, 507, 508, 514, 515
cucharilla cortante Jacobson.....	257	cuchillo Wulstein .....	418	DeBakey pinza vascular pediatrica.....	516, 517
cucharilla cortante Jansen .....	257	Cullen-Wertheim pinza para histerectomia .....	125	DeBakey porta aguja.....	210
cucharilla cortante Lempert .....	256	cureta Antrum.....	435	DeBakey separador.....	189/1
cucharilla cortante Martini.....	257	cureta aspiradora .....	600	DeBakey tijera .....	60
cucharilla cortante Reda .....	256	cureta aspiradora para biopsia uterina Novak.....	587	DeBakey tijera vascular.....	61
cucharilla cortante Schede.....	251	cureta aspiradora para biopsia uterina Randall .....	587	DeBakey-Bahnon pinza para aneurisma.....	506
cucharilla cortante Scoville .....	253	cureta Buck .....	407	DeBakey-Dietrich clamp bulldog .....	101
cucharilla cortante Spinal.....	253	cureta Cobb .....	252	DeBakey-Mixer pinza para ligaduras.....	499/2
cucharilla cortante Spratt .....	251	cureta Faulkner.....	449	DeBakey-Morris pinza para la aorta .....	506
cucharilla cortante Voikmann.....	251, 257	cureta House .....	420	DeBakey-Mosquito pinza hemostatica .....	509
cucharilla cortante Williger .....	255, 257	cureta para aborto Pestalozza .....	606	DeBakey-Pean pinza hemostatica atraumatica .....	513
cucharilla para aborto Cuzzi .....	606	cureta para biopsia Heany .....	587	DeBakey-Rankin pinza hemostatica atraumatica .....	512
cucharilla para aborto Wallich .....	607	cureta para biopsia Kevorkian .....	587	DeBakey-Rumel pinza para ligaduras.....	499
cucharilla para cataratas Daviel.....	377	cureta para biopsia Mod. Muenchen .....	587	DeBakey-Satinsky pinza para oclusion tangencial.....	502
cucharilla para cataratas Graefe.....	377	cureta para biopsia Muenchen Mod.....	587	DeBakey-Semb pinza para ligadura y la aorta .....	499
cucharilla para cataratas Knapp .....	378	cureta para cuerpos extraños Alvis .....	374	DeBoer separador costal .....	486
cucharilla para chalazion Axenfeld.....	377	cureta para hipofisis .....	334	Decker pinza cortante para laminectomia .....	341
cucharilla para chalazion Hebra .....	377	cureta para hipofisis Ray .....	334	dedal.....	311
cucharilla para chalazion Meyhoefer.....	377	cureta para lupus Fox .....	608	Dejerine martillo de percusion.....	24
cucharilla para exenteracion Bunge.....	378	cureta para lupus Piffard .....	608	Delee especulo vaginal .....	574
cucharilla uterina Simon .....	594	cureta para seno Coakley .....	449	DeLee forceps obstetrico .....	602
cucharra para sangre .....	268, 621	cureta uterina Blake .....	595	DeMartel guia conductora.....	330
cuchillo auricular Politzer .....	408	cureta uterina Bumm .....	597	DeMartel-Wolfson pinza para anastomosis .....	546
cuchillo auricular Sexton .....	408	cureta uterina Gourdet .....	599	DeMartel-Wolfson pinza para cerrar clamps .....	546
cuchillo corneal Elschmig .....	373	cureta uterina Recamier .....	597	DeMartel-Wolfson porta-clamps .....	546
cuchillo corneal Gill .....	373	cureta uterina Schröder.....	595	Demel aguja pasa-hilo.....	315
cuchillo corneal Took.....	373	cureta uterina Sims .....	597	Demel tensor de cierra-hilo.....	315
cuchillo de discision Berens.....	372	cureta uterina Thomas .....	599	Denhart abre-boca .....	454
cuchillo de discision Jaeger .....	372	Cusco especulo vaginal .....	570, 571	Denis-Browne separador abdominal .....	185
cuchillo de hoz Reda.....	435	Cushing espátula cerebral .....	336, 369	depressor para epiglotis Reichert.....	471
cuchillo interoseo .....	44	Cushing gancho para nervio .....	328	depressor uterino Braun .....	586
cuchillo para amigdales Carpenter .....	465	Cushing pinza cortante para laminectomia .....	340	depressor uterino Sims .....	586
cuchillo para amputacion Catlin.....	44	Cushing pinza de diseccion .....	83	Derf porta aguja.....	208
cuchillo para amputacion Langenbeck.....	44	Cushing separador .....	151- 153	dermatomo Humby .....	50
cuchillo para amputacion Liston.....	44	Cushing-Taylor pinza de diseccion .....	87	dermatomo Schink .....	49
cuchillo para amputacion Reda .....	44	Cuzzi cucharilla para aborto .....	606	dermatomo Silver .....	50
cuchillo para iris Dean .....	372	Czerny especulo rectal .....	559	dermatomo Watson .....	50
cuchillo para autopsia .....	48	Czerny pinza uterina .....	584	Derra pinza para anastomosis .....	515
cuchillo para autopsia Virchow .....	48	Czerny separador.....	141	Derra-Cooley pinza para anastomosis .....	519
cuchillo para cataratas Deutschmann.....	371	D		D'Errico separador para la raiz de nervios .....	329/2
cuchillo para cataratas Graefe.....	371	D		Deschamps aguja para ligadura .....	218
cuchillo para cerebro Virchow.....	48	D		Desjardins cuchara para calculos biliares.....	534
cuchillo para discision Wheeler.....	373	D		Desjardins explorador para calculos biliares .....	531
cuchillo para discision Castroviejo.....	372	D		Desjardins pinza hemostatica .....	121
cuchillo para discision Graefe.....	372	D		Desjardins pinza para calculos biliares .....	530/2
cuchillo para discision Ziegler .....	373	D		Desmarres pinza para chalazion .....	393
cuchillo para falanges .....	44	D		Desmarres separador .....	151
cuchillo para goniotomia Barkan .....	373	D		desobitador de vena .....	202
cuchillo para goniotomia Scheie.....	373	D		destornillador .....	323, 324
cuchillo para iris Dean .....	372	D		destornillador Lane .....	323, 324
cuchillo para iris Knapp.....	372	D		destornillador Williams .....	323
cuchillo para iris Ziegler .....	372	D		Deutschmann cuchillo para cataratas.....	371
cuchillo para organos .....	48	D		Devilbiss pinza sacabocado craneal.....	332
cuchillo para periostio .....	47	D		diapason Hartmann .....	403
cuchillo para queratoplastica Barraquer .....	373	D		diapason Reda .....	403
cuchillo para queratoplastica Paufigue.....	373	D			
		dandy pinza para vasos perifericos .....	494, 495		
		Dandy gancho para nervio .....	328		
		Dandy pinza hemostatica.....	109		
		Dardik pinza vascular .....	509/1		
		Darling separador .....	178		
		Dartiques pinza para el utero .....	585		
		Dastoor pinza para estrabismo .....	386		
		Daubenspeck cucharilla cortante .....	255		
		Davidson (Scapula) separador .....	166		
		Daviel cucharilla para cataratas .....	377		
		Davis aguja para cuerpos extraños .....	374		
		Davis elevador para duramadre .....	332		
		Davis espátula cerebral.....	337		
		Davis pinza para esterilizacion de jeringas .....	227		



diapason Lucae .....	404	Dupuy-Weiss aguja para sutura amigdalas .....	466	elevador para el tabique nasal Joseph Cottle .....	439
diapason Rydel-Seiffert .....	404	Durante pinza de diseccion .....	88	elevador para el tabique nasal Killian .....	438, 439
diapason Seiffert-Rydel .....	404	Duval pinza de diseccion .....	85	elevador para el tabique nasal Masing .....	437
diaposones .....	403, 404	Duval pinza para tejido .....	539	elevador para el tabique nasal McKenty .....	437, 438
Dick-Schmieden aguja para ligadura .....	219	Duval-Collin pinza de diseccion .....	85	elevador para el tabique nasal Pennington .....	438
Dieffenbach serra-fina .....	104			elevador para el tabique nasal Pierce .....	438
Dieter pinza auricular micro .....	414	E		elevador para el tabique nasal Roger .....	437
Dietrich clamp bulldog .....	101	Eastman-Richardson separador .....	142	elevador Sayre .....	281
Dietrich pinza para la aorta .....	510	Eaton-Chelsea anoscopio .....	563	elevador Trethowan Lane .....	290
Dietrich tijera vascular .....	60	Echlin pinza gubia .....	240	elevador Verbrugge-Müller .....	286/2
Dietrich-DeBakey clamp bulldog .....	101	ECO "T" y "C" estuche de diagnostico .....	16	elevador Watson-Cheyne .....	283
dilatador lacrimal Castroviejo .....	381	Eicken (Killian) canula irrigacion .....	433	Elliot forceps obstetrico .....	603
dilatador lacrimal Wilder .....	381	Eicken-Claus aguja para sutura del paladar .....	466	Ellis gubia para cuerpos extraños .....	374
dilatador lacrimal Ziegler .....	381	electrocirugia .....	628-634	Elschnig cuchillo corneal .....	373
dilatador para conductos biliares Bakes .....	532	elevador .....	281-291	Elschnig espátula para ciclodialisís .....	379
dilatador para el seno Halle-Ritter .....	433	elevador Adson .....	282	Elschnig pinza capsular .....	391
dilatador para el seno Ritter-Halle .....	433	elevador Alderdyce .....	282	Elschnig pinza para fijacion .....	389
dilatador traqueal Baby-Trousseau .....	476	elevador auricular Jansen-Zaufal .....	409	Emmet gancho para fistulas .....	594
dilatador traqueal Laborde .....	476	elevador auricular Zaufal .....	409	empujador de alambres Erich .....	461/2
dilatador traqueal Trousseau-Baby .....	476	elevador auricular Zaufal-Jansen .....	409	Engel sierra para vendajes enyesados .....	229
dilatador uterino Goodell .....	581	elevador Bennett .....	283	ensordecedor Barany .....	405
dilatador uterino Hank .....	580	elevador Blount .....	288	Enucleation tijera .....	58
dilatador uterino Hegar .....	578, 579	elevador Boies .....	277	Epker osteotomo .....	464/2
dilatador uterino Pratt .....	580	elevador Bristow .....	290	Eppendorfer pinza para biopsia .....	590
dilatador uterino Sims .....	581	elevador Buck-Gramcko .....	285	Erich empujador de alambres .....	461/2
dilatador uterino Wylie .....	581	elevador Chandler .....	282	escariador .....	304
dilatador vascular DeBakey .....	529	elevador Cheyne-Watson .....	283	escariador Perthes .....	304
dinamómetro Collin .....	25	elevador Crego .....	282	esclerotomo Guyton-Lundsgaard .....	373
Dingman elevador .....	463/3	elevador Dingman .....	463/3	esclerotomo Lundsgaard .....	373
Dingman periostotomo .....	463	elevador Gramcko-Buck .....	285	esclerotomo Lundsgaard-Guyton .....	373
Dingmann abre-boca .....	456	elevador Hohmann .....	284, 285	escofina nasal Miller .....	444
Dingmann pinza para hueso .....	246	elevador Hohmann Mini .....	286	escofina nasal Peet .....	446
Diplomat esfigmomanómetro .....	5	elevador Hohmann-Lange .....	286	escofina nasal Wiener .....	443
disecador Cheyne-Watson .....	199	elevador Key .....	282	escupidora .....	621/1
disecador corneal Green .....	374	elevador König .....	284	esfigmomanómetro Babyphon .....	10
disecador corneal Paton .....	373	elevador Lane .....	290	esfigmomanómetro Diplomat .....	5
disecador para el saco lacrimal Lang .....	378	elevador Lane Trethowan .....	290	esfigmomanómetro Exacta-Spezial .....	8
disecador vascular Robb .....	530	elevador Lane-Murphy .....	283	esfigmomanómetro Minimus II .....	11
disecador Watson-Cheyne .....	199	elevador Lange-Hohmann .....	286	esfigmomanómetro Minimus III .....	12
disector Fisch .....	420	elevador Lempert .....	420	esfigmomanómetro Nova .....	7
disector Gorney .....	277	elevador Masing .....	437	esfigmomanómetro Nova-Presameter .....	6
dispensador de cepillos .....	611	elevador McDonald .....	283	esfigmomanómetro Precisa .....	9
Dix instrumento para brocas filiformes .....	310	elevador Mini Hohmann .....	286	esfigmomanómetro Presameter-Nova .....	6
Dittel buija dilatadora .....	554	elevador Müller-Verbrugge .....	286/2	esfigmomanómetro Spezial-Exacta .....	8
Dix cincel para cuerpos extraños .....	374	elevador Murphy-Lane .....	283	Esmarch cuchillo para vendaje enyesado .....	233
Dix instrumento para cuerpo extraños .....	380	elevador Obwegeser .....	461/1	Esmarch tijera para vendaje .....	69/2
Doren pinza para biopsia .....	588	elevador para amigdalas Reinke-Lopez .....	465	Esmarch vendaje de compresion .....	296
Doughty baja-lengua .....	458	elevador para amigdales Henke .....	465	espátula .....	143/1-144, 203, 336-337,
Doughty-Kilner abre-boca .....	456	elevador para amigdales Hurd .....	465	.....	369, 378-379, 489/2, 530, 552, 612/1
Douglas bisturí para amigdalas .....	466	elevador para amigdales Lopez-Reinke .....	465	espátula abdominal Haberer .....	143/3
Douglas pinza depilatoria .....	395	elevador para amigdales Yankauer .....	465	espátula abdominal Kader .....	143/3
Douglas trocar .....	204	elevador para cuerpos extraños Buck .....	412	espátula abdominal Kümmel .....	143/4, 144
Douglas-Bozemann pinza porta esponja .....	138	elevador para cuerpos extraños Quire .....	412	espátula abdominal Ribbon .....	143/1
Down-Mini-Townsend pinza para biopsia .....	591	elevador para duramadre .....	332, 333	espátula cerebral Cushing .....	336, 369
Down-Tischler pinza para biopsia .....	591	elevador para duramadre Davis .....	332	espátula cerebral Davis .....	337
Doyen especulo vaginal .....	574	elevador para duramadre Frazier .....	333	espátula cerebral Heifetz .....	369
Doyen estilete acanalado .....	199	elevador para duramadre Hoen .....	333	espátula cerebral Olivecrona .....	336
Doyen periostotomo .....	278	elevador para duramadre Horsley .....	333	espátula Locke .....	612/1
Doyen pinza de campo .....	133	elevador para duramadre Milligan .....	332	espátula para ciclodialisís Bangertner .....	379
Doyen pinza intestinal .....	540	elevador para duramadre Olivecrona .....	332	espátula para ciclodialisís Castroviejo .....	379
Doyen pinza para polipos uterinos .....	585	elevador para duramadre Penfield .....	333	espátula para ciclodialisís Elschnig .....	379
Doyen separador .....	163	elevador para duramadre Sachs .....	332	espátula para ciclodialisís Hirschman .....	379
Doyen separador abdominal .....	189/1	elevador para duramadre Toennis .....	332	espátula para ciclodialisís Wheeler .....	379
Doyen tijera ginecologica .....	63	elevador para duramadre Woodson .....	333	espátula para enucleacion Wells .....	378
Doyen tirabuzon para fibroma .....	594	elevador para el tabique nasal Ballenger .....	439	espátula para iris Wecker .....	378
Doyen-Baby pinza intestinal .....	540	elevador para el tabique nasal Ballenger-Hajek .....	439	espátula para la intima Robb .....	530
Doyen-Jansen (Molt) abre-boca .....	454	elevador para el tabique nasal Cottle .....	439	espátula pulmonar Allison .....	489/2
Doyen-Stille separador .....	167	elevador para el tabique nasal Cottle Joseph .....	439	espátula vesical Kocher .....	552
Dubois tijera ginecologica .....	63	elevador para el tabique nasal Freer .....	437	espátula vesical Legueu .....	552
Duehrsen pinza de diseccion .....	84	elevador para el tabique nasal Hajek-Ballenger .....	439	espátulas abdominales .....	143-144
Duplay pinza porta-esponja .....	134	elevador para el tabique nasal Halle .....	437	espátulas para la intima .....	530-530/1
Duplay pinza uterina .....	582	elevador para el tabique nasal Howarth .....	438	especulo auricular .....	399-402
Duplex stetoscopio .....	23	elevador para el tabique nasal Joseph .....	437	especulo auricular Boucheron .....	399

especulo auricular Bruenings.....	401	estuche de diagnostico Ri-Mini.....	17	forceps obstetrico Elliot.....	603
especulo auricular Gruber.....	399	estuche de diagnostico Uni I.....	13	forceps obstetrico Kielland.....	602
especulo auricular Hartmann.....	399	estuche de diagnostico Uni II.....	14	forceps obstetrico Kielland-Luikart.....	603
especulo auricular Holmgren-Richnau.....	400	estuche de diagnostico Uni III.....	15	forceps obstetrico Luikart.....	603
especulo auricular Politzer.....	399	estuche para autopsia.....	269	forceps obstetrico Luikart-Kielland.....	603
especulo auricular Richnau-Holmgren.....	400	estuche para esterilizar agujas.....	615	forceps obstetrico Luikart-McLean-Tucker.....	603/1
especulo auricular Siegle.....	402	estuche para sutura Standard.....	226	forceps obstetrico Luikart-Simpson.....	603
especulo auricular Toynbee.....	399	Eves cierranudos.....	468	forceps obstetrico McLean.....	603/1
especulo endocervical Kogan.....	577	Exacta-Spezial esfigmomanómetro.....	8	forceps obstetrico McLean-Tucker.....	603/1
especulo Friedmann.....	477, 577	Excenter Reda tijera para vendaje.....	69/2	forceps obstetrico McLean-Tucker-Luikart.....	603/1
especulo nasal.....	421-423	explorador para calculos biliares Desjardins.....	531	forceps obstetrico Naegle.....	603
especulo nasal Cottle.....	423	explorador para calculos biliares Moynihan.....	531	forceps obstetrico Piper.....	604
especulo nasal Halle-Hartmann.....	421	extractor Künstscher.....	322	forceps obstetrico Simpson.....	602
especulo nasal Halle-Tieck.....	423	extractor/impactor para clavos.....	321-322/1	forceps obstetrico Simpson-Braun.....	602
especulo nasal Hartmann.....	422			forceps obstetrico Simpson-Luikart.....	603
especulo nasal Hartmann-Halle.....	421			forceps obstetrico Tarnier.....	604
especulo nasal Killian.....	423	F		forceps obstetrico Tucker-Luikart-McLean.....	603/1
especulo nasal Mod. Vienna.....	421	face lift tijera Freeman.....	73	forceps obstetrico Tucker-McLean.....	603/1
especulo nasal Reda.....	423	face lift tijera Gorney.....	73	forceps obstetrico Tucker-McLean.....	603/1
especulo nasal Thudichum.....	421	face lift tijera Joseph Peck.....	73	forceps obstetrico Wrigley.....	602
especulo nasal Tieck-Halle.....	423	face lift tijera kaye.....	73	forceps obstetricos Luikart-McLean.....	603/1
especulo nasal Vienna Mod.....	421	face lift tijera Peck Joseph.....	73	forceps obstetricos McLean-Luikart.....	603/1
especulo nasal Voltolini.....	421	face lift tijera Rees.....	73	forceps obstetricos Thierry.....	603
especulo rectal.....	559-561	Fansler protoscopio.....	564	Foregger juego de laringoscopia.....	31
especulo rectal Alan-Parks.....	561	Fansler-Ives anoscopio.....	562	Foregger laringoscopia.....	29
especulo rectal Barr.....	559	Farabeuf periostotomo.....	274	Fox cureta para lupus.....	608
especulo rectal Bergmann-Schulze.....	560	Farabeuf pinza para hueso.....	243	Fox-Goldmann tijera para encias.....	67
especulo rectal Bodenhammer.....	559	Farabeuf separador.....	139	Fraenkel pinza para laringe.....	471
especulo rectal Czerny.....	559	Farabeuf-Collin periostotomo.....	274	Fraenkel punta de pinza.....	472
especulo rectal Ferguson-Hill.....	560	Farabeuf-Lambotte pinza para hueso.....	243	Francis aguja para cuerpos extraños.....	374
especulo rectal Hill-Ferguson.....	560	Farrell porta-algodon.....	203	Frazier elevador para duramadre.....	333
especulo rectal Mathieu.....	560	Faulkner cureta.....	449	Frazier gancho.....	148/2
especulo rectal Parks-Alan.....	561	Faure pinza para biopsia.....	588	Frazier separador abdominal.....	181
especulo rectal Pratt.....	559	Faure pinza para peritoneo.....	123	Frazier/Ferguson tubo de aspiracion.....	337
especulo rectal Sawyer.....	560	Favaloro tijera vascular.....	61	Freeman separador.....	198
especulo rectal Schulze-Bergmann.....	560	Favaloro-Morse separador costal.....	484	Freeman tijera face lift.....	73
especulo rectal Sims.....	559	Fehland pinza intestinal.....	542	Freer cincel nasal.....	442/1
especulo vaginal.....	569-577	Feilchenfeld pinza para espinas.....	91	Freer cincel para el tabique nasal.....	439
especulo vaginal Auvard.....	576	Feldheim pinza para huesos.....	249	Freer cuchillo para tabique nasal.....	434
especulo vaginal Breisky.....	577	Ferguson-Hill especulo rectal.....	560	Freer elevador para el tabique nasal.....	437
especulo vaginal Collin.....	570	Ferguson cuchara para calculos biliares.....	533	Freer gancho para la piel.....	448
especulo vaginal Cosco.....	570, 571	Ferguson pinza hemostatica.....	109	Frenzel anteojos para nistagmo.....	20
especulo vaginal Delee.....	574	Ferguson pinza para hueso.....	243	Frenzel baja-lengua.....	451
especulo vaginal Doyen.....	574	Ferguson tijera para intestino.....	66	Frey-Sauerbruch costotomo.....	481
especulo vaginal Grave.....	570	Ferguson tubo de aspiracion.....	337	Friedmann especulo.....	477, 577
especulo vaginal Jackson.....	573	Ferguson/Frazier tubo de aspiracion.....	337	Friedmann micro pinza gubia.....	234
especulo vaginal Joll.....	477, 577	Ferrera separador para cirugia plastica.....	197	Friedmann mini pinza gubia.....	234
especulo vaginal Kallmorgen.....	573	Ferris-Smith pinza cortante para laminectomia.....	343	Friedmann pinza gubia.....	234
especulo vaginal Kristeller.....	572	Ferris-Smith pinza de diseccion.....	85	Friedmann separador.....	477, 577
especulo vaginal Landau.....	577	Ferris-Smith-Kerrison pinza sacabocado para discos intervertebral.....	344, 344/2	Fritsch separador.....	163
especulo vaginal More-Vu.....	569	Finocchetto pinza bronquial.....	490	Frykholm pinza gubia.....	240
especulo vaginal Kreisky.....	577	Finocchetto porta aguja.....	211	Fuchs pinza capsular.....	391
especulo vaginal O'Connor-O'Sullivan.....	576	Finocchetto separador costal.....	482, 484	Fuchsig pinza hemostatica.....	113
especulo vaginal O'Sullivan-O'Connor.....	576	Finocchetto-Burford separador costal.....	483		
especulo vaginal Pederson.....	570	Finocchetto-Rienhoff separador costal.....	486	G	
especulo vaginal Scherbak.....	575	Finsen separador.....	168	Gallaher lima para seno.....	446
especulo vaginal Semm.....	571	Fisch disector.....	420	gancho Frazier.....	148/2
especulo vaginal Sims.....	573	Fisch gancho para duramadre.....	335	gancho Graefe.....	148/2
especulo vaginal Trelat.....	571	Fischer pinza para iris.....	384	gancho Guthrie.....	148/2
especulo vaginal Vu-More.....	569	Fish sonda.....	199	gancho Joseph.....	149
espejo laringeo.....	423, 473	Fisher bisturi para amigdalas.....	466	gancho Kleinert-Kutz.....	149
espejo laringeo Michel.....	423	Foerster pinza para iris.....	383	gancho Kutz-Kleinert.....	149
estetoscopio Anestophon.....	23	Foerster porta esponjas.....	136	gancho Lahey.....	149
estetoscopio Duplex.....	23	Fomon cincel nasal.....	441	gancho nasal Fomon.....	447/1
estetoscopio Pinard.....	23	Fomon gancho nasal.....	447/1	gancho abotonado Lucac.....	409
estilite abotonado.....	199	Fomon lima nasal.....	444, 445	gancho abotonado Wagener.....	409
estilite acanalado abotonado.....	199	Fomon periostotomo.....	277	gancho auricular Day.....	409
estilite acanalado Doyen.....	199	Fomon tijera nasal.....	58	gancho Barbara.....	419
estilite hoja mirte.....	199	Fomon tijera para rinoplastia.....	65/1	gancho Clayman.....	376
estribo para extension Böhler.....	312	forceps obstetrico Barton.....	603/2	gancho cutaneo Kilner.....	608
estribo para extension Kirschner.....	312	forceps obstetrico Boerma.....	604	gancho de decapitacion Braun.....	607
estribo para extension Kirschner U.S.....	312	forceps obstetrico DeLee.....	602	gancho de menton Obwegeser.....	461/1
estribo para extension U.S. Kirschner.....	312			gancho extractor.....	322
estuche de diagnostico ECO "T" y ECO "C".....	16			gancho Gass.....	376

gancho Kirschner.....313	Good tijera para amigdalas .....59	H
gancho Klapp .....150	Goodell dilatador uterino.....581	Haberer espátula abdominal .....143/3
gancho Knapp.....375	Gorney disector .....277	Haberisser-Mayo pinza para torcer hilo .....319
gancho McGee.....419	Gorney tijera face lift.....73	Haglund-Stille separador para yesos.....232
gancho muscular.....267, 375	Gosset separador abdominal.....181	Haight separador costal .....487
gancho muscular Green.....375	Gourdet cureta uterina .....599	Hajek cinceal nasal .....442/1
gancho obstetrico Smellie.....605	Gradle pinza depiladora.....395	Hajek martillo.....273
gancho para cristalino Stevens.....375	Gradle tijera para oftalmologia.....57	Hajek-Ballenger elevador para el tabique nasal .....439
gancho para duramadre.....335	Graefe blefarostato.....370	Hajek-Kofler pinza cortante.....429
gancho para duramadre Adson .....329	Graefe cucharilla para cataratas.....377	Hajek-Kofler pinza sacabocado.....431
gancho para duramadre Fisch.....335	Graefe cuchillo para cataratas.....371	Halle cucharilla cortante.....253
gancho para estrabismo Graefe.....375	Graefe cuchillo para discision.....372	Halle elevador para el tabique nasal.....437
gancho para estrabismo Jameson.....375	Graefe gancho.....148/2	Halle-Hartmann espejulo nasal.....421
gancho para extraccion Arruga.....375	Graefe gancho para estrabismo.....375	Halle-Ritter dilatador para el seno .....433
gancho para fistulas Emmet.....594	Graefe pinza de diseccion.....83	Halle-Tieck espejulo nasal.....423
gancho para galea Yasargil.....330	Graefe pinza para fijacion.....389	Halsey porta aguja.....208
gancho para iris O'Conner.....375	Graefe pinza para iris.....382	Halsted-Mosquito pinza hemostatica .....105
gancho para iris Wiener.....375	Graefe quistotomo.....375	Hank dilatador uterino.....580
gancho para la piel Cottle.....448	Graeffe tijera para cirugia.....56	Hargis separador para el borde anterior.....463
gancho para la piel Cottle-Neivert.....448	Graham gancho para nervio.....329	Hargis separador para el cuerpo mandibular.....463/6
gancho para la piel Freer.....448	Graig pinza para tabique nasal.....426	Harken pinza auricular.....503
gancho para la piel Gillies.....448	grapa para cuero cabelludo Raney.....327	Harms sonda.....381
gancho para la piel Neivert-Cottle.....448	grapas.....326	Harrington pinza bronquial.....490
gancho para las alas de la nariz Lange.....448	grapas de plata.....326	Harrington separador.....147
gancho para nervio Crile.....328	Grave espejulo vaginal.....570	Harrington-Pemberton separador.....147
gancho para nervio Cushing.....328	Gray pinza hemostatica.....121	Hartmann baja-lengua.....452
gancho para nervio Dandy.....328	Green disecador corneal.....374	Hartmann cateter auricular.....408
gancho para nervio Graham.....329	Green gancho muscular.....375	Hartmann diapason.....403
gancho para nervio Krayenbühl.....336	Green pinza para fijacion.....390	Hartmann espejulo auricular.....399
gancho para nervio Sachs.....329	Green separador.....160	Hartmann espejulo nasal.....422
gancho para nervio Smithwick.....329	Green-Armytage pinza para uterus.....605	Hartmann pinza auricular.....411
gancho para sacar el inserto I.U.D.....593	Green-Langenbeck separador.....153	Hartmann pinza hemostatica.....104
gancho para traqueotomia Bose.....477	Green-Senn separador.....153	Hartmann pinza nasal.....424, 427
gancho para traqueotomia Itersen.....477	Gregoire pinza intestinal.....538	Hartmann pinza para polipos.....412
gancho para traqueotomia Jackson.....476	Gregory pinza atraumatica.....517	Hartmann-Collin separador.....141
gancho para traqueotomia News.....477	Greven pinza auricular micro.....414	Hartmann-Halle espejulo nasal.....421
gancho Reda.....150	Grip alicate.....316	Hartmann-Hoffmann pinza para polipos.....412
gancho Rollet.....375	Grip Kelly separador.....142	Hartmann-Wulstein pinza para polipos.....412
gancho Rosen.....419	Grip Richardson separador.....142	Hasson separador.....143
gancho Shambaugh.....419	Grip-Deaver separador.....146	Haugh pinza auricular micro.....414
gancho Sinskey.....376	Gross cuchara y gancho.....409	Haverfield-Scoville separador para laminectomia.....196
gancho y cuchara Gross.....409	Gross-Maier pinza porta-esponja.....134	Hayes pinza para anastomosis.....545
ganchos.....419	Gruber espejulo auricular.....399	Heaney pinza para histerectomia.....126
garrote de madera Maunder.....459	Gruenwald-Jansen pinza nasal.....424	Heaney porta aguja.....210
Gass gancho.....376	Gruenwald-Love pinza cortante para laminectomia.....340	Heaney separador.....164
Gauss pinza para pericraneio.....605	gubia.....259-265	Heany cureta para biopsia.....587
Gaylor-Thomas pinza para biopsia.....588	gubia Alexander.....259	Heany-Ballentine pinza para histerectomia.....127
Geissendoerfer-Overholt pinza hemostatica.....114	gubia Brünings-Lucas.....260	Heath martillo.....273
Gelpi separador perineal.....189/1, 189/2	gubia Cobb.....262	Heath tijera para ligadura.....66
Gemini pinza hemostatica.....115	gubia Hibbs.....265	Heath-Richter pinza para quitar agrafes.....224
Gerald pinza de diseccion.....86, 87	gubia Lexer.....263	Hebra cucharilla para chalazion.....377
Gerster barra de traccion.....250	gubia Lexer Mini.....263	Hegar dilatador uterino.....578, 579
Gerzog martillo.....270	gubia Lucas-Brünings.....260	Hegar-Conwin pinza para torcer hilo.....319
Gibbon-Bailey aproximador para costillas.....489/1	gubia Mini Lexer.....263	Hegar-Mayo porta aguja.....209
Gierzt-Stille costotomo.....481	gubia para cuerpos extraños Ellis.....374	Hegar-Olsen porta aguja.....212
Gigli mango para sierra hilo.....332	gubia para cuerpos extraños Walton.....374	Hegenbarth pinza para aplicar agrafes.....224
Gill cuchillo corneal.....373	gubia Partsch.....259	Heifetz espátula cerebral.....369
Gill pinza para iris.....384	gubia Petersen-Smith.....261	Heiming pinza para calculos renales.....536
Gill-Arruga pinza capsular.....390	gubia Smith-Petersen.....261	Heiss pinza hemostatica.....112
Gill-Hess pinza para iris.....384	gubia Stille.....260	Heister abre-boca.....454
Gillies gancho para la piel.....448	gubia Zielke.....264	hemostatico.....258, 259
Gillies pinza de diseccion.....86	guia-conductora DeMartel.....330	hemostatico Caspar.....258
Gillies porta aguja.....212	guia-conductora para clavos medulares.....321	Henke elevador para amigdalas.....465
Gil-Vernet separador.....152	Guilen legra de succion.....433/1	Henley separador.....170
Glover clamp atrauma bulldog.....100, 103	Gunar-Hey-Bülöw pinza cierra-tubo.....130	Hennig separador para yesos.....232
Glover pinza para uso multiple.....515	Guthrie gancho.....148/2	Hepp-Scheidel micro tijera.....78
Gluck costotomo.....480	Guyon bujia dilatadora.....554	Hercules alicates para alambres.....320/1-320/3
Goelet separador.....141	Guyon mandril para cateter.....554	Herrick pinza para pediculo.....123
Goldman-Fox tijera para encias.....67	Guyon pinza hemostatica.....122	Hess pinza capsular.....391
Gomel micro tijera.....80	Guyon-Mayo pinza hemostatica.....122	Hess pinza para iris.....384
Gomel pinza para microcirugia.....96	Guyton-Lundsgaard esclerotomo.....373	Hess separador para la raiz de nervios.....329/1
goniometro Moeltgen.....25		Hess-Gill pinza para iris.....384
goniometro para dedos.....25		Hey-Bülöw-Gunar pinza cierra-tubo.....130



Heymann pinza nasal.....	425	instrumento para vendaje enyesado Reda.....	232	juego para varices Nabatoff.....	201
Heymann tijera nasal.....	58	instrumentos para manicura.....	612, 612/1	Juers pinza auricular micro.....	414
Heymann-Knight pinza nasal.....	425	instrumentos para medir.....	594	Jurasz pinza para polipos laringeos.....	471
Heywood-Smith pinza hemorroidal.....	567	instrumentos para traqueotomia.....	475		
Hibbs cincel.....	265	lowa pinza uterina.....	584	<b>K</b>	
Hibbs gubia.....	265	lris tijera para cirugia.....	54/2	Kabierske lanzapolo.....	405
Hibbs osteotomo.....	265	lris tijera supercut.....	72	Kader espátula abdominal.....	143/3
Hibbs separador.....	164	Israel separador.....	162	Kallmorgen especulo vaginal.....	573
Hill-Ferguson especulo rectal.....	560	Iterson gancho para traqueotomia.....	477	Kalt pinza capsular.....	391
hilos para huesos.....	314	lves-Fansler anoscopio.....	562	Kalt porta aguja.....	214
Hirschman espátula para ciclodialisis.....	379	lwanson calibrador decimal.....	624	Kalt-Arruga porta aguja.....	214
Hirschmann anoscopio.....	562			Kane clamp umbilical.....	605
histerometro Collin.....	586	<b>J</b>		Kantrowitz pinza hemostatica.....	119/1
histerometro Martin.....	586	Jackson especulo vaginal.....	573	Kaye tijera face lift.....	73
histerometro Sims.....	586	Jackson gancho para traqueotomia.....	476	Kay-Lambert pinza para anastomosis.....	505
histerometro Valleix.....	586	Jackson laringoscopia.....	37	Kazanjan-Cottle pinza cortante para huesos.....	241
Hoen elevador para duramadre.....	333	Jackson pinza de agarre para tendones.....	292	Kelly Grip separador.....	142
Hoessel porta aguja.....	213	Jackson pinza para tapones.....	471	Kelly pinza hemostatica.....	106
Hofer separador para pilar.....	465	Jackson portador de luz.....	37	Kelly pinza para polipos uterinos.....	585
Hoffmann cierra-tubos.....	624	Jackson separador traqueal.....	476	Kelly proctoscopia.....	562, 563
Hoffmann-Hartmann pinza para polipos.....	412	Jackson-Burrows separador.....	189/2	Kelly separador.....	142, 164
Hoglund-Lowman pinza para huesos.....	249	Jackson-Chevalier canula para traqueotomia.....	479	Kelly tijera vascular.....	61
Hohmann elevador.....	284, 285	Jackson-Chevalier pinza para bronco-esofagoscopia.....	473	Kelly-Rankin pinza hemostatica.....	106
Hohmann mini elevador.....	286	Jacobs pinza uterina.....	583	Kern pinza para hueso.....	244
Hohmann-Lange elevador.....	286	Jacobsen porta aguja.....	215	Kerrison pinza cortante.....	428
hoja de repuesto para dermatomo.....	49, 50	Jacobson cucharilla cortante.....	257	Kerrison-Ferris-Smith pinza sacabocado	
hojas de afeitar.....	45	Jacobson sonda abotonada.....	335	para discos intervertebral.....	344, 344/2
hojas de bisturi, esteril.....	42	Jaeger cuchillo de discision.....	372	Keorkian cureta para biopsia.....	587
hojas de cincel intercambiables.....	266	Jaeger placa para parpado.....	371	Keorkian pinza para biopsia.....	589, 591
hojas de osteotomo intercambiables.....	266	Jameson gancho para estrabismo.....	375	Keorkian-Pacific pinza para biopsia.....	592
Hoke osteotomo.....	265	Jameson pinza para estrabismo.....	385	Keorkian-Tischler pinza para biopsia.....	592
Holinger laringoscopia.....	37	Jansen cucharilla cortante.....	257	Key elevador.....	282
Holinger portador de luz.....	37	Jansen pinza gubia.....	237	Keyes trepano.....	608
Holmgren-Richnau especulo auricular.....	400	Jansen pinza nasal.....	424	Kielland forceps obstetrico.....	602
Holsher separador para la raiz de nervios.....	329/1	Jansen separador.....	168	Kielland-Luikart forceps obstetrico.....	603
Holth pinza para capsuloridectom.....	380	Jansen-Doyen (Molt) abre-boca.....	454	Killian (Eicken) canula irrigacion.....	433
Holzbach pinza para histerectomia.....	126	Jansen-Gruenwald pinza nasal.....	424	Killian canula.....	433/1
Holzheimer separador.....	168	Jansen-Middleton pinza para el tabique nasal.....	430	Killian cincel nasal.....	442/1
Hopkins cuchillo para vendaje enyesado.....	233	Jansen-Zaufal elevador auricular.....	409	Killian elevador para el tabique nasal.....	438, 439
Hopkins-Johns pinza hemostatica.....	120	Jansen-Zaufal pinza gubia.....	238	Killian especulo nasal.....	423
Hopkins-Johns serra-fina.....	104	Jarcho pinza uterina.....	583	Killian tijera para septo.....	471
Horne-Jobson porta-algodon.....	203	Javid pinza para shunt carotido.....	511	Killian-Claus cincel nasal.....	442/1
horquilla fijadora Burch.....	373	Jennings abre-boca.....	454	Kilner gancho cutaneo.....	608
Horsley elevador para duramadre.....	333	Jensen canula capsular.....	394	Kilner porta aguja.....	212
Horsley-Stillé pinza cortante para huesos.....	242	jeringa.....	406, 407, 470	Kilner retractor nasal.....	447/1
Hösel separador.....	167	jeringa auricular Reiner.....	406	Kilner tijera para cirugia.....	54/1
Hospital-Providence pinza hemostatica.....	106	jeringa para amigdalas.....	470	Kilner/Ragnell tijera supercut.....	72
House cureta.....	420	Jobson-Horne porta-algodon.....	203	Kilner-Doughty abre-boca.....	456
House sonda para medir.....	420	Johns-Hopkins pinza hemostatica.....	120	Kirby-Arthur pinza para fijacion.....	385
House tubo de aspiracion.....	337/2	Johns-Hopkins serra-fina.....	104	Kirk martillo.....	270
Howarth elevador para el tabique nasal.....	438	Joll especulo vaginal.....	477, 577	Kirschner alambre.....	306, 307
Huber mango universal.....	472	Joll separador.....	477, 577	Kirschner estribo para extension.....	312
Hudson perforador de mano.....	299	Jones pinza de campo.....	132	Kirschner gancho.....	313
Hulka pinza uterina.....	583	Jones-Clip pinza de campo.....	132	Kirschner perforador de mano.....	299
Humby dermatomo.....	50	Jones-Leland pinza para vasos perifericos.....	495	Kirschner separador abdominal.....	185, 187, 187/1
Hunter pinza para espinas.....	91	Jonson porta aguja.....	211	Kirschner sonda conductora.....	221
Hurd elevador para amigdales.....	465	Jorgensen tijera de discision.....	53	Kirschner soporte de esterilizacion para alambres.....	305
		Joseph (Lewis) lima nasal.....	443	Kirschner U.S. estribo para extension.....	312
<b>I</b>		Joseph bisturi nasal.....	434, 435	Klapp gancho.....	150
I.U.D. gancho para sacar el inserto.....	593	Joseph Cottle elevador para el tabique nasal.....	439	Kleinert-Kutz gancho.....	149
lman ocular Reda.....	395	Joseph elevador para el tabique nasal.....	437	Kleinert-Kutz pinza de agarre para tendones.....	294
impactor final Kuentscher.....	321	Joseph gancho.....	149	Kleinert-Kutz pinza gubia.....	237
impactor/extractor para clavos.....	321-322/1	Joseph lima para hueso.....	443	Kleinsasser anillo.....	36
luge separador para cuerpo vertebral.....	339	Joseph Peck tijera face lift.....	73	Kleinsasser articulacion.....	36
Ingrown instrumento para uña.....	612/1	Joseph periostotomo.....	277	Kleinsasser canula de inyeccion.....	36
InstruCare aceite para instrumentos.....	635	Joseph sierra nasal.....	446	Kleinsasser canula de succion.....	36
instrumento para circuncision.....	556	Joseph tijera para cirugia.....	54/1	Kleinsasser laringoscopia operativo.....	35
instrumento para circuncision Mogen.....	556	Judd-Allis pinza intestinal.....	538	Kleinsasser portador de luz fria.....	36
instrumento para cuerpo extraños Dix.....	380	Judd-Masson separador vesical.....	552	Kleinsasser soporte pectoral.....	36
instrumento para cuerpo extraños LaForce.....	374	juego de laringoscopia Foregger.....	31	Kleinschmidt pinza para apendice.....	544
instrumento para el fragmento de la uña.....	612/1	juego de laringoscopia McIntosh.....	31	Klinikum Berlin pinza cierra-tubo.....	129
instrumento para uña Ingrown.....	612/1	juego de manicura para enfermeras.....	609	Klinkenbergh-Loth tijera vasija.....	65/2
instrumento para varices Varady.....	202	juego de recambio para alicata Hercules.....	320/1-320/3	Knapp cucharilla para cataratas.....	378

Knapp cuchillo para iris.....	372	Lane pinza de diseccion .....	84	lima para uñas.....	610
Knapp gancho.....	375	Lane pinza estomacal .....	547	Lister (Sinus) pinza porta esponja.....	137
Knapp tijera para cirugía.....	55	Lane pinza para hueso.....	244	Lister tijera para vendaje.....	69/1
Knapp-Luer pinza para tracoma.....	393	Lane pinza para sostener placas.....	325	Lister tijera supercut.....	72
Knight pinza nasal.....	425	Lane pinza para sostener tornillos.....	325	Lister-Burch blefarostato.....	370
Knight-Heymann pinza nasal.....	425	Lane Trethowan elevador.....	290	Liston cuchillo para amputacion.....	44
Knowles tijera para vendaje.....	70	Lane-Murphy elevador.....	283	Liston pinza cortante para huesos.....	241
Kocher espátula vesical.....	552	Lang diseccionador para el saco lacrimal.....	378	Liston-Ruskin pinza cortante para huesos.....	241
Kocher pinza hemostatica.....	108	Lange gancho para las alas de la nariz.....	448	Liston-Stille pinza cortante para huesos.....	242
Kocher pinza intestinal.....	540	Lange punta de pinza.....	472	Littauer pinza auricular.....	411
Kocher separador.....	155, 159, 160, 163	Lange-Hohmann elevador.....	286	Littauer pinza depilatoria.....	395
Kocher sonda para bocio.....	479	Langenbeck asa.....	409	Littauer pinza para polipos.....	425
Kocher-Langenbeck separador.....	159	Langenbeck cuchillo para amputacion.....	44	Littauer tijera para ligadura.....	66
Koenig sonda conductora.....	221/1	Langenbeck cuchillo para reseccion.....	47	Little separador.....	157
Koenig-Roser abre-boca.....	454	Langenbeck periototomo.....	275	Littler tijera para cirugía.....	55
Koerte separador.....	162	Langenbeck pinza para hueso.....	243	Littlewood pinza intestinal.....	538
Koerte-Luer cuchara para calculos biliares.....	533	Langenbeck porta aguja.....	213	llave de tuerca.....	313
Kofler-Hajek pinza cortante.....	429	Langenbeck separador.....	158, 159	Locke espátula.....	612/1
Kofler-Hajek pinza sacabocado.....	431	Langenbeck sierra para amputacion.....	296	Lockhart-Mummary sonda para fistula.....	200
Kogan especulo endocervical.....	577	Langenbeck-Green separador.....	153	Locklin tijera para encias.....	69
König elevador.....	284	Langenbeck-Kocher separador.....	159	Lockwood-Allis pinza intestinal.....	538
König periototomo.....	276	Langenbeck-Parker / Us Army separador.....	141	Loktite Collin separador abdominal.....	191
König separador.....	153	lanzapolvo Kabierske.....	405	London-College pinza dental.....	93
Koos micro cuchillo.....	335	laringoscopio Foregger.....	29	Lopez-Reinke elevador para amigdales.....	465
Körte separador.....	143/3	laringoscopio Holinger.....	37	Lorenz tijera para vendaje.....	70
Krause cierra-nudo auricular.....	411	laringoscopio Jackson.....	37	Lorna pinza para campo.....	133
Krause polipotomo.....	433/2	laringoscopio McIntosh.....	29	Loth-Klinkenbergh tijera vasija.....	65/2
Krause punta de pinza.....	472	laringoscopio Miller.....	30	Loute tensor de cierra-hilo.....	315
Krause-Voss polipotomo.....	433/2	laringoscopio operativo Kleinsasser.....	35	Love separador para la raiz de nervios.....	329/2, 330
Krayenbühl gancho para nervios.....	336	Larsen pinza para tendones.....	292	Love separador para uvula.....	465
Kristeller especulo vaginal.....	572	Lawrence pinza hemostatica.....	119	Love-Gruenwald pinza cortante para laminectomia.....	340
Kroenig baja-lengua.....	451	Lebsche cincel de esternon.....	267	Lovelace pinza hemostatica.....	109
Kronecker aguja para ligadura.....	219	Lees pinza bronquial.....	504	Lovelace pinza para coger el pulmon.....	490
Kuentscher impactor final.....	321	legra de succion Guilen.....	433/1	Lower pinza hemostatica.....	120
Kuglen manipulador.....	376	Legueu espátula vesical.....	552	Lowman pinza para huesos.....	249
Kümmel espátula abdominal.....	143/4, 144	Legueu separador vesical.....	553	Lowman-Hoglund pinza para huesos.....	249
Kümmel separador abdominal.....	143/4	Leksell (Stille) pinza gubia.....	240	Lowman-Lambert pinza para huesos.....	249
Küntscher extractor.....	322	Leland-Jones pinza para vasos perifericos.....	495	Lubet-Barbon pinza nasal.....	424
Küntscher perforador para femur.....	321	Lempert cucharilla cortante.....	256	Luc pinza nasal.....	426
Küntscher perforador para la cavidad medular.....	321	Lempert elevador.....	420	Lucae aguja para paracentesis.....	408
Kutz-Kleinert ganchito.....	149	Lempert pinza gubia.....	237	Lucae diapason.....	404
Kutz-Kleinert pinza de agarre para tendones.....	294	Lerche pinza de diseccion.....	83	Lucae gancho abotonado.....	409
Kutz-Kleinert pinza gubia.....	237	Lerliche pinza hemostatica.....	111	Lucae martillo.....	271
		Lerliche separador intestinal.....	143/4	Lucae pinza auricular.....	410
L		Lester pinza para fijacion.....	389	Luer canula para traqueotomia.....	479
L&M separador intra oral.....	463/4	Levinson aguja para cuerpos extraños.....	374	Luer pinza gubia.....	236
Laborde dilatador traqueal.....	476	Lewin pinza para hueso.....	246	Luer separador.....	140
Lacrimal canula.....	394	Lewis (Joseph) lima nasal.....	443	Luer-Knapp pinza para tracoma.....	393
LaForce adenotomo.....	450	Lexer Baby tijera de diseccion.....	53	Luer-Koerte cuchara para calculos biliares.....	533
LaForce instrumento para cuerpos extraños.....	374	Lexer gubia.....	263	Luer-Stille pinza gubia.....	239
LaGrange tijera para encias.....	69	Lexer Mini gubia.....	263	Luikart forceps obstetrico.....	603
LaGrange tijera supercut.....	72	Lexer Mini osteotomo.....	263	Luikart-Bill tractor.....	604
Lahey ganchito.....	149	Lexer osteotomo.....	263	Luikart-Kielland forceps obstetrico.....	603
Lahey pinza hemostatica.....	119/2, 120	Lexer tijera de diseccion.....	53	Luikart-McLean-Tucker forceps obstetrico.....	603/1
Lahey pinza para agarrar el bocio.....	479	Leyla separador de sistema.....	368-368/3	Lundsgaard esclerotomo.....	373
Lahey separador.....	157	lezna Obwegeser.....	463, 463/3	Lundsgaard-Guyton esclerotomo.....	373
Lambert pinza para chalazion.....	393	Lichtenberg porta aguja.....	213	Luniatshchek tamponeador.....	465
Lambert-Kay pinza para anastomosis.....	505	Lichtwitz trocar para seno maxilar.....	204		
Lambert-Lowman pinza para huesos.....	249	Liebermann blefarostato.....	371	M	
Lambotte osteotomo.....	261	ligador para hemorroides.....	568	Magill pinza para introducir cateter.....	28
Lambotte periototomo.....	274	ligador para hemorroides McGivney.....	568	Maier-Gross pinza porta-esponja.....	134
Lambotte pinza para hueso.....	244	ligador para hemorroides Rudd.....	568	Maingot pinza para histerectomia.....	123/1, 123/2
Lambotte-Farabeuf pinza para hueso.....	243	lima nasal Aufrecht.....	443	malla de alambre.....	311
lampara frontal Clar.....	22	lima nasal Cottle (Maltz).....	444	Maltz (Cottle) lima nasal.....	444
lampara halogena.....	29	lima nasal Fomon.....	444, 445	Maltz lima nasal.....	443, 444
Lancaster blefarostato.....	371	lima nasal Joseph (Lewis).....	443	mamaria separador.....	486/1
Landau especulo vaginal.....	577	lima nasal Lewis (Joseph).....	443	mandril.....	300
Landau-Segond pinza para histerectomia.....	125	lima nasal Maltz.....	443, 444	mandril para cateter Guyon.....	554
Landolt pinza para tumores.....	341/2	lima nasal Maltz (Cottle).....	444	mango bisturi Mini.....	41
Lane destornillador.....	323, 324	lima para hueso Joseph.....	443	mango bisturies.....	38-41
Lane elevador.....	290	lima para huesos.....	294, 443-446, 612/1	mango con iluminacion para proctoscopia Morgan.....	565
Lane palanca para doblar placas.....	325	lima para huesos Putti.....	294	mango de acople rapido.....	301
Lane pinza de campo.....	133	lima para seno Gallaher.....	446	mango de aspiracion Wullstein.....	338

mango de bisturi Collin.....40	Mayo-Noble tijera de diseccion.....52/1	Millin pinza para ligadura.....551
mango de pila para laringoscopia.....32-34	Mayo-Robson pinza intestinal.....541	Millin pinza para lobo anterior.....551
mango para cincel/gubia.....266	Mayo-Stille tijera de diseccion.....52/1	Millin separador cuello vejiga.....553
mango para espejo laringeo.....473	Mayo-Stille tijera supercut.....71	Millin separador vesical.....552
mango para sierra hilo Gigli.....332	McCullough pinza para estrabismo.....385	Mini Friedmann pinza gubia.....234
mango universal Huber.....472	McDonald elevador.....283	Mini Hohmann elevador.....286
manguito de cierre Stone-Watt.....545	McGee gancho.....419	Mini mango de bisturi.....41
manguito de cierre Watt-Stone.....545	McGee pinza auricular micro.....414	Mini Roux separador.....140
manipulador Kuglen.....376	McGivney ligador para hemorroides.....568	Mini-Lambotte osteotomo.....262
manometro.....295	McGivney pinza para hemorroides.....568	Minimus II esfigmomanometro.....11
manopla de plomo.....250	McIndoe pinza cortante para huesos.....241	Minimus III esfigmomanometro.....12
marcador Amsler-Connin.....380	McIndoe pinza de diseccion.....85	Mini-Townsend-Down pinza para biopsia.....591
marcador Connin-Amsler.....380	McIndoe tijera para cartilago.....65/1	Mini-Townsend-Up pinza para biopsia.....591
Marquardt pinza gubia.....239	McIntosh juego de laringoscopia.....31	Minnesota-Cawood baja-lengua.....451
Marschik pinza para amigdalas.....468	McIntosh laringoscopia.....29	Mixer Baby pinza hemostatica.....119/1
Martel pinza hemostatica.....110	McIntyre canula lacrimal.....394	Mixer pinza hemostatica.....116, 119/1-120
Martel Willet pinza hemostatica.....110	McIvor abre-boca.....457	Mixer pinza para calculos biliares.....530/2, 531
martillo.....24, 270-273	McKenty elevador para el tabique nasal.....437, 438	Mixer-DeBakey pinza para ligaduras.....499/2
martillo Bergmann.....272	McKenzie pinza aplicadora.....326	Mixer-O'Shaughnessy pinza hemostatica.....119/2
martillo Collin.....270	McLean forceps obstetrico.....603/1	Mixer-Overholt pinza hemostatica.....115
martillo Cottle.....273	McLean-Luikart forceps obstetricos.....603/1	Mod. Bonn pinza para sutura.....386
martillo de percusion Babinsky.....24	McLean-Tucker forceps obstetrico.....603/1	Mod. Muenchen cureta para biopsia.....587
martillo de percusion Berliner.....24	McLean-Tucker-Luikart forceps obstetrico.....603/1	Mod. Tübingen pinza para ligadura.....392
martillo de percusion Buck.....24	McPherson pinza para ligadura.....392	Mod. Tübingen pinza para sutura.....386
martillo de percusion Taylor.....24	Mead martillo.....271	Mod. USA tijera para cordon umbilical.....64
martillo de percusion Troemner.....24	Mead pinza gubia.....235	Mod. Vienna especulo nasal.....421
martillo Gerzog.....270	Meeker pinza hemostatica.....119	Moeftgen goniometro.....25
martillo Hajek.....273	Mehdorn pinza para vasos.....362	Mogen instrumento para circuncision.....556
martillo Heath.....273	Mellinger blefarostato.....370	Mollison separador.....171
martillo Kirk.....270	Mellinger-Axenfeld blefarostato.....370	Molt (Doyen-Jansen) abre-boca.....454
martillo Lucae.....271	Menghini aguja para biopsia.....206	Molt periostotomo.....276
martillo Mead.....271	meniscotomo Neff.....292	mondador de tendones Brand.....294
martillo Ombredanne.....273	meniscotomo Smillie.....292	monoplares pinza.....634
martillo Partsch.....271	Mercedes separador toracico.....489	Moor cuchara para calculos biliares.....531
martillo Quising.....271	Meriam pinza dental.....93	Moore perforador de mano.....298
martillo Williger.....271	Metzenbaum porta aguja.....211	Moore-Staude pinza uterina.....582
Martin histerometro.....586	Metzenbaum tijera de diseccion.....53/1	Moorfield pinza para sutura.....392
Martin pelvometro.....605	Metzenbaum tijera para cirugia.....54	More-Vu especulo vaginal.....569
Martin pinza para cartilago.....246	Metzenbaum tijera supercut.....71	Morgan protoscopia.....565
Martin separador.....175/1	Meyer pinza para aplicar agrafes.....248	Morgan-Tischler pinza para biopsia.....590, 591
Martin-Cartilage tijera.....65/1	Meyer-Davis abre-boca.....457	Moritz-Schmidt baja-lengua.....452
Martini cucharilla cortante.....257	Meyerding separador.....157, 177, 180	Morris separador.....164
Masing elevador.....437	Meyhoefer cucharilla para chalazion.....377	Morris-DeBakey pinza para la aorta.....506
Masing elevador para tabique nasal.....437	Michel agrafe.....224	Morse separador costal.....484
Masing retractor nasal.....447	Michel espejo laringeo.....423	Morse-Favaloro separador costal.....484
Masing-Neivert retractor nasal.....447	Michel pinza para aplicar agrafes.....224	Mosher-Wagener canula para traqueotomia.....477
Masson porta aguja.....210	Michel pinza para aplicar y quitar agrafes.....224	Mosquito-DeBakey pinza hemostatica.....509
Masson-Judd separador vesical.....552	micro cuchillo Koos.....335	Mosquito-Halsted pinza hemostatica.....105
Mastin pinza muscular.....479	Micro Friedmann pinza gubia.....234	Moynihan explorador apra calculos biliares.....531
Mathieu especulo rectal.....560	micro pinza.....86, 94	Moynihan pinza de campo.....133
Mathieu pinza para cuerpos extraños.....553/1	micro pinza auricular.....413-415	Moynihan pinza hemostatica.....120
Mathieu porta aguja.....213	micro porta aguja Barraquer.....216, 217	Mueller blierarostato.....371
Mathieu separador.....141	micro porta aguja Barraquer-Trountman.....216	Muenchen Mod. cureta para biopsia.....587
Mathieu-Olsen porta aguja.....212	micro porta aguja Castroviejo-Standard.....216	Müller aproximador.....364
Matson periostotomo.....279	micro porta aguja Standard-Castroviejo.....216	Müller clip para vasos.....365
Matson-Alexander periostotomo.....279	micro porta aguja Troutman-Barraquer.....216	Müller-Verbrugge elevador.....286/2
Mauder garrote de madera.....459	micro tijera.....76-78	Mummery-Lockhart sonda para fistula.....200
Maxi Grasper pinza para biopsia.....593	micro tijera Circumflex.....76	Murdoch blefarostato.....370
May oftalmoscopio Uni II.....14	micro tijera Gomel.....80	Murphy separador.....156
Mayfield pinza gubia.....238	micro tijera Hepp-Scheidel.....78	Murphy-Lane elevador.....283
Mayo baja-lengua.....451	micro tijera Reda.....77, 80	Murray-Crile porta aguja.....209
Mayo clip para esterilizacion.....227, 624	micro tijera Scheidel-Hepp.....78	Museux pinza uterina.....583
Mayo cuchara para calculos biliares.....534	Micro-Castroviejo porta aguja.....215	Myles pinza nasal.....427
Mayo pinza de diseccion.....89	Microvascular porta aguja.....210	
Mayo sonda para calculos biliares.....534	Middeldorf separador.....160	N
Mayo tijera de diseccion.....52/1	Middleton-Jansen pinza para el tabique nasal.....430	Nabatoff juego para varices.....201
Mayo tijera supercut.....71	Mikulicz pinza intestinal.....543	Naegele forceps obstetrico.....603
Mayo-Adams separador.....171	Mikulicz pinza para peritoneo.....123	Nager aguja para sutura del paladar.....466
Mayo-Blake pinza para calculos biliares.....530/2	Mikulicz separador.....163	Nager separador para paladar.....465
Mayo-Collins separador.....141	Miller laringoscopia.....30	Nasalis-Spina separador para el ramo.....461
Mayo-Guyon pinza hemostatica.....122	Miller-Senn separador.....143	navaja.....49
Mayo-Haberisser pinza para torcer hilo.....319	Milligan elevador para duramadre.....332	Neff meniscotomo.....292
Mayo-Hegar porta aguja.....209	Millin pinza de agarre para capsula.....550, 551	Negus pinza para coger amigdalas.....467

Negus soporte de pecho.....	459	Overholt-Baby pinza hemostatica.....	114	periotostomo Matson-Alexander.....	279
Neivert porta aguja.....	208	Overholt-Geissendoerfer pinza hemostatica.....	114	periotostomo Molt.....	276
Neivert-Anderson cincel nasal.....	442	Overholt-Mixer pinza hemostatica.....	115	periotostomo Obwegeser.....	462
Neivert-Cottle gancho para la piel.....	448			periotostomo Quervain.....	275
Neivert-Masing retractor nasal.....	447	P		periotostomo Sebleau.....	275
Nelaton sonda.....	199	Pacific-Kevorkian pinza para biopsia.....	592	periotostomo Sedillot.....	274, 275
Nelson (Standard) trocar abdominal.....	204	palanca para doblar placas Lane.....	325	periotostomo Seldin.....	277
Nelson aguja para ligadura.....	219	Palmer-Pozzi pinza uterina.....	582	periotostomo Semb.....	278
Nelson pinza de diseccion.....	89	Park blierarostato.....	371	periotostomo Williger.....	276
Nelson trocar.....	205	Parker separador.....	139	Perkins separador.....	168
Neonatal pinza vascular.....	523	Parker-Langenbeck / Us Army separador.....	141	Perthes escariador.....	304
News gancho para traqueotomia.....	477	Partsch cincel.....	259	Pestalozza cureta para aborto.....	606
Nissen pinza hemostatica.....	113	Partsch gubia.....	259	Petersen-Smith cincel.....	261
Noble-Mayo tijera de diseccion.....	52/1	Partsch martillo.....	271	Petersen-Smith gubia.....	261
Norfolk / Norwich separador.....	172	pasador de tendones Bunell.....	294	Petersen-Smith pinza gubia.....	238
Northent tijera.....	66	Passow cincel tamponador para huesos.....	260	Petri cubeta.....	620
Norwich / Norfolk separador.....	172	Patella pinza para hueso.....	248	Phaneuf pinza para peritoneo.....	123
Noto pinza para polipos uterinos.....	585	Paton disecador corneal.....	373	Pierce elevador para el tabique nasal.....	438
Nova esfingomanometro.....	7	Paufique cuchillo para queratoplastica.....	373	Pierce trocar para seno maxilar.....	204
Novak cureta aspiradora para biopsia uterina.....	587	Paufique pinza para ligadura.....	392	pieza de acomplamiento para cureta aspiradoras.....	600
Nova-Presameter esfingomanometro.....	6	Payr pinza intestinal y estomacal.....	548	Piffard cureta para lupus.....	608
Noyes pinza para polipos.....	425	Payr sonda conductora.....	221/1	Pinard estetoscopio.....	23
Noyes tijera para iris.....	75	Payr-Baby pinza intestinal y estomacal.....	548	pinza aplicadora.....	104
O		Payr-Schmieden sonda conductora.....	221	pinza aplicadora de clips.....	524, 525
Obwegeser elevador.....	461/1	Pean pinza hemostatica.....	108, 110	pinza aplicadora McKenzie.....	326
Obwegeser gancho de menton.....	461/1	Pean-DeBakey pinza hemostatica atraumatica.....	513	pinza aplicadora Olivecrona-Toennis.....	326
Obwegeser lezna.....	463, 463/3	Pean-Rochester pinza hemostatica.....	108	pinza aplicadora Raney.....	327
Obwegeser osteotomo.....	463	Peapod pinza cortante para laminectomia.....	341/1	pinza aplicadora Smithwick.....	326
Obwegeser osteotomo de hoja.....	464/1	Peck Joseph tijera face lift.....	73	pinza aplicadora Sweet.....	326
Obwegeser periotostomo.....	462	Pederson espejulo vaginal.....	570	pinza aplicadora Toennis-Olivecrona.....	326
Obwegeser separador manibular.....	461/1	Peers pinza de campo.....	132	pinza traumatica Cooley.....	99
Obwegeser separador para partes blandas.....	460	Peet escofina nasal.....	446	pinza traumatica DeBakey.....	98, 99
Ochsner pinza de diseccion.....	88	Peet pinza para espinas.....	92	pinza traumatica Gregory.....	517
Ochsner trocar.....	205	Peikmann pinza porta esponja.....	137	pinza traumatica Reda.....	111
Ochsner-Rochester pinza hemostatica.....	108	pelvimetro Collier.....	605	pinza traumatica Rogers.....	127
O'Conner gancho para iris.....	375	pelvimetro Collin.....	605	pinza auricular Harken.....	503
O'Conner-O'Sullivan espejulo vaginal.....	576	pelvimetro Martin.....	605	pinza auricular Hartmann.....	411
O'Conner-O'Sullivan separador abdominal.....	181	Pemberton-Harrington separador.....	147	pinza auricular Littauer.....	411
Oehler pinza de diseccion.....	81/1	Penfield elevador para duramadre.....	333	pinza auricular Lucae.....	411
oftalmoscopio May Uni II.....	14	Pennington elevador para el tabique nasal.....	438	pinza auricular micro.....	413-415
Oldberg pinza cortante para laminectomia.....	341/1	Pennington pinza hemostatica.....	109	pinza auricular micro Cos.....	414
oliva auricular.....	406	Percy retractor para amputacion.....	296	pinza auricular micro Dieter.....	414
oliva auricular Politzer.....	406	perforacraqueo Smellie.....	607	pinza auricular micro Greven.....	414
Olivecrona elevador para duramadre.....	332	perforador de mano.....	298-300, 304	pinza auricular micro Haugh.....	414
Olivecrona espátula cerebral.....	336	perforador de mano Bunell.....	299	pinza auricular micro Juers.....	414
Olivecrona pinza gubia.....	237	perforador de mano Hudson.....	299	pinza auricular micro McGee.....	414
Olivecrona sierra hilo.....	332	perforador de mano Kirschner.....	299	pinza auricular micro Wullstein.....	416
Olivecrona-Toennis pinza aplicadora.....	326	perforador de mano Moore.....	298	pinza auricular Tilley.....	411
Ollier separador.....	162	perforador de mano Stille.....	300	pinza auricular Troeltsch (Wilde).....	410
Olsen-Hegar porta aguja.....	212	perforador de mano Reda.....	300	pinza auricular Wilde (Troeltsch).....	410
Olsen-Mathieu porta aguja.....	212	perforador de mano Sherman-Stille.....	298	pinza autocentradora para sostener huesos Reda.....	247
Ombredanne martillo.....	273	perforador de mano Stille.....	298	pinza bronquial.....	126
O'Shaughnessy-Mixer pinza hemostatica.....	119/2	perforador de mano Stille-Sherman.....	298	pinza bronquial Finochietto.....	490
osteotomo.....	259-267, 464	perforador inicial Crutchfield.....	327	pinza bronquial Harrington.....	490
osteotomo de hoja Obwegeser.....	464/1	perforador medular.....	322	pinza bronquial Lees.....	504
osteotomo Epker.....	464/2	perforador para femur Kuntscher.....	321	pinza bronquial Price-Thomas.....	490
osteotomo Hibbs.....	265	perforador para la cavidad medular Kuntscher.....	321	pinza bronquial Semb.....	491
osteotomo Hoke.....	265	periotostomo.....	274-280, 463-464	pinza bronquial Thomas-Price.....	490
osteotomo Lambotte.....	261	periotostomo Alexander.....	276	pinza capsular Arruga.....	391
osteotomo Lambotte-Mini.....	262	periotostomo Alexander-Matson.....	279	pinza capsular Arruga-Gill.....	390
osteotomo Lexer.....	263	periotostomo Cobb.....	280	pinza capsular Castroviejo.....	391
osteotomo Lexer Mini.....	263	periotostomo Collin-Farabeuf.....	274	pinza capsular Elschmig.....	391
osteotomo Mini Lexner.....	263	periotostomo Dingman.....	463	pinza capsular Fuchs.....	391
osteotomo Mini-Lambotte.....	262	periotostomo Doyen.....	278	pinza capsular Gill-Arruga.....	390
osteotomo Obwegeser.....	463	periotostomo Farabeuf.....	274	pinza capsular Hess.....	391
osteotomo Stille.....	260	periotostomo Farabeuf-Collin.....	274	pinza capsular Kalt.....	391
Ostroem pinza sacabocado.....	430	periotostomo Fomon.....	277	pinza capsular Schweigger.....	391
O'Sullivan-O' Connor espejulo vaginal.....	576	periotostomo Hargis.....	463/2	pinza capsular Terson.....	391
O'Sullivan-O' Connor separador abdominal.....	181	periotostomo Joseph.....	277	pinza tierra-tubo.....	129, 130
Otis uretrotomo.....	553	periotostomo König.....	276	pinza tierra-tubo Berlin Klinikum.....	129
otoscopio Uni I.....	13	periotostomo Lambotte.....	274	pinza tierra-tubo Bülow-Gunar-Hey.....	130
Overholt pinza hemostatica.....	114	periotostomo Langenbeck.....	275	pinza tierra-tubo Gunar-Hey-Bülow.....	130
		periotostomo Matson.....	279	pinza tierra-tubo Hey-Bülow-Gunar.....	130

pinza cierra-tubo Klinikum Berlin .....	129	pinza de diseccion Duehrsen .....	84	pinza gubia Ruskin-Stille .....	239
pinza cierra-tubo Presbyterian .....	129	pinza de diseccion Durante .....	88	pinza gubia Sauerbruch .....	240
pinza circular .....	432	pinza de diseccion Duval .....	85	pinza gubia Scagletti .....	240
pinza cortante Hajek-Kofler .....	429	pinza de diseccion Duval-Collin .....	85	pinza gubia Semb .....	240
pinza cortante Kerrison .....	428	pinza de diseccion Ferris-Smith .....	85	pinza gubia Smith-Petersen .....	238
pinza cortante Kofler-Hajek .....	429	pinza de diseccion Gerald .....	86, 87	pinza gubia Stellbrink .....	234
pinza cortante para hipofisis .....	341	pinza de diseccion Gillies .....	86	pinza gubia Stille (Leksell) .....	240
pinza cortante para huesos Böhler .....	241	pinza de diseccion Graefe .....	83	pinza gubia Stille-Luer .....	239
pinza cortante para huesos Cottle-Kazanjian .....	241	pinza de diseccion Lane .....	84	pinza gubia Stille-Ruskin .....	239
pinza cortante para huesos Horsley-Stille .....	242	pinza de diseccion Lerche .....	83	pinza gubia Zaufal-Jansen .....	238
pinza cortante para huesos Kazanjian-Cottle .....	241	pinza de diseccion Mayo .....	89	pinza hemorroidal Heywood-Smith .....	567
pinza cortante para huesos Liston .....	241	pinza de diseccion McIndoe .....	85	pinza hemorroidal Smith-Heywood .....	567
pinza cortante para huesos Liston-Ruskin .....	241	pinza de diseccion modelo ruso .....	85	pinza hemostatica Adson .....	112, 113
pinza cortante para huesos Liston-Stille .....	242	pinza de diseccion modelo Strassburger .....	89	pinza hemostatica Adson Baby .....	113
pinza cortante para huesos McIndoe .....	241	pinza de diseccion Nelson .....	89	pinza hemostatica atraumatica DeBakey-Mosquito .....	509
pinza cortante para huesos Ruskin-Liston .....	241	pinza de diseccion Ochsmner .....	88	pinza hemostatica atraumatica DeBakey-Pean .....	513
pinza cortante para huesos Semb .....	242	pinza de diseccion Oehler .....	81/1	pinza hemostatica atraumatica DeBakey-Rankin .....	512
pinza cortante para huesos Stamm .....	241	pinza de diseccion Potts-Smith .....	81, 81/1	pinza hemostatica atraumatica Mosquito-DeBakey .....	509
pinza cortante para huesos Stille-Horsley .....	242	pinza de diseccion Serchen .....	86	pinza hemostatica atraumatica Pean-DeBakey .....	513
pinza cortante para huesos Stille-Liston .....	242	pinza de diseccion Singley .....	88	pinza hemostatica atraumatica Rankin-DeBakey .....	512
pinza cortante para laminectomia Cloward .....	342	pinza de diseccion Smith-Ferris .....	85	pinza hemostatica Baby Adson .....	113
pinza cortante para laminectomia Cushing .....	340	pinza de diseccion Smith-Potts .....	81, 81/1	pinza hemostatica Baby Mixer .....	119/1
pinza cortante para laminectomia Decker .....	341	pinza de diseccion Standard .....	81, 81/1	pinza hemostatica Baby-Overholt .....	114
pinza cortante para laminectomia Ferris-Smith .....	343	pinza de diseccion Stille .....	81, 81/1	pinza hemostatica Bainbridge .....	119/2
pinza cortante para laminectomia Gruenwald-Love .....	340	pinza de diseccion Stille-Barraya .....	88	pinza hemostatica Bengolea .....	112
pinza cortante para laminectomia Love-Gruenwald .....	340	pinza de diseccion Taylor .....	87	pinza hemostatica Birkett .....	116
pinza cortante para laminectomia Oldberg .....	341/1	pinza de diseccion Taylor-Cushing .....	87	pinza hemostatica Bridge .....	116
pinza cortante para laminectomia Peapod .....	341/1	pinza de diseccion USA .....	81, 81/1	pinza hemostatica Carmalt-Rochester .....	109
pinza cortante para laminectomia Schlesinger .....	342	pinza de diseccion Wagensteen .....	89	pinza hemostatica Chaput .....	110
pinza cortante para laminectomia Smith-Ferris .....	343	pinza de diseccion Waugh .....	83	pinza hemostatica Collier-Crile .....	106
pinza cortante para laminectomia Spurling .....	340	pinza de proteccion Adson .....	298	pinza hemostatica Collin .....	110
pinza cortante para laminectomia Wagner .....	343	pinza de reduction Reda .....	247	pinza hemostatica Crafoord .....	118
pinza cuticular .....	610	pinza de relojero .....	90	pinza hemostatica Crafoord-Sellors .....	119
pinza de agarre .....	305	pinza de rodillos .....	131	pinza hemostatica Crile .....	107
pinza de agarre para capsula Milin .....	292-294, 550, 551	pinza de traccion craneal Crutchfield .....	327	pinza hemostatica Crile-Collier .....	106
pinza de agarre para prostata Young .....	550	pinza dental College-London .....	93	pinza hemostatica Crile-Rankin .....	107
pinza de agarre para tendones .....	292, 293	pinza dental London-College .....	93	pinza hemostatica Dandy .....	109
pinza de agarre para tendones Brand .....	293	pinza dental Meriam .....	93	pinza hemostatica Desjardins .....	121
pinza de agarre para tendones Carroll .....	293	pinza depiladora Barraquer .....	395	pinza hemostatica Fergusson .....	109
pinza de agarre para tendones Jackson .....	292	pinza depiladora Beer .....	395	pinza hemostatica Fuchsig .....	113
pinza de agarre para tendones Kleinert-Kutz .....	294	pinza depiladora Douglas .....	395	pinza hemostatica Geissendoerfer-Overholt .....	114
pinza de agarre para tendones Kutz-Kleinert .....	294	pinza depiladora Gradle .....	395	pinza hemostatica Gemini .....	115
pinza de agarre para tendones Steinmann .....	292	pinza depiladora Littauer .....	395	pinza hemostatica Gray .....	121
pinza de aplicacion .....	357-360	pinza depiladora Reda .....	395	pinza hemostatica Guyon .....	122
pinza de campo .....	132, 133	pinza estomacal Lane .....	547	pinza hemostatica Guyon-Mayo .....	122
pinza de campo Backhaus .....	132	pinza gubia Adson .....	236	pinza hemostatica Halsted-Mosquito .....	105
pinza de campo Backhaus-Clip .....	132	pinza gubia Bane-Hartmann .....	237	pinza hemostatica Hartmann .....	104
pinza de campo Bernhard .....	133	pinza gubia Beyer .....	237, 238	pinza hemostatica Heiss .....	112
pinza de campo Clip-Backhaus .....	132	pinza gubia Blumenthal .....	236	pinza hemostatica Hopkins-Johns .....	120
pinza de campo Clip-Jones .....	132	pinza gubia Böhler .....	238	pinza hemostatica Hospital-Providence .....	106
pinza de campo Doyen .....	133	pinza gubia Cleveland .....	235	pinza hemostatica Johns-Hopkins .....	120
pinza de campo Jones .....	132	pinza gubia Echlin .....	240	pinza hemostatica Kantrowitz .....	119/1
pinza de campo Jones-Clip .....	132	pinza gubia Friedmann .....	234	pinza hemostatica Kelly .....	106
pinza de campo Lane .....	133	pinza gubia Friedmann Micro .....	234	pinza hemostatica Kelly-Rankin .....	106
pinza de campo Moynihan .....	133	pinza gubia Friedmann Mini .....	234	pinza hemostatica Kocher .....	108
pinza de campo Peers .....	132	pinza gubia Frykholm .....	240	pinza hemostatica Lahey .....	119/2, 120
pinza de campo Roeder .....	132	pinza gubia Hartmann-Bane .....	237	pinza hemostatica Lawrence .....	119
pinza de campo Schaedel .....	132	pinza gubia Jansen .....	237	pinza hemostatica Leriche .....	111
pinza de campo Tohoku .....	132	pinza gubia Jansen-Zaufal .....	238	pinza hemostatica Lovelace .....	109
pinza de diseccion .....	81-89	pinza gubia Kleinert-Kutz .....	237	pinza hemostatica Lower .....	120
pinza de diseccion Adlerkreutz .....	84	pinza gubia Kutz-Kleinert .....	237	pinza hemostatica Martel .....	110
pinza de diseccion Adson .....	81/2, 82	pinza gubia Leksell (Stille) .....	240	pinza hemostatica Martel Willet .....	110
pinza de diseccion Adson-Brown .....	82	pinza gubia Lempert .....	237	pinza hemostatica Mayo-Guyon .....	122
pinza de diseccion Adson-DeBakey .....	81/2	pinza gubia Luer .....	236	pinza hemostatica Meeker .....	119
pinza de diseccion Barraya-Stille .....	88	pinza gubia Luer-Stille .....	239	pinza hemostatica Mixer .....	116, 119/1-120
pinza de diseccion Bonney .....	88	pinza gubia Marquardt .....	239	pinza hemostatica Mixer Baby .....	119/1
pinza de diseccion Brophy .....	84	pinza gubia Mayfield .....	238	pinza hemostatica Mixer-O'Shaughnessy .....	119/2
pinza de diseccion Brown .....	83	pinza gubia Mead .....	235	pinza hemostatica Mixer-Overholt .....	115
pinza de diseccion Brown-Adson .....	82	pinza gubia Micro Friedmann .....	234	pinza hemostatica Mosquito-Halsted .....	105
pinza de diseccion Collin-Duval .....	85	pinza gubia Mini Friedmann .....	234	pinza hemostatica Moynihan .....	120
pinza de diseccion Cushing .....	83	pinza gubia Olivecrona .....	237	pinza hemostatica Nissen .....	113
pinza de diseccion Cushing-Taylor .....	87	pinza gubia Petersen-Smith .....	238	pinza hemostatica Ochsmner-Rochester .....	108
pinza de diseccion DeBakey-Adson .....	81/2	pinza gubia Ruskin .....	239	pinza hemostatica O'Shaughnessy-Mixer .....	119/2



pinza hemostatica Overholt .....	114	pinza nasal Jansen .....	424	pinza para biopsia Townsend.....	591
pinza hemostatica Overholt-Baby.....	114	pinza nasal Jansen-Gruenwald .....	424	pinza para biopsia Townsend-Down-Mini.....	591
pinza hemostatica Overholt-Geissendoerfer.....	114	pinza nasal Knight .....	425	pinza para biopsia Townsend-Up-Mini .....	591
pinza hemostatica Overholt-Mixter .....	115	pinza nasal Knight-Heymann .....	425	pinza para biopsia Turrel .....	567
pinza hemostatica Pean.....	108, 110	pinza nasal Lubet-Barbon .....	424	pinza para biopsia Up-Mini-Townsend .....	591
pinza hemostatica Pean-Rochester .....	108	pinza nasal Luc .....	426	pinza para biopsia Up-Tischler .....	591
pinza hemostatica Pennington .....	109	pinza nasal Myles.....	427	pinza para biopsia Van Doren .....	588
pinza hemostatica Pratt .....	110	pinza nasal Schmeden .....	427	pinza para biopsia Wittner .....	589
pinza hemostatica Providence-Hospital .....	106	pinza nasal Struycken .....	427	pinza para biopsia Yeoman .....	566, 567
pinza hemostatica Rankin-Crile .....	107	pinza nasal Takahashi .....	427	pinza para bronco-esofagoscopia Chevalier-Jackson .....	473
pinza hemostatica Rankin-Kelly .....	106	pinza nasal Troeltsch .....	424	pinza para bronco-esofagoscopia Jackson-Chevalier .....	473
pinza hemostatica Roberts .....	117	pinza nasal Watson-Williams.....	428	pinza para calculos biliares Blake .....	530/2
pinza hemostatica Rochester-Carmalt.....	109	pinza nasal Weil-Blakesley .....	426	pinza para calculos biliares Blake-Mayo .....	530/2
pinza hemostatica Rochester-Ochsner .....	108	pinza nasal Westmacott .....	424	pinza para calculos biliares Desjardins .....	530/2
pinza hemostatica Rochester-Pean .....	108	pinza nasal Williams-Watson.....	428	pinza para calculos biliares Mayo-Blake .....	530/2
pinza hemostatica Rumel.....	117	pinza para aborto Saenger .....	606	pinza para calculos biliares Mixter.....	530/2
pinza hemostatica Sarot.....	118	pinza para aborto Winter.....	606	pinza para calculos renales Heiming .....	536
pinza hemostatica Sellors-Crafoord.....	119	pinza para agarrar el bocio Lahey.....	479	pinza para calculos renales Randall .....	535
pinza hemostatica Spencer-Wells .....	109	pinza para amigdalas Marschik .....	468	pinza para cambiar hojas .....	179
pinza hemostatica Stille .....	122	pinza para anastomosis Beck .....	516, 520	pinza para campo Ball and Socket .....	133
pinza hemostatica Toennis .....	117	pinza para anastomosis Cooley .....	519-520/4	pinza para campo Lorna .....	133
pinza hemostatica Tuffier .....	110	pinza nasal Weil-Blakesley .....	426	pinza para campo Socket and Ball.....	133
pinza hemostatica Wells-Spencer .....	109	pinza para anastomosis DeBakey.....	505, 515	pinza para capsuloridectom Holth .....	380
pinza hemostatica Wikstroem .....	117	pinza para anastomosis DeMartel-Wolfson .....	546	pinza para cartilagos Martin .....	246
pinza hemostatica Willet Martel .....	110	pinza para anastomosis Derra .....	515	pinza para cateter Cooley .....	510
pinza hemostatica Zenker .....	118	pinza para anastomosis Derra-Cooley.....	519	pinza para cerrar clamps DeMartel-Wolfson .....	546
pinza intestinal Adair-Allis .....	537	pinza para anastomosis Hayes .....	545	pinza para cerrar clamps Stone .....	545
pinza intestinal Allis .....	537	pinza para anastomosis Kay-Lambert .....	505	pinza para cerrar clamps Wolfson-DeMartel .....	546
pinza intestinal Allis-Adair .....	537	pinza para anastomosis Lambert-Kay .....	505	pinza para chalazion Desmarres .....	393
pinza intestinal Allis-Baby .....	537	pinza para anastomosis Potts .....	493	pinza para chalazion Lambert .....	393
pinza intestinal Allis-Boys .....	538	pinza para anastomosis Wolfson-DeMartel .....	546	pinza para coartacion Potts .....	492
pinza intestinal Allis-Judd .....	538	pinza para aneurisma Bahnsen-DeBakey.....	506	pinza para coger amigdalas Abraham .....	468
pinza intestinal Allis-Lockwood .....	538	pinza para aneurisma de la aorta DeBakey.....	496-498	pinza para coger amigdalas Ballenger .....	467
pinza intestinal Allis-Thoms .....	538	pinza para aneurisma DeBakey-Bahnsen .....	506	pinza para coger amigdalas Blohmke.....	467
pinza intestinal Babcock .....	539	pinza para aorta Cooley.....	520/3	pinza para coger amigdalas Colver .....	467
pinza intestinal Baby-Allis .....	537	pinza para apendice Allen .....	544	pinza para coger amigdalas Negus .....	467
pinza intestinal Baby-Doyen .....	540	pinza para apendice Kleinschmidt .....	544	pinza para coger amigdalas Sawtell .....	467
pinza intestinal Baby-Kocher .....	540	pinza para aplicar agrafes Childe .....	224	pinza para coger amigdalas Schmidt .....	467
pinza intestinal Boys-Allis .....	538	pinza para aplicar agrafes Hegenbarth .....	224	pinza para coger amigdalas Tyding .....	468
pinza intestinal Brunner .....	543	pinza para aplicar agrafes Michel .....	224	pinza para coger amigdalas White .....	467
pinza intestinal Doyen .....	540	pinza para aplicar agrafes Wachenfeldt .....	224	pinza para coger el pulmon Lovelace .....	490
pinza intestinal Doyen-Baby .....	540	pinza para aplicar y quitar agrafes Michel.....	224	pinza para columna Cottle .....	448
pinza intestinal Fehland .....	542	pinza para arrancar uñas Radolf .....	297	pinza para cordon espermatico .....	553/2
pinza intestinal Gregoire .....	538	pinza para arrancar vendaje enyesado Wolff.....	233	pinza para cuerpos extraños Mathieu .....	553/1
pinza intestinal Judd-Allis .....	538	pinza para biopsia Alexander .....	589	pinza para desechos Sauerbruch .....	227
pinza intestinal Kocher .....	540	pinza para biopsia Baby Burke .....	590	pinza para el pene Stockmann .....	553/1
pinza intestinal Kocher-Baby .....	540	pinza para biopsia Baby-Tischler .....	592	pinza para el pene Strauss .....	553/1
pinza intestinal Littlewood .....	538	pinza para biopsia Burke .....	590	pinza para el tunel del tendon .....	293
pinza intestinal Lockwood-Allis .....	538	pinza para biopsia Burke Baby .....	590	pinza para el utero Collin .....	585
pinza intestinal Mayo-Robson .....	541	pinza para biopsia Down-Mini-Townsend.....	591	pinza para el utero Dartigues .....	585
pinza intestinal Mikulicz .....	543	pinza para biopsia Down-Tischler .....	591	pinza para el utero Somer .....	585
pinza intestinal Resano .....	542	pinza para biopsia Eppendorfer .....	590	pinza para enderezar el tabique nasal Asch .....	449
pinza intestinal Robson-Mayo.....	541	pinza para biopsia Faure .....	588	pinza para enderezar el tabique nasal Walsham .....	449
pinza intestinal Scudder .....	541	pinza para biopsia Gaylor-Thomas .....	588	pinza para espinas .....	91, 92
pinza intestinal Stone-Watt .....	545	pinza para biopsia Grasper Maxi .....	593	pinza para espinas Archer.....	92
pinza intestinal Thoms-Allis .....	538	pinza para biopsia Grasper Serpentine .....	593	pinza para espinas Carmalt.....	91
pinza intestinal Watt-Stone .....	545	pinza para biopsia Kevorkian .....	589, 591	pinza para espinas Feilchenfeld .....	91
pinza intestinal y estomacal Baby-Payr.....	548	pinza para biopsia Kevorkian-Pacific .....	592	pinza para espinas Hunter .....	91
pinza intestinal y estomacal Payr.....	548	pinza para biopsia Kevorkian-Tischler .....	592	pinza para espinas Peet.....	92
pinza intestinal y estomacal Payr-Baby .....	548	pinza para biopsia Maxi Grasper .....	593	pinza para espinas Stieglitz .....	92
pinza maleolar .....	247	pinza para biopsia Mini-Townsend-Down.....	591	pinza para esterilizacion .....	227
pinza monopolares .....	634	pinza para biopsia Mini-Townsend-Up .....	591	pinza para esterilizacion Cheatle .....	227
pinza muscular Berke .....	389	pinza para biopsia Morgan-Tischler .....	590, 591	pinza para esterilizacion de jeringas Davis .....	227
pinza muscular Mastin .....	479	pinza para biopsia Pacific-Kevorkian .....	592	pinza para esterilizacion Rogge .....	227
pinza muscular Prince .....	386	pinza para biopsia Schubert .....	588	pinza para esterilizacion Universal .....	227
pinza muscular Snellen .....	393	pinza para biopsia Schumacher .....	588, 589	pinza para estrabismo Bonaccolto .....	385
pinza nasal Barbon-Lubet .....	424	pinza para biopsia Serpentine Grasper .....	593	pinza para estrabismo Dastoor .....	386
pinza nasal Blakesley-Weil .....	426	pinza para biopsia Thomas-Gaylor .....	588	pinza para estrabismo Jameson .....	385
pinza nasal Bruenings .....	425	pinza para biopsia Tischler-Baby .....	592	pinza para estrabismo McCullough .....	385
pinza nasal Gruenwald-Jansen .....	424	pinza para biopsia Tischler-Down .....	591	pinza para fijacion Arthur-Kirby .....	385
pinza nasal Hartmann .....	424, 427	pinza para biopsia Tischler-Kevorkian .....	592	pinza para fijacion Barraquer .....	390
pinza nasal Heymann .....	425	pinza para biopsia Tischler-Morgan .....	590, 591	pinza para fijacion Castroviejo .....	390
pinza nasal Heymann-Knight .....	425	pinza para biopsia Tischler-Up .....	591	pinza para fijacion Cottle .....	410

pinza para fijacion Elschmig.....	389	pinza para ligadura Ayer.....	393	pinza para tracoma Knapp-Luer.....	393
pinza para fijacion Graefe.....	389	pinza para ligadura DeBakey.....	493, 499-500	pinza para tracoma Luer-Knapp.....	393
pinza para fijacion Green.....	390	pinza para ligadura McPherson.....	392	pinza para tumores Landolt.....	341/2
pinza para fijacion Kirby-Arthur.....	385	pinza para ligadura Millin.....	551	pinza para tumores Yasargil.....	97
pinza para fijacion Lester.....	389	pinza para ligadura Mod. Tübingen.....	392	pinza para uso multiple Glover.....	515
pinza para hemorroides McGivney.....	568	pinza para ligadura Paufigue.....	392	pinza para uterus Armytage-Green.....	605
pinza para hipofisis Adson.....	334	pinza para ligadura Tübingen Mod.....	392	pinza para uterus Green-Armytage.....	605
pinza para histerectomia Ballentine-Heany.....	127	pinza para ligadura y la aorta DeBakey-Semb.....	499	pinza para vasectomia.....	553/2
pinza para histerectomia Cullen-Wertheim.....	125	pinza para ligadura y la aorta Semb-DeBakey.....	499	pinza para vasos Biemer.....	361
pinza para histerectomia Heaney.....	126	pinza para ligaduras DeBakey-Mixer.....	499/2	pinza para vasos Mehdon.....	362
pinza para histerectomia Heany-Ballentine.....	127	pinza para ligaduras DeBakey-Rumel.....	499	pinza para vasos perifericos Dale.....	494, 495
pinza para histerectomia Holzbach.....	126	pinza para ligaduras Mixer-DeBakey.....	499/2	pinza para vasos perifericos DeBakey.....	494
pinza para histerectomia Landau-Segond.....	125	pinza para ligaduras Rumel-DeBakey.....	499	pinza para vasos perifericos Jones-Leland.....	495
pinza para histerectomia Maingot.....	123/1, 123/2	pinza para lobo anterior Millin.....	551	pinza para vasos perifericos Leland-Jones.....	495
pinza para histerectomia Segond.....	125	pinza para magullar tabique Rubin.....	428	pinza para vasos Satinsky.....	491
pinza para histerectomia Landau-Segond.....	125	pinza para medicacion Bryant.....	137	pinza pico plano.....	317, 320
pinza para histerectomia Wertheim.....	124, 128	pinza para microcirugia.....	96	pinza porta esponja Bozemann.....	138
pinza para histerectomia Wertheim-Cullen.....	125	pinza para micro-cirugia de la laringe.....	474	pinza porta esponja Bozemann-Douglas.....	138
pinza para hueso Bircher-Ganske.....	246	pinza para oclusion tangencial DeBakey-Satinsky.....	502	pinza porta esponja Cheron.....	137
pinza para hueso Dingmann.....	246	pinza para oclusion tangencial Satinsky-DeBakey.....	502	pinza porta esponja Collin.....	137
pinza para hueso Farabeuf.....	243	pinza para parametrio.....	128/1	pinza porta esponja Douglas-Bozemann.....	138
pinza para hueso Farabeuf-Lambotte.....	243	pinza para parametrio Reda.....	128/1	pinza porta esponja Lister (Sinus).....	137
pinza para hueso Fergusson.....	243	pinza para pediculo Herrick.....	123	pinza porta esponja Pelkmann.....	137
pinza para hueso Ganske-Bircher.....	246	pinza para pericraneos Gauss.....	605	pinza porta esponja Sinus (Lister).....	137
pinza para hueso Kern.....	244	pinza para peritoneo Faure.....	123	pinza porta-esponja Duplay.....	134
pinza para hueso Lambotte.....	244	pinza para peritoneo Mikulicz.....	123	pinza porta-esponja Gross-Maier.....	134
pinza para hueso Lambotte-Farabeuf.....	243	pinza para peritoneo Phaneuf.....	123	pinza porta-esponja Maier-Gross.....	134
pinza para hueso Lane.....	244	pinza para polipos Hartmann.....	412	pinza porta-esponja Maier-Sims.....	134
pinza para hueso Langenbeck.....	243	pinza para polipos Hartmann-Hoffmann.....	412	pinza porta-esponja Sims-Maier.....	134
pinza para hueso Lewin.....	246	pinza para polipos Hartmann-Wullstein.....	412	pinza sacabocado Citelli.....	430
pinza para hueso Patella.....	248	pinza para polipos Hoffmann-Hartmann.....	412	pinza sacabocado craneal Cone.....	331
pinza para hueso Reda.....	246	pinza para polipos laringeos Jurasz.....	471	pinza sacabocado craneal DeVilbiss.....	332
pinza para hueso Reill.....	248	pinza para polipos Littauer.....	425	pinza sacabocado Hajek-Kofler.....	431
pinza para hueso Semb.....	243	pinza para polipos Noyes.....	425	pinza sacabocado Kofler-Hajek.....	431
pinza para hueso Ulrich.....	248	pinza para polipos Struempel.....	412	pinza sacabocado Ostroem.....	430
pinza para hueso Verbrugge.....	245	pinza para polipos uterinos Doyen.....	585	pinza sacabocado para discos intervertebral	
pinza para huesos.....	243-250	pinza para polipos uterinos Kelly.....	585	Colclough.....	344/1
pinza para huesos autocentrantes.....	245	pinza para polipos uterinos Noto.....	585	pinza sacabocado para discos intervertebral	
pinza para huesos Feldheim.....	249	pinza para polipos Wullstein-Hartmann.....	412	Ferris-Smith-Kerrison.....	344, 344/2
pinza para huesos Hoglund-Lowman.....	249	pinza para quitar agrafes Collin.....	224	pinza sacabocado para discos intervertebral	
pinza para huesos Lambert-Lowman.....	249	pinza para quitar agrafes Heath-Richter.....	224	Kerrison-Ferris-Smith.....	344, 344/2
pinza para huesos Lowman.....	249	pinza para quitar agrafes Richter-Heath.....	224	pinza sacabocado para discos intervertebral	
pinza para huesos Lowman-Hoglund.....	249	pinza para reduction.....	246	Smith-Kerrison-Ferris.....	344, 344/2
pinza para huesos Lowman-Lambert.....	249	pinza para reposicion Rowe.....	459	pinza Smith.....	463
pinza para huesos Meyer.....	248	pinza para secuestros.....	249	pinza tira-lengua Collin.....	453
pinza para introducir cateter Magill.....	28	pinza para secuestros Van Buren.....	249	pinza tira-lengua Young.....	453
pinza para iris Barraquer (Colibri).....	384	pinza para senoscopia.....	431	pinza Ultra-Ligera.....	95
pinza para iris Barraquer-Katzin.....	384	pinza para separar la rama Smith.....	463	pinza uterina Adair.....	582
pinza para iris Barraquer-Harman.....	386	pinza para shunt carotido Javid.....	511	pinza uterina Barrett.....	582
pinza para iris Colibri.....	384	pinza para sostener placas Lane.....	325	pinza uterina Braun.....	582
pinza para iris Colibri (Barraquer).....	384	pinza para sostener tornillos Lane.....	325	pinza uterina Czerny.....	584
pinza para iris Colibri (Troutman).....	384	pinza para sutura Bonn Mod.....	386	pinza uterina Duplay.....	582
pinza para iris Fischer.....	384	pinza para sutura Castroviejo.....	392	pinza uterina Hulka.....	583
pinza para iris Foerster.....	383	pinza para sutura Mod. Bonn.....	386	pinza uterina Iowa.....	584
pinza para iris Gill.....	384	pinza para sutura Mod. Tübingen.....	386	pinza uterina Jacobs.....	583
pinza para iris Gill-Hess.....	384	pinza para sutura Moorfield.....	392	pinza uterina Jarcho.....	583
pinza para iris Graefe.....	382	pinza para sutura St. Martin.....	392	pinza uterina Moore-Staude.....	582
pinza para iris Katzin-Bishop.....	386	pinza para sutura Tübingen Mod.....	386	pinza uterina Museux.....	583
pinza para iris Hess.....	384	pinza para tabique nasal Graig.....	426	pinza uterina Palmer-Pozzi.....	582
pinza para iris Hess-Gill.....	384	pinza para tabique nasal Jansen-Middleton.....	430	pinza uterina Pozzi (Schroeder).....	582
pinza para iris Hess-Barraquer.....	384	pinza para tabique nasal Middleton-Jansen.....	430	pinza uterina Pozzi-Palmer.....	582
pinza para iris Stevens.....	383	pinza para tapones.....	135, 471	pinza uterina Pratt.....	584
pinza para iris Troutman.....	389	pinza para tapones Jackson.....	471	pinza uterina Schröder.....	584
pinza para iris Troutman (Colibri).....	384	pinza para tapones Ulrich.....	135	pinza uterina Schroeder.....	583
pinza para la aorta DeBakey-Morris.....	506	pinza para tejido Collin.....	539	pinza uterina Schroeder (Pozzi).....	582
pinza para la aorta Dietrich.....	510	pinza para tejido Duval.....	539	pinza uterina Skene.....	582
pinza para la aorta Miniature-Subramanian.....	521	pinza para tejido Williams.....	539	pinza uterina Staude-Moore.....	582
pinza para la aorta Morris-DeBakey.....	506	pinza para tendones Larsen.....	292	pinza uterina Teale.....	583
pinza para la aorta Subramanian.....	521	pinza para torcer hilo Berry.....	319	pinza vascular Cooley.....	520
pinza para la aorta Subramanian-Miniature.....	521	pinza para torcer hilo Corwin-Hegar.....	319	pinza vascular Dardik.....	509/1
pinza para la aorta Weber.....	501	pinza para torcer hilo Haberisser-Mayo.....	319	pinza vascular de uso multiple Bainbridge.....	495/1-495/2
pinza para la aorta Wylie.....	501/1, 501/2	pinza para torcer hilo Hegar-Corwin.....	319	pinza vascular de uso multiple Cooley.....	518-520, 520/2
pinza para laringe Fraenkel.....	471	pinza para torcer hilo Mayo-Haberisser.....	319		

pinza vascular de uso		porta aguja Stevens .....	214	Ramus separador para el ramo .....	461
multiple DeBakey .....	495/2, 507, 508, 514, 515	porta aguja Stratte .....	212	Randall cureta aspiradora para biopsia uterina .....	587
pinza vascular Neonatal .....	523	porta aguja Wangenstein .....	210	Randall pinza para calculos renales .....	535
pinza vascular para neontales Castaneda .....	527	porta aguja Webster .....	208	Raney grapa para cuero cabelludo .....	327
pinza vascular pediátrica Cooley .....	522	porta aguja Wood-Crile .....	209	Raney pinza aplicadora .....	327
pinza vascular pediátrica DeBakey .....	516, 517	porta aguja Young Boomerang .....	220	Rankin-Crile pinza hemostatica .....	107
Piper forceps obstetrico .....	604	porta esponjas Foerster .....	136	Rankin-DeBakey pinza hemostatica atraumatica .....	512
Pistola lavadora .....	626	porta esponjas Rampley .....	136	Rankin-Kelly pinza hemostatica .....	106
placa para extender la piel .....	49	porta ligadura para tourniquete .....	528	raquiotomo .....	267
placa para parpado Jaeger .....	371	porta pinza de traslado .....	615	Ray cureta para hipofisis .....	334
Plester cuchillo .....	418	porta-algodon .....	203	Recamier cureta uterina .....	597
Plester separador .....	171	porta-algodon Farrell .....	203	Reda cucharilla cortante .....	256
Plester tubo de aspiracion .....	338	porta-algodon Horne-Jobson .....	203	Reda cuchillo de hoz .....	435
polipotomo Krause .....	433/2	porta-algodon Jobson-Horne .....	203	Reda cuchillo para amputacion .....	44
polipotomo Krause-Voss .....	433/2	porta-algodon Reda .....	203	Reda diapason .....	403
polipotomo Voss-Krause .....	433/2	porta-algodon Tobold .....	203	Reda especulo nasal .....	423
polipotomo Wilde .....	433/2	porta-algodon Uckermann .....	203	Reda Excenter tijera para vendaje .....	69/2
Politzer aguja para paracentesis .....	408	porta-clamps DeMartel-Wolfson .....	546	Reda gancho .....	150
Politzer cuchillo auricular .....	408	porta-clamps Wolfson-DeMartel .....	546	Reda iman ocular .....	395
Politzer especulo auricular .....	399	portador de luz fria Kleinsasser .....	36	Reda instrumento para vendaje enyesado .....	232
Politzer oliva auricular .....	406	portador de luz Holinger .....	37	Reda micro tijera .....	77, 80
Poole tubo de aspiracion .....	27	portador de luz Jackson .....	37	Reda perforador de mano .....	300
porta aguja (micro) Barraquer .....	216, 217	Potts pinza para anastomosis .....	493	Reda pinza atraumatica .....	111
porta aguja (micro) Barraquer-Troutmann .....	216	Potts pinza para coartacion .....	492	Reda pinza autocentradora para sostener huesos .....	247
porta aguja (micro) Castroviejo-Standard .....	216	Potts-DeMartel tijera vascular .....	59	Reda pinza de reduction .....	247
porta aguja (micro) Standard-Castroviejo .....	216	Potts-Smith pinza de diseccion .....	81, 81/1	Reda pinza depilatoria .....	395
porta aguja (micro) Troutmann-Barraquer .....	216	Potts-Smith tijera vascular .....	61	Reda pinza para hueso .....	246
porta aguja Adson .....	211	Pozzi (Schroeder) pinza uterina .....	582	Reda pinza para parametrio .....	128/1
porta aguja Arruga .....	214	Pozzi-Palmer pinza uterina .....	582	Reda porta-algodon .....	203
porta aguja Arruga-Kalt .....	214	Pratt dilatador uterino .....	580	Reda rompe hojas .....	45
porta aguja Baby-Olsen-Hegar .....	212	Pratt especulo rectal .....	559	Reda sierra para abrir anillos .....	297
porta aguja Baumgartner .....	208	Pratt pinza hemostatica .....	110	Reda sonda conductora .....	221/1
porta aguja Boomerang Young .....	220	Pratt pinza uterina .....	584	Redon aguja de guia .....	207
porta aguja Boynton .....	214	Pratt sonda para fistula .....	563	Rees tijera face lift .....	73
porta aguja Bozemann .....	211	Precisa esfigmomanometro .....	9	regla .....	25
porta aguja Brown .....	209	Presameter-Nova esfigmomanometro .....	6	Reichert depresor para epiglotis .....	471
porta aguja Castroviejo .....	215	Presbyterian pinza cierra-tubo .....	129	Reill pinza para hueso .....	248
porta aguja Castroviejo-Micro .....	215	Price-Thomas pinza bronquial .....	490	Reiner cuchillo para vendaje enyesado .....	233
porta aguja Collier .....	208	Prince pinza muscular .....	386	Reiner jeringa auricular .....	406
porta aguja Crile .....	213	Prince tijera para amigdalas .....	59	Reinke-Lopez elevador para amigdalas .....	465
porta aguja Crile-Murray .....	209	protoscopio Bensaude .....	565	Resano pinza intestinal .....	542
porta aguja Crile-Wood .....	209	protoscopio Fansler .....	564	Resano tijera para capsula .....	53/2
porta aguja DeBakey .....	210	protoscopio Kelly .....	562, 563	retractor nasal Aufricht .....	447
porta aguja Derf .....	208	protoscopio Morgan .....	565	retractor nasal Cottle .....	447, 447/1
porta aguja Finocchio .....	211	protector Arruga .....	378	retractor nasal Kilner .....	447/1
porta aguja Gillies .....	212	Providence-Hospital pinza hemostatica .....	106	retractor nasal Masing .....	447
porta aguja Halsey .....	208	punta de pinza Baracani .....	472	retractor nasal Masing-Neivert .....	447
porta aguja Heaney .....	210	punta de pinza Bruenings .....	472	retractor nasal Neivert-Masing .....	447
porta aguja Hegar-Baby-Olsen .....	212	punta de pinza Cordes .....	472	retractor para amputacion Percy .....	296
porta aguja Hegar-Mayo .....	209	punta de pinza Fraenkel .....	472	Reverdin aguja .....	220
porta aguja Hegar-Olsen .....	212	punta de pinza Krause .....	472	Reverdin separador abdominal .....	143/3
porta aguja Hoesel .....	213	punta de pinza Lange .....	472	Reynolds tijera para cirugía .....	54/1
porta aguja Jacobsen .....	215	punta de pinza Scheimann .....	472	Reynolds tijera supercut .....	72
porta aguja Johnson .....	211	punta de pinza Schumacher .....	472	Ribbon espátula abdominal .....	143/1
porta aguja Kalt .....	214	punta de pinza Seifert .....	472	Ricard separador abdominal .....	191
porta aguja Kalt-Arruga .....	214	Putti lima para huesos .....	294	Richardson Grip separador .....	142
porta aguja Kilner .....	212	Pynchon-Andrew tubo de aspiracion .....	28	Richardson separador .....	142
porta aguja Langenbeck .....	213			Richardson-Eastman separador .....	142
porta aguja Lichtenberg .....	213			Richnau-Holmgren especulo auricular .....	400
porta aguja Masson .....	210	Q		Richter-Heath pinza para quitar agrafes .....	224
porta aguja Mathieu .....	213	Quervain periostotomo .....	275	Rienhoff-Finocchio separador costal .....	486
porta aguja Mathieu-Olsen .....	212	Quire elevador para cuerpos extraños .....	412	Rigby separador .....	189/2
porta aguja Mayo-Hegar .....	209	Quisling martillo .....	271	Ri-Mini estuche de diagnostico .....	17
porta aguja Metzenbaum .....	211	quistotomo Becker .....	375	Ring baja-lengua .....	455
porta aguja Micro-Castroviejo .....	215	quistotomo Graefe .....	375	riñoneras .....	619
porta aguja Microvascular .....	210	quita hojas .....	42	Ritter-Halle dilatador para el seno .....	433
porta aguja Murray-Crile .....	209			Robb disecador vascular .....	530
porta aguja Neivert .....	208	R		Robb espátula para la intima .....	530
porta aguja Olsen-Hegar .....	212	Radolf pinza para arrancar uñas .....	297	Roberts pinza hemostatica .....	117
porta aguja Olsen-Hegar-Baby .....	212	Ragnell separador .....	140	Robson-Mayo pinza intestinal .....	541
porta aguja Olsen-Mathieu .....	212	Ragnell/Kilner tijera supercut .....	72	Rochard separador abdominal .....	186
porta aguja Ryder .....	210	Ralk perforador de mano .....	300	Rochester-Carmalt pinza hemostatica .....	109
porta aguja Sarot .....	211	Rampley porta esponjas .....	136	Rochester-Ochsner pinza hemostatica .....	108



Rochester-Pean pinza hemostatica.....	108	Schioetz tonometro.....	394/2	separador abdominal Rochard.....	186
Roeder pinza de campo.....	132	Schlesinger pinza cortante para laminectomia.....	342	separador abdominal Us-Balfour.....	184
Roger elevador para el tabique nasal.....	437	Schmeden pinza nasal.....	427	separador Adams-Mayo.....	171
Roger pinza traumatica.....	127	Schmid canula para lavador vascular.....	338	separador Adson.....	172-174
Rogge pinza para esterilizacion.....	227	Schmidt-Moritz baja-lengua.....	452	separador Adson Anderson.....	172
Rollet cincel para extirpacion.....	374	Schmieden sonda conductora.....	221	separador Adson-Beckmann.....	175
Rollet gancho.....	375	Schmieden-Dick aguja para ligadura.....	219	separador Alm.....	168
rompe hojas Castroviejo.....	45	Schmieden-Payr sonda conductora.....	221	separador Anderson.....	198
rompe hojas Chris-Troutman.....	45	Schmieden-Taylor tijera duramadre.....	65/1	separador Anderson Adson.....	172
rompe hojas Reda.....	45	Schmidt pinza para coger las amigdalas.....	467	separador Aufranc-Cobra.....	289
rompe hojas Troutman-Chris.....	45	Schoenborn separador para la glandula tiroidea.....	479	separador Baby Roux.....	140
Rose separador.....	140	Schröder cureta uterina.....	595	separador Beckmann.....	176
Rosen cuchillo.....	418	Schröder pinza uterina.....	584	separador Beckmann-Adson.....	175
Rosen gancho.....	419	Schroeder (Pozzi) pinza uterina.....	582	separador Beckmann-Eaton.....	176
Rosen tubo de aspiracion.....	338	Schroeder pinza uterina.....	583	separador Brunner.....	167
Roser-Koenig abre-boca.....	454	Schubert pinza para biopsia.....	588	separador Burrows-Jackson.....	189/2
Ross separador.....	148/1	Schuhknecht cuchillo.....	418	separador Caspar.....	179
Ross separador para aorta.....	148/1	Schultze salpingografo.....	596	separador Cloward.....	178/1-178/4
rotador Bechert.....	379	Schulze-Bergmann especulo rectal.....	560	separador Cobra-Aufranc.....	289
Roux Baby separador.....	140	Schumacher pinza para biopsia.....	588, 589	separador Collin.....	139
Roux mini separador.....	140	Schumacher punta de pinza.....	472	separador Collin-Hartmann.....	141
Roux separador.....	139	Schumacher tijera para cordon umbilical.....	64	separador Collins-Mayo.....	141
Rowe pinza para reposicion.....	459	Schumacher tijera para esternon.....	481	separador Contour-Scalp.....	169
Rubin cincel nasal.....	440	Schweigger pinza capsular.....	391	separador Cooley.....	148
Rubin pinza para magullar tabique.....	428	Scoville cucharilla cortante.....	253	separador Coronol Blow Lift.....	198
Rudd ligador para hemorroides.....	568	Scoville separador para la raiz de nervios.....	329/1, 330	separador Coryllos (Thorax).....	166
Rumel pinza hemostatica.....	117	Scoville separador para laminectomia.....	196	separador costal Burford-Finochietto.....	483
Rumel-Belmont tournique.....	528	Scoville-Haverfield separador para laminectomia.....	196	separador costal Cooley.....	485, 487
Rumel-DeBakey pinza para ligaduras.....	499	Scudder pinza intestinal.....	541	separador costal DeBoer.....	486
Ruskin pinza gubia.....	239	Sebileau periostotomo.....	275	separador costal Favalaro-Morse.....	484
Ruskin-Liston pinza cortante para huesos.....	241	Sedillot periostotomo.....	274, 275	separador costal Finochietto.....	482, 484
Ruskin-Stille pinza gubia.....	239	Segond bisturi para fibroma.....	594	separador costal Finochietto-Burford.....	483
Russel-Davis baja-lengua.....	458	Segond pinza para histerectomia.....	125	separador costal Finochietto-Rienhoff.....	486
Rydel-Seiffert diaposon.....	404	Segond-Landau pinza para histerectomia.....	125	separador costal Haight.....	487
Ryder porta aguja.....	210	Seifert punta de pinza.....	472	separador costal Morse.....	484
S		Seiffert-Rydel diaposon.....	404	separador costal Morse-Favaloro.....	484
Saalfeld saca comedones.....	608	Seldin periostotomo.....	277	separador costal Rienhoff-Finochietto.....	486
saca comedones Saalfeld.....	608	Sellheim separador obstetrico.....	607	separador costal Tuffier.....	487
saca comedones Schamberg.....	608	Sellors aproximador para costillas.....	489/1	separador Crile.....	140
saca comedones Unna.....	608	Sellors-Crafoord pinza hemostatica.....	119	separador cuello vejiga Millin.....	553
saca comedones Walton.....	608	Semb periostotomo.....	278	separador Cushing.....	151-153
Sachs elevador para duramadre.....	332	Semb pinza bronquial.....	491	separador Czerny.....	141
Sachs gancho para nervio.....	329	Semb pinza cortante para huesos.....	242	separador Doyen.....	178
Saenger pinza para aborto.....	606	Semb pinza gubia.....	240	separador Davidson (Scapula).....	166
salpingografo Schultze.....	596	Semb pinza para hueso.....	243	separador de mobilizacion Tessier.....	463/3
Sanvenero tijera para cirugia.....	54/1	Semb-DeBakey pinza para ligadura y la aorta.....	499	separador de pelvis St. Marks.....	165
Sarot pinza hemostatica.....	118	Semken pinza de diseccion.....	86	separador de sistema Leyla.....	368-368/3
Sarot porta aguja.....	211	Semm especulo vaginal.....	571	separador Deaver.....	145, 146
Satinsky pinza para vasos.....	491	Senn-Green separador.....	153	separador Deaver Grip.....	146
Satinsky tijera para vasija.....	65/2	Senn-Miller separador.....	143	separador DeBakey.....	189/1
Satinsky-DeBakey pinza para oclusion tangencial.....	502	sensimetro Wartenberg.....	25	separador Desmarres.....	151
Satterlee sierra para amputacion.....	296	separador abdominal Baby Balfour.....	182, 183	separador Doyen.....	163
Sauerbruch costotomo.....	481	separador abdominal Baby Gosset.....	181	separador Doyen-Stille.....	167
Sauerbruch pinza gubia.....	240	separador abdominal Back holder.....	192-195	separador Eastman-Richardson.....	142
Sauerbruch pinza para desechos.....	227	separador abdominal Balfour.....	182, 183	separador Eaton-Beckmann.....	176
Sauerbruch separador.....	164, 166	separador abdominal Balfour Baby.....	182, 183	separador espinal Taylor.....	291
Sauerbruch-Frey costotomo.....	481	separador abdominal Balfour-Us.....	184	separador Farabeuf.....	139
Sawtell pinza para coger las amigdalas.....	467	separador abdominal Browne-Denis.....	185	separador Finsen.....	168
Sawyer especulo rectal.....	560	separador abdominal Chamley.....	289	separador Freeman.....	198
Sayre elevador.....	281	separador abdominal Collin.....	190	separador Friedmann.....	477, 577
Scaglietti pinza gubia.....	240	separador abdominal Collin Loktite.....	191	separador Fritsch.....	163
Scalp-Contour separador.....	169	separador abdominal Denis-Browne.....	185	separador Gil-Vernet.....	152
Scapula (Davidson) separador.....	166	separador abdominal Doyen.....	189/1	separador Goelet.....	141
Schaedel pinza de campo.....	132	separador abdominal Frazier.....	181	separador Green.....	160
Schamberg saca comedones.....	608	separador abdominal Gosset.....	181	separador Green-Langenbeck.....	153
Schede cucharilla cortante.....	251	separador abdominal Gosset Baby.....	181	separador Green-Senn.....	153
Scheidel-Hepp micro tijera.....	78	separador abdominal Kirschner.....	185-187/1	separador Grip Deaver.....	146
Scheie cuchillo para goniotomia.....	373	separador abdominal Kummel.....	143/4	separador Grip Kelly.....	142
Scheinmann punta de pinza.....	472	separador abdominal Loktite Collin.....	191	separador Grip Richardson.....	142
Scherbak especulo vaginal.....	575	separador abdominal O'Connor-O'Sullivan.....	181	separador Harrington.....	147
Schimmelbusch tambores para esterilizacion.....	622	separador abdominal O'Sullivan-O'Connor.....	181	separador Harrington-Pemberton.....	147
Schink dermatomo.....	49	separador abdominal Reverdin.....	143/3	separador Hartmann-Collin.....	141
		separador abdominal Ricard.....	191	separador Hasson.....	143

separador Heaney.....	164	separador para rodilla Blount.....	289	sierra nasal Joseph.....	446
separador Henley.....	170	separador para tejido cervical Cloward.....	339	sierra oscilante con aspiracion.....	231-231/1
separador Hibbs.....	164	separador para tendones Bunell.....	292	sierra oscilante para vendajes enyesados.....	230/10-230/18
separador Holzheimer.....	168	separador para uvula Love.....	465	sierra para abrir anillos Reda.....	297
separador Hösel.....	167	separador para yesos Beeson.....	232	sierra para abrir anillos Walton.....	297
separador intestinal Leriche.....	143/4	separador para yesos Haglund-Stille.....	232	sierra para amputacion Bier.....	296
separador intra oral.....	463/1, 463/4	separador para yesos Henning.....	232	sierra para amputacion Charriere.....	296
separador intra oral L&M.....	463/4	separador para yesos Stille-Haglund.....	232	sierra para amputacion Langenbeck.....	296
separador Israel.....	162	separador Parker.....	139	sierra para amputacion Satterlee.....	296
separador Jackson-Burrows.....	189/2	separador Parker-Langenbeck / Us Army.....	141	sierra para autopsia.....	230-230/9
separador Jansen.....	168	separador Pemberton-Harrington.....	147	sierra para vendajes enyesados Engel.....	229
separador Joll.....	477, 577	separador perineal Gelpi.....	189/1, 189/2	sileta.....	621/1
separador Kelly.....	142, 164	separador Perkins.....	168	Silver cincel nasal.....	442
separador Kelly Grip.....	142	separador Plester.....	171	Silver dermatomo.....	50
separador Kocher.....	155	separador prostatico Young.....	550	Simcoe canula.....	394/2
separador Kocher.....	159, 160, 163	separador Ragnell.....	140	Simon cucharilla uterina.....	594
separador Kocher-Langenbeck.....	159	separador rectal Buie-Smith.....	561	Simon separador.....	164
separador Koerte.....	162	separador rectal Smith-Buie.....	561	Simplex cierra-tubos.....	624
separador König.....	153	separador Richardson.....	142	Simpson forceps obstetrico.....	602
separador Körte.....	143/3	separador Richardson Grip.....	142	Simpson-Braun forceps obstetrico.....	602
separador Lahey.....	157	separador Richardson-Eastman.....	142	Simpson-Luikart forceps obstetrico.....	603
separador Langenbeck.....	158, 159	separador Rigby.....	189/2	Sims cureta uterina.....	597
separador Langenbeck-Green.....	153	separador Rose.....	140	Sims depresor uterino.....	586
separador Langenbeck-Kocher.....	159	separador Ross.....	148/1	Sims dilatador uterino.....	581
separador Little.....	157	separador Roux.....	139	Sims especulo rectal.....	559
separador Luer.....	140	separador Roux Baby.....	140	Sims especulo vaginal.....	573
separador mamarío Breast.....	198	separador Roux mini.....	140	Sims histero metro.....	586
separador manipulador Obwegeser.....	461/1	separador sagital Smith.....	463/5	Sims tijera ginecologica.....	62
separador Martin.....	175/1	separador Sauerbruch.....	164, 166	Sims-Maier pinza porta-esponja.....	134
separador Mathieu.....	141	separador Scalp-Contour.....	169	Singley pinza de diseccion.....	88
separador Mayo-Adams.....	171	separador Scapula (Davidson).....	166	Sinsky gancho.....	376
separador Mayo-Collins.....	141	separador Senn-Green.....	153	Sinus (Lister) pinza porta esponja.....	137
separador Meyerding.....	157, 177, 180	separador Senn-Miller.....	143	Sinus sonda para sinoscopia.....	438
separador Middeldorf.....	160	separador Simon.....	164	sistema de brazo.....	188, 189
separador Mikulicz.....	163	separador Stille-Doyen.....	167	Skene pinza uterina.....	582
separador Miller-Senn.....	143	separador Stille-Strandell.....	157	Sluder-Ballenger amigdalotomo.....	470
separador Mini Roux.....	140	separador Strandell-Stille.....	157	Smellie gancho obstetrico.....	605
separador Mollison.....	171	separador Thorax (Coryllos).....	166	Smellie perforacraneo.....	607
separador Morris.....	164	separador toracico Mercedes.....	489	Smillie meniscotomo.....	292
separador Murphy.....	156	separador traqueal Bose.....	476	Smillie separador para menisco.....	291
separador nasal Converse.....	448	separador traqueal Jackson.....	476	Smith bifeleostato.....	370
separador Norfolk / Norwich.....	172	separador Travers.....	172	Smith pinza.....	463
separador Norfolk / Norwich.....	172	separador Tuffier.....	147	Smith pinza para separar la rama.....	463
separador obstetrico Sellheim.....	607	separador Us Army / Parker-Langenbeck.....	141	Smith separador sagital.....	463/5
separador Ollier.....	162	separador Vernet-Gil.....	152	Smith Us Army tijera para gaza.....	69/1
separador para aorta Ross.....	148/1	separador vesical Judd-Masson.....	552	Smith-Buie separador rectal.....	561
separador para cirugia plastica Ferriera.....	197	separador vesical Legueu.....	553	Smith-Ferris pinza cortante para laminectomia.....	343
separador para cirugia plastica Tebbetts.....	197	separador vesical Masson-Judd.....	552	Smith-Ferris pinza de diseccion.....	85
separador para cuerpo vertebral Cloward.....	339	separador vesical Millin.....	552	Smith-Heywood pinza hemorroidal.....	567
separador para cuerpo vertebral Inge.....	339	separador vesical Thomson-Walker.....	552	Smith-Kerrison-Ferris pinza sacabocado para	
separador para el borde anterior Hargis.....	463	separador vesical Walker-Thomson.....	552	discos intervertebral.....	344, 344/2
separador para el cuerpo mandibular Hargis.....	463/6	separador Volkman.....	153-156	Smith-Petersen cincel.....	261
separador para el ramo Nasalis-Spina.....	461	separador Weitlaner.....	169	Smith-Petersen gubia.....	261
separador para el ramo Ramus.....	461	separador Weitlaner-Wullstein.....	169	Smith-Petersen pinza gubia.....	238
separador para el ramo Spina-Nasalis.....	461	separador Wullstein.....	171	Smith-Potts pinza de diseccion.....	81, 81/2
separador para la glandula tiroidea Schoenborn.....	479	separador Wullstein-Weitlaner.....	169	Smith-Potts tijera vascular.....	61
separador para la raiz de nervios D'Errico.....	329/2	separador Yancoskie.....	198	Smithwick gancho para nervio.....	329
separador para la raiz de nervios Hess.....	329/1	separador Zenker.....	161	Smithwick pinza aplicadora.....	326
separador para la raiz de nervios Holsher.....	329/1	Serpentine Grasper pinza para biopsia.....	593	Snellen asa.....	378
separador para la raiz de nervios Love.....	329/2, 330	serra-fina Dieffenbach.....	104	Snellen pinza muscular.....	393
separador para la raiz de nervios Scoville.....	329/1, 330	serra-fina Hopkins-Johns.....	104	Socket and Ball pinza para campo.....	133
separador para labios y mejillas.....	453	serra-fina Johns-Hopkins.....	104	Somer pinza para el utero.....	585
separador para labios y mejillas Sternberg.....	453	Seutin tijera para vendaje.....	69/2	sonda abotonada Jacobson.....	335
separador para laminectomia Cherry.....	488	Sexton cuchillo auricular.....	408	sonda acanalada.....	199
separador para laminectomia Haverfield-Scoville.....	196	Shambaugh gancho.....	419	sonda acanalada Brodie.....	199
separador para laminectomia Scoville.....	196	Shapleigh asa.....	410	sonda auricular Stacke.....	199
separador para laminectomia Scoville-Haverfield.....	196	Shea tijera auricular micro.....	413	sonda conductora Brunner.....	221, 221/1
separador para mamaria.....	486/1	Sheehan cincel nasal.....	441	sonda conductora Kirschner.....	221
separador para menisco Smillie.....	291	Sheets canula.....	394/2	sonda conductora Koenig.....	221/1
separador para paladar Nager.....	465	Sherman-Stille perforador de mano.....	298	sonda conductora Payr.....	221/1
separador para partes blandas Obwegeser.....	460	Siebold tijera ginecologica.....	62	sonda conductora Payr-Schmieden.....	221
separador para pilar Hofer.....	465	Siegle especulo auricular.....	402	sonda conductora Reda.....	221/1
separador para piloro Benson.....	544	sierra hilo Olivecrona.....	332	sonda conductora Schmieden.....	221

sonda conductora Schmieden-Payr.....	221	Strauss pinza para el pene.....	553/1	tijera de diseccion Weller.....	53/2
sonda conductora Vienna.....	221/1	Struempel pinza para polipos.....	412	tijera de incision.....	52
sonda Fish.....	199	Strully tijera para neurocirugia.....	65	tijera DeBakey.....	60
sonda Harms.....	381	Struycken pinza nasal.....	427	tijera duramadre Schmieden-Taylor.....	65/1
sonda lacrimal Bowman.....	381	Subramanian pinza para la aorta.....	521	tijera duramadre Taylor-Schmieden.....	65/1
sonda lacrimal Worst.....	381	Subramanian-Miniature pinza para la aorta.....	521	tijera Enucleation.....	58
sonda metalica Walther.....	555	supercut tijera.....	71, 72	tijera face lift Freeman.....	73
sonda Nelaton.....	199	supercut tijera Baby Metzenbaum.....	71	tijera face lift Gorney.....	73
sonda para bocio Kocher.....	479	supercut tijera Iris.....	72	tijera face lift Joseph Peck.....	73
sonda para calculos biliares Mayo.....	534	supercut tijera Kilner/Ragnell.....	72	tijera face lift Kaye.....	73
sonda para fistula Lockhart-Mummery.....	200	supercut tijera La Grange.....	72	tijera face lift Peck Joseph.....	73
sonda para fistula Mummery-Lockhart.....	200	supercut tijera Lister.....	72	tijera face lift Rees.....	73
sonda para fistula Pratt.....	563	supercut tijera Mayo.....	71	tijera ginecologica Doyen.....	63
sonda para mesurar House.....	420	supercut tijera Mayo-Stille.....	71	tijera ginecologica Dubois.....	63
sonda para sinoscopia Sinus.....	438	supercut tijera Metzenbaum.....	71	tijera ginecologica Siebold.....	62
soporte de esterilizacion para alambres de Kirschner.....	305	supercut tijera Metzenbaum Baby.....	71	tijera ginecologica Sims.....	62
soporte de pecho Negus.....	459	supercut tijera Ragnell/Kilner.....	72	tijera ginecologica Wertheim.....	63
soporte pectoral Kleinsasser.....	36	supercut tijera Reynolds.....	72	tijera Martin-Cartilage.....	65/1
Spencer tijera para ligadura.....	66	supercut tijera Stevens.....	72	tijera nasal.....	428, 429
Spencer-Wells pinza hemostatica.....	109	supercut tijera Stille-Mayo.....	71	tijera nasal Cottle.....	59
Spinal cucharilla cortante.....	253	supercut tijera wagner.....	72	tijera nasal Fomon.....	58
Spina-Nasalis separador para el ramo.....	461	Sweet pinza aplicadora.....	326	tijera nasal Heymann.....	58
Spratt cucharilla cortante.....	251	Systrunk tijera para cirugia.....	66	tijera nasal Watson-Williams.....	428
Spurling pinza cortante para laminectomia.....	340			tijera nasal Williams-Watson.....	428
St. Marks separador de pelvis.....	165	<b>T</b>		tijera Northbent.....	66
St. Martin pinza para sutura.....	392	Tabb cuchillo.....	418	tijera para alambre y laminas Universal.....	67
St. Clair-Thomson cuchillo para vegetaciones adenoides.....	450	Takahashi pinza nasal.....	427	tijera para amigdalas.....	59
Stacke sonda auricular.....	199	taladros.....	302	tijera para amigdalas Boettcher.....	59
Stamm pinza cortante para huesos.....	241	tambores para esterilizacion Schimmelbusch.....	622	tijera para amigdalas Dean.....	59
Standard (Nelson) trocar abdominal.....	204	tamponeador LUniatschek.....	465	tijera para amigdalas Good.....	59
Standard estuche para sutura.....	226	Tarnier cranioclasto.....	607	tijera para capsula Pesano.....	53/2
Standard pinza de diseccion.....	81, 81/1	Tarnier forceps obstetrico.....	604	tijera para cartilago McIndoe.....	65/1
Standard tijera para cirugia.....	51	tarros.....	620	tijera para cirugia Cottle.....	56
Staude-Moore pinza uterina.....	582	Taylor martillo de percusion.....	24	tijera para cirugia Graeffe.....	56
Steinmann alambre.....	307, 308	Taylor pinza de diseccion.....	87	tijera para cirugia Iris.....	54/2
Steinmann pinza de agarre para tendones.....	292	Taylor separador espinal.....	291	tijera para cirugia Joseph.....	54/1
Stellbrink pinza gubia.....	234	Taylor-Cushing pinza de diseccion.....	87	tijera para cirugia Kilner.....	54/1
Sternberg separador para labios y mejillas.....	453	Taylor-Schmieden tijera duramadre.....	65/1	tijera para cirugia Knapp.....	55
Stevens gancho para cristalino.....	375	Teale pinza uterina.....	583	tijera para cirugia Littler.....	55
Stevens pinza para iris.....	383	Tebbetts separador para cirugia plastica.....	197	tijera para cirugia Metzenbaum.....	54
Stevens porta aguja.....	214	tensor de cierra-hilo Demel.....	315	tijera para cirugia Reynolds.....	54/1
Stevens tijera para tenotomia.....	58	tensor de cierra-hilo Loute.....	315	tijera para cirugia Sanvenero.....	54/1
Stevens tijera supercut.....	72	tensor de taladros.....	313	tijera para cirugia Standard.....	51
Stevenson blearostato.....	371	Terson pinza capsular.....	391	tijera para cirugia Systrunk.....	66
Stieglitz pinza para espinas.....	92	Tessier separador de mobilizacion.....	463/3	tijera para cirugia Waldmann.....	64
Stille (Leksell) pinza gubia.....	240	Thierry forceps obstetricos.....	603	tijera para cordon umbilical Busch.....	64
Stille cincel.....	260	Thomas cureta uterina.....	599	tijera para cordon umbilical Mod. USA.....	64
Stille cizalla para yesos.....	229	Thomas-Gaylor pinza para biopsia.....	588	tijera para cordon umbilical Schuhmacher.....	64
Stille costotomo.....	480	Thomas-Price pinza bronquial.....	490	tijera para cordon umbilical USA Mod.....	64
Stille gubia.....	260	Thoms-Allis pinza intestinal.....	538	tijera para corneales Castroviejo.....	79
Stille osteotomo.....	260	Thomson-St. Clair cuchillo para vegetaciones adenoides.....	450	tijera para encias Fox-Goldman.....	67
Stille perforador de mano.....	298	Thomson-Walker separador vesical.....	552	tijera para encias Goldman-Fox.....	67
Stille pinza de diseccion.....	81, 81/1	Thorax (Coryllos) separador.....	166	tijera para encias LaGrange.....	69
Stille pinza hemostatica.....	122	Thorex tijera vesicula biliar.....	65/2	tijera para encias Locklin.....	69
Stille-Barraya pinza de diseccion.....	88	Thudichum especulo nasal.....	421	tijera para encias Quinby.....	67
Stille-Giertz costotomo.....	481	Tieck-Halle especulo nasal.....	423	tijera para enterotomo.....	66
Stille-Haglund separador para yesos.....	232	tijera Adson-Tonnies.....	65	tijera para episiotomia Braun-Stadler.....	64
Stille-Horsley pinza cortante para huesos.....	242	tijera auricular micro Bellucci.....	413, 417	tijera para episiotomia Stadler-Braun.....	64
Stille-Liston pinza cortante para huesos.....	242	tijera auricular micro Shea.....	413	tijera para esternon Schumacher.....	481
Stille-Luer pinza gubia.....	239	tijera Cartilage-Martin.....	65/1	tijera para gaza Smith Us Army.....	69/1
Stille-Mayo tijera de diseccion.....	52/1	tijera corneal Aebli.....	58	tijera para gaza US Army Smith.....	69/1
Stille-Mayo tijera supercut.....	71	tijera cuticular.....	610	tijera para intestino Fergusson.....	66
Stille-Ruskin pinza gubia.....	239	tijera de diseccion Baby Lexer.....	53	tijera para iridectomia Castroviejo.....	79
Stille-Sherman perforador de mano.....	298	tijera de diseccion Deaver.....	52	tijera para iridectomia Vannas.....	79
Stille-Strandell separador.....	157	tijera de diseccion Jorgensen.....	53	tijera para iris Noyes.....	75
Stockmann pinza para el pene.....	553/1	tijera de diseccion Lexer.....	53	tijera para iris Wecker.....	75
Stone pinza para cerrar clamps.....	545	tijera de diseccion Lexner.....	53	tijera para ligadura Heath.....	66
Stone-Watt manguito de cierre.....	545	tijera de diseccion Mayo.....	52/1	tijera para ligadura Littauer.....	66
Stone-Watt pinza intestinal.....	545	tijera de diseccion Mayo-Noble.....	52/1	tijera para ligadura Spencer.....	66
Strabismus tijera.....	58	tijera de diseccion Mayo-Stille.....	52/1	tijera para ligaduras Wavecute.....	54
Strandell-Stille separador.....	157	tijera de diseccion Metzenbaum.....	53/1	tijera para neurocirugia.....	65
Strassburger pinza de diseccion.....	89	tijera de diseccion Noble-Mayo.....	52/1	tijera para neurocirugia Strully.....	65
Stratte porta aguja.....	212	tijera de diseccion Stille-Mayo.....	52/1	tijera para oftalmologia.....	57, 75, 79

tijera para oftalmología Barraquer Colibri.....	75	Townsend-Down-Mini pinza para biopsia.....	591	uretrotomo Otis .....	553
tijera para oftalmología Colibri Barraquer.....	75	Townsend-Up-Mini pinza para biopsia.....	591	Us Army / Parker-Langenbeck separador.....	141
tijera para oftalmología Gradle.....	57	Toybee especulo auricular.....	399	Us Army Smith tijera para gaza.....	69/1
tijera para parametrium.....	63	tractor Barton.....	603/2	USA Mod. tijera para cordón umbilical.....	64
tijera para preparación.....	65	tractor Bill.....	604	USA pinza de disección.....	81, 81/1
tijera para rinoplastia Fomon.....	65/1	tractor Bill-Luikart.....	604		
tijera para septo Killian.....	471	tractor Luikart-Bill.....	604	V	
tijera para tendón Westcott.....	75	transformador para mango de pila para laringoscopio.....	34	V. Petz aparato para suturar estómago y intestinos.....	549
tijera para tenotomía Stevens.....	58	Travers separador.....	172	vaina para tornillos.....	324
tijera para uñas.....	609, 614	treфина para aorta.....	528	Vailex histerometro.....	586
tijera para vasija Klinkenbergh-Loth.....	65/2	Trelat especulo vaginal.....	571	Van Buren buja dilatadora.....	554
tijera para vasija Loth-Klinkenbergh.....	65/2	trepano Keyes.....	608	Van Buren pinza para secuestros.....	249
tijera para vendaje.....	69/1, 69/2, 70	Tréthowan Lane elevador.....	290	Van Doren pinza para biopsia.....	588
tijera para vendaje Bergmann.....	69/1	trocar abdominal Nelson (Standard).....	204	Vannas tijera para iridectomía.....	79
tijera para vendaje Bruns.....	70	trocar abdominal Standard (Nelson).....	204	Varady instrumento para varices.....	202
tijera para vendaje Esmarch.....	69/2	trocar Douglas.....	204	vasos graduados.....	621
tijera para vendaje Excenter Reda.....	69/2	trocar Nelson.....	205	vendaje de compresión Esmarch.....	296
tijera para vendaje Knowles.....	70	trocar Ochsner.....	205	Verbrugge pinza para hueso.....	245
tijera para vendaje Lister.....	69/1	trocar para seno maxilar Coakley.....	204	Verbrugge-Müller elevador.....	286/2
tijera para vendaje Lorenz.....	70	trocar para seno maxilar Lichtwitz.....	204	Vernet-Gil separador.....	152
tijera para vendaje Reda Excenter.....	69/2	trocar para seno maxilar Pierce.....	204	Verres aguja para neumoperitoneo.....	206
tijera para vendaje Seutin.....	69/2	trocar Universal.....	204	Vienna especulo nasal.....	421
tijera para vendaje Universal.....	70	Troeltsch (Wilde) pinza auricular.....	410	Vienna Mod. especulo nasal.....	421
tijera para vesícula biliar Thorek.....	65/2	Troeltsch pinza nasal.....	424	Vienna sonda conductora.....	221/1
tijera pulmonares Crafoord.....	65/2	Troemner martillo de percusión.....	24	Virchow cuchillo para autopsia.....	48
tijera Strabismus.....	58	Trousseau-Baby dilatador traqueal.....	476	Virchow cuchillo para cerebro.....	48
tijera supercut.....	71, 72	Troutman (Colibri) pinza para iris.....	384	Volkmann cucharilla cortante.....	251, 257
tijera supercut Baby Metzenbaum.....	71	Troutman pinza para iris.....	389	Volkmann separador.....	153-156
tijera supercut Iris.....	72	Tübingen Mod. pinza para ligadura.....	392	Voltolini especulo nasal.....	421
tijera supercut Kilner/Ragnell.....	72	Tübingen Mod. pinza para sutura.....	386	Voss-Krause polipotomo.....	433/2
tijera supercut La Grange.....	72	Tübingen pinza para ligadura.....	392	Vu-More especulo vaginal.....	569
tijera supercut Lister.....	72	Tübingen pinza para sutura.....	386		
tijera supercut Mayo.....	71	tubo de aspiración.....	27, 28, 337, 337/2, 338	W	
tijera supercut Mayo-Stille.....	71	tubo de aspiración Adson.....	337	Wachenfeldt pinza para aplicar agujas.....	224
tijera supercut Metzenbaum.....	71	tubo de aspiración Andrew-Pynchon.....	28	Wadsworth-Todd cauterio.....	378
tijera supercut Ragnell/Kilner.....	72	tubo de aspiración Baby-Yankauer.....	27	Wagener gancho abotonado.....	409
tijera supercut Reynolds.....	72	tubo de aspiración Ferguson.....	337	Wagener-Mosher canula para traqueotomía.....	477
tijera supercut Stevens.....	72	tubo de aspiración Ferguson/Frazier.....	337	Wagner pinza cortante para laminectomía.....	343
tijera supercut Stille-Mayo.....	71	tubo de aspiración Frazier/Ferguson.....	337	Wagner tijera.....	67
tijera supercut Wagner.....	72	tubo de aspiración House.....	337/2	Wagner tijera supercut.....	72
tijera Toennis-Adson.....	65	tubo de aspiración Plester.....	338	Waldmann tijera para cirugía.....	64
tijera vascular.....	59-61	tubo de aspiración Poole.....	27	Walker-Thomson separador vesical.....	552
tijera vascular DeBakey.....	61	tubo de aspiración Pynchon-Andrew.....	28	Wallich cucharilla para aborto.....	607
tijera vascular DeMartel-Potts.....	59	tubo de aspiración Rosen.....	338	Walsham pinza para enderezar el tabique nasal.....	449
tijera vascular Dietrich.....	60	tubo de aspiración Yankauer.....	27	Walther cateter.....	555
tijera vascular Favalaro.....	61	tubo de aspiración Yankauer-Baby.....	27	Walther sonda metálica.....	555
tijera vascular Kelly.....	61	tubo de aspiración Yankauer-Baby.....	27	Walton gubia para cuerpos extraños.....	374
tijera vascular Potts-DeMartel.....	59	tubo de aspiración Yasargil.....	337/1	Walton saca comedones.....	608
tijera vascular Potts-Smith.....	61	tubo de extensión Bruenings.....	472	Walton siera para abrir anillos.....	297
tijera vascular Smith-Potts.....	61	Tucker-Luikart-McLean forceps obstétrico.....	603/1	Wangensteen pinza de disección.....	89
tijera vasija Satinsky.....	65/2	Tuffier pinza hemostática.....	110	Wangensteen porta aguja.....	210
tijera Wagner.....	67	Tuffier separador.....	147	Wartenberg sensímetro.....	25
Tilley pinza auricular.....	411	Tuffier separador costal.....	487	Watson dermatomo.....	50
tirabuzón para fibroma Doyen.....	594	Turnbull alicata para cortar uñas.....	609	Watson-Cheyne disecador.....	199
Tischler-Down pinza para biopsia.....	591	Turrel pinza para biopsia rectal.....	567	Watson-Cheyne elevador.....	283
Tischler-Kevorkian pinza para biopsia.....	592	Tyding amigdalotomo.....	469	Watson-Williams pinza nasal.....	428
Tischler-Morgan pinza para biopsia.....	590, 591	Tyding pinza para coger amígdalas.....	468	Watt-Stone manguito de cierre.....	545
Tischler-Up pinza para biopsia.....	591			Watt-Stone pinza intestinal.....	545
Tobold baja-lengua.....	453	U		Waugh pinza de disección.....	83
Tobold porta-algodón.....	203	U.S. Kirschner estribo para extensión.....	312	Wavecuc tijera para ligaduras.....	54
Todd-Wadsworth cauterio.....	378	Uckermann porta-algodón.....	203	Weber asa.....	378
Toennis elevador para duramadre.....	332	Ulrich pinza para hueso.....	248	Weber pinza para la aorta.....	501
Toennis pinza hemostática.....	117	Ulrich pinza para tapones.....	135	Webster porta aguja.....	208
Toennis-Adson tijera.....	65	Uni I estuche de diagnóstico / otoscopio.....	13	Wecker espátula para iris.....	378
Toennis-Olivcrona pinza aplicadora.....	326	Uni II estuche de diagnóstico/ oftalmoscopio May.....	14	Wecker tijera para iris.....	75
Tohoku pinza de campo.....	132	Uni III estuche de diagnóstico.....	15	Week blefarostato.....	370
tonómetro Schioetz.....	394/2	Universal pinza para esterilización.....	227	Weil-Blakesley pinza nasal.....	426
Took cuchillo corneal.....	373	Universal tijera para alambre y láminas.....	67	Weiss-Dupuy aguja para sutura amígdalas.....	466
torniquete pneumático.....	295	Universal tijera para vendaje.....	70	Weitlaner separador.....	169
tournoi que Belmont-Rumel.....	528	Universal trocar.....	204	Weitlaner-Wullstein separador.....	169
tournoi que Rumel-Belmont.....	528	Unna saca comedones.....	608	Weller tijera de disección.....	53/2
Townley calibre.....	26	Up-Mini-Townsend pinza para biopsia.....	591	Wells espátula para enucleación.....	378
Townsend pinza para biopsia.....	591	Up-Tischler pinza para biopsia.....	591	Wells-Spencer pinza hemostática.....	109

Wertheim pinza para histerectomia.....	124, 128	Zielke gubia .....	264
Wertheim tijera ginecologica .....	63		
Wertheim-Cullen pinza para histerectomia .....	125		
West cincel nasal .....	442/1		
Westcott tijera para tendon .....	75		
Westmacott pinza nasal .....	424		
Wheeler cuchillo para discision .....	373		
Wheeler espátula para ciclodialisis .....	379		
White pinza para coger amígdalas.....	467		
Wieder baja-lengua .....	452		
Wiener escofina nasal .....	443		
Wiener gancho para iris .....	375		
Wigmore cuchillo para vendajes enyesados.....	229		
Wikstroem pinza hemostatica .....	117		
Wilde (Troeltsch) pinza auricular.....	410		
Wilde cierra-nudo auricular .....	411		
Wilde polipotomo .....	433/2		
Wilder asa .....	378		
Wilder dilatador lacrimal.....	381		
Williams destornillador .....	323		
Willet Martel pinza hemostatica .....	110		
Williams blefarostato .....	370		
Williams pinza para tejido .....	539		
Williams-Watson pinza nasal.....	428		
Williger cucharilla cortante.....	255, 257		
Williger martillo .....	271		
Williger periestotomo .....	276		
Winter pinza para aborto.....	606		
Wittner pinza para biopsia .....	589		
Wolff pinza para arrancar vendaje enyesado .....	233		
Wolfson-DeMartel pinza para anastomosis .....	546		
Wolfson-DeMartel pinza para cerrar clamps .....	546		
Wolfson-DeMartel porta-clamps .....	546		
Wood-Crile porta aguja .....	209		
Woodson elevador para duramadre.....	333		
Worst sonda lacrimal.....	381		
Wrigley forceps obstetrico .....	602		
Wulstein cuchillo.....	418		
Wulstein mango de aspiracion .....	338		
Wulstein pinza auricular micro .....	416		
Wulstein separador.....	171		
Wulstein-Hartmann pinza para polipos .....	412		
Wulstein-Weitlaner separador .....	169		
Wylie dilatador uterino.....	581		
Wylie pinza para la aorta .....	501/1, 501/2		
<b>Y</b>			
Yancoskie separador.....	198		
Yankauer elevador para amígdalas .....	465		
Yankauer tubo de aspiracion .....	27		
Yankauer-Baby tubo de aspiracion .....	27		
Yasargil clips para aneurisma .....	345-356		
Yasargil gancho para galea .....	330		
Yasargil pinza para tumores .....	97		
Yasargil tubo de aspiracion.....	337/1		
Yeoman cierra-nudo rectal .....	566		
Yeoman pinza para biopsia rectal .....	566, 567		
Young Boomerang aguja .....	220		
Young Boomerang porta aguja .....	220		
Young pinza de agarre para prostata.....	550		
Young pinza tira-lengua.....	453		
Young separador prostático.....	550		
<b>Z</b>			
Zaufal elevador auricular .....	409		
Zaufal-Jansen elevador auricular .....	409		
Zaufal-Jansen pinza gubia.....	238		
Zenker pinza hemostatica .....	118		
Zenker separador .....	161		
Ziegler blefarostato.....	371		
Ziegler cuchillo para discision.....	373		
Ziegler cuchillo para iris .....	372		
Ziegler dilatador lacrimal .....	381		

ADENOTOMO LA FORCE.....	450	AGO, KOENIG.....	223	AXENFELD CURETTA DA CALAZIO.....	377
AGRAFES, MICHEL.....	224	AGO, REVERDIN.....	220	AYER PINZA PER CALAZIO.....	393
ABBASSALINGUA.....	451	AGO, ROSEN.....	419		
ABBASSALINGUA DAVIS-BOYLE.....	455	AGO, YOUNG-BOOMERANG.....	220	<b>B</b>	
ABBASSALINGUA DOUGHTY.....	458	ALAN-PARKS DIVARICATORE ANALE.....	561	BABCOCK PINZA PER AFFERRARE INTESTINI.....	539
ABBASSALINGUA RUSSEL-DAVIS.....	458	ALDERDYCE ELEVATORE.....	282	BABINSKI MARTELLO DA PERCUSSIONE.....	24
ABBASSALINGUA, ANDREW.....	452	ALESATORE PER FEMORE, KUENTSCHER.....	321	BABY BURKE PINZA PER BIOPSIA.....	590
ABBASSALINGUA, BRUENINGS.....	451	ALESATORE PER L'APERTURA DEL MIDOLLO, KUENTSCHER.....	321	BABY GOSSET DIVARICATORE ADDOMINALE.....	181
ABBASSALINGUA, BUCHWALD.....	451	ALEXANDER PERIOTOTOMO.....	276	BABY METZENBAUM SUPERCUT FORBICI.....	71
ABBASSALINGUA, DINGMANN.....	456	ALEXANDER PINZA PER BIOPSIA.....	589	BABY TISCHLER PINZA PER BIOPSIA.....	592
ABBASSALINGUA, FRENZEL.....	451	ALEXANDER SCALPELLO.....	259	BABY WEBSTER PORT'AGHI.....	208
ABBASSALINGUA, HARTMANN.....	452	ALEXANDER SGORBIA.....	259	BABY YANKAUER CANNULA D'ASPIRAZIONE.....	27
ABBASSALINGUA, KILNER-DOUGHTY.....	456	ALGESIMETRO, WARTENBERG.....	25	BABY-KOCHER PINZA INTESTINALE.....	540
ABBASSALINGUA, KROENIG.....	451	ALLEN PINZA PER L'APPENDICE.....	544	BABY-OLSEN-HEGAR PORT'AGHI.....	212
ABBASSALINGUA, MAYO.....	451	ALLIS PINZA PER AFFERRARE INTESTINI.....	537	BABYPHON SFGIMOMANOMETERO.....	10
ABBASSALINGUA, MORITZ-SCHMIDT.....	452	ALLIS-ADAIR PINZA PER AFFERRARE INTESTINI.....	537	BACINELLA.....	619, 620
ABBASSALINGUA, TOBOLD.....	453	ALLIS-BABY PINZA PER AFFERARE INTESTINI.....	537	BACINELLA PER PLACENTA.....	621
ABBASSALINGUA, WIEDER.....	452	ALM DIVARICATORE.....	168	BACINELLA RENIFORMA.....	619
ABRAHAM COLTELLO PER TONSILLE.....	466	ALVIS CURETTA PER CORPI ESTRANEI.....	374	BACKHAUS PINZA FISSATELI.....	132
ABRAHAM PINZA PER TONSILLE.....	468	AMNIOSCOPO.....	601	BAILEY APPROSSIMATORE COSTALE.....	489
ACCESSORI DI FISSAZIONE, ANELLI E BARRE.....	195	AMNIOTOMO, BEACHAM.....	586	BAILEY-BABY APPROSSIMATORE COSTALE.....	489
ACCESSORI PER SEGA PER AUTOPSIA.....	231/2, 231/3	ANDERSON ADSON DIVARICATORE.....	172	BAILEY-GIBBON APPROSSIMATORE COSTALE.....	489
ADATTATORE DI ILLUMINAZIONE.....	601	ANDREW ABASSALINGUA.....	452	BAINBRIDGE PINZA EMOSTATICA.....	119/2
ADLERKREUTZ PINZA VASCOLARE.....	84	ANDREW-PYNCHON TUBO D'ASPIRAZIONE.....	28	BAINBRIDGE PINZA VASCOLARE.....	495
ADSON DIVARICATORE.....	173	ANELLI DI GOMMA PER LEGATURA.....	568	BAKES DILATATORE BILIARE.....	532
ADSON PINZA ANATOMICA.....	82	ANOSCOPO, HIRSCHMANN.....	562	BALFOUR BABY DIVARICATORE ADDOMINALE.....	182
ADSON PINZA ANATOMICA.....	82	ANSA AURICOLARE, BILLEAU.....	409	BALFOUR DIVARICATORE ADDOMINALE.....	182
ADSON PINZA CHIRURGICA.....	82	ANSA AURICOLARE, SHAPLEIGH.....	410	BALFOUR DIVARICATORE ADDOMINALE.....	183
ADSON BABY PINZA EMOSTATICA.....	113	ANSA PER CATERATTA, ARLT.....	378	BALFOUR-US DIVARICATORE ADDOMINALE.....	184
ADSON DIVARICATORE.....	172	ANSA PER CATERATTA, SNELLEN.....	378	BALL AND SOCKET PINZA FISSATELI.....	133
ADSON MICRO PINZA ANATOMICA.....	82	ANSA PER CATERATTA, WEBER.....	378	BALLENGER COLTELLO PER SETTO.....	436
ADSON MICRO PINZA CHIRURGICA.....	82	ANSA PER CATERATTA, WILDER.....	378	BALLENGER ELEVATORE PER SETTO.....	439
ADSON PERIOTOTOMO.....	282	ANSA PER POLIPI.....	411	BALLENGER PINZA PER TONSILLE.....	467
ADSON PINZA EMOSTATICA.....	112	ANSE PER TONSILLE.....	468	BANE-HARTMANN PINZA SGORBIA.....	237
ADSON PINZA PER IPOFISI.....	334	ANTRUM-CURETTA.....	435	BANGERTER SPATOLA PER CICLODIALISI.....	379
ADSON PINZA SGORBIA.....	236	ANVIL TRONCHESINA PER UNGHIE.....	613	BARACANI INSERTO.....	472
ADSON PORT'AGHI.....	211	APPARECCHIATURA DI SUTURA GASTRO-INTESTINALE, V.PETZ.....	549	BARANY ASSORDITORE.....	405
ADSON TENAGLIA PER OSSA.....	298	APPROSSIMATORE COSTALE, BAILEY.....	489	BARBARA AGO.....	419
ADSON TUBO D'ASPIRAZIONE.....	337	APPROSSIMATORE COSTALE, BAILEY-BABY.....	489	BARBARA UNCINO.....	419
ADSON UNCINO PER DURAMADRE.....	329	APPROSSIMATORE COSTALE, BAILEY-GIBBON.....	489	BARKAN COLTELLO PER GONIOTOMIA.....	373
ADSON, DIVARICATORE.....	174	APPROSSIMATORE, BIEMER.....	366	BARNHILL COLTELLO ADENOIDE.....	450
ADSON-BROWN PINZA CHIRURGICA.....	82	APPROSSIMATORE, BIEMER-MÜLLER.....	363	BARON CANNULA D'ASPIRAZIONE.....	336
AEBLI FORBICI PER OFTALMOLOGIA.....	58	APRIBOCCA DI LEGNO MAUNDER.....	459	BARR SPECULO RETTALE.....	559
AGHI PER SUTURE.....	222, 223	APRIBOCCA, DAVIS-BOYLE.....	455	BARRAQUER (COLIBRI) PINZA PER IRIDE.....	384
AGO PER BIOPSIA,FRANKLIN-SILVER.....	206	APRIBOCCA, DAVIS-MEYER.....	457	BARRAQUER BLEFAROSTATO.....	370
AGO DI GUIDA, IOWA.....	206	APRIBOCCA, DENHART,12CM.....	454	BARRAQUER COLTELLO PER CHERATOPLASTICA.....	373
AGO DI GUIDA, REDON.....	207	APRIBOCCA, DINGMANN.....	456	BARRAQUER FORBICI OCULISTICHE.....	75
AGO DI INTRODUZIONE, OBWEGESER.....	463	APRIBOCCA, HEISTER.....	454	BARRAQUER PINZA DA FISSAZIONE.....	390
AGO DI INTRODUZIONE, OBWEGESER.....	463/3	APRIBOCCA, JENNINGS.....	454	BARRAQUER PINZA DEPILETORIA.....	395
AGO PASSAFILI, DEMEL.....	315	APRIBOCCA, KILNER-DOUGHTY.....	456	BARRAQUER PORT'AGHI.....	216, 217
AGO PER CORPI ESTRANEI.....	374	APRIBOCCA, MCIVOR.....	457	BARRAQUER-KATZIN PINZA PER IRIDE.....	384
AGO PER CORPI ESTRANEI, DAVIS.....	374	APRIBOCCA, ROSER-KOENIG 16CM.....	454	BARRAQUER-TROUTMAN PORT'AGHI.....	216
AGO PER CORPI ESTRANEI, FRANCIS.....	374	APRIBOCCA,DOYEN-JANSEN(MOLT).....	454	BARRET PINZA PER ABBASSARE IL COLLO DELL'UTERO.....	582
AGO PER CORPI ESTRANEI, LA FORCE.....	374	ARCHER PINZA PER SCHEGGE.....	92	BARTON FORCIPE.....	603
AGO PER CORPI ESTRANEI, LEVINSON.....	374	ARCO PER ESTENSIONE, BOEHLER.....	312	BARTON TRATTORE.....	603
AGO PER DISCISIONE.....	374	ARCO PER ESTENSIONE, KIRSCHNER.....	312	BAUMGARTNER PORT'AGHI.....	208
AGO PER DISCISIONE, BOWMAN.....	374	ARCO PER ESTENSIONE, KIRSCHNER US.....	312	BEACHAM AMNIOTOMO.....	586
AGO PER INSUFFLAZIONE, VERESS.....	206	ARLT ANSA PER CATERATTA.....	378	BECHERT ROTATORE PER NUCLEO.....	379
AGO PER LEGATURE.....	218	ARRUGA BLEFAROSTATO.....	370	BECK PINZA PER ANASTOMOSI.....	520
AGO PER LEGATURE SCHMIEDEN-DICK.....	219	ARRUGA CUCCHIAIO PER ASPORTAZIONE RETINALE.....	378	BECK PINZA VASCOLARI.....	516
AGO PER LEGATURE, COOPER.....	219			BECKER CISTOTOMO.....	375
AGO PER LEGATURE, DESCHAMPS.....	218	ARRUGA PINZA CAPSULARE.....	391	BECKMANN COLTELLO ADENOIDE.....	450
AGO PER LEGATURE, KRONECKER.....	219	ARRUGA PORT'AGHI.....	214	BECKMANN DIVARICATORE.....	176
AGO PER LEGATURE, NELSON.....	219	ARRUGA UNCINO ESTRATTORE.....	375	BECKMANN-ADSON DIVARICATORE.....	175
AGO PER PARACENTESI, LUCAE.....	408	ASCH PINZA PER LA PLASTICA NASALE.....	449	BECKMANN-EATON DIVARICATORE.....	176
AGO PER PARACENTESI, POLITZER.....	408	ASSORDITORE, BARANY.....	405	BEEBEE FORBICI PER CORONA.....	68
AGO PER TONSILLE.....	470	AUFBRANC-COBRA DIVARICATORE.....	289	BEER PINZA DEPILETORIA.....	395
AGO PER TONSILLE, CLAUS.....	466	AUFRICHT RASPA NASALE.....	443	BEESON DIVARICATORE PER GESSI.....	232
AGO PER TONSILLE, DUPUY-WEISS.....	466	AUFRICHT UNCINO NASALE.....	447	BEESON DIVARICATORE PER GESSI.....	232
AGO PER TONSILLE, NAGER.....	466	AUVARD SPECULO VAGINALE.....	576	BELLUCCI MICRO FORBICI AURICOLARI.....	413
AGO POST MORTEM.....	268			BELLUCCI MICRO FORBICINE.....	417
AGO, BARBARA.....	419			BENDA PER COMPRESIONE ESMARCH.....	297
AGO, KEITH.....	223				



BENDER MODELLATORE PER CHIODI.....	322	BOYNTON PORT'AGHI.....	214	CANNULA D'ASPIRAZIONE PER BIOPSIA, BUIE.....	566
BENGOLEA PINZA EMOSTATICA.....	112	BOZEMANN PINZA PER TAMPONI.....	138	CANNULA D'ASPIRAZIONE POOLE.....	27
BENNETT ELEVATORE PER OSSA.....	283	BOZEMANN PORT'AGHI.....	211	CANNULA D'ASPIRAZIONE ZÖLLNER.....	337/1
BENSAUDE PROCTOSCOPO.....	565	BOZEMANN-DOUGLAS PINZA PER TAMPONI.....	138	CANNULA D'ASPIRAZIONE, ADSON.....	337
BENSON DIVARICATORE PER PILORO.....	544	BRACCIALE.....	295	CANNULA D'ASPIRAZIONE, ANDREW-PYNCHON.....	28
BERENS CHERATOMO.....	372	BRACCIO PORTALAREINGOSCOPIO KLEINSASSER.....	36	CANNULA D'ASPIRAZIONE, BABY-YANKAUER.....	27
BERGMANN FORBICI PER BENDAGGI.....	69/1	BRAND ENUCLEATORE PER TENDINI.....	294	CANNULA D'ASPIRAZIONE, COOLEY.....	28
BERGMANN MARTELLO.....	272	BRAND STRUMENTI PER AFFERRARE TENDINI.....	293	CANNULA D'ASPIRAZIONE, DE BAKEY.....	28
BERKE PINZA MUSCOLARE.....	389	BRAUN CRANIOCLASTO.....	607	CANNULA D'ASPIRAZIONE, FERGUSSON.....	337
BERLINER MARTELLO DA PERCUSSIONE.....	24	BRAUN DEPRESSORE UTERINO.....	586	CANNULA D'ASPIRAZIONE, FRAZIER/FERGUSSON.....	337
BERNHARD PINZA FISSATELI.....	133	BRAUN PINZA PER ABBASSARE IL COLLO		CANNULA D'ASPIRAZIONE, PLESTER.....	338
BERRY PINZA TORCIFILI.....	319	DELL'UTERO.....	582	CANNULA D'ASPIRAZIONE, ROSEN.....	338
BETHUNE COSTOTOMO.....	481	BRAUN UNCINO SPEZZATORE.....	607	CANNULA D'ASPIRAZIONE, YASARGIL.....	337/1
BICCHIERE GRADUATO.....	620	BRAUN-STADLER FORBICI PER EPISIOTOMIA.....	64	CANNULA D'ASPIRAZIONE, HOUSE.....	337/2
BICCHIERE PER MEDICINALI.....	621	BREAST DIVARICATORE PER CHIRURGIA PLASTICA.....	198	CANNULA LARINGEA.....	470
BIEMER APPROSSIMATORE.....	366	BREISKY SPECOLO VAGINALE.....	577	CANNULA OCULISTICA JENSEN.....	394
BIEMER CLIPS PER VASI.....	361	BRIDGE PINZA EMOSTATICA.....	116	CANNULA OCULISTICA MCINTYRE.....	394
BIEMER PINZA POSA CLIPS.....	361, 363, 364, 366	BRISTOW ELEVATORE PER OSSA.....	290	CANNULA OCULISTICA PER IRRIGAZIONE ED	
BIEMER-MÜLLER APPROSSIMATOR.....	363	BRODIE SPECILLO.....	199	ASPIRAZIONE BISHOP-HARMON.....	394/1
BIER SEGA PER AMPUTAZIONE.....	296	BROPHY PINZA ANATOMICA.....	84	CANNULA OCULISTICA, LACRIMAL.....	394
BILL TRATTORE.....	604	BROPHY PINZA CHIRURGICA.....	84	CANNULA PER ASPIRAZIONE GUILLEN.....	433/1
BILLEAU ANSA AURICOLARE.....	409	BROWN PINZA PER TESSUTI.....	83	CANNULA PER BIOPSIA, MENGHINI.....	206
BIRCHER-GANSKE TENAGLIA PER OSSA.....	246	BROWN PORT'AGHI.....	209	CANNULA PER IRRIGAZIONE KILLIAN.....	433, 433/1
BIRKETT PINZA EMOSTATICA.....	116	BRUENINGS COLTELLO PER TONSILLE.....	466	CANNULA PER IRRIGAZIONE SHEETS.....	394/2
BISHOP-HARMAN PINZA PER IRIDE.....	386	BRUENINGS ABBASSALINGUA.....	451	CANNULA PER IRRIGAZIONE, HARTMANN.....	433
BISHOP-HARMON CANNULA OCULISTICA PER		BRUENINGS INSERTO.....	472	CANNULA PER IRRIGAZIONE, SCHMID.....	338
IRRIGAZIONE ED ASPIRAZIONE.....	394/1	BRUENINGS PINZA PER SETTO NASALE.....	425	CANNULA PER IRRIGAZIONE, SIMBENN.....	433
BISTURI MONOUSO, STERILI.....	43	BRUENINGS SPECOLO AURICOLARE.....	401	CANNULA PER IRRIGAZIONE, SMCOE.....	394
BISTURI PER FIBROMI, SEGOND.....	594	BRUNETTI SCALPELLO.....	268	CANNULA TRACHEALE, LUER.....	479
BISTURI, MANICO DI METALLO.....	46	BRÜNING-LUCAS SCALPELLO.....	260	CANNULA TRACHEALE, WAGENER-MOSHER.....	477
BLAKE CURETTA UTERINA.....	595	BRÜNING-LUCAS SCALPELLO.....	260	CANNULA TRACHEALE, CHEVALIER-JACK.....	479
BLAKE PINZA PER CALCOLI BILIARI.....	531	BRÜNING-LUCAS SGORBIA.....	260	CANNULA, LICHTWITZ.....	433
BLEFAROSTATO CLARK.....	370	BRUNNER COSTOTOMO.....	481	CAPLAN PINZA NASALE.....	428
BLEFAROSTATO LIEBERMANN.....	371	BRUNNER DIVARICATORE.....	167	CARMALT PINZA PER SCHEGGE.....	91
BLEFAROSTATO, ARRUGA.....	370	BRUNNER PINZA INTESTINALE.....	543	CAROLL PINZA PER AFFERRARE TENDINI.....	293
BLEFAROSTATO, BARRAQUER.....	370	BRUNNER SONDE CONDUITTRICE.....	221	CARPENTER COLTELLO PER TONSILLE.....	465
BLEFAROSTATO, BOWMAN.....	370	BRUNNER SONDE CONDUITTRICE.....	221	CASPAR DIVARICATORE PER SPINA CERVICALE.....	179
BLEFAROSTATO, CASTROVIEJO.....	371	BRUNS CURETTA TAGLIANTE.....	251, 254	CASPAR DIVARICATORE PER SPINA CERVICALE.....	180
BLEFAROSTATO, CRITCHETT.....	370	BRUNS FORBICI PER BENDAGGI.....	70	CASPAR PISTONI.....	258
BLEFAROSTATO, GRAEFE.....	370	BRYANT PINZA PER MEDICATURA.....	137	CASTANEDA NEONATAL PINZA VASCOLARE.....	527
BLEFAROSTATO, LANCASTER.....	371	BUCHWALD ABBASSALINGUA.....	451	CASTROVIEJO BLEFAROSTATO.....	371
BLEFAROSTATO, LISTER-BURCH.....	370	BUCK CURETTA AURICOLARE.....	407	CASTROVIEJO COLTELLO LANCEOLARE.....	372
BLEFAROSTATO, MELLINGER.....	370	BUCK LEVA PER CORPI ESTRANEI.....	412	CASTROVIEJO COMPASSO.....	380
BLEFAROSTATO, MELLINGER-AXENFELD.....	370	BUCK MARTELLO DA PERCUSSIONE.....	24	CASTROVIEJO FORBICI CORNEALI.....	79
BLEFAROSTATO, MUELLER.....	371	BUCK-GRAMCKO ELEVATORE PER OSSA.....	285	CASTROVIEJO PINZA CAPSULARE.....	391
BLEFAROSTATO, MURDOCK.....	370	BUE CANNULA D'ASPIRAZIONE RETTALE.....	566	CASTROVIEJO PINZA FISSATRICE.....	390
BLEFAROSTATO, PARK.....	371	BULLDOG PINZA MINI DIETRICH.....	101	CASTROVIEJO PINZA PER SUTURA.....	392
BLEFAROSTATO, SMITH.....	370	BULLDOG PINZA, JOHNS-HOPKINS.....	104	CASTROVIEJO PORT'AGHI.....	215
BLEFAROSTATO, STEVENSON.....	371	BULLDOG PINZE ATTRAUMATICHE.....	100	CASTROVIEJO ROMPIAMETTE.....	45
BLEFAROSTATO, WEEK.....	370	BÜLOW-GUNAR-HEY PINZA SERRATUBI A RULLI.....	130	CASTROVIEJO SPATOLA PER CICLODIALISI.....	379
BLEFAROSTATO, WILLIAMS.....	370	BUMM CURETTE UTERINI.....	597	CASTROVIEJO-MICRO PORT'AGHI.....	215
BLEFAROSTATO, ZIEGLER.....	371	BUNELL ENUCLEATORE PER TENDINI.....	292	CASTROVIEJO-STANDARD PORT'AGHI.....	216
BLOHMKE PINZA PER TONSILLE.....	467	BUNELL GUIDA PER TENDINI.....	294	CATETERE AURICOLARE, HARTMANN.....	408
BLOUNT ELEVATORE PER GINOCCHIO.....	289	BUNELL PERFORATORE A MANO.....	299	CATETERE METALLICO.....	555
BLOUNT ELEVATORE PER OSSA.....	288	BUNGE CUCCHIAIO PER ESTENTERAZIONE.....	378	CATETERE METALLICO, COXETER.....	555
BLUMENTHAL PINZA SGORBIA.....	236	BUNT PINZA PER STERILIZZAZIONE.....	227	CATLUN AMPUTATIONSMESSN.....	44
BODENHAMMER SPECOLO RETTALE.....	559	BURCH UNCINO DI FISSAZIONE.....	373	CAUTERIO WADSWORTH-TODD.....	378
BOEHLER ARCO PER ESTENSIONE.....	312	BURKE PINZA PER BIOPSIA.....	590	CAVO BIPOLORE.....	633
BOERMA FORCIPE.....	604	BUSHE CURETTA TAGLIANTE.....	256	CESIOIA PER GESSI, STILLE.....	229
BOETTCHER FORBICI PER TONSILLE.....	59			CESIOIA PER OSSA STILLE-HORSLEY.....	242
BÖHLER CESIOIA PER OSSA.....	241	<b>C</b>		CESIOIA PER OSSA STILLE-LISTON.....	242
BÖHLER PINZA SGORBIA.....	238	CACCIAVITE WILLIAMS.....	323	CESIOIA PER OSSA, BOEHLER.....	241
BOIES ELEVATORE.....	277	CACCIAVITE, LANE.....	323, 324	CESIOIA PER OSSA, LISTON.....	241
BONACCOLTO PINZA PER STRABISMO.....	385	CALAMITA OCULISTICA, REDA.....	395	CESIOIA PER OSSA, MCINDOE.....	241
BONN PINZA PER IRIDE.....	387	CALIBRO.....	26	CESIOIA PER OSSA, RUSKIN-LISTON.....	241
BONNEY PINZA ANATOMICA.....	88	CAMERA D'ARIA.....	295	CESIOIA PER OSSA, SEMB.....	242
BONNEY PINZA CHIRURGICA.....	88	CANDELETTA DILATATRICE, DITTEL.....	554	CESIOIA PER OSSA, COTTLE-K.....	241
BOSE DIVARICATORE TRACHEALE.....	476	CANDELETTA DILATATRICE, GUYON.....	554	CESTELLO.....	623
BOUCHERON SPECOLO AURICOLARE.....	399	CANDELETTA DILATATRICE, VAN BUREN.....	554	CESTELLO PER ENDOSCOPI.....	623
BOWMAN AGO PER DISCISIONE.....	374	CANFIELD COLTELLO PER TONSILLE.....	466	CESTELLO PER STERILIZZAZIONE.....	622
BOWMAN BLEFAROSTATO.....	370	CANNULA DA INIEZIONE.....	36	CHANDLER ELEVATORE.....	282
BOWMAN CHERATOMO.....	372	CANNULA D'ASPIRAZIONE.....	337/1	CHAPUT PINZA PER AFFERRARE TESSUTI.....	110
BOWMAN SPECILLO PER CANALE LACRIMALE.....	381	CANNULA D'ASPIRAZIONE KLEINSASSER.....	36	CHARNLEY DIVARICATORE ADDOMINALE.....	289

CHARRIERE SEGA PER AMPUTAZIONE.....	296	COLTELLO PER AMPUTAZIONE, CATLIN.....	44	CORONAL BLOW DIVARICATORE PER CHIRURGIA PLASTICA.....	198
CHEATLE PINZA PER STERILIZZAZIONE.....	227	COLTELLO PER AMPUTAZIONE, LANGENBECK.....	44	CORWIN-HEGAR PINZA TORCIFILI.....	319
CHELSEA-EATON PROCTOSCOPO.....	563	COLTELLO PER AMPUTAZIONE, REDA.....	44	CORYLLOS COSTOTOMO.....	480
CHERON PINZA PER MEDICATURA.....	137	COLTELLO PER CARTILAGINE E DISSEZIONE, VIRCHOW.....	48	CORYLLOS DIVARICATORE.....	166
CHERRY DIVARICATORE PER LAMINECTOMIA.....	488	COLTELLO PER CARTILAGINI, LANGENBECK.....	47	COS MIKRO-PINZA AURICOLARE.....	414
CHEVALIER-JACKSON CANNULA TRACHEALE.....	479	COLTELLO PER CATARATTA, DEUTSCHMANN.....	371	COSCIALE.....	295
CHEVALIER-JACKSON PINZA PER BRONCO-ESOFAGOSOFIA.....	473	COLTELLO PER CATARATTA, GRAEFE.....	371	COSTOTOMO.....	480
CHIAVE.....	266	COLTELLO PER CERVELLO.....	48	COSTOTOMO SAUERBRUCH-FREY.....	481
CHIAVI.....	313	COLTELLO PER CHERATOPLASTICA, BARRAQUER.....	373	COSTOTOMO, BETHUNE.....	481
CHILDE PINZA PER AGRAFES.....	224	COLTELLO PER CHERATOPLASTICA, PAUFIQUE.....	373	COSTOTOMO, BRUNNER.....	481
CHIODI PER OSSA.....	309	COLTELLO PER DURA MADRE, KOOS.....	335	COSTOTOMO, CORYLLOS.....	480
CHIODI STEINMANN.....	307, 308	COLTELLO PER FALANGI.....	44	COSTOTOMO, GIERTZ-STILLE.....	481
CINELLI SCALPELLO PER SETTO.....	441	COLTELLO PER GESSI, ESMARCH.....	233	COSTOTOMO, GLUCK.....	480
CISTOTOMO, BECKER.....	375	COLTELLO PER GESSI, HOPKINS.....	233	COSTOTOMO, SAUERBRUCH.....	481
CISTOTOMO, GRAEFE.....	375	COLTELLO PER GESSI, REINER.....	233	COSTOTOMO, STILLE.....	480
CITELLI PINZA TAGLIANTE PER SETTO NASALE.....	430	COLTELLO PER GESSI, WIGMORE.....	229	COTTLE COLUMELLA PINZA.....	448
CLAR LAMPADA FRONTALE.....	22	COLTELLO PER GONIOTOMIA, BARKAN.....	373	COTTLE BULLDOG-FORBICI.....	56
CLARK BLEFAROSTATO 8CM.....	370	COLTELLO PER GONIOTOMIA, SCHEIE.....	373	COTTLE COLTELLO NASALE.....	435
CLAUS AGO PER TONSILLE.....	466	COLTELLO PER IRIDE, DEAN.....	372	COTTLE ELEVATORE PER SETTO.....	439
CLAYMAN UNCINO.....	376	COLTELLO PER IRIDE, KNAPP.....	372	COTTLE FORBICI NASALI.....	59
CLEVELAND PINZA SGOBRIA.....	235	COLTELLO PER IRIDE, ZIEGLER.....	372	COTTLE MARTELLO.....	273
CLIPS PER ANEURISMA YASARGIL.....	345-356	COLTELLO PER MENISCO, NEFF.....	292	COTTLE PINZA DA PRESA.....	410
CLIPS PER VASI, BIEMER.....	361	COLTELLO PER MENISCO, SMILLIE.....	292	COTTLE SCALPELLO PER SETTO.....	440
CLIPS PER VASI, MEHDORN.....	362	COLTELLO PER ORGANI.....	48	COTTLE SPECOLO NASALE.....	423
CLIPS PER VASI, MUELLER.....	364, 365	COLTELLO PER PERIOSTIO CON RASCHINO.....	47	COTTLE UNCINO NASALE.....	447
CLOWARD DIVARICATORE.....	178	COLTELLO PER RESEZIONE.....	47	COTTLE-JOSEPH ELEVATORE PER SETTO.....	439
CLOWARD DIVARICATORE PER CORPI VERTEBRALI.....	339	COLTELLO PER SETTO NASALE, FREER.....	434	COTTLE-KAZANJIAN CEOJIA PER OSSA.....	241
CLOWARD PINZA TAGLIANTE PER LAMINECTOMIA.....	342	COLTELLO PER SETTO, BALLENGER.....	436	COTTLE-NEIVERT UNCINO NASALE.....	448
COAKLEY ANTRUM CURETTA.....	449	COLTELLO PER TONSILLE, ABRAHAM.....	466	COXETER CATETERE METALLICO.....	555
COAKLEY TREQUARTO PER SENO MASCELLARE.....	204	COLTELLO PER TONSILLE, BRUENINGS.....	466	CRAFOOD-SELLORS PINZA EMOSTATICA.....	119
COBB CURETTA.....	252	COLTELLO PER TONSILLE, CANFIELD.....	466	CRAFOOD FORBICI POLMONARE.....	65/2
COBB PERIOSTOTOMO.....	280	COLTELLO PER TONSILLE, CARPENTER.....	465	CRAFOOD PINZA EMOSTATICA.....	118
COBB SGOBRIA.....	262	COLTELLO PER TONSILLE, DOUGLAS.....	466	CRANIOCLASTO, BRAUN.....	607
COLCLOUGH PINZA TAGLIANTE PER DISCHI INTERVERTEBRALI.....	344/1	COLTELLO PER TONSILLE, FISHER.....	466	CRANIOCLASTO, TARNIER.....	607
COLLER-CRILE PINZA EMOSTATICA.....	106	COLTELLO, PLESTER.....	418	CREGO ELEVATORE.....	282
COLLIER PELVIMETRO.....	605	COLTELLO, ROSEN.....	418	CRILE DIVARICATORE.....	140
COLLIER PORT'AGHI.....	208	COLTELLO, SCHUKNECHT.....	418	CRILE PINZA EMOSTATICA.....	107
COLLIN DINAMOMETRO.....	25	COLTELLO, TABB.....	418	CRILE PORT'AGHI.....	213
COLLIN DIVARICATORE.....	139	COLTELLO, WULLSTEIN.....	418	CRILE UNCINO PER NERVI.....	328
COLLIN DIVARICATORE ADDOMINALE.....	189/1	COLUMELLA PINZA, COTTLE.....	448	CRILE-MURRAY PORT'AGHI.....	209
COLLIN DIVARICATORE ADDOMINALE.....	190	COLVER PINZA PER TONSILLE.....	467	CRILE-RANKIN PINZA EMOSTATICA.....	107
COLLIN ISTEROMETRO.....	586	COMBINAZIONE PER DIAGNOSTICA CON ILLUMINAZIONE ALOGENA, RI-MINI.....	17	CRILE-WOOD PORT'AGHI.....	209
COLLIN LOKITTE DIVARICATORE ADDOMINALE.....	191	COMBINAZIONE PER DIAGNOSTICA CON ILLUMINAZIONE STANDARD ECO "T".....	16	CRITCHETT BLEFAROSTATO.....	370
COLLIN MARTELLO.....	270	COMBINAZIONE PER DIAGNOSTICA CON ILLUMINAZIONE STANDARD UNI I.....	13	CRUTCHFIELD PERFORATORE.....	327
COLLIN PELVIMETRO.....	605	COMBINAZIONE PER DIAGNOSTICA CON ILLUMINAZIONE STANDARD UNI II.....	14	CRUTCHFIELD PINZA PER TRAZIONE CRANIALE.....	327
COLLIN PINZA OMBELICALE.....	605	COMBINAZIONE PER DIAGNOSTICA CON ILLUMINAZIONE STANDARD UNI III.....	15	CUCCHIAIO AURICOLARE, GROSS.....	409
COLLIN PINZA PER AFFERRARE INTESTINI.....	539	COMPASSO, CASTROVIEJO.....	380	CUCCHIAIO OSTETRICO, SELLHEIM.....	607
COLLIN PINZA PER AFFERRARE L'UTERO.....	585	COMPASSO, IWANSON.....	624	CUCCHIAIO PER ABORTO, CUZZI.....	606
COLLIN PINZA PER AFFERRARE TESSUTI.....	110	COMPRESSORE STONE-WATT.....	545	CUCCHIAIO PER ABORTO, WALLICH.....	607
COLLIN PINZA PER AGRAFES.....	224	CONE PINZA PER CRANIOTOMIA.....	331	CUCCHIAIO PER ASPORTAZIONE RETINALE, ARRUGA.....	378
COLLIN PINZA PER MEDICATURA.....	137	CONNIN-AMSLER MARCATORE.....	380	CUCCHIAIO PER CALCOLI BILIARI MOOR.....	532
COLLIN PINZA TIRILINGUA.....	453	CONVERSE COLTELLO NASALE.....	435	CUCCHIAIO PER CALCOLI BILIARI, DESJARDINS.....	534
COLLIN SPECOLO VAGINALE.....	570	COOLEY DILATATORE.....	528	CUCCHIAIO PER CALCOLI BILIARI, FERGUSON.....	533
COLLIN-DUVAL PINZA DA PRESA.....	85	COOLEY CANNULA D'ASPIRAZIONE.....	519	CUCCHIAIO PER CALCOLI BILIARI, LUER-KOERTE.....	533
COLLIN-HARTMANN DIVARICATORE.....	141	COOLEY DIVARICATORE.....	148	CUCCHIAIO PER CALCOLI BILIARI, MAYO.....	534
COLTELLO ADENOIDE BECKMANN.....	450	COOLEY DIVARICATORE COSTALE.....	487	CUCCHIAIO PER CATERATTA, DAVIEL.....	377
COLTELLO ADENOIDE, BARNHILL.....	450	COOLEY PINZA CARDIOVASCOLARE ATRAUMATICA.....	518, 519, 522	CUCCHIAIO PER CATERATTA, GRAEFE.....	377
COLTELLO ADENOIDE, ST. CLAIR-THOMSON.....	450	COOLEY PINZA PER CATETERI.....	510	CUCCHIAIO PER CATERATTA, KNAPP.....	378
COLTELLO AURICOLARE, POLITZER.....	408	COOLEY-DERRA PINZA PER ANASTOMOSI.....	519	CUCCHIAIO PER CATERATTA, WELLS.....	378
COLTELLO AURICOLARE, SEXTON.....	408	COOLEY-NEONATAL DIVARICATORE COSTALE.....	485	CUCCHIAIO PER ESTENTERAZIONE, BUNGE.....	378
COLTELLO FALCATO REDA.....	435	COOPER AGO PER LEGATURE.....	219	CUCCHIAIO PER MEDICINALI.....	621
COLTELLO INTEROSSEO.....	44	COPERCHIO PER PADELLA.....	621	CUCCHIAIO PER SANGUE.....	268
COLTELLO LANCEOLARE, BERENS.....	372	CORDA DI TRAZIONE.....	201	CUCCHIAIO UTERINO GOURDET.....	599
COLTELLO LANCEOLARE, BOWMAN.....	372	CORDES INSERTO.....	472	CUCCHIAIO UTERINO SCHRÖDER.....	595
COLTELLO LANCEOLARE, CASTROVIEJO.....	372			CUCCHIAIO UTERINO, SIMON.....	594
COLTELLO LANCEOLARE, JAEGER.....	372			CULLER SPATOLA PER IRIDE.....	378
COLTELLO LANCEOLARE, WHEELER.....	373			CURETTA ANTRUM.....	435
COLTELLO LANCEOLARE, ZIEGLER.....	373			CURETTA ANTRUM, COAKLEY.....	449
COLTELLO NASALE, CONVERSE.....	435			CURETTA AURICOLARE, BUCK.....	407
COLTELLO NASALE, COTTLE.....	435			CURETTA COBB.....	252
COLTELLO PER AMPUTAZIONE LISTON.....	44			CURETTA DA CALAZIO, AXENFELD.....	377



CURETTA DA CALAZIO, HEBRA .....	377	DE BAKEY PINZA VASCOLARE .....	493, 494, 495, 496, 497, .....498, 499, 500, 505, 507, 508, 514, 515, 516, 517,	DILATATORE UTERINO PRATT .....	580
CURETTA DA CALAZIO, MEYHOEFER .....	377	DE BAKEY PORT'AGHI .....	210	DILATATORE UTERINO SIMS .....	581
CURETTA PER ABORTO, PESTALOZZA .....	606	DE BAKEY, PINZA ATRAUMATICA BULLDOG .....	100	DILATATORE UTERINO WYLIE .....	581
CURETTA PER BIOPSIA ED ASPIRAZIONE .....	600	DE BAKEY, PINZE ATRAUMATICHE .....	98	DILATATORE VASCOLARE DEBAKEY .....	529
CURETTA PER BIOPSIA, HEANY .....	587	DE BOER DIVARICATORE COSTALE .....	486	DINAMOMETRO, COLLIN .....	25
CURETTA PER BIOPSIA, KEVORKIAN .....	587	DE LEE FORCIPE .....	602	DINGMAN ELEVATORE .....	463/3
CURETTA PER BIOPSIA, MOD.MÜNCHEN .....	587	DE MARTEL STRUMENTO CONDUTTRICE .....	330	DINGMANN ABBASSALINGUA .....	456
CURETTA PER BIOPSIA, NOVAK .....	587	DE MARTEL STRUMENTO CONDUTTRICE .....	330	DINGMANN APRIBOCCA .....	456
CURETTA PER BIOPSIA, RANDALL .....	587	DE MARTEL-WOLFSON PINZA PER ANASTOMOSI .....	546	DINGMANN DIVARICATORE .....	463
CURETTA PER CORPI ESTRANEI ALVIS .....	374	DEAN COLTELLO PER IRIDE .....	372	DINGMANN PERIOSTOTOMO .....	463
CURETTA PER IPOFISI .....	334	DEAN FORBICI PER TONSILLE .....	59	DINGMANN TENAGLIA PER OSSA .....	246
CURETTA PER LUPUS, FOX .....	608	DEAVER DIVARICATORE .....	145	DIPLOMAT SFIGMOMANOMETRO .....	5
CURETTA PER LUPUS, PIFFARD .....	608	DEAVER FORBICI PER DISSEZIONE .....	52	DISSETTORE CORNEALE, PATON .....	373
CURETTA TAGLIENTE BRUNS .....	251, 254	DEAVER-GRIP DIVARICATORE .....	146	DISSETTORE CORNEALE, ELSCHNIG .....	373
CURETTA TAGLIENTE DOPPIA VOLKMANN .....	257	DEBAKEY FORBICI VASCOLARI .....	61	DISSETTORE CORNEALE, GILL .....	373
CURETTA TAGLIENTE VOLKMANN .....	251	DEBAKEY FORBICI VASCOLARI TC .....	60	DISSETTORE CORNEALE, GREEN .....	374
CURETTA TAGLIENTE WILLIGER .....	255	DEBAKEY PINZA PER ANASTOMOSI .....	505	DISSETTORE CORNEALE, SATO .....	373
CURETTA TAGLIENTE, BUSHE .....	256	DEBAKEY-BAHNSON PINZA ANEURISMA .....	506	DISSETTORE CORNEALE, TOOK .....	373
CURETTA TAGLIENTE, DAUBENSPECK .....	255	DEBAKEY-DIETHRICH MINI PINZA BULLDOG .....	101	DISSETTORE CORNEALE, GORNEY .....	277
CURETTA TAGLIENTE, HALLE .....	253	DEBAKEY-MOSQUITO PINZA EMOSTATICA .....	509	DISSETTORE PER SACCO LACRIMALE, LANG .....	378
CURETTA TAGLIENTE, JACOBSON .....	257	DEBAKEY-PEAN PINZA EMOSTATICA .....	513	DISSETTORE PER TONSILLE, HURD .....	465
CURETTA TAGLIENTE, JANSEN .....	257	DEBAKEY-RANKIN PINZA EMOSTATICA .....	512	DISSETTORE PER TONSILLE, LOPEZ-REINKE .....	465
CURETTA TAGLIENTE, LEMPERS .....	256	DEBAKEY-SATINSKY PINZA PER OCCLUSIONE TANGENZIALE .....	502	DISSETTORE PER TONSILLE, YANKAUER .....	465
CURETTA TAGLIENTE, MARTINI .....	257	DEJERINE MARTELLO DA PERCUSSIONE .....	24	DISSETTORE, FISCH .....	420
CURETTA TAGLIENTE, SCHEDE .....	251	DELEE DIVARICATORE .....	574	DISSETTORE, PENFIELD .....	333
CURETTA TAGLIENTE, SCOVILLE .....	253	DEMEI AGO PASSAFILI .....	315	DISTRIBUTORE PER PERFORATORI FILIFORME .....	310
CURETTA TAGLIENTE, SPINAL .....	253	DEMEI STRUMENTO TENDIFILI .....	315	DISTRIBUTORE PER SPAZZOLINI .....	611
CURETTA TAGLIENTE, SPRATT .....	251	DENHART APRIBOCCA .....	454	DITTEL CANDELETTA DILATATRICE .....	554
CURETTA, FAULKNER .....	449	DEKON-BROWNE DIVARICATORE ADDOMINALE .....	185	DIVARICATORE .....	463/3
CURETTA, HOUSE .....	420	DEPRESSORE PER EPIGLOTTIDE, REICHERT .....	471	DIVARICATORE ADDOMINALE BABY GOSSET .....	181
CURETTE UTERINI, BLAKE .....	595	DEPRESSORE UTERINO, BRAUN .....	586	DIVARICATORE ADDOMINALE BALFOUR .....	182
CURETTE UTERINI, BUMM .....	597	DEPRESSORE UTERINO, SIMS .....	586	DIVARICATORE ADDOMINALE BALFOUR .....	183
CURETTE UTERINI, RECAMIER .....	597	DERF PORT'AGHI .....	208	DIVARICATORE ADDOMINALE BALFOUR BABY .....	182
CURETTE UTERINI, SIMS .....	597, 598	DERMATOMO, HUMBY .....	50	DIVARICATORE ADDOMINALE BALFOUR-US .....	184
CURETTE UTERINI, THOMAS .....	599	DERMATOMO, SILVER .....	50	DIVARICATORE ADDOMINALE CHARNELY .....	289
CUSCO SPECOLO VAGINALE .....	570, 571	DERMATOMO, SCHINK .....	49	DIVARICATORE ADDOMINALE COLLIN .....	190
CUSHING (TAYLOR) PINZA TC .....	87	DERRA PINZA CARDIOVASCOLARE ATRAUMATICA .....	515	DIVARICATORE ADDOMINALE COLLIN-LOKITTLE .....	191
CUSHING DIVARICATORE .....	151	D'ERRICO UNCINO PER NERVI .....	329/2	DIVARICATORE ADDOMINALE COMPLETO KIRSCHNER .....187/1	
CUSHING DIVARICATORE .....	152	DESCHAMPS AGO PER LEGATURE .....	218	DIVARICATORE ADDOMINALE DENIS-BROWNE .....	185
CUSHING DIVARICATORE .....	153	DESJARDINS CUCCHIAIO PER CALCOLI BILIARI .....	534	DIVARICATORE ADDOMINALE FRAZIER .....	181
CUSHING PERFORATORE .....	299	DESJARDINS PINZA EMOSTATICA .....	121	DIVARICATORE ADDOMINALE GELPI .....	189/2
CUSHING PINZA ANATOMICA .....	83	DESJARDINS PINZA PER CALCOLI BILIARI .....	531	DIVARICATORE ADDOMINALE HORGAN .....	183
CUSHING PINZA CHIRURGICA .....	83	DESJARDINS Sonda PER CALCOLI BILIARI .....	532	DIVARICATORE ADDOMINALE JACKSON BURROWS 189/2 .....	
CUSHING PINZA TAGLIENTE PER LAMINECTOMIA .....	340	DESMARRES DIVARICATORE .....	151	DIVARICATORE ADDOMINALE KIRSCHNER .....	185
CUSHING SPATOLA CEREBRALE .....	369	DESMARRES PINZA PER CALAZIO .....	393	DIVARICATORE ADDOMINALE RICARD .....	191
CUSHING UNCINO PER NERVI .....	328	DEUTSCHMANN COLTELLO PER CATARATTA .....	371	DIVARICATORE ADDOMINALE RIGBY .....	189/2
CUZZI CUCCHIAIO PER ABORTO .....	606	DEVILBISS PINZA PER CRANIOTOMIA .....	332	DIVARICATORE ADDOMINALE RICHARD .....	186
CZERNY PINZA PER ABBASSARE IL COLLO DELL'UTERO .....	584	DEVILBISS PINZA PER CRANIOTOMIA .....	332	DIVARICATORE ADDOMINALE, DE BAKEY .....	189/1
CZERNY SPECOLO RETTALE .....	559	DIAPASON .....	404	DIVARICATORE ADDOMINALE, DOYEN .....	189/1
D		DIAPASON, HARTMANN .....	403	DIVARICATORE ADDOMINALE, GELPI .....	189/1
DANDY PINZA EMOSTATICA .....	109	DIAPASON, LUCAE .....	404	DIVARICATORE ADDOMINALE, SET COMPLETO, CON MORSETTI E VALVE .....	193
DANDY UNCINO PER NERVI .....	328	DIAPASON, REDA .....	403	DIVARICATORE ADDOMINALE, SET COMPLETO, CON SISTEMA DI MONTAGGIO .....	192
DARLING DIVARICATORE .....	178	DIAPASONN, RYDEL-SEIFFERT .....	404	DIVARICATORE ADSON .....	172
DARTIGUES PINZA PER AFFERRARE L'UTERO .....	585	DIFFENBACH PINZA VASCOLARE .....	104	DIVARICATORE ADSON .....	174
DASTOOR PINZA PER STRABISMO .....	386	DIETER MIKRO-PINZA AURICOLARE .....	414	DIVARICATORE ANALE, SMITH-BUIE .....	561
DAUBENSPECK CURETTA TAGLIENTE .....	255	DIETRICH PINZA MINI BULLDOG .....	101	DIVARICATORE AUFRANC-COBRA .....	289
DAVIDSON(SCAPULA) DIVARICATORE .....	166	DIETRICH FORBICI VASCOLARI .....	60	DIVARICATORE COLLIN .....	139
DAVIEL CUCCHIAIO PER CATERATTA .....	377	DIETRICH PINZA AORTA .....	510	DIVARICATORE COSTALE, COOLEY .....	487
DAVIS AGO PER CORPI ESTRANEI .....	374	DILATATOR TRACHEALE LABORDE .....	476	DIVARICATORE COSTALE, COOLEY-NEONATAL .....	485
DAVIS DURA DISSETTORE .....	332	DILATATORE COOLEY .....	528	DIVARICATORE COSTALE, DE BOER .....	486
DAVIS PINZA PER STERILIZZAZIONE .....	227	DILATATORE PER CANALE LACRIMALE, WILDER .....	381	DIVARICATORE COSTALE, FINOCHIETTO-BURFORD .....	483
DAVIS SPATOLA CEREBRALE .....	337	DILATATORE PER CANALE LACRIMALE, ZIEGLER .....	381	DIVARICATORE COSTALE, HAIGHT .....	487
DAVIS-BOYLE ABBASSALINGUA .....	455	DILATATORE PER CANALE LACRIMALE, CASTROVIEJO .....	381	DIVARICATORE COSTALE, MORSE .....	484
DAVIS-BOYLE APRIBOCCA .....	455	DILATATORE PER CONDOTTI BILIARI, BAKES .....	532	DIVARICATORE COSTALE, MORSE-FAVALORO .....	484
DAVIS-MEYER APRIBOCCA .....	457	DILATATORE PER SENO FRONTALE RITTER-HALLE .....	433	DIVARICATORE COSTALE, MORSE .....	484
DAY UNCINO .....	409	DILATATORE TRACHEALE, TROUSSEAU-BABY .....	476	DIVARICATORE COSTALE, MORSE-FAVALORO .....	484
DE BAKEY PINZE ATRAUMATICHE BULLDOG .....	103	DILATATORE TRACHEALE, TROUSSEAU .....	476	DIVARICATORE COSTALE, RIENHOFF-FINOCHIETTO .....	486
DE BAKEY PINZE ATRAUMATICHE IN TITANIO .....	99	DILATATORE TUBBS .....	528	DIVARICATORE COSTALE, TUFFIER .....	487
DE BAKEY CANNULA D'ASPIRAZIONE .....	28	DILATATORE UTERINO GOODELL .....	581	DIVARICATORE CUSHING .....	152
DE BAKEY DILATATORE VASCOLARE .....	529	DILATATORE UTERINO HANK .....	580	DIVARICATORE CUSHING .....	153
DE BAKEY DIVARICATORE ADDOMINALE .....	189/1	DILATATORE UTERINO HEGAR .....	578, 579	DIVARICATORE DELEE .....	574

DIVARICATORE FINSEN .....	168	DIVARICATORE, COOLEY .....	148	DOYEN PINZA INTESTINALE .....	540
DIVARICATORE HARRINGTON-PEMBERTON .....	147	DIVARICATORE, CORYLLOS .....	166	DOYEN PINZA PER POLIPI UTERINI .....	585
DIVARICATORE KIRSCHNER .....	187	DIVARICATORE, CRILE .....	140	DOYEN SPECILLO SCANALATO .....	199
DIVARICATORE KOCHER .....	155	DIVARICATORE, CUSHING .....	151	DOYEN SPECOLO VAGINALE .....	574
DIVARICATORE KOCHER .....	159	DIVARICATORE, DARLING .....	178	DOYEN TIRAMIOMI .....	594
DIVARICATORE KOCHER .....	160	DIVARICATORE, DAVIDSON (SCAPULA) .....	166	DOYEN-BABY PINZA INTESTINALE .....	540
DIVARICATORE KOCHER .....	163	DIVARICATORE, DEAYER .....	145	DOYEN-JANSEN(MOLT) APRIBOCCA .....	454
DIVARICATORE KÖNIG .....	153	DIVARICATORE, DEAYER GRIP .....	146	DOYEN-JANSEN(MOLT) APRIBOCCA .....	454
DIVARICATORE LANGENBECK .....	158	DIVARICATORE, DESMARRRES .....	151	DOYEN-STILLE .....	167
DIVARICATORE LANGENBECK .....	159	DIVARICATORE, DINGMANN .....	463	DUBOIS FORBICI GINECOLOGICHE .....	63
DIVARICATORE MARTIN .....	175/1	DIVARICATORE, DOYEN .....	163	DUPLAY PINZA PER ABBASSARE IL COLLO	
DIVARICATORE MAYO-ADAMS .....	171	DIVARICATORE, DOYEN-STILLE .....	167	DELL'UTERO .....	582
DIVARICATORE MEYERDING .....	157	DIVARICATORE, FARABEUF .....	139	DUPLAY PINZA PER MEDICATURA .....	134
DIVARICATORE MEYERDING .....	177	DIVARICATORE, FRITSCH .....	163	DUPLEX STETOSCOPIO .....	23
DIVARICATORE MURPHY .....	156	DIVARICATORE, GIL-VERNET .....	152	DUPUY-WEISS AGO PER TONSILLE .....	466
DIVARICATORE NORFOLK-NORDWICH .....	172	DIVARICATORE, GOELET .....	141	DURA DISSETTORE .....	332
DIVARICATORE OBWEGESER .....	460, 461	DIVARICATORE, GREEN .....	160	DURA DISSETTORE, DAVIS .....	332
DIVARICATORE PELVICO, ST.MARKS .....	165	DIVARICATORE, HARRINGTON .....	147	DURA DISSETTORE, FRAZIER .....	333
DIVARICATORE PER CHIRURGIA PLASTICA BREAST .....	198	DIVARICATORE, HEANEY .....	164	DURA DISSETTORE, HOEN .....	333
DIVARICATORE PER CHIRURGIA PLASTICA CORONAL		DIVARICATORE, HENLEY .....	170	DURA DISSETTORE, HORSLEY .....	333
BLOW .....	198	DIVARICATORE, HIBBS .....	164	DURA DISSETTORE, MILLIGAN .....	332
DIVARICATORE PER CHIRURGIA PLASTICA FERRIERA .....	197	DIVARICATORE, HOESEL .....	167	DURA DISSETTORE, OLIVECRONA .....	332
DIVARICATORE PER CHIRURGIA PLASTICA FREEMAN .....	198	DIVARICATORE, HOFER .....	465	DURA DISSETTORE, SACHS .....	332
DIVARICATORE PER CHIRURGIA PLASTICA TEBBETS .....	197	DIVARICATORE, HOLZHEIMER .....	168	DURA DISSETTORE, TOENNIS .....	332
DIVARICATORE PER CHIRURGIA PLASTICA		DIVARICATORE, ISRAEL .....	162	DURA DISSETTORE, WOODSON .....	333
YANCOSKIE .....	198	DIVARICATORE, JANSEN .....	168	DURANTE PINZA DA PRESA .....	88
DIVARICATORE PER CORPI VERTREBRALI, CLOWARD .....	339	DIVARICATORE, KELLY .....	164	DUVAL PINZA DA PRESA .....	85
DIVARICATORE PER CORPI VERTREBRALI, INGE .....	339	DIVARICATORE, KELLY GRIP .....	142	DUVAL PINZA PER AFFERRARE INTESTINI .....	539
DIVARICATORE PER GESSI REDA .....	232	DIVARICATORE, KOCHER-LANGENBECK .....	159		
DIVARICATORE PER GESSI, BEESON .....	232	DIVARICATORE, KOERTE .....	162		
DIVARICATORE PER GESSI, HAGLUND-STILLE .....	232	DIVARICATORE, LAHEY .....	157		
DIVARICATORE PER GESSI, HENNING .....	232	DIVARICATORE, LITTLE .....	157		
DIVARICATORE PER GUANCE, STERNBERG .....	453	DIVARICATORE, LOVE .....	465		
DIVARICATORE PER LA PROSTATA, YOUNG .....	550	DIVARICATORE, MATHIEU .....	141		
DIVARICATORE PER LABBRA .....	453	DIVARICATORE, MEYERDING .....	180		
DIVARICATORE PER LAMINECTOMIA SCOVILLE .....	196	DIVARICATORE, MIDDELDORPF .....	160		
DIVARICATORE PER LAMINECTOMIA		DIVARICATORE, MIKULICZ .....	163		
SCOVILLE-HAVERFIELD .....	196	DIVARICATORE, MOLLISON .....	171		
DIVARICATORE PER LAMINECTOMIA, CHERRY .....	488	DIVARICATORE, MORRIS .....	164		
DIVARICATORE PER SPINA CERVICALE CASPAR .....	179	DIVARICATORE, NAGER .....	465		
DIVARICATORE PER SPINA CERVICALE CASPAR .....	180	DIVARICATORE, OLLIER .....	162		
DIVARICATORE PER TIROIDE, SCHOENBORN .....	479	DIVARICATORE, PARKER .....	139		
DIVARICATORE PER TORACE, MERCEDES .....	489	DIVARICATORE, PLESTER .....	171		
DIVARICATORE PERKINS .....	168	DIVARICATORE, RAGNELL .....	140		
DIVARICATORE ROSE .....	140	DIVARICATORE, RAMUS .....	461		
DIVARICATORE SAUERBRUCH .....	164	DIVARICATORE, RICHARDSON .....	142		
DIVARICATORE SAUERBRUCH .....	166	DIVARICATORE, RICHARDSON GRIP .....	142		
DIVARICATORE SCALP-CONTOUR .....	169	DIVARICATORE, RICHARDSON-EASTMAN .....	142		
DIVARICATORE SPINALE, TAYLOR .....	291	DIVARICATORE, ROUX .....	139		
DIVARICATORE STRANDELL-STILLE .....	157	DIVARICATORE, ROUX-BABY .....	140		
DIVARICATORE TESSIER .....	463/3	DIVARICATORE, ROUX-MINI .....	140		
DIVARICATORE TRACHEALE .....	476	DIVARICATORE, SENN-GREEN .....	153		
DIVARICATORE TRACHEALE, ITERSON .....	477	DIVARICATORE, SENN-MILLER .....	143		
DIVARICATORE TRACHEALE, JACKSON .....	476	DIVARICATORE, SIMON .....	164		
DIVARICATORE TRACHEALE, NEWS .....	477	DIVARICATORE, SPINA-NASALIS .....	461		
DIVARICATORE TRAVERS .....	172	DIVARICATORE, VOLKMANN .....	153		
DIVARICATORE TUFFIER .....	147	DIVARICATORE, VOLKMANN .....	154		
DIVARICATORE VESCICALE, LEGUE .....	553	DIVARICATORE, WEITLANER .....	169		
DIVARICATORE VESCICALE, MILLIN .....	552	DIVARICATORE, WEITLANER-WULLSTEIN .....	169		
DIVARICATORE VESCICALE, MILLIN .....	553	DIVARICATORE, ZENKER .....	161		
DIVARICATORE VESCICALE, THOMSON-WALKER .....	552	DIVARICATORE, US-ARMY PARKER-LANG .....	141		
DIVARICATORE VESCICALE, JUDD-MASSON .....	552	DIVISORE PER CRANIO .....	267		
DIVARICATORE VOLKMANN .....	156	DIX SGORBIA PER CORPI ESTRANEI .....	374		
DIVARICATORE WULLSTEIN .....	171	DIX STRUMENTI PER CORPI ESTRANEI .....	380		
DIVARICATORE, ADSON .....	173	DOUGHTY ABBASSALINGUA .....	458		
DIVARICATORE, ALM .....	168	DOUGLAS COLTELLO PER TONSILLE .....	466		
DIVARICATORE, ANDERSON-ADSON .....	172	DOUGLAS PINZA DEPILATORIA .....	395		
DIVARICATORE, BECKMANN .....	176	DOYEN DIVARICATORE .....	163		
DIVARICATORE, BECKMANN-ADSON .....	175	DOYEN DIVARICATORE ADDOMINALE .....	189/1		
DIVARICATORE, BECKMANN-EATON .....	176	DOYEN FORBICI GINECOLOGICHE .....	63		
DIVARICATORE, BRUNNER .....	167	DOYEN PERIOSTOTOMO .....	278		
DIVARICATORE, CLOWARD .....	178	DOYEN PERIOSTOTOMO .....	278		
DIVARICATORE, COLLIN HARTMANN .....	141	DOYEN PINZA FISSATELI .....	133		

ELEVATORE QUERVAIN.....	275	FISCH UNCINO.....	335	FORBICI PER DISSEZIONE, LEXER.....	53
ELEVATORE SEBILAU.....	275	FISCH DISSETTORE.....	420	FORBICI PER DISSEZIONE, LEXER-BABY.....	53
ELEVATORE, ALDERDYCE.....	282	FISCHER PINZA PER IRIDE.....	384	FORBICI PER DISSEZIONE, LEXER-BABY TC.....	53
ELEVATORE, BOIES.....	277	FISH SPECILLO.....	199	FORBICI PER DISSEZIONE, MAYO-NOBLE.....	52
ELEVATORE, CREGO.....	282	FISHER COLTELLO PER TONSILLE.....	466	FORBICI PER DISSEZIONE, METZENBAUM.....	53/1
ELEVATORE, FREER.....	434	FOERSTER PINZA PER IRIDE.....	383	FORBICI PER DISSEZIONE, METZENBAUM FINO.....	53/1
ELEVATORE, KEY.....	282	FOERSTER PINZA PER MEDICATURA.....	136	FORBICI PER DISSEZIONE, METZENBAUM TC.....	53/1
ELEVATORE, LEMPERT.....	420	FOMON FORBICI NASALI.....	58	FORBICI PER DISSEZIONE, TOENNIS-ADSON.....	65
ELEVATORE, MCDONALD, 19CM.....	283	FOMON FORBICI PER RINOPLASTICA.....	65/1	FORBICI PER DISSEZIONE, WELLER.....	53/2
ELEVATORE, MURPHY-LANE.....	283	FOMON PERIOSTOTOMO.....	277	FORBICI PER DISSEZIONE, METZENBAUM FINO TC.....	53/1
ELEVATORE, SAYRE.....	281	FOMON RASPA NASALE.....	444	FORBICI PER DURAMADRE, SCHMIEDEN-TAYLOR.....	65/1
ELEVATORE, WATSON-CHEYNE.....	283	FOMON SCALPELLO PER SETTO.....	441	FORBICI PER ENTEROTOMIA.....	66
ELLIOT FORCIPE.....	602	FOMON TC RASPA NASALE.....	445	FORBICI PER EPISIOTOMIA, BRAUN-STADLER.....	64
ELLIS SGORBIA PER CORPI ESTRANEI.....	374	FOMON UNCINO PER LA PELLE.....	447/1	FORBICI PER EPISIOTOMIA, WALDMANN.....	64
ELSCHING DISSETTORE CORNEALE.....	373	FORBICE PER IL SETTO NASALE, KILLIAN.....	471	FORBICI PER FILO DI METALLO E LAMIERA, UNIVERSAL.....	67
ELSCHING SPATOLA PER CICLIDIALISI.....	379	FORBICE PER LE UNGHIE.....	609	FORBICI PER INCISIONE.....	52
ELSCHNIG PINZA CAPSULARE.....	391	FORBICE PER PELLE.....	610	FORBICI PER ISTERECTOMIA, WERTHEIM.....	63
ELSCHNIG PINZA FISSATRICE.....	389	FORBICI BULLDOG COTTLE.....	56	FORBICI PER LEGATURE, HEATH.....	66
EMMETT UNCINO PER FISTOLE.....	594	FORBICI CORNEALI, CASTROVIEJO.....	79	FORBICI PER LEGATURE, LITTAUER.....	66
ENDOSPECOLO KOGAN.....	577	FORBICI GINECOLOGICHE, DOYEN.....	63	FORBICI PER LEGATURE, NORTHBENT.....	66
ENGEL SEGA PER GESSI.....	229	FORBICI GINECOLOGICHE, DUBOIS.....	63	FORBICI PER LEGATURE, SPENCER.....	66
ENUCLATORE PER TENDINI, BRAND.....	294	FORBICI GINECOLOGICHE, SIEBOLD.....	62	FORBICI PER NEUROCHIRURGIA.....	65
ENUCLATORE PER TENDINI, BUNELL.....	292	FORBICI GINECOLOGICHE, SIMS.....	62	FORBICI PER NEUROCHIRURGIA, STRULLY.....	65
EPKER OSTEOTOMI.....	464/2	FORBICI GINGIVALI, GOLDMAN-FOX.....	67	FORBICI PER OFTALMOLOGIA.....	57
EPPENDORFFER PINZA PER BIOPSIA.....	590	FORBICI GINGIVALI, LA GRANGE.....	69	FORBICI PER OFTALMOLOGIA GRADLE.....	57
ERRICO PERFORATORE.....	299	FORBICI GINGIVALI, LOCKLIN.....	69	FORBICI PER OFTALMOLOGIA, AEBLI.....	58
ESMARCH BENDA PER COMPRESSIONE.....	297	FORBICI GINGIVALI, QUINBY.....	67	FORBICI PER OFTALMOLOGIA, STEVENS.....	58
ESMARCH COLTELLO PER GESSI.....	233	FORBICI GRAEFE.....	56	FORBICI PER PARAMETRIO.....	63
ESMARCH FORBICI PER BENDAGGI.....	69/2	FORBICI NASALI.....	429	FORBICI PER RINOPLASTICA FOMON.....	65/1
ESTENSIONE DELL'ARTICOLAZIONE.....	188	FORBICI NASALI, COTTLE.....	59	FORBICI PER STERNO SCHUMACHER.....	481
ESTRATTATORE, KUENTSCHER.....	322	FORBICI NASALI, FOMON.....	58	FORBICI PER STRABISMO.....	58
ETHICON PINZA APPLICATORE CLIPS.....	524, 525	FORBICI NASALI, HEYMANN.....	58	FORBICI PER STRABISMO.....	58
EVES SERRANODI PER TONSILLE.....	468	FORBICI OCULISTICHE WESTCOTT.....	75	FORBICI PER TONSILLE.....	59
EXACTA SFIGMOMANOMETRO.....	8	FORBICI OCULISTICHE, BARRAQUER.....	75	FORBICI PER TONSILLE, BOETTCHER.....	59
		FORBICI OCULISTICHE, NOYES.....	75	FORBICI PER TONSILLE, DEAN.....	59
F		FORBICI OCULISTICHE, VANNAS.....	79	FORBICI PER TONSILLE, GOOD.....	59
FACE LIFT FORBICI FREEMAN.....	74	FORBICI OCULISTICHE, WECKER.....	75	FORBICI PER TONSILLE, PRINCE.....	59
FACE LIFT FORBICI GORNEY.....	73	FORBICI PER BENDAGGI.....	70	FORBICI POLMONARE, CRAFTOORD.....	65/2
FACE LIFT FORBICI KAYE.....	73	FORBICI PER BENDAGGI, BERGMANN.....	69/1	FORBICI TORACALI, THOREK.....	65/2
FACE LIFT FORBICI REES.....	73	FORBICI PER BENDAGGI, BRUNS.....	70	FORBICI VASCOLARI DEBAKEY TC.....	60
FANSLER PROCTOSCOPO.....	565	FORBICI PER BENDAGGI, ESMARCH.....	69/2	FORBICI VASCOLARI, DE BAKEY.....	61
FARABEUF DIVARICATORE.....	139	FORBICI PER BENDAGGI, KNOWLES.....	70	FORBICI VASCOLARI, DIETRICH.....	60
FARABEUF PERIOSTOTOMO.....	274	FORBICI PER BENDAGGI, LISTER.....	69/1	FORBICI VASCOLARI, FAVALORO.....	61
FARABEUF TENAGLIA PER OSSA.....	243	FORBICI PER BENDAGGI, LORENZ.....	70	FORBICI VASCOLARI, KELLY.....	61
FARABEUF-COLLIN PERIOSTOTOMO.....	274	FORBICI PER BENDAGGI, REDA EXCENTER.....	69/2	FORBICI VASCOLARI, KLINKENBERG-LOTH.....	65/2
FARABEUF-LAMBOTTE TENAGLIA PER OSSA.....	243	FORBICI PER BENDAGGI, SEUTIN.....	69/2	FORBICI VASCOLARI, POTTS-DE MARTEL.....	59
FARRELL PORTACOTONE.....	203	FORBICI PER BENDAGGI, SMITH US ARMY.....	69/1	FORBICI VASCOLARI, POTTS-SMITH.....	61
FAULKNER CURETTA.....	449	FORBICI PER BENDAGGI, UNIVERSAL.....	70	FORBICI VASCOLARI, SATINSKY.....	65/2
FAURE PINZA PER BIOPSIA.....	588	FORBICI PER CAPSULA, RESANO.....	53/2	FORBICI WAGNER.....	67
FAURE PINZA PERITONEALE.....	123	FORBICI PER CARTILAGINE, MARTIN.....	65/1	FORCIPE, BARTON.....	603
FAVALORO FORBICI VASCOLARI.....	61	FORBICI PER CARTILAGINE, MCINDOE.....	65/1	FORCIPE, BOERMA.....	604
FEHLAND PINZA INTESTINALE.....	542	FORBICI PER CHIRURGIA FINE, IRIS.....	54	FORCIPE, DE LEE.....	602
FEILCHENFELD PINZA PER SCHEGGE.....	91	FORBICI PER CHIRURGIA FINE, JOSEPH.....	54	FORCIPE, ELLIOT.....	602
FELDHEIM PINZA PER OSSA.....	249	FORBICI PER CHIRURGIA FINE, KILNER.....	54	FORCIPE, KIELLAND.....	602
FERGUSON CUCCHIAIO PER CALCOLI BILIARI.....	533	FORBICI PER CHIRURGIA FINE, REYNOLDS.....	54	FORCIPE, KIELLAND-LUIKART.....	603
FERGUSON FORBICI PER CHIRURGIA.....	66	FORBICI PER CHIRURGIA FINE, SANVENERO.....	54	FORCIPE, LUIKART.....	603
FERGUSON FRAZIER CANNULA D'ASPIRAZIONE.....	337	FORBICI PER CHIRURGIA STANDARD.....	51	FORCIPE, MCLEAN.....	603
FERGUSON PINZA EMORROIDALE.....	109	FORBICI PER CHIRURGIA, FERGUSSON.....	66	FORCIPE, MCLEAN-LUIKART.....	603
FERGUSON TENAGLIA PER OSSA.....	243	FORBICI PER CHIRURGIA, METZENBAUM.....	54	FORCIPE, MCLEAN-TUCKER.....	603
FERRIERA DIVARICATORE PER CHIRURGIA PLASTICA.....	197	FORBICI PER CHIRURGIA, SYSTRUNK.....	66	FORCIPE, MCLEAN-TUCKER-LUIKART.....	603
FERRIS-SMITH PINZA CHIRURGICA.....	84	FORBICI PER CORDA OMBELICALE, BUSCH.....	64	FORCIPE, NAEGELE.....	602
FERRIS-SMITH PINZA TAGLIANTE PER LAMINECTOMIA.....	343	FORBICI PER CORDA OMBELICALE, MOD.USA.....	64	FORCIPE, PIPER.....	604
FERRIS-SMITH-KERRISON PINZA TAGLIANTE PER DISCHI INTERVERTEBRALI.....	344, 344/2	FORBICI PER CORDA OMBELICALE, SCHUMACHER.....	64	FORCIPE, SIMPSON.....	602
FICHOCHIETTO-BABY DIVARICATORE COSTALE.....	482	FORBICI PER CORONA, BEEBEE.....	68	FORCIPE, SIMPSON-BRAUN.....	602
FILO PER OSSA.....	314	FORBICI PER DISSEZIONE.....	52	FORCIPE, SIMPSON-LUIKART.....	603
FINOCCHIETTO DIVARICATORE COSTALE.....	482, 484	FORBICI PER DISSEZIONE DEAYER.....	52	FORCIPE, WRIGLEY.....	602
FINOCCHIETTO PINZA PER BRONCHI.....	490	FORBICI PER DISSEZIONE MAYO.....	52	FOREGGER LARINGSOCOPIO.....	29
FINOCCHIETTO DIVARICATORE COSTALE.....	484	FORBICI PER DISSEZIONE MAYO, TC.....	52	FOREGGER LARINGSOCOPIO SET.....	31
FINOCCHIETTO PORT'AGHI.....	211	FORBICI PER DISSEZIONE MAYO-STILLE.....	52	FOX CURETTA PER LUPUS.....	608
FINOCCHIETTO-BURFORD DIVARICATORE COSTALE.....	483	FORBICI PER DISSEZIONE MAYO-STILLE, TC.....	52	FRAENKEL INSERTO.....	472
FINSEN DIVARICATORE.....	168	FORBICI PER DISSEZIONE METZENBAUM.....	53/1	FRAENKEL PINZA PER POLIPI LARINGEI.....	471
		FORBICI PER DISSEZIONE, JORGENSEN.....	53	FRANCIS AGO PER CORPI ESTRANEI.....	374

FRANKLIN-SILVERMANN AGO PER BIOPSIA .....	206	GRAFFA PER IL CUIOIO CAPELLUTO, RANEY .....	327	HEIFETZ SPATOLA CEREBRALE .....	369
FRAZIER DIVARICATORE ADDOMINALE .....	181	GRAHAM UNCINO PER NERVI .....	329	HEIMING PINZA PER CALCOLI RENALI .....	536
FRAZIER DURA DISSETTORE .....	333	GRAIG PINZA NASALE .....	426	HEISS PINZA EMOSTATICA .....	112
FRAZIER UNCINO PER LA PELLE .....	149	GRAVE SPECOLO VAGINALE .....	570	HEISTER APRIBOCCA .....	454
FREEMAN DIVARICATORE PER CHIRURGIA PLASTICA .....	198	GRAY PINZA EMOSTATICA .....	121	HENKE ELEVATORE PER TONSILLE .....	465
FREEMAN FACE LIFT FORBICI .....	74	GREEN DISSETTORE CORNEALE .....	374	HENLEY DIVARICATORE .....	170
FREER COLTELLO PER SETTO NASALE .....	434	GREEN DIVARICATORE .....	160	HENNIG DIVARICATORE PER GESSI .....	232
FREER ELEVATORE .....	434	GREEN PINZA FISSATRICE .....	390	HEPP-SCHEIDEL MICRO FORBICI .....	78
FREER ELEVATORE PER SETTO .....	437	GREEN UNCINO PER IL STRABISMO .....	375	HERRICK PINZA PER PUNCOLO RENALE .....	123
FREER SCALPELLO PER SETTO .....	.....	GREEN-ARMYTAGE PINZA UTERINA PER EMOSTASI .....	605	HESS PINZA CAPSULARE .....	391
FREER UNCINO PER LA PELLE .....	448	GREGORY PINZA CARDIOVASCOLARE ATRAUMATICA .....	517	HESS PINZA PER IRIDE .....	384
FRENZEL ABBASSALINGUA .....	451	GREVEN MIKRO-PINZA AURICOLARE .....	414	HESS UNCION PER NERVI .....	329/1
FRENZEL OCCHIALI NISTAGMO .....	20	GROSS CUCCHIAIO AURICOLARE .....	409	HEYMANN PINZA PER SETTO NASALE .....	425
FRIEDMANN MINI PINZA SGORBIA .....	234	GROSS-MAIER PINZA PER MEDICATURA .....	134	HEYMANN FORBICI NASALI .....	58
FRIEDMANN SPECOLO VAGINALE .....	577	GRUBER SPECOLO AURICOLARE .....	399	HEYMANN-KNIGHT PINZA AURICOLARE .....	425
FRI TSCH DIVARICATORE .....	163	GUAINA PER VITI .....	325	HEYWOOD-SMITH PINZA PER EMORROIDI .....	567
FRYKHOLM PINZA SGORBIA .....	240	GUIDA CONDUTTRICE .....	321	HIBBS OSTEOTOMO .....	265
FUCHS PINZA CAPSULARE .....	391	GUIDA TENDINI, BUNELL .....	294	HIBBS DIVARICATORE .....	164
FUCHSIG PINZA EMOSTATICA .....	113	GULEN CANNULA PER ASPIRAZIONE .....	433/1	HIBBS SCALPELLO .....	265
G		GUTHRIE UNCINO PER LA PELLE .....	149	HIBBS SGORBIA .....	265
GALLAHER RASPA NASALE .....	446	GUYON CANDELETTA DILATRICE .....	554	HILL-FERGUSON SPECOLO RETTALE .....	560
GASS UNCINO .....	376	GUYON INTRODUTTORE PER CATETERI .....	554	HIRSCHMAN SPATOLA PER CICLODIALISI .....	379
GAUSS PINZA PER IL CUIOIO CAPELLUTO .....	605	GUYON PINZA EMOSTATICA .....	122	HIRSCHMANN ANOSCOPO .....	562
GELPI DIVARICATORE ADDOMINALE .....	189/1	GUYON PINZA RENALE .....	122	HOEN DURA DISSETTORE .....	333
GELPI DIVARICATORE ADDOMINALE .....	189/2	GUYTON-LUNDSGAARD SCLEROTOMO .....	373	HOESEL PORT'AGHI .....	213
GEMINI PINZA EMOSTATICA .....	115	H		HOESEL PORT'AGHI .....	213
GERALD PINZA ANATOMICA .....	86	HABERER SPATOLA ADDOMINALE E INTESTINALE .....	143/1	HOFER DIVARICATORE .....	465
GERALD PINZA CHIRURGICA .....	87	HAGLUND-STILLE DIVARICATORE PER GESSI .....	232	HOFFMANN PINZA SERRATUBI .....	624
GERSTER PINZA PER OSSA .....	250	HAIGHT DIVARICATORE COSTALE .....	487	HOHMANN MINI ELEVATORE PER OSSA .....	286
GERZOG MARTELLO .....	270	HAJEK MARTELLO .....	273	HOLINGER LARINGOSCOPIO PER OPERAZIONE .....	37
GHIGLIOTTINA PER TAGLIARE FILI 32CM .....	320	HAJEK SCALPELLO PER SETTO .....	442/1	HOLLINGER PORTATORE DI LUCE .....	37
GIERTZ-STILLE COSTOTOMO .....	481	HAJEK-BALLENGER ELEVATORE PER SETTO .....	439	HOLSHER UNCINO PER RADICI DEI NERVI .....	329/1
GIGLI SEGA .....	332	HAJEK-KOFLER PINZA SFENOIDALE .....	430, 431	HOLTH PINZA TAGLIANTE PER CAPSULA .....	380
GILL DISSETTORE CORNEALE .....	373	HALLE CURETTA TAGLIANTE .....	253	HOLZBACH PINZA PER ISTERECTOMIA .....	126
GILL PINZA PER IRIDE .....	384	HALLE ELEVATORE PER SETTO .....	437	HOLZBACH PINZA PER ISTERECTOMIA .....	126
GILL-ARRUGA PINZA CAPSULARE .....	390	HALSEY PORT'AGHI .....	208	HOLZHEIMER DIVARICATORE .....	168
GILL-HESS PINZA PER IRIDE .....	384	HALSTED-MOSQUITO PINZA EMOSTATICA .....	105	HOPKINS COLTELLO PER GESSI .....	233
GILLIES PINZA CHIRURGICA .....	86	HANK DILATATORE UTERINO .....	580	HORGAN DIVARICATORE ADDOMINALE .....	183
GILLIES PORT'AGHI .....	212	HARGIS ELEVATORE PER PERIOSTIO .....	463/2	HORIZON PINZA APPLICATORE CLIPS .....	524, 525
GILLIES UNCINO PER LA PELLE .....	448	HARGIS SEPERATORE PER IL CORPO		HORSLEY DURA DISSETTORE .....	333
GIL-VERNET DIVARICATORE .....	152	MANDIBOLARE .....	463/6	HÖSEL DIVARICATORE .....	167
GIUNTO DI PROLUNGAMENTO .....	299	HARKEN PINZA AURICOLA .....	503	HOUSE CANNULA D'ASPIRAZIONE .....	337/2
GLOVER BULLDOG PINZA ATRAUMATICA .....	100	HARMS, SONDA .....	381	HOUSE CURETTA .....	420
GLOVER BULLDOG PINZA ATRAUMATICA .....	103	HARRINGTON DIVARICATORE .....	147	HOWARTH ELEVATORE PER SETTO .....	438
GLOVER PINZA VASCOLARE .....	515	HARRINGTON PINZA PER BRONCHI .....	490	HUBER MANICO UNIVERSALE .....	472
GLUCK COSTOTOMO .....	480	HARRINGTON-PEMBERTON DIVARICATORE .....	147	HUDSON MANICO A T .....	300
GOELT DIVARICATORE .....	141	HARTMANN ABBASSALINGUA .....	452	HUDSON PERFORATORE A MANO .....	299
GOLDMANN-FOX FORBICI GINGIVALI .....	67	HARTMANN CANNULA PER IRRIGAZIONE .....	433	HULKA PINZA PER ABBASSARE IL COLLO	
GOMEL MICRO FORBICI .....	80	HARTMANN CATETERE AURICOLARE .....	408	DELL'UTERO .....	583
GOMEL MICROPINZA CHIRURGICA .....	96	HARTMANN DIAPASON .....	403	HUMBY DERMATOMO .....	50
GONIOMETRO PER LE DITA .....	25	HARTMANN PINZA PER CORPI ESTRANEI .....	412	HUNTER PINZA PER SCHEGGE .....	91
GONIOMETRO, MOELTGEN .....	25	HARTMANN PINZA EMOSTATICA .....	104	HURD DISSETTORE PER TONSILLE .....	465
GOOD FORBICI PER TONSILLE .....	59	HARTMANN PINZA PER POLIPI .....	424	I	
GOODELL DILATATORE UTERINO .....	581	HARTMANN SPECOLO AURICOLARE .....	399	I.U.D. PINZA DA PRESA FLESSIBILE, SERPENTINE .....	593
GORNEY DISSETTORE .....	277	HARTMANN SPECOLO NASALE .....	422	I.U.D. UNCINO ESTRATTORE .....	593
GORNEY FACE LIFT FORBICI .....	73	HARTMANN-HALLE SPECOLO NASALE .....	421	IMPATTATORE .....	322
GOSSET DIVARICATORE ADDOMINALE .....	181	HARTMANN-HOFFMANN PINZA PER CORPI		IMPATTATORE / ESTRATTORE .....	322
GOURDET CUCCHIAIO UTERINO .....	599	ESTRANEI .....	412	IMPATTATORE FINALE, KUENTSCHER .....	321
GRADLE FORBICI PER OFTALMOLOGIA .....	57	HARTMANN-WULLSTEIN PINZA PER CORPI		INGE DIVARICATORE PER CORPI VERTTEBRALI .....	339
GRADLE PINZA DEPILTORIA .....	395	ESTRANEI .....	412	INSERTO, BARACANI .....	472
GRAEFTE BLEFAROSTATO .....	370	HAUGH MIKRO-PINZA AURICOLARE .....	414	INSERTO, BRUENINGS .....	472
GRAEFTE CISTOTOMO .....	375	HAYES PINZA PER ANASTOMOSI DEL RETTO .....	545	INSERTO, CORDES .....	472
GRAEFTE COLTELLO LANCEOLARE .....	372	HEANEY PINZA PER ISTERECTOMIA .....	126	INSERTO, FRAENKEL .....	472
GRAEFTE COLTELLO LANCEOLARE .....	372	HEANEY PORT'AGHI .....	210	INSERTO, FRAENKEL .....	472
GRAEFTE COLTELLO PER CATARATTA .....	371	HEANY CURETTA PER BIOPSIA .....	587	INSERTO, KRAUSE .....	472
GRAEFTE CUCCHIAIO PER CATERATTA .....	377	HEANY DIVARICATORE .....	164	INSERTO, LANGE .....	472
GRAEFTE FORBICI .....	56	HEANY-BALLETINE PINZA PER ISTERECTOMIA .....	127	INSERTO, SCHEINMANN .....	472
GRAEFTE PINZA DA PRESA .....	83	HEATH FORBICI PER LEGATURE .....	66	INSERTO, SCHUMACHER .....	472
GRAEFTE PINZA FISSATRICE .....	389	HEATH MARTELLO .....	273	INSERTO, SEIFERT .....	472
GRAEFTE PINZA PER IRIDE .....	382	HEBRA CURETTA DA CALAZIO .....	377	INSOFFIATORE D'ARIA, POLITZER .....	406
GRAEFTE UNCINO .....	149	HEGAR DILATATORE UTERINO .....	578, 579	INSOFFIATORE PER POLVERE, KABIERSKE .....	405
GRAEFTE UNCINO PER IL STRABISMO .....	375	HEGENBARTH PINZA PER AGRAFES .....	224	INSTRU-CARE OLIO PER STRUMENTI .....	634

INTRODUTTORE PER CATETERI GUYON .....554  
 IOWA AGO DI GUIDA.....206  
 IOWA PINZA PER ABBASSARE IL COLLO DELL'UTERO .....584  
 IRIS FORBICI .....54  
 IRIS FORBICI, KNAPP.....55  
 IRIS FORBICI, LITTLER.....55  
 IRIS SUPERCUT FORBICI .....72  
 ISRAEL DIVARICATORE.....162  
 ISTEROMETRO VALLEIX .....586  
 ISTEROMETRO, COLLIN .....586  
 ISTEROMETRO, MARTIN.....586  
 ISTEROMETRO, SIMS.....586  
 ITERSON DIVARICATORE TRACHEALE.....477  
 IVES-FANSLER ANOSCOPO .....562, 563  
 IWANSON COMPASSO.....624

**J**  
 JACKSON BURROWS DIVARICATORE ADDOMINALE...189/2  
 JACKSON DIVARICATORE TRACHEALE.....476  
 JACKSON LARINGOSCOPIO PER OPERAZIONE .....37  
 JACKSON PINZA PER AFFERRARE TENDINI DA PRESA...292  
 JACKSON PINZA PER POLIPI LARINGEI.....471  
 JACKSON SPECOLO VAGINALE.....573  
 JACOBS PINZA PER ABBASSARE IL COLLO  
 DELL'UTERO .....583  
 JACOBSON CURETTA TAGLIENTE.....257  
 JACOBSON PINZA EMOSTATICA .....105  
 JACOBSON PORT'AGHI.....215  
 JACOBSON SONDA BOTTUNUTA.....335  
 JACOBSON UNCINO PER DURA MADRE.....335  
 JAEGER COLTELLO LANCEOLARE.....372  
 JAEGER PLACCA PER PALPEBRE.....371  
 JAMESON PINZA PER STRABISMO.....385  
 JAMESON UNCINO PER IL STRABISMO.....375  
 JANSEN CURETTA TAGLIENTE.....257  
 JANSEN DIVARICATORE.....168  
 JANSEN PINZA AURICOLARE.....424  
 JANSEN PINZA SGORBIA.....237  
 JARCHO PINZA PER ABBASSARE IL COLLO  
 DELL'UTERO .....583  
 JAVID PINZA PER CAROTIDE.....511  
 JENNINGS APRIBOCCA.....454  
 JENSEN CANNULA OCULISTICA.....394  
 JOBSON-HORNE PORTACOTONE.....203  
 JOHNS-HOPKINS BULLDOG PINZA.....104  
 JOHNS-HOPKINS PINZA APPLICATRICE.....104  
 JOHNS-HOPKINS PINZA EMOSTATICA.....120  
 JOHNSON PORT'AGHI.....211  
 JONES PINZA FISSATELI.....132  
 JORGENSEN FORBICI PER DISSEZIONE.....53  
 JOSEPH (LEWIS) RASPA NASALE.....443  
 JOSEPH COLTELLO NASALE.....434  
 JOSEPH ELEVATORE PER SETTO.....437  
 JOSEPH FORBICI PER CHIRURGIA.....54  
 JOSEPH PERIOTOTOMO.....277  
 JOSEPH RASPA NASALE.....443  
 JOSEPH SEGA NASALE.....446  
 JOSEPH UNCINO PER LA PELLE.....149  
 JUDD-ALLIS PINZA PER AFFERRARE INTESTINI.....538  
 JUDD-MASSON DIVARICATORE VESCICALE.....552  
 JUERS MIKRO-PINZA AURICOLARE.....414  
 JURASZ PINZA PER POLIPI LARINGEI.....471

**K**  
 KABIERSKE INSOFFIATORE PER POLVERE.....405  
 KADER SPATOLA ADDOMINALE ED INTESTINALE ....143/1  
 KALLMORGEN SPECOLO VAGINALE.....573  
 KALT PINZA CAPSULARE.....391  
 KALT, PORT'AGHI,.....214  
 KALT-ARRUGA PORT'AGHI.....214  
 KANE PINZA OMBELICALE.....605  
 KANTROWITZ PINZA EMOSTATICA.....119/1  
 KAYE FACE LIFT FORBICI.....73

KEINSASSER LARINGOSCOPIO PER OPERAZIONE.....35  
 KEITH AGO.....223  
 KELLY DIVARICATORE.....164  
 KELLY FORBICI VASCOLARI.....61  
 KELLY GRIP DIVARICATORE.....142  
 KELLY PINZA EMOSTATICA.....106  
 KELLY PINZA PER POLIPI UTERINI.....585  
 KELLY PROCTOSCOPIO.....562, 563  
 KELLY-RANKIN PINZA EMOSTATICA.....106  
 KERN TENAGLIA PER OSSA.....244  
 KERRISON PINZA TAGLIENTE NASALE.....428  
 KEVORKIAN CURETTA PER BIOPSIA.....587  
 KEVORKIAN PINZA PER BIOPSIA.....589  
 KEVORKIAN-PACIFIC PINZA PER BIOPSIA.....592  
 KEY ELEVATORE.....282  
 KEYES TREFINA CUTANEA.....608  
 KIELLAND FORCIPE.....602  
 KIELLAND-LUIKART FORCIPE.....603  
 KILLIAN PER IRRIGAZIONE.....433, 433/1  
 KILLIAN CANNULA PER IRRIGAZIONE.....433, 433/1  
 KILLIAN FORBICE PER IL SETTO NASALE.....471  
 KILLIAN SGORBIA.....442/1  
 KILLIAN SPECOLO NASALE.....423  
 KILLIAN-CLAUS SGORBIA PER SETTO.....442/1  
 KILNER FORBICI PER CHIRURGIA.....54  
 KILNER PORT'AGHI.....212  
 KILNER SUPERCUT FORBICI.....72  
 KILNER UNCINO NASALE.....447/1  
 KILNER UNCINO PER LA PELLE.....608  
 KILNER-DOUGHTY APRIBOCCA.....456  
 KIRBY-ARTHUR PINZA PER IRIDE.....385  
 KIRK MARTELLO.....270  
 KIRSCHNER ARCO PER ESTENSIONE.....312  
 KIRSCHNER DIVARICATORE ADDOMINALE.....185  
 KIRSCHNER DIVARICATORE ADDOMINALE.....187  
 KIRSCHNER DIVARICATORE ADDOMINALE  
 COMPLETO.....187/1  
 KIRSCHNER PERFORATORE A MANO.....299  
 KIRSCHNER PERFORATORI FILIFORME.....306, 307  
 KIRSCHNER SPECILLO DI GUIDA SCANALATO.....221  
 KIRSCHNER US ARCO PER ESTENSIONE.....312  
 KIRSCHNER TELAIO PIEGABILE.....187  
 KIT PER AUTOPSIA IN ASTUCCIO DI LEGNO.....269  
 KLAPP DIVARICATORE.....150  
 KLEINERT-KUTZ PINZA PER AFFERRARE TENDINI.....294  
 KLEINERT-KUTZ PINZA SGORBIA.....237  
 KLEINERT-KUTZ UNCINO PER LA PELLE.....149  
 KLEINSASSER BRACCIO PORTALARINGOSCOPIO  
 STERNALE.....36  
 KLEINSASSER CANNULA D'INIEZIONE.....36  
 KLEINSASSER CANNULA D'ASPIRAZIONE.....36  
 KLEINSASSER PORTATORE DI LUCE FREDDA A FIBRE  
 DI VETRO.....36  
 KLEINSCHMIDT PINZA PER APPENDICE.....544  
 KLINKENBERGH-LOTH.....65/2  
 KNAPP COLTELLO PER IRIDE.....372  
 KNAPP CUCCHIAIO PER CATERATTA.....378  
 KNAPP IRIS FORBICI.....55  
 KNAPP UNCINO DIVARICATORE.....375  
 KNAPP-LUER PINZA PER TRACOMA.....393  
 KNIGHT PINZA PER SETTO NASALE.....425  
 KNOWLES FORBICI PER BENDAGGI.....70  
 KOCHER DIVARICATORE.....155  
 KOCHER DIVARICATORE.....159  
 KOCHER DIVARICATORE.....160  
 KOCHER DIVARICATORE.....163  
 KOCHER PINZA EMOSTATICA.....108  
 KOCHER PINZA INTESTINALE.....540  
 KOCHER SONDA PER GOZZO.....479  
 KOCHER SPATOLA VESCICALE.....552  
 KOCHER-LANGENBECK DIVARICATORE.....159  
 KOENIG AGO.....223  
 KOERTE DIVARICATORE.....162

KOGAN ENDOSPECOLO.....577  
 KÖNIG DIVARICATORE.....153  
 KÖNIG ELEVATORE PER OSSA.....284  
 KÖNIG PERIOTOTOMO.....276  
 KÖNIG SPECILLO DI GUIDA SCANALATO.....221  
 KOOS COLTELLO PER DURA MADRE.....335  
 KÖRTE SPATOLA ADDOMINALE ED INTESTINALE ....143/1  
 KRAUSE INSERTO.....471  
 KRAUSE SERRANODI.....412  
 KRAUSE SERRANODI.....433/2  
 KRAUSE-VOSS SERRANODI.....433/2  
 KRAYENBÜHL UNCINO PER NERVI.....336  
 KRISTELLER SPECOLO VAGINALE.....572  
 KROENIG ABBASSALINGUA.....451  
 KRONECKER AGO PER LEGATURE.....219  
 KUGLEN UNCINO.....376  
 KUHNIT RASCHIATOIO CORNEALE.....373  
 KÜMMEL SPATOLA ADDOMINALE.....144  
 KÜMMEL SPATOLA ADDOMINALE E INTESTINALE ....143/2  
 KÜNTSCHER ALESATORE PER FEMORE.....321  
 KÜNTSCHER ALESATORE PER L'APERTURA  
 DEL MIDOLLO.....321  
 KÜNTSCHER ESTRATTATORE.....322  
 KÜNTSCHER IMPATTATORE FINALE.....321

**L**  
 LA FORCE AGO PER CORPI ESTRANEI.....374  
 LA FORCE COLTELLO ADENOIDE.....450  
 LA GRANGE FORBICI GINGIVALI.....69  
 LABORDE DILATATORE TRACHEALE.....476  
 LACRIMAL CANNULA OCULISTICA.....394  
 LAHEY DIVARICATORE.....157  
 LAHEY PINZA EMOSTATICA.....119/2  
 LAHEY PINZA PER GOZZO.....479  
 LAHEY UNCINO ACUTO.....149  
 LAMA DI RASOIO.....45  
 LAMA DI RICAMBIO.....49  
 LAMA DI RICAMBIO, STERILE.....50  
 LAMA PER OSTEOTOMI.....266  
 LAMA PER SCALPELLI.....266  
 LAMBERT PINZA PER CALAZIO.....393  
 LAMBERT-KAY PINZA PER ANASTOMOSI.....505  
 LAMBERT-LOWMAN PINZA PER OSSA.....249  
 LAMBOTTE OSTEOTOMO.....261  
 LAMBOTTE TENAGLIA PER OSSA.....244  
 LAME PER BISTURI, STERILI.....42  
 LAME PER BISTURI, STERILI.....42  
 LAMPADA FRONTALE, CLAR.....22  
 LANCASTER BLEFAROSTATO.....371  
 LANDAU SPECOLO VAGINALE.....577  
 LANDOLT PINZA DA PRESA PER TUMORI.....341  
 LANE CACCIAVITE.....323, 324  
 LANE ELEVATORE PER OSSA.....290  
 LANE PIEGAPLACCHE.....325  
 LANE PINZA CHIRURGICA.....84  
 LANE PINZA FISSATELI.....133  
 LANE PINZA PORTAPLACCHE.....325  
 LANE PINZA PORTAVITI.....325  
 LANE PINZA STOMACALE.....547  
 LANE TENAGLIA PER OSSA.....244  
 LANE TRETOWAN ELEVATORE PER OSSA.....290  
 LANG DISSETTORE PER SACCO LACRIMALE.....378  
 LANGE INSERTO.....472  
 LANGE UNCINO PER LE PINNE NASALI.....448  
 LANGE-HOHMANN ELEVATORE PER OSSA.....286  
 LANGENBECK ANSA AURICOLARE.....409  
 LANGENBECK COLTELLO PER AMPUTAZIONE.....44  
 LANGENBECK COLTELLO PER CARTILAGINI.....47  
 LANGENBECK DIVARICATORE.....158  
 LANGENBECK DIVARICATORE.....159  
 LANGENBECK PERIOTOTOMO.....275  
 LANGENBECK PORT'AGHI.....213  
 LANGENBECK SEGA PER DITA.....296



LANGENBECK TENAGLIA PER OSSA .....	243	LOWMAN-HOGLUND PINZA PER OSSA .....	249	MATHIEU PINZA PER CORPI ESTRANEI .....	553/1
LANGENBECK-GREEN DIVARICATORE .....	153	LUBET-BARBON PINZA NASALE PER TAMPONI .....	424	MATHIEU PORT'AGHI .....	213
LARINGOSCOPIO MC INTOSH .....	29	LUC PINZA PER SETTO NASALE .....	426	MATHIEU SPECCHIO RETTALE .....	560
LARINGOSCOPIO MILLER .....	30	LUCAE AGO PER PARACENTESI .....	408	MATHIEU-OLSEN PORT'AGHI .....	212
LARINGOSCOPIO PER OPERAZIONE KLEINSASSER .....	35	LUCAE DIAPASON .....	404	MATSON PERIOSTOTOMO .....	279
LARINGOSCOPIO FOREGGER .....	29	LUCAE MARTELLINO .....	271	MATSON-ALEXANDER PERIOSTOTOMO .....	279
LARSEN PINZA PER AFFERRARE TENDINI .....	292	LUCAE PINZA AURICOLARE .....	410	MAUNDER APRIBOCCA DI LEGNO .....	459
LAWRENCE PINZA EMOSTATICA .....	119	LUCAE UNCINO .....	409	MAXI GRASPER PINZA PER BIOPSIA .....	593
LEBSCHKE SCALPELLO PER STERNO .....	267	LUER CANNULA TRACHEALE .....	479	MAYFIELD PINZA SGORBIA .....	238
LEES PINZA PER BRONCHI .....	504	LUER DIVARICATORE .....	140	MAYO ABBASSALINGUA .....	451
LEGATORE EMORROIDALE, MC GIVNEY .....	568	LUER PINZA SGORBIA .....	236	MAYO CUCCHIAIO PER CALCOLI BILIARI .....	534
LEGATORE EMORROIDALE, RUDD .....	568	LUER-KOERTE CUCCHIAIO PER CALCOLI BILIARI .....	533	MAYO FORBICI PER DISSEZIONE .....	52
LEGUE DIVARICATORE VESCICALE .....	553	LUJKART FORCIPE .....	603	MAYO PINZA .....	89
LEGUEU SPATOLA VESCICALE .....	552	LUJKART-BILL TRATTORE .....	604	MAYO SONDA PER CALCOLI BILIARI .....	534
LEKSELL(STILLE) PINZA SGORBIA .....	240	LUNDSGAARD SCLEROTOMO .....	373	MAYO SPILLONE PER STERILIZZAZIONE .....	227
LELAND-JONES PINZA VASCOLARE .....	494	LUNIATSCHKEK TAMPONATORE .....	465	MAYO SUPERCUT FORBICI .....	71
LEMPERT CURETTA TAGLIANTE .....	256			MAYO-ADAMS DIVARICATORE .....	171
LEMPERT ELEVATORE .....	420	M		MAYO-BLAKE PINZA PER CALCOLI BILIARI .....	531
LEMPERT PINZA SGORBIA .....	237	MAGILL PINZA PER INTRODUZIONE SONDE .....	28	MAYO-COLLINS DIVARICATORE .....	141
LERCHE PINZA DA PRESA .....	83	MAGLIA METALLICA PER ESTENSIONE .....	311	MAYO-COLLINS DIVARICATORE-SET .....	141
LERICHE PINZA EMOSTATICA .....	111	MALTZ (COTTLE) RASPA NASALE .....	444	MAYO-HABERISSER PINZA TORCIFILI .....	319
LERICHE SPATOLA ADDOMINALE E INTESTINALE .....	143/2	MALTZ RASPA NASALE .....	443	MAYO-HEGAR PORT'AGHI .....	209
LESINA .....	304	MANICI PER LAMA BISTURI .....	38	MAYON-GUYON PINZA EMOSTATICA .....	122
LESINA, PERTHES .....	304	MANICI PER LAMA BISTURI .....	39	MAYO-NOBLE FORBICI PER DISSEZIONE .....	52
LESTER PINZA FISSATRICE .....	389	MANICI PER LAMA BISTURI .....	39/1	MAYO-ROBSON PINZA INTESTINALE .....	541
LEVA PER CORPI ESTRANEI, BUCK .....	412	MANICI PER LAMA BISTURI .....	39/2	MAYO-STILLE FORBICI PER DISSEZIONE .....	52
LEVA PER CORPI ESTRANEI, QUIRE .....	412	MANICI PER LAMA BISTURI .....	40	MAYO-STILLE SUPERCUT FORBICI .....	71
LEVA PIEGAPLACCHE, LANE .....	325	MANICI PER LAMA BISTURI .....	41	MC DONALD ELEVATORE .....	283
LEVINSON AGO PER CORPI ESTRANEI .....	374	MANICO .....	266	MC INDOE CESOIA PER OSSA .....	241
LEWIN TENAGLIA PER OSSA .....	246	MANICO .....	266	MC INTOSH LARINGOSCOPIO .....	29
LEXER BABY FORBICI PER DISSEZIONE .....	53	MANICO .....	300	MC INTOSH LARINGOSCOPIO SET .....	31
LEXER FORBICI PER DISSEZIONE .....	53	MANICO A BATTERIA PER LUCE CALDA .....	32	MC KENZIE PERFORATORE .....	299
LEXER MINI SGORBIA .....	263	MANICO A BATTERIA PER LUCE CALDA .....	34	MCULLOUGH PINZA PER STRABISMO .....	385
LEXER OSTEOTOMO .....	263	MANICO A BATTERIA PER LUCE FREDDA .....	33	MCGEE MIKRO-PINZA AURICOLARE .....	414
LEYLA SISTEMA DI FISSAGGIO .....	368, 368/1, 368/2, 368/3, 368/4	MANICO A T, HUDSON .....	300	MCGEE UNCINO .....	419
LICHTENBERG PORT'AGHI .....	213	MANICO CON ATTACCO RAPIDO .....	301	MCGIVNEY LEGATORE EMORROIDALE .....	568
LICHTWITZ CANNULA .....	433	MANICO D'ASPIRAZIONE WULLSTEIN .....	338	MCGIVNEY PINZA EMORROIDALE .....	568
LICHTWITZ TREQUARTO PER SENO MASCELLARE .....	204	MANICO PER STRUMENTI MICROLARINGEI .....	475	MCINDOE FORBICI PER CARTILAGINE .....	65/1
LIEBERMANN BLEFAROSTATO .....	371	MANICO UNIVERSALE, HUBER .....	472	MCINDOE PINZA CHIRURGICA .....	85
LIMA PER OSSA .....	294	MANO DI PIOMBO .....	250	MCINTYRE CANNULA OCULISTICA .....	394
LIMA PER OSSA .....	612/1	MARCATORE, CONNIN-AMSLER .....	380	MCIVOR APRIBOCCA .....	457
LIMETTA PER LE UNGHIE .....	610	MARQUARDT PINZA SGORBIA .....	239	MCKENY ELEVATORE PER SETTO .....	437
LISTER FORBICI PER BENDAGGI .....	69/1	MARSHKIK PINZA PER TONSILLE .....	468	MCKENZIE PINZA POSA CLIPS .....	326
LISTER SUPERCUT FORBICI .....	72	MARTEL PINZA DA PRESA .....	110	MCCLEAN FORCIPE .....	603
LISTER(SINUS) TUPFERZA .....	137	MARTELLO DI PERCUSSIONE, BABINSKY .....	24	MCCLEAN-LUIKART FORCIPE .....	603
LISTER-BURCH BLEFAROSTATO .....	370	MARTELLO DI PERCUSSIONE, BERLINER .....	24	MCCLEAN-TUCKER-LUIKART FORCIPE .....	603
LISTON CESOIA PER OSSA .....	241	MARTELLO DI PERCUSSIONE, BUCK .....	24	MCPHERSON PINZA PER FILO .....	392
LISTON COLTELLO PER AMPUTAZIONE .....	44	MARTELLO DI PERCUSSIONE, TAYLOR .....	24	MEAD MARTELLO .....	271
LITTAUER FORBICI PER LEGATURE .....	66	MARTELLO DI PERCUSSIONE, TROEMNER .....	24	MEAD PINZA SGORBIA .....	235
LITTAUER PINZA AURICOLARE .....	411	MARTELLO IN PLASTICA .....	271	MEEKER PINZA EMOSTATICA .....	119
LITTAUER PINZA DEPIILATORIA .....	395	MARTELLO, BERGMANN .....	272	MEHDORN CLIPS PER VASI .....	362
LITTAUER PINZA PER POLIPI .....	425	MARTELLO, COLLIN .....	270	MEHDORN PINZA POSA CLIPS .....	362
LITTLE DIVARICATORE .....	157	MARTELLO, COTTLE .....	273	MELLINGER BLEFAROSTATO .....	370
LITTLEL IRIS FORBICI .....	55	MARTELLO, GERZOG .....	270	MELLINGER-AXENFELD BLEFAROSTATO .....	370
LITTLEWOOD PINZA PER AFFERRARE INTESTINI .....	538	MARTELLO, HAJEK .....	273	MENGHINI AGO PER BIOPSIA .....	206
LOCKHART-MUMMERY SPECILLO PER FISTOLE .....	200	MARTELLO, HEATH .....	273	MERCEDES DIVARICATORE PER TORACE .....	489
LOCKLIN FORBICE GINGIVALI .....	69	MARTELLO, KIRK .....	270	MERIAM PINZA DENTALE .....	93
LOCKWOOD-ALLIS PINZA PER AFFERRARE INTESTINI .....	538	MARTELLO, LUCAE .....	271	METZENBAUM FINO TC FORBICI PER DISSEZIONE .....	53/1
LONDON-COLLEGE PINZA DENTALE .....	93	MARTELLO, MEAD .....	271	METZENBAUM FORBICI PER CHIRURGIA .....	54
LOPEZ-REINKE DISSETTORE PER TONSILLE .....	465	MARTELLO, OMBREDANNE .....	273	METZENBAUM FORBICI PER DISSEZIONE .....	53/1
LORENZ FORBICI PER BENDAGGI .....	70	MARTELLO, PARTSCH .....	271	METZENBAUM PORT'AGHI .....	211
LORNA PINZA FISSATELI .....	133	MARTELLO, QUISLING .....	271	METZENBAUM SUPERCUT FORBICI .....	71
LOUTE STRUMENTO TENDIFILI .....	315	MARTELLO, WILLIGER .....	271	METZENBAUM TC FORBICI PER DISSEZIONE .....	53/1
LOVE DIVARICATORE .....	465	MARTIN DIVARICATORE .....	175/1	MEYERDING DIVARICATORE .....	157
LOVE UNCINO PER NERVI .....	329/2	MARTIN FORBICI PER CARTILAGINE .....	65/1	MEYERDING DIVARICATORE .....	177
LOVE UNCINO PER RADICI DEI NERVI .....	330	MARTIN ISTEROMETRO .....	586	MEYERDING DIVARICATORE .....	180
LOVE-GRUENWALD PINZA TAGLIANTE PER		MARTIN PELVIMETRO .....	605	MEYHOEFER CURETTA DA CALAZIO .....	377
LAMINECTOMIA .....	340	MARTIN TENAGLIA PER OSSA .....	246	MICHEL AGRAFES .....	224
LOVELACE PINZA EMOSTATICA .....	109	MARTINI CURETTA TAGLIANTE .....	257	MICHEL PINZA PER AGRAFES .....	224
LOVELACE PINZA PER AFFERRARE IL POLMONE .....	490	MASING-NEIVERT UNCINO NASALE .....	447/1	MICHEL SPECCHIO LARINGEO .....	423
LOWER PINZA EMOSTATICA .....	120	MASSON PORT'AGHI .....	210	MICRO FORBICI .....	76
LOWMAN PINZA PER OSSA .....	249	MASTIN PINZA MUSCOLARE .....	479	MICRO FORBICI .....	77
		MATHIEU DIVARICATORE .....	141	MICRO FORBICI .....	78

MICRO FORBICI AURICOLARI, BELLUCCI.....	413	MUSEUX PINZA PER ABBASSARE IL COLLO		O'SULLIVAN-O'CONNOR SPECOLO VAGINALE.....	576
MICRO FORBICI AURICOLARI, SHEA.....	413	DELL'UTERO.....	583	OTIS URETROTOMO.....	553
MICRO FORBICI, GOMEL.....	80	MYLES PINZA NASALE.....	427	OVERHOLT PINZA EMOSTATICA.....	114
MICRO FORBICI, HEPP-SCHEIDEL.....	78			OVERHOLT-BABY PINZA EMOSTATICA.....	114
MICRO FORBICINE, BELLUCCI.....	417	N		OVERHOLT-GEISENDOERFER PINZA EMOSTATICA.....	114
MICRO FRIEDMANN PINZA SGORBIA.....	234	NABATOFF SET PER VARICI IN SCATOLA DI METALLO ...	201	OVERHOLT-MIXER PINZA EMOSTATICA.....	115
MICRO PINZA AURICOLARE.....	415	NAEGELE FORCIPE.....	602		
MICRO PINZA AURICOLARE A CUCCHIAIO		NAGER AGO PER TONSILLE.....	466	P	
WULLSTEIN.....	416	NAGER DIVARICATORE.....	465	PADELLA.....	621
MICRO-HARTMANN PINZA EMOSTATICA.....	104	NEFF COLTELLO PER MENISCO.....	292	PARK BLEFAROSTATO.....	371
MICROPINZA CHIRURGICA, GOMEL.....	96	NEGUS PINZA PER TONSILLE.....	467	PARKER DIVARICATORE.....	139
MICROVASCULAR PORT'AGHI.....	210	NEGUS SUPPORTO PER PETTO.....	459	PARTSCH MARTELLO.....	271
MIDDELDORPF DIVARICATORE.....	160	NEIVERT PORT'AGHI.....	208	PARTSCH SCALPELLO.....	259
MIDDLETON-JANSEN PINZA PER SETTO NASALE.....	430	NEIVERT-ANDERSON OSTEOTOMO NASALE.....	442	PARTSCH SGORBIA.....	259
MIKRO COLTELLO FALCATO.....	475	NELATON SPECILLO SCANALATO.....	199	PASSOW PESTELLO DA TAMPONARE.....	260
MIKRO SEPERATORE.....	475	NELSON AGO PER LEGATURE.....	219	PATON DISETTORE CORNEALE.....	373
MIKRO UNCINO.....	475	NELSON STANDARD TREQUARTO.....	204	PAUFIQUE COLTELLO PER CHERATOPLASTICA.....	373
MIKRO-PINZA AURICOLARE.....	413	NELSON TREQUARTO.....	205	PAUFIQUE PINZA PER FILO.....	392
MIKRO-PINZA AURICOLARE, COS.....	414	NEONATAL PINZA VASCOLARE CASTANEDA.....	527	PAYR SCHIACCIATORE PER L'INTESTINO E LO	
MIKRO-PINZA AURICOLARE, DIETER.....	414	NEWS DIVARICATORE TRACHEALE.....	477	STOMACO.....	548
MIKRO-PINZA AURICOLARE, GREVEN.....	414	NISSEN PINZA EMOSTATICA.....	113	PAYR SPECILLO DI GUIDA SCANALATO.....	221
MIKRO-PINZA AURICOLARE, HAUGH.....	414	NORFOLK-NORWICH DIVARICATORE.....	172	PEAN PINZA DA PRESA.....	110
MIKRO-PINZA AURICOLARE, JUERS.....	414	NORTHBENT FORBICI PER LEGATURE.....	66	PEAN PINZA EMOSTATICA.....	108
MIKRO-PINZA AURICOLARE, MCGEE.....	414	NOTO PINZA PER POLIPI UTERINI.....	585	PECK-JOSEPH FACE LIFT FORBICI.....	74
MIKULICZ DIVARICATORE.....	163	NOVA, SFIGMOMANOMETRO.....	6,7	PECK-JOSEPH FACE LIFT FORBICI.....	74
MIKULICZ PINZA INTESTINALE.....	543	NOVAK CURETTA PER BIOPSIA.....	587	PEDESON SPECOLO VAGINALE.....	570
MIKULICZ PINZA PERITONEALE.....	123	NOYES FORBICI OCULISTICHE.....	75	PEENFIELD DISSETTORE.....	333
MIKULICZ-BABY PINZA PERITONEALE.....	123	NOYES PINZA PER POLIPI.....	425	PEERS PINZA FISSATELI.....	132
MILLER LARINGOSCOPIO.....	30			PEET PINZA PER SCHEGGE.....	92
MILLER RASPA NASALE.....	444	O		PEET RASPA NASALE.....	446
MILLIGAN DURA DISSETTORE.....	332	OBWEGESER AGO DI INTRODUZIONE.....	463	PELKMANN PINZA PER MEDICATURA.....	137
MILLIN DIVARICATORE VESICALE.....	552	OBWEGESER AGO DI INTRODUZIONE.....	463/3	PELVIMETRO, COLLIER.....	605
MILLIN DIVARICATORE VESICALE.....	553	OBWEGESER DIVARICATORE.....	460, 461	PELVIMETRO, COLLIN.....	605
MILLIN PINZA CAPSULARE DA PRESA.....	551	OBWEGESER OSTEOTOMO A LAMA.....	464/1	PELVIMETRO, MARTIN.....	605
MILLIN PINZA DA PRESA PER LA PROSTATA.....	551	OBWEGESER PERIOSTOTOMO.....	461, 462, 463	PENNINGTON ELEVATORE PER SETTO.....	438
MINI MANICO CON ATTACCO RAPIDO.....	301	OCCHIALI NISTAGMO FRENZEL.....	20	PENNINGTON PINZA EMOSTATICA.....	109
MINI-LAMBOTTE OSTEOTOMO.....	262	OCHSNER TREQUARTO.....	205	PERCY RETRATTORE.....	296
MINIMUS II, SFIGMOMANOMETRO.....	11	O'CONNER UNCINO PER IRIDE.....	375	PERFORATORE A MANO, BUNELL.....	299
MINIMUS III, SFIGMOMANOMETRO.....	12	OEHLER PINZA CHIRURGICA.....	81/1	PERFORATORE A MANO, HUDSON KPLT.....	299
MIXTER PINZA CURVA AD "S".....	116	OLDBERG PINZA TAGLIENTE PER LAMINECTOMIA.....	341	PERFORATORE A MANO, KIRSCHNER.....	299
MIXTER PINZA PER CALCOLI BILIARI.....	531	OLIO PER STRUMENTI INSTRU CARE.....	634	PERFORATORE A MANO, MOORE.....	298
MIXTER-BABY PINZA EMOSTATICA.....	119/1	OLIVA NASALE POLITZER.....	406	PERFORATORE A MANO, RALK.....	300
MIXTER-O'SHAUGNESSY PINZA EMOSTATICA.....	119/2	OLIVECRONA DURA DISSETTORE.....	332	PERFORATORE A MANO, STILLE.....	298
MOD. BONN PINZA PER IRIDE.....	387	OLIVECRONA PINZA SGORBIA.....	237	PERFORATORE A MANO, STILLE-SHERMAN.....	298
MOD. TÜBINGEN PINZA PER IRIDE.....	387	OLIVECRONA SEGA IN FILO D'ACCIAIO.....	332	PERFORATORE ELICOIDALE.....	302
MOD.MÜNCHEN CURETTA PER BIOPSIA.....	587	OLIVECRONA SPATOLA CEREBRALE.....	336	PERFORATORE INTRAMIDOLLARE.....	322
MOD.VIENNA SPECOLO NASALE.....	421	OLIVECRONA-TOENNIS (SCOVILLE).....	326	PERFORATORE, CRUTCHFIELD.....	327
MODELLATORE PER CHIODI, BENDER.....	322	OLIVECRONA-TOENNIS PINZA POSA CLIPS.....	326	PERFORATORE, CUSHING.....	299
MODELLO RUSSO, PINZA DA PRESA.....	85	OLLIER DIVARICATORE.....	162	PERFORATORE, ERRICO.....	299
MODELLO STRASSBURG PINZA CHIRURGICA.....	89	OLSEN-HEGAR PORT'AGHI.....	212	PERFORATORE, MC KENZIE.....	299
MOELTGEN GONIOMETRO.....	25	OMBREDANNE MARTELLO.....	273	PERFORATORE, SMELLIE.....	607
MOGEN STRUMENTO PER CIRCONCISIONE.....	556	OSTEOTOME, COTTLE.....	440	PERFORATORI FILIFORME KIRSCHNER.....	306, 307
MOLLISON DIVARICATORE.....	171	OSTEOTOMI.....	259	PERIOSTOTOMO.....	279
MOLT PERIOSTOTOMO.....	276	OSTEOTOMI.....	464	PERIOSTOTOMO MOLT.....	276
MONOPOLAR ELEKTRODEN ANSAN.....	628, 629	OSTEOTOMI EPKER.....	464/2	PERIOSTOTOMO SELDIN.....	277
MOOR CUCCHIAIO PER CALCOLI BILIARI.....	532	OSTEOTOMO A LAMA OBWEGESER.....	464/1	PERIOSTOTOMO, ADSON.....	282
MOORE PERFORATORE A MANO.....	298	OSTEOTOMO LEXER.....	263	PERIOSTOTOMO, ALEXANDER.....	276
MOORFIELD PINZA PER SUTURA.....	392	OSTEOTOMO MINI-LAMBOTTE.....	262	PERIOSTOTOMO, COBB.....	280
MORGAN PROCTOSCOPIO.....	565	OSTEOTOMO NASALE NEIVERT-ANDERSON.....	442	PERIOSTOTOMO, DINGMANN.....	463
MORITZ-SCHMIDT ABBASSALINGUA.....	452	OSTEOTOMO PER SETTO, COTTLE.....	440	PERIOSTOTOMO, DOYEN.....	278
MORRIS DIVARICATORE.....	164	OSTEOTOMO PER SETTO, FOMON.....	441	PERIOSTOTOMO, FARABEUF.....	274
MORRIS-DEBAKEY PINZA AORTA.....	506	OSTEOTOMO PER SETTO, SHEEHAN.....	441	PERIOSTOTOMO, FARABEUF-COLLIN.....	274
MORSE DIVARICATORE COSTALE.....	484	OSTEOTOMO, HIBBS.....	265	PERIOSTOTOMO, FOMON.....	277
MORSE-FAVALORO DIVARICATORE COSTALE.....	484	OSTEOTOMO, LAMBOTTE.....	261	PERIOSTOTOMO, JOSEPH.....	277
MORSETTO PER SISTEMA BRACCIO.....	189	OSTEOTOMO, SMITH-PETERSEN.....	261	PERIOSTOTOMO, KOENIG.....	276
MOYNIHAN PINZA EMOSTATICA.....	120	OSTEOTOMO, STILLE.....	260	PERIOSTOTOMO, LAMBOTTE.....	274
MOYNIHAN PINZA FISSATELI.....	133	OSTEOTOMO PER SETTO RUBIN.....	440	PERIOSTOTOMO, LANGENBECK.....	275
MOYNIHAN SONDA PER CALCOLI BILIARI.....	532	OSTROEM PINZA TAGLIENTE PER SETTO NASALE.....	430	PERIOSTOTOMO, MATSON.....	279
MUELLER BLEFAROSTATO.....	371	OSTROEM PINZA TAGLIENTE PER SETTO NASALE.....	430	PERIOSTOTOMO, MATSON-ALEXANDER.....	279
MÜLLER CLIPS PER VASI.....	364, 365	O'SULLIVAN-O'CONNOR DIVARICATORE		PERIOSTOTOMO, OBWEGESER.....	461, 462, 463
MURDOCK BLEFAROSTATO.....	370	ADDOMINALE.....	181	PERIOSTOTOMO, SEMB.....	278
MURPHY DIVARICATORE.....	156	O'SULLIVAN-O'CONNOR DIVARICATORE		PERIOSTOTOMO, WILLIGER.....	276
MURPHY-LANE ELEVATORE.....	283	ADDOMINALE.....	181	PERKINS DIVARICATORE.....	168

PERTHES LESINA.....	304	PINZA CHIRURGICA, ADSON-BROWN .....	82	PINZA EMOSTATICA, KELLY-RANKIN.....	106
PESTALOZZA CURETTA PER ABORTO .....	606	PINZA CHIRURGICA, BONNEY .....	88	PINZA EMOSTATICA, LAHEY .....	119/2
PESTELLO DA TAMPONARE, PASSOW .....	260	PINZA CHIRURGICA, BROPHY .....	84	PINZA EMOSTATICA, LAWRENCE .....	119
PETZ APPARECCHIATURA DI SUTURA .....		PINZA CHIRURGICA, CUSHING .....	83	PINZA EMOSTATICA, LERICHE .....	111
GASTRO-INTESTINALE .....	549	PINZA CHIRURGICA, FERRIS-SMITH.....	84	PINZA EMOSTATICA, LOVELACE .....	109
PHANEUF PINZA PERITONEALE .....	123	PINZA CHIRURGICA, GILLIES .....	86	PINZA EMOSTATICA, LOWER .....	120
PIERCE ELEVATORE PER SETTO .....	438	PINZA CHIRURGICA, LANE .....	84	PINZA EMOSTATICA, MAYER-GUYON .....	122
PIERCE TREQUARTO PER SENO MASCELLARE .....	204	PINZA CHIRURGICA, MCINDOE .....	85	PINZA EMOSTATICA, MEEKER .....	119
PIFFARD CURETTA PER LUPUS .....	608	PINZA CHIRURGICA, MOD.USA .....	81/1	PINZA EMOSTATICA, MICRO-HARTMANN.....	104
PILLING PINZA APPLICATORE CLIPS SMAL .....	524, 525	PINZA CHIRURGICA, OEHLER TC.....	81/1	PINZA EMOSTATICA, MIXTER .....	119/1
PINARD STETOSCOPIO .....	23	PINZA CHIRURGICA, SEMKEN .....	86	PINZA EMOSTATICA, MIXTER-BABY .....	119/1
PINZA PER CORPI ESTRANEI, HARTMANN .....	412	PINZA CHIRURGICA, STILLE .....	81/1	PINZA EMOSTATICA, MOYNIHAN .....	120
PINZA PER CORPI ESTRANEI, HARTMANN-HOFFMANN .....	412	PINZA CHIRURGICA, TAYLOR .....	87	PINZA EMOSTATICA, O'SHAUGNESSY .....	119/2
PINZA PER CORPI ESTRANEI, HARTMANN-WULLSTEIN .....	412	PINZA CHIRURGICA, TAYLOR .....	615	PINZA EMOSTATICA, PENNINGTON.....	109
PINZA VASCOLARE, WANGENSTEEN.....	89	PINZA CURVA AD "S" MIXTER.....	116	PINZA EMOSTATICA, PROVIDENCE-HOSPITAL.....	106
PINZA AD ASTA TUBOLARE PER MICROCHIRURGIA.....	474	PINZA DA PRESA.....	316,317	PINZA EMOSTATICA, ROBERTS .....	117
PINZA ANATOMICA STANDARD .....	81	PINZA DA PRESA COTTELE .....	410	PINZA EMOSTATICA, ROCHESTER-CARMALT .....	109
PINZA ANATOMICA, ADSON.....	82	PINZA DA PRESA PER FILI KIRSCHNER.....	305	PINZA EMOSTATICA, ROCHESTER-OCHSNER .....	108
PINZA ANATOMICA, ADSON MICRO.....	82	PINZA DA PRESA PER LA PROSTATA, MILLIN.....	551	PINZA EMOSTATICA, ROCHESTER-PEAN .....	108
PINZA ANATOMICA, BONNEY .....	88	PINZA DA PRESA PER TONSILLE ABRAHAM.....	468	PINZA EMOSTATICA, RUMEL .....	117
PINZA ANATOMICA, BONNEY .....	88	PINZA DA PRESA PER TUMORI, LANDOLT .....	341	PINZA EMOSTATICA, SAROT .....	118
PINZA ANATOMICA, BROPHY .....	84	PINZA DA PRESA, COLLIN-DUVAL .....	85	PINZA EMOSTATICA, SPENCER-WELLS .....	109
PINZA ANATOMICA, CUSHING.....	83	PINZA DA PRESA, DURANTE .....	88	PINZA EMOSTATICA, STILLE .....	122
PINZA ANATOMICA, GERALD .....	86	PINZA DA PRESA, DUVAL .....	85	PINZA EMOSTATICA, TOENNIS.....	117
PINZA ANATOMICA, MCINDOE.....	85	PINZA DA PRESA, GRAEFE .....	83	PINZA EMOSTATICA, ZENKER .....	118
PINZA ANATOMICA, BONNEY .....	88	PINZA DA PRESA, LERCHE .....	83	PINZA EMOSTATICA, OVERHOLT-BABY .....	114
PINZA ANATOMICA, GERALD .....	86	PINZA DA PRESA, MARTEL .....	110	PINZA EMOSTATICA, OVERHOLT-GEISSENDÖRFER.....	114
PINZA ANATOMICA, MCINDOE.....	85	PINZA DA PRESA, MODELLO RUSSO .....	85	PINZA EMOSTATICA, OVERHOLT-MIXTER .....	115
PINZA ANATOMICA, BONNEY .....	88	PINZA DA PRESA, PEAN.....	110	PINZA FISSATELI .....	133
PINZA ANATOMICA, POTT-SMITH .....	81	PINZA DA PRESA, PRATT.....	110	PINZA FISSATELI BALL AND SOCKET .....	133
PINZA ANATOMICA, SEMKEN .....	86	PINZA DA PRESA, WILLET MARTEL .....	110	PINZA FISSATELI, BACKHAUS .....	132
PINZA ANATOMICA, STILLE .....	81	PINZA DENTALE LONDON-COLLEGE .....	93	PINZA FISSATELI, BERNHARD .....	133
PINZA ANATOMICA, TAYLOR.....	87	PINZA DENTALE MERIAM .....	93	PINZA FISSATELI, DOYEN .....	133
PINZA ANATOMICA, TC.....	81	PINZA DEPILATORIA BEER .....	395	PINZA FISSATELI, JONES .....	132
PINZA ANEURISMA DEBAKEY-BAHNSON .....	506	PINZA DEPILATORIA, BARRAQUER .....	395	PINZA FISSATELI, LANE .....	133
PINZA AORTA DIETRICH .....	510	PINZA DEPILATORIA, DOUGLAS .....	395	PINZA FISSATELI, LORNA .....	133
PINZA AORTA MORRIS-DEBAKEY .....	506	PINZA DEPILATORIA, GRADLE .....	395	PINZA FISSATELI, MOYNIHAN .....	133
PINZA ATRAUMATICA BULLDOG, DE BAKEY .....	100	PINZA DEPILATORIA, LITTAUER .....	395	PINZA FISSATELI, PEERS.....	132
PINZA ATRAUMATICA BULLDOG, GLOVER.....	100	PINZA DEPILATORIA, REDA .....	395	PINZA FISSATELI, ROEDER.....	132
PINZA ATRAUMATICA IN TITANIO, DEBAKEY .....	99	PINZA EMORROIDALE FERGUSSON .....	109	PINZA FISSATELI, SCHADEL .....	132
PINZA ATRAUMATICA PER NEONATI E BAMBINI .....	523	PINZA EMORROIDALE, MCGIVNEY .....	568	PINZA FISSATELI, TOHOKU .....	132
PINZA ATRAUMATICA TC DEBAKEY .....	99	PINZA EMOSTATICA BIRKETT .....	116	PINZA FISSATRICE, BARRAQUER .....	390
PINZA AURICOLARE, HARTMANN .....	411	PINZA EMOSTATICA BRIDGE.....	116	PINZA FISSATRICE, CASTROVIEJO .....	390
PINZA AURICOLARE, HEYMANN-KNIGHT .....	425	PINZA EMOSTATICA COLLER-CRILE .....	106	PINZA FISSATRICE, ELSCHNIG .....	389
PINZA AURICOLARE, JANSEN .....	424	PINZA EMOSTATICA DEBAKEY-MOSQUITO .....	509	PINZA FISSATRICE, GRAEFE .....	389
PINZA AURICOLARE, LITTAUER .....	411	PINZA EMOSTATICA DEBAKEY-PEAN .....	513	PINZA FISSATRICE, GREEN .....	390
PINZA AURICOLARE, LUCAE .....	410	PINZA EMOSTATICA DEBAKEY-RANKIN .....	512	PINZA FISSATRICE, LESTER.....	389
PINZA AURICOLARE, TILLEY .....	411	PINZA EMOSTATICA FUCHSIG .....	113	PINZA INTESTINALE BRUNNER .....	543
PINZA AURICOLARE, TROELTSCH.....	424	PINZA EMOSTATICA KANTROWITZ .....	119/1	PINZA INTESTINALE PER BIOPSIA, TURREL .....	567
PINZA AURICOLARE, WILDE (TROELTSCH) .....	410	PINZA EMOSTATICA KOCHER .....	108	PINZA INTESTINALE PER BIOPSIA, YEOMAN .....	566, 567
PINZA AURICOLA, HARKEN.....	503	PINZA EMOSTATICA NISSEN .....	113	PINZA INTESTINALE SCUDDER .....	541
PINZA BIPOLARE.....	630, 631	PINZA EMOSTATICA OVERHOLT .....	114	PINZA INTESTINALE, BABY-KOCHER .....	540
PINZA BIPOLARE A BAIONETTA.....	631, 632	PINZA EMOSTATICA PEAN.....	108	PINZA INTESTINALE, DOYEN .....	540
PINZA CAPSULARE DA PRESA, MILLIN.....	551	PINZA EMOSTATICA WIKSTROEM .....	117	PINZA INTESTINALE, FEHLAND .....	542
PINZA CAPSULARE, ARRUGA .....	391	PINZA EMOSTATICA, ADSON .....	112	PINZA INTESTINALE, KOCHER.....	540
PINZA CAPSULARE, CASTROVIEJO .....	391	PINZA EMOSTATICA, ADSON-BABY .....	113	PINZA INTESTINALE, MAYO-ROBSON .....	541
PINZA CAPSULARE, ELSCHNIG .....	391	PINZA EMOSTATICA, BAINBRIDGE .....	119/2	PINZA INTESTINALE, MIKULICZ .....	543
PINZA CAPSULARE, FUCHS.....	391	PINZA EMOSTATICA, BENGOLEA .....	112	PINZA INTESTINALE, RESANO .....	542
PINZA CAPSULARE, GILL-ARRUGA .....	390	PINZA EMOSTATICA, CRAFOORD .....	118	PINZA INTESTINALE, STONE-WATT .....	545
PINZA CAPSULARE, HESS .....	391	PINZA EMOSTATICA, CRAFOORD-SELLORS.....	119	PINZA MAYO .....	89
PINZA CAPSULARE, KALT .....	391	PINZA EMOSTATICA, CRILE .....	107	PINZA MODELLO STRASSBURG .....	89
PINZA CAPSULARE, SCHWEIGGER.....	391	PINZA EMOSTATICA, CRILE-RANKIN .....	107	PINZA MUSCOLARE, BERKE .....	389
PINZA CAPSULARE, TERSON .....	391	PINZA EMOSTATICA, DANDY .....	109	PINZA MUSCOLARE, MASTIN .....	479
PINZA CARDIOVASCOLARE ATRAUMATICA .....	526	PINZA EMOSTATICA, DESJARDINS .....	121	PINZA MUSCOLARE, PRINCE .....	387
PINZA CARDIOVASCOLARE ATRAUMATICA COOLEY .....	518, 519, 522	PINZA EMOSTATICA, GEMINI .....	115	PINZA NASALE GRAIG .....	426
PINZA CARDIOVASCOLARE ATRAUMATICA DERRA.....	515	PINZA EMOSTATICA, GRAY .....	121	PINZA NASALE PER TAMPONI LUBET-BARBON .....	424
PINZA CARDIOVASCOLARE ATRAUMATICA GREGORY.....	517	PINZA EMOSTATICA, GUYON .....	122	PINZA NASALE PER TAMPONI WESTMACOTT .....	424
PINZA CHIRURGICA GERALD .....	87	PINZA EMOSTATICA, HALSTED-MOSQUITO .....	105	PINZA NASALE WEIL-BLAKESLEY .....	426
PINZA CHIRURGICA POTT-SMITH .....	81	PINZA EMOSTATICA, HARTMANN .....	104	PINZA NASALE, CAPLAN .....	428
PINZA CHIRURGICA STANDARD .....	81/1	PINZA EMOSTATICA, HEISS.....	112	PINZA NASALE, HARTMANN .....	427
PINZA CHIRURGICA WAUGH .....	83	PINZA EMOSTATICA, JACOBSON .....	105	PINZA NASALE, MYLES .....	427
PINZA CHIRURGICA, ADSON .....	82	PINZA EMOSTATICA, JOHNS-HOPKINS.....	120	PINZA NASALE, SCHMEDEN .....	427
PINZA CHIRURGICA, ADSON MICRO .....	82	PINZA EMOSTATICA, KELLY .....	106	PINZA NASALE, TAKAHASHI.....	427



PINZA NASALE, WATSON-WILLIAMS.....	428	PINZA PER AGRAFES, RICHTER-HEATH .....	224	PINZA PER IRIDE, GRAEFEE .....	382
PINZA NASALE, STRUYCKEN.....	427	PINZA PER ANASTOMOSI DEL RETTO, HAYES .....	545	PINZA PER IRIDE, HESS .....	384
PINZA OMBELICALE, COLLIN.....	605	PINZA PER ANASTOMOSI, BECK.....	516	PINZA PER IRIDE, KIRBY-ARTHUR.....	385
PINZA OMBELICALE, KANE.....	605	PINZA PER ANASTOMOSI, BECK.....	520	PINZA PER IRIDE, MOD. BONN.....	387
PINZA PER ABBASSARE IL COLLO DELL'UTERO CZERNY.....	584	PINZA PER ANASTOMOSI, COOLEY-DERRA .....	519	PINZA PER IRIDE, MOD. TUEBINGEN.....	387
PINZA PER ABBASSARE IL COLLO DELL'UTERO SCHRÖDER .....	583, 584	PINZA PER ANASTOMOSI, DE MARTEL-WOLFSON .....	546	PINZA PER IRIDE, TROUTMAN.....	389
PINZA PER ABBASSARE IL COLLO DELL'UTERO, BARRET.....	582	PINZA PER ANASTOMOSI, DEBAKEY .....	505	PINZA PER IRIDE, STEVENS.....	383
PINZA PER ABBASSARE IL COLLO DELL'UTERO, BRAUN .....	582	PINZA PER ANASTOMOSI, LAMBERT-KAY .....	505	PINZA PER ISTERECTOMIA SEGOND.....	125
PINZA PER ABBASSARE IL COLLO DELL'UTERO, DUPLAY.....	582	PINZA PER AORTA PEDIATRICA, SUBRAMANIAN-MINIATURE .....	521	PINZA PER ISTERECTOMIA SEGOND-LANDAU .....	125
PINZA PER ABBASSARE IL COLLO DELL'UTERO, HULKA.....	583	PINZA PER AORTA, WEBER.....	501	PINZA PER ISTERECTOMIA, HEANEY.....	126
PINZA PER ABBASSARE IL COLLO DELL'UTERO, IOWA.....	584	PINZA PER APPENDICE, ALLEN.....	544	PINZA PER ISTERECTOMIA, HEANY-BALLENTINE.....	127
PINZA PER ABBASSARE IL COLLO DELL'UTERO, JACOBS.....	583	PINZA PER APPENDICE, KLEINSCHMIDT.....	544	PINZA PER ISTERECTOMIA, ROGERS.....	127
PINZA PER ABBASSARE IL COLLO DELL'UTERO, JARCHO.....	583	PINZA PER BIOPSIA BABY BURKE.....	590	PINZA PER ISTERECTOMIA, WERTHEIM.....	124
PINZA PER ABBASSARE IL COLLO DELL'UTERO, MUSEUX.....	583	PINZA PER BIOPSIA BABY TISCHLER.....	592	PINZA PER ISTERECTOMIA, WERTHEIM.....	128
PINZA PER ABBASSARE IL COLLO DELL'UTERO, PRATT.....	584	PINZA PER BIOPSIA SCHUMACHER.....	588, 589	PINZA PER LACERAZIONE UNGHIE, RADOLF .....	297
PINZA PER ABBASSARE IL COLLO DELL'UTERO, SCHROEDER.....	583, 584	PINZA PER BIOPSIA TOWNSEND.....	591	PINZA PER MEDICATURA.....	135
PINZA PER ABBASSARE IL COLLO DELL'UTERO, SCHROEDER (POZZI).....	582	PINZA PER BIOPSIA, ALEXANDER.....	589	PINZA PER MEDICATURA, BRYANT.....	137
PINZA PER ABBASSARE IL COLLO DELL'UTERO, SKENE.....	582	PINZA PER BIOPSIA, BURKE.....	590	PINZA PER MEDICATURA, CHERON.....	137
PINZA PER ABBASSARE IL COLLO DELL'UTERO, TEALE.....	583	PINZA PER BIOPSIA, SCHUBERT.....	590	PINZA PER MEDICATURA, COLLIN.....	137
PINZA PER ABBASSARE IL COLLO DELL'UTERO, STAUDE-MOORE.....	582	PINZA PER BIOPSIA, EPPENDORFER.....	590	PINZA PER MEDICATURA, DUPLAY.....	134
PINZA PER ABORTO, SAENGER.....	606	PINZA PER BIOPSIA, FAURE.....	588	PINZA PER MEDICATURA, FOERSTER.....	136
PINZA PER ABORTO, WINTER.....	606	PINZA PER BIOPSIA, KEVORK-PACIFIC.....	592	PINZA PER MEDICATURA, GROSS-MAIER.....	134
PINZA PER AFFERRARE IL POLMONE, LOVELACE.....	490	PINZA PER BIOPSIA, KEVORKIAN.....	589	PINZA PER MEDICATURA, LISTER (SINUS).....	137
PINZA PER AFFERRARE INTESTINI DOYEN-BABY.....	540	PINZA PER BIOPSIA, KEVORKIAN.....	591	PINZA PER MEDICATURA, PELKMANN.....	137
PINZA PER AFFERRARE INTESTINI LOCKWOOD-ALLIS .....	538	PINZA PER BIOPSIA, MAXI GRASPER.....	593	PINZA PER MEDICATURA, RAMPLEY.....	136
PINZA PER AFFERRARE INTESTINI, ALLIS.....	537	PINZA PER BIOPSIA, SCHUBERT.....	588	PINZA PER MEDICATURA, SIMS-MAIER.....	134
PINZA PER AFFERRARE INTESTINI, ALLIS-ADAIR.....	537	PINZA PER BIOPSIA, THOMAS-GAYLOR .....	588	PINZA PER MEDICATURA, ULRICH.....	135
PINZA PER AFFERRARE INTESTINI, ALLIS-BABY.....	537	PINZA PER BIOPSIA, TISCHLER.....	591	PINZA PER MICROCHIRURGIA.....	94
PINZA PER AFFERRARE INTESTINI, ATRAUMA.....	111	PINZA PER BIOPSIA, TISCHLER-KEVORK.....	592	PINZA PER OCCLUSIONE TANGENZIALE, DEBAKEY-SATINSKY .....	502
PINZA PER AFFERRARE INTESTINI, BABCOCK.....	539	PINZA PER BIOPSIA, TISCHLER-MORGAN .....	590, 591	PINZA PER OSSA LAMBERT-LOWMAN.....	249
PINZA PER AFFERRARE INTESTINI, COLLIN.....	539	PINZA PER BIOPSIA, VAN DOREN.....	588	PINZA PER OSSA, FELDHEIM.....	249
PINZA PER AFFERRARE INTESTINI, DUVAL.....	539	PINZA PER BIOPSIA, WITTNER.....	589	PINZA PER OSSA, GERSTER.....	250
PINZA PER AFFERRARE INTESTINI, JUDD-ALLIS.....	538	PINZA PER BIOPSIA, TISCHLER-MORGAN .....	590	PINZA PER OSSA, LOWMAN.....	249
PINZA PER AFFERRARE INTESTINI, LITTLEWOOD.....	538	PINZA PER BRONCHI, FINOCCHIETTO .....	490	PINZA PER OSSA, LOWMAN-HOGLUND.....	249
PINZA PER AFFERRARE INTESTINI, THOMS-ALLIS.....	538	PINZA PER BRONCHI, HARRINGTON.....	490	PINZA PER PATELLA.....	248
PINZA PER AFFERRARE INTESTINI, WILLIAMS.....	539	PINZA PER BRONCHI, LEES.....	504	PINZA PER PEDUNCOLO RENALE, HERRICK.....	123
PINZA PER AFFERRARE L'UTERO, COLLIN.....	585	PINZA PER BRONCHI, PRICE-THOMAS.....	490	PINZA PER PEDUNCOLO RENALE, WERTHEIM-CULLEN .....	125
PINZA PER AFFERRARE L'UTERO, DARTIGUES.....	585	PINZA PER BRONCHI, SEMB.....	491	PINZA PER PILORO, BENSON.....	544
PINZA PER AFFERRARE L'UTERO, SOMER.....	585	PINZA PER BRONCO-ESOFAGOSCOPIA, CHEVALIER-JACK.....	473	PINZA PER POLIPI LARINGEI FRAENKEL.....	471
PINZA PER AFFERRARE TENDINI.....	293	PINZA PER CALAZIO, AYER.....	393	PINZA PER POLIPI LARINGEI JURASZ.....	471
PINZA PER AFFERRARE TENDINI JACKSON.....	292	PINZA PER CALAZIO, DESMARRES.....	393	PINZA PER POLIPI LARINGEI, JACKSON.....	471
PINZA PER AFFERRARE TENDINI KLEINERT-KUTZ.....	294	PINZA PER CALAZIO, LAMBERT.....	393	PINZA PER POLIPI UTERINI, DOYEN.....	585
PINZA PER AFFERRARE TENDINI, BRAND.....	293	PINZA PER CALCOLI BILIARI BLAKE.....	531	PINZA PER POLIPI UTERINI, KELLY.....	585
PINZA PER AFFERRARE TENDINI, CAROLL.....	293	PINZA PER CALCOLI BILIARI DESJARDINS.....	531	PINZA PER POLIPI UTERINI, NOTO.....	585
PINZA PER AFFERRARE TENDINI, LARSEN.....	292	PINZA PER CALCOLI BILIARI MAYO-BLAKE.....	531	PINZA PER POLIPI, HARTMANN.....	424
PINZA PER AFFERRARE TENDINI, STEINMANN.....	292	PINZA PER CALCOLI BILIARI MIXTER.....	531	PINZA PER POLIPI, LITTAUER.....	425
PINZA PER AFFERRARE TESSUTI, BROWN.....	83	PINZA PER CALCOLI RENALI, HEIMING.....	536	PINZA PER POLIPI, NOYES.....	425
PINZA PER AFFERRARE TESSUTI, CHAPUT.....	110	PINZA PER CALCOLI RENALI, RANDALL.....	536	PINZA PER RADDRIZZARE IL SETTO NASALE, ASCH.....	449
PINZA PER AFFERRARE TESSUTI, COLLIN.....	110	PINZA PER CAROTIDE JAVID.....	511	PINZA PER RADDRIZZARE IL SETTO NASALE, WALSHAM .....	449
PINZA PER AFFERRARE TESSUTI, SINGLEY.....	88	PINZA PER CATETERI COOLEY.....	510	PINZA PER RIFIUTI SAUERBRUCH.....	227
PINZA PER AFFERRARE TESSUTI, TUFFIER.....	110	PINZA PER COARTAZIONE E ANASTOMOSI POTTS.....	492, 493	PINZA PER RIPOSIZIONE, ROWE.....	459
PINZA PER AGRAFES, CHILDE.....	224	PINZA PER CORPI ESTRANEI STRUEMPEL.....	412	PINZA PER ROVESCiare PALPEBRE, SNELLEN.....	393
PINZA PER AGRAFES, COLLIN.....	224	PINZA PER CORPI ESTRANEI, MATHIEU.....	553/1	PINZA PER SCHEGGE.....	91
PINZA PER AGRAFES, HEGENBARTH.....	224	PINZA PER CRANIOTOMIA CONE.....	331	PINZA PER SCHEGGE, ARCHER.....	92
PINZA PER AGRAFES, MICHEL.....	224	PINZA PER EMORROIDI, HEYWOOD-SMITH.....	567	PINZA PER SCHEGGE, CARMALT.....	91
PINZA PER AGRAFES, WACHENFELDT.....	224	PINZA PER FILO, MCPHERSON.....	392	PINZA PER SCHEGGE, FELCHENFELD.....	91
		PINZA PER FILO, MOD. TUEBINGEN.....	392	PINZA PER SCHEGGE, HUNTER.....	91
		PINZA PER FILO, PAUFIQUE.....	392	PINZA PER SCHEGGE, PEET.....	92
		PINZA PER GOZZO, LAHEY.....	479	PINZA PER SCHEGGE, VIRTUS (RALK).....	92
		PINZA PER IL CUIOIO CAPELLUTO, GAUSS.....	605	PINZA PER SCHEGGE, STIEGLITZ.....	92
		PINZA PER INTRODUZIONE SONDE MAGILL.....	28	PINZA PER SETTO NASALE, BRUENINGS.....	425
		PINZA PER IPOFISI.....	341	PINZA PER SETTO NASALE, HEYMANN.....	425
		PINZA PER IPOFISI, ADSON.....	334	PINZA PER SETTO NASALE, LUC.....	426
		PINZA PER IRIDE BARRAQUER (COLIBRI).....	384	PINZA PER SETTO NASALE, MIDDLETON-JANSEN.....	430
		PINZA PER IRIDE, BARRAQUER-KATZIN.....	384	PINZA PER SETTO NASALE, RUBIN.....	428
		PINZA PER IRIDE, BISHOP-HARMAN.....	386	PINZA PER SINUSCOPIA.....	431
		PINZA PER IRIDE, BONN.....	387	PINZA PER STERILIZZAZIONE.....	227
		PINZA PER IRIDE, FISCHER.....	384	PINZA PER STERILIZZAZIONE DAVIS.....	227
		PINZA PER IRIDE, FOERSTER.....	383	PINZA PER STERILIZZAZIONE, CHEATLE.....	227
		PINZA PER IRIDE, GILL.....	384	PINZA PER STERILIZZAZIONE, ROGGE.....	227
		PINZA PER IRIDE, GILL-HESS.....	384		

PINZA PER STERILIZZAZIONE, UNIVERSAL.....	227	PINZA TAGLIENTE PER DISCHI INTERVERTEBRALI, FERRIS-SMITH-KERRISON.....	344, 344/2	PORT'AGHI, DE BAKEY.....	210
PINZA PER STRABISMO, BONACCOLTO.....	385	PINZA TAGLIENTE PER LAMINECTOMIA, CLOWARD.....	342	PORT'AGHI, DERF.....	208
PINZA PER STRABISMO, DASTOOR.....	386	PINZA TAGLIENTE PER LAMINECTOMIA, OLDBERG.....	341	PORT'AGHI, FINOCCHIETTO.....	211
PINZA PER STRABISMO, JAMESON.....	385	PINZA TAGLIENTE PER LAMINECTOMIA, SCHLESINGER.....	342	PORT'AGHI, GILLIES.....	212
PINZA PER STRABISMO, MCCULLOUGH.....	385	PINZA TAGLIENTE PER LAMINECTOMIA, SPURLING.....	340	PORT'AGHI, HALSEY.....	208
PINZA PER SUTURA, CASTROVIEJO.....	392	PINZA TAGLIENTE PER LAMINECTOMIA, WAGNER.....	343	PORT'AGHI, HALSEY.....	208
PINZA PER SUTURA, MOORFIELD.....	392	PINZA TAGLIENTE PER LAMINECTOMIA, CUSHING.....	340	PORT'AGHI, HEANEY.....	210
PINZA PER SUTURA, ST. MARTIN.....	392	PINZA TAGLIENTE PER LAMINECTOMIA, FERRIS-SMITH.....	343	PORT'AGHI, HOESEL.....	213
PINZA PER TAMPONI, BOZEMANN.....	138	PINZA TAGLIENTE PER LAMINECTOMIA, LOVE-GRUENWALD.....	340	PORT'AGHI, JOHNSON.....	215
PINZA PER TAMPONI, BOZEMANN-DOUGLAS.....	138	PINZA TAGLIENTE PER SETTO NASALE, CITELLI.....	430	PORT'AGHI, JOHNSON.....	211
PINZA PER TONSILLE COLVER.....	467	PINZA TIRALINGUA, COLLIN.....	453	PORT'AGHI, KALT-ARRUGA.....	214
PINZA PER TONSILLE, BALLENGER.....	467	PINZA TIRALINGUA, YOUNG.....	453	PORT'AGHI, KILNER.....	212
PINZA PER TONSILLE, BLOHMKE.....	467	PINZA TORCIFILI, BERRY TC.....	319	PORT'AGHI, LANGENBECK.....	213
PINZA PER TONSILLE, MARSCHIK.....	468	PINZA TORCIFILI, CORWIN-HEGAR TC.....	319	PORT'AGHI, LICHTENBERG.....	213
PINZA PER TONSILLE, NEGUS.....	467	PINZA TORCIFILI, MAYO-HABERISSER TC.....	319	PORT'AGHI, MASSON.....	210
PINZA PER TONSILLE, SAWTELL.....	467	PINZA ULTRA LIGHT.....	95	PORT'AGHI, MATHIEU.....	213
PINZA PER TONSILLE, SCHNIDT.....	467	PINZA UTERINA PER EMOSTASI, GREEN-ARMYTAGE.....	605	PORT'AGHI, MATHIEU-OLSEN.....	212
PINZA PER TONSILLE, TYDING.....	467, 468	PINZA VASCOLARE BAINBRIDGE.....	495	PORT'AGHI, MAYO-HEGAR.....	209
PINZA PER TONSILLE, WHITE.....	467	PINZA VASCOLARE GLOVER.....	515	PORT'AGHI, METZENBAUM.....	211
PINZA PER TRACOMA, KNAPP-LUER.....	393	PINZA VASCOLARE, ADLERKREUTZ.....	84	PORT'AGHI, NEIVERT.....	208
PINZA PER TRAZIONE CRANIALE, CRUTCHFIELD.....	327	PINZA VASCOLARE, DIEFFENBACH.....	104	PORT'AGHI, OLSEN-HEGAR.....	212
PINZA PER TUMORI, YASARGIL.....	97	PINZA VASCOLARE, LELAND-JONES.....	494	PORT'AGHI, RYDER.....	210
PINZA PERITONEALE, FAURE.....	123	PINZA VASCOLARE, SATINSKY.....	491	PORT'AGHI, SAROT.....	211
PINZA PERITONEALE, MIKULICZ, 20CM.....	123	PINZA VASCOLARE, STILLE-BARRAYA.....	88	PORT'AGHI, STEVENS.....	214
PINZA PERITONEALE, MIKULICZ-BABY.....	123	PINZA, DAVIS.....	227	PORT'AGHI, WANGENSTEEN.....	210
PINZA PERITONEALE, PHANEUF.....	123	PINZE ATRAUMATICHE BULLDOG DE BAKEY.....	103	PORT'AGHI, WEBSTER.....	208
PINZA PORTAPLACCHE, LANE.....	325	PINZE ATRAUMATICHE BULLDOG GLOVER.....	103	PORT'AGHI, BABY-OLSEN-HEG.....	212
PINZA PORTAVITI, LANE.....	325	PINZE ATRAUMATICHE BULLDOG IN TITANIO.....	102	PORT'AGHI, STRATTE.....	212
PINZA POSA CLIPS BIEMER.....	361,363,364,366	PINZE ATRAUMATICHE, DE BAKEY.....	98	PORTATORE DI LUCE FREDDA A FIBRE DI VETRO KLEINSASSER.....	36
PINZA POSA CLIPS, MEHDORN.....	362	PINZE PER SCHEGGE.....	90	POSA CLIPS.....	357,358, 359, 360
PINZA POSA CLIPS, RANEY.....	327	PIPER FORCIPE.....	604	POSA CLIPS JOHNS-HOPKINS.....	104
PINZA RENALE GUYON.....	122	PISTOLA LAVATRICE.....	626	POSA CLIPS, MC KENZIE.....	326
PINZA SERRAPENE, STOCKMANN.....	553/1	PISTONI.....	258, 259	POSA CLIPS, SMITHWICK.....	326
PINZA SERRAPENE, STRAUSS.....	553/1	PISTONI CASPAR.....	258	POSA CLIPS, SWEET.....	326
PINZA SERRATUBI.....	129	PLACCA PER PALPEBRE JAEGER.....	371	POST MORTEM AGO.....	268
PINZA SERRATUBI, HOFFMANN.....	624	PLACCA PER STENDIPELLE.....	49	POTTS PINZA PER COARTAZIONE E ANASTOMOSI .....	492, 493
PINZA SERRATUBI, SIMPLEX.....	624	PLESTER CANNULA D'ASPIRAZIONE.....	338	POTTS SMITH PINZA CHIRURGICA.....	81
PINZA SERRATUBI, BÜLOW-GUNAR-HEY.....	130	PLESTER COLTELLO.....	418	POTTS-DE MARTEL FORBICI VASCOLARI.....	59
PINZA SFENOIDALE HAJEK-KOFLER.....	430, 431	PLESTER DIVARICATORE.....	171	POTTS-SMITH FORBICI VASCOLARI.....	61
PINZA SGORBIA BANE-HARTMANN.....	237	POLITZER AGO PER PARACENTESI.....	408	POTTS-SMITH PINZA ANATOMICA.....	81
PINZA SGORBIA MAYFIELD.....	238	POLITZER COLTELLO AURICOLARE.....	408	PRATT DILATATORE UTERINO.....	580
PINZA SGORBIA SMITH-PETERSEN.....	238	POLITZER INSOFFIATORE D'ARIA.....	406	PRATT PINZA DA PRESA.....	110
PINZA SGORBIA, ADSON.....	236	POLITZER OLIVA NASALE.....	406	PRATT PINZA PER ABBASSARE IL COLLO DELL'UTERO.....	584
PINZA SGORBIA, BLUMENTHAL.....	236	POLITZER SPECOLO AURICOLARE.....	399	PRATT SPECILLO PER FISTOLE.....	563
PINZA SGORBIA, BOEHLER.....	238	POMPA D'ARIA.....	295	PRATT SPECILO RETTALE.....	559
PINZA SGORBIA, CLEVELAND.....	235	POOLE CANNULA D'ASPIRAZIONE.....	27	PRECISA SFIGMOMANOMETRO.....	9
PINZA SGORBIA, ECHLIN.....	240	PORTA AGRAFES.....	326	PRICE-THOMAS PINZA PER BRONCHI.....	490
PINZA SGORBIA, FRIEDMAN-MICRO.....	234	PORTACOTONE, FARRELL.....	203	PRINCE FORBICI PER TONSILLE.....	59
PINZA SGORBIA, FRIEDMAN-MINI.....	234	PORTACOTONE, JOBSON-HORNE.....	203	PRINCE PINZA MUSCOLARE.....	387
PINZA SGORBIA, FRYKHOLM.....	240	PORTACOTONE, REDA.....	203	PROTEGGIDITA, LANGENBECK.....	311
PINZA SGORBIA, JANSEN.....	237	PORTACOTONE, TOBOLD.....	203	PROCTOSCOPO BENSAUDE.....	565
PINZA SGORBIA, KLEINERT-KUTZ.....	237	PORTACOTONE, UCKERMANN.....	203	PROCTOSCOPO MORGAN.....	565
PINZA SGORBIA, LEMPERS.....	237	PORT'AGHI BARRAQUER.....	216, 217	PROCTOSCOPO, CHELSEA-EATON.....	563
PINZA SGORBIA, LUER.....	236	PORT'AGHI CASTROVIEJO.....	216	PROCTOSCOPO, FANSLER.....	565
PINZA SGORBIA, MARQUARDT.....	239	PORT'AGHI MICROVASCOLARE.....	210	PROCTOSCOPO, KELLY.....	563
PINZA SGORBIA, MEAD.....	235	PORT'AGHI, ADSON.....	211	PROVIDENCE-HOSPITAL PINZA EMOSTATICA.....	106
PINZA SGORBIA, OLIVECRONA.....	237	PORT'AGHI, ARRUGA.....	214	PUNTE PER SPECILLI.....	201
PINZA SGORBIA, RUSKIN.....	239	PORT'AGHI, BABY-WEBSTER.....	208	PUTTI RASPA PER OSSA.....	294
PINZA SGORBIA, SAUERBRUCH.....	240	PORT'AGHI, BARRAQUER-TROUTMAN.....	216	Q QUERVAIN ELEVATORE.....	275
PINZA SGORBIA, SCAGLIETTI.....	240	PORT'AGHI, BAUMGARTNER.....	208	QUINBY FORBICI GINGIVALI.....	67
PINZA SGORBIA, SEMB.....	240	PORT'AGHI, BOYNTON.....	214	QUIRE LEVA PER CORPI ESTRANEI.....	412
PINZA SGORBIA, STELLBRINK.....	234	PORT'AGHI, BOZEMANN.....	211	QUISLING MARTELLO.....	271
PINZA SGORBIA, ZAUFBAL-JANSEN.....	238	PORT'AGHI, BROWN.....	209		
PINZA SGORBIA, LEKSELL-STILLE.....	240	PORT'AGHI, CASTROVIEJO.....	215		
PINZA SGORBIA, STILLE-LUER.....	239	PORT'AGHI, CASTROVIEJO MICRO.....	215		
PINZA SGORBIA, STILLE-RUSKIN.....	239	PORT'AGHI, COLLIER, 12,5CM.....	208		
PINZA STOMACALE LANE.....	547	PORT'AGHI, CRILE.....	213		
PINZA STRAPPAGESSI, WOLFF.....	233	PORT'AGHI, CRILE-MURRAY.....	209		
PINZA TAGLIENTE CIRCOLARE.....	432	PORT'AGHI, CRILE-WOOD TC.....	209		
PINZA TAGLIENTE NASALE, KERRISON.....	428				
PINZA TAGLIENTE PER CAPSULA, HOLTH.....	380				
PINZA TAGLIENTE PER DISCHI INTERVERTEBRALI, COLCLOUGH.....	344/1				

R			
RACCORDO DI LAVAGGIO.....	626	ROBB SPATOLA.....	530
RACHITOMO.....	267	ROBERTS PINZA EMOSTATICA.....	117
RADOLF PINZA PER LACERAZIONE UNGHIE.....	297	ROCHARD DIVARICATORE ADDOMINALE.....	186
RAGNELL DIVARICATORE.....	140	ROCHARD SUPPORTO.....	186
RALK PERFORATORE A MANO.....	300	ROCHESTER-CARMALT.....	109
RAMPLEY PINZA PER MEDICATURA.....	136	ROCHESTER-OCHSNER PINZA EMOSTATICA.....	108
RAMUS DIVARICATORE.....	461	ROCHESTER-PEAN PINZA EMOSTATICA.....	108
RANDALL CURETTA PER BIOPSIA.....	587	ROEDER PINZA FISSATELI.....	132
RANDALL PINZA PER CALCOLI RENALI.....	535	ROGER ELEVATORE PER SETTO.....	437, 438
RANEY GRAFFA PER IL CUIOIO CAPELLUTO.....	327	ROGERS PINZA PER ISTERECTOMIA.....	127
RANEY PINZA POSA CLIPS.....	327	ROGGE PINZA PER STERILIZZAZIONE.....	227
RASCHIATOIO CORNEALE, KUHNIT.....	373	ROLLET SCALPELLO ESTIRPATORE.....	374
RASOIO.....	49	ROLLET UNCINO DIVARICATORE.....	375
RASPA NASALE FOMON TC.....	445	ROMPILAMETTE, CASTROVIEJO.....	45
RASPA NASALE GALLAHER.....	446	ROMPILAMETTE, REDA.....	45
RASPA NASALE MILLER.....	444	ROMPILAMETTE, TROUTMAN-CHRIS.....	45
RASPA NASALE PEET.....	446	ROSE DIVARICATORE.....	140
RASPA NASALE, FOMON.....	444	ROSEN AGO.....	419
RASPA NASALE, JOSEPH.....	443	ROSEN CANNULA D'ASPIRAZIONE.....	338
RASPA NASALE, JOSEPH (LEWIS).....	443	ROSEN COLTELLO.....	418
RASPA NASALE, MALTZ.....	443	ROSER-KOENIG APRIBOCCA.....	454
RASPA NASALE, MALTZ (COTTLE).....	444	ROTATORE PER NUCLEO BECHERT.....	379
RASPA NASALE, WIENER.....	443	ROUX MINI DIVARICATORE.....	140
RASPA PER OSSA.....	294	ROUX DIVARICATORE.....	139
RASPA PER OSSA PUTTI.....	294	ROUX-BABY DIVARICATORE.....	140
RECAMIER CURETTE UTERINI.....	597	ROWE PINZA PER RIPOSIZIONE.....	459
RECIPIENTE CILINDRICO.....	620	RUBIN OSTEOTOMO PER SETTO.....	440
REDA DIAPASON.....	403	RUBIN PINZA PER SETTO NASALE.....	428
REDA CALAMITA OCULISTICA.....	395	RUDD LEGATORE EMORROIDALE.....	568
REDA COLTELLO FALCATO.....	435	RUMEL PINZA EMOSTATICA.....	117
REDA COLTELLO PER AMPUTAZIONE.....	44	RUMEL-BELMONT TOURNIQUET.....	528
REDA CURETTA TAGLIANTE.....	256	RUSKIN PINZA SGORBIA.....	239
REDA DIVARICATORE PER GESSI.....	232	RUSKIN-LISTON CESOIA PER OSSA.....	241
REDA EXCENTER FORBICI PER BENDAGGI.....	69/2	RUSSEL-DAVIS ABBASSALINGUA.....	458
REDA PERFORATORE A MANO.....	300	RYDEL-SEIFFERT DIAPASON.....	404
REDA PINZA COPERCHIO.....	615	RYDER PORT AGHI.....	210
REDA PINZA DEPIPARATORIA.....	395		
REDA PINZA PER AFFERRARE INTESTINI.....	111	S	
REDA PORTACOTONE.....	203	SAALFELD SCHIACCIACOMEDONI.....	608
REDA ROMPILAMETTE.....	45	SACHS DURA DISSETTORE.....	332
REDA SEGA TAGLIA ANELLI.....	297	SACHS UNCINO PER NERVI.....	329
REDA SONDA CONDOTTRICE A FORCHETTA.....	221	SAENGER PINZA PER ABORTO.....	606
REDA SPECOLO NASALE.....	423	SALPINGOGRAFO.SCHULTZE.....	596
REDA UNCINO PER LA PELLE.....	150	SANVENERO FORBICI PER CHIRURGIA.....	54
REDON AGO DI GUIDA.....	207	SAROT PINZA EMOSTATICA.....	118
REES FACE LIFT FORBICI.....	73	SAROT PORT AGHI.....	211
REGOLO DI METALLO.....	25	SATINSKY FORBICI VASCOLARI.....	65/2
REICHERT DEPRESSORE PER EPIGLOTTIDE.....	471	SATINSKY PINZA VASCOLARE.....	491
REILL TENAGLIA PER OSSA.....	248	SATO DISSETTORE CORNEALE.....	373
REINER COLTELLO PER GESSI.....	233	SATTERLEE SEGA PER AMPUTAZIONE.....	296
REINER SIRINGA AURICOLARE.....	406	SAUERBRUCH COSTOTOMO.....	481
RESANO PINZA INTESTINALE.....	542	SAUERBRUCH DIVARICATORE.....	164
RESANO, FORBICI PER CAPSULA.....	53/2	SAUERBRUCH DIVARICATORE.....	166
RETRATTORE, PERCY.....	296	SAUERBRUCH PINZA PER RIFIUTI.....	227
RETRATTORI INTRAORALI.....	463/1	SAUERBRUCH PINZA SGORBIA.....	240
RETRATTORI INTRAORALI.....	463/4	SAUERBRUCH-FREY COSTOTOMO.....	481
REVERDIN AGO.....	220	SAWTELL PINZA PER TONSILLE.....	467
REVERDIN SPATOLA ADDOMINALE E INTESTINALE.....	143/1	SAWYER SPECOLO RETTALE.....	560
REYNOLDS FORBICI PER CHIRURGIA.....	54	SAYRE ELEVATORE.....	281
REYNOLDS SUPERSCUT FORBICI.....	72	SCAGLIETTI PINZA SGORBIA.....	240
RIBBON SPATOLA ADDOMINALE E INTESTINALE.....	143	SCALP-CONTOUR DIVARICATORE.....	169
RICARD DIVARICATORE ADDOMINALE.....	191	SCALPELLI.....	259
RICHARDSON DIVARICATORE.....	142	SCALPELLO ESTIRPATORE, ROLLET.....	374
RICHARDSON-EASTMAN DIVARICATORE.....	142	SCALPELLO PARTSCH.....	259
RICHARDSON-GRIP DIVARICATORE.....	142	SCALPELLO PER SETTO, CINELLI.....	441
RICHNAU-HOLMGREN SPECOLO AURICOLARE.....	400	SCALPELLO PER SETTO, COTTLE.....	440
RICHTER-HEATH PINZA PER AGRAFES.....	224	SCALPELLO PER SETTO, FREER.....	439
RIENHOFF-FINOCHIETTO DIVARICATORE COSTALE.....	486	SCALPELLO PER SETTO, SILVER.....	442
RIGBY DIVARICATORE ADDOMINALE.....	189/2	SCALPELLO, ALEXANDER.....	259
RI-MINI COMBINAZIONE PER DIAGNOSTICA		SCALPELLO, BRUNETTI.....	268
CON ILLUMINAZIONE ALOGENA.....	17	SCALPELLO, HIBBS.....	265
RITTER-HALLE DILATATORE PER SENO FRONTALE.....	433	SCALPELLO, STILLE.....	260
		SCATOLA PER STERILIZZARE AGHI.....	615
		SCATOLA PER STRUMENTI.....	616, 617, 618
		SCHAEDEL PINZA FISSATELI.....	132
		SCHAMBERG SCHIACCIACOMEDONI.....	608
		SCHAEDE CURETTA TAGLIANTE.....	251
		SCHIEE COLTELLO PER GONIOATOMIA.....	373
		SCHNEIMANN INSERTO.....	472
		SCHERBAK SPECOLO VAGINALE.....	575
		SCHIACCIACOMEDONI, SAALFELD.....	608
		SCHIACCIACOMEDONI, SCHAMBERG.....	608
		SCHIACCIACOMEDONI, UNNA.....	608
		SCHIACCIACOMEDONI, WALTON.....	608
		SCHIACCIATORE PER L'INTESTINO E LO STOMACO, PAYR.....	548
		SCHIMMELBUSCH TAMBURO.....	622
		SCHINK DERMATOMO.....	49
		SCHIOETZ TONOMETRO.....	394/2
		SCHLESINGER PINZA TAGLIANTE PER LAMINECTOMIA.....	342
		SCHMEDEN PINZA NASALE.....	427
		SCHMID CANNULA PER IRRIGAZIONE.....	338
		SCHMIEDEN SPECILLO DI GUIDA SCANALATO.....	221
		SCHMIEDEN-DICK AGO PER LEGATURE.....	219
		SCHMIEDEN-TAYLOR FORBICI PER DURAMADRE.....	65/1
		SCHNIDT PINZA PER TONSILLE.....	467
		SCHOENBORN DIVARICATORE PER TIROIDE.....	479
		SCHRÖDER CUCCHIAIO UTERINO.....	595
		SCHROEDER(POZZI) PINZA PER ABBASSARE IL COLLO DELL'UTERO.....	582
		SCHUBERT PINZA PER BIOPSIA.....	588
		SCHUKNECHT COLTELLO.....	418
		SCHULTZE SALPINGOGRAFO.....	596
		SCHULZE-BERGSMANN SPECOLO RETTALE.....	560
		SCHUMACHER FORBICI PER STERNO.....	481
		SCHUMACHER INSERTO.....	472
		SCHUMACHER PINZA PER BIOPSIA.....	588, 589
		SCHWIGGER PINZA CAPSULARE.....	391
		SCLEROTOMO, GUYTON-LUNDSGAARD.....	373
		SCLEROTOMO, LUNDBGAARD.....	373
		SCOVILLE CURETTA TAGLIANTE.....	253
		SCOVILLE DIVARICATORE PER LAMINECTOMIA.....	196
		SCOVILLE UNCINI PER RADICI DEI NERVI.....	330
		SCOVILLE VALVE.....	196
		SCOVILLE-HAVERFIELD DIVARICATORE PER LAMINECTOMIA.....	196
		SCUDDER PINZA INTESTINALE.....	541
		SEBILAU ELEVATORE.....	275
		SEDLITT PERIOTOTOMO.....	274, 275
		SEGA , GIGLI.....	332
		SEGA ELETTRICA PER GESSI.....	230
		SEGA IN FILO D'ACCIAIO, OLIVECRONA.....	332
		SEGA NASALE , JOSEPH.....	446
		SEGA OSCILLANTE PER GESSI CON ASPIRAZIONE.....	231
		SEGA PER AMPUTAZIONE BIER.....	296
		SEGA PER AMPUTAZIONE, CHARRIERE.....	296
		SEGA PER AMPUTAZIONE, SATTERLEE.....	296
		SEGA PER AUTOPSIA.....	231/1
		SEGA PER DITA, LANGENBECK.....	296
		SEGA PER GESSI, ENGEL.....	229
		SEGA TAGLIA ANELLI, REDA.....	297
		SEGA TAGLIA ANELLI, WALTON.....	297
		SEGOND BISTURI PER FIBROMI.....	594
		SEGOND PINZA PER ISTERECTOMIA.....	125
		SEGOND-LANDAU PINZA PER ISTERECTOMIA.....	125
		SEIFERT INSERTO.....	472
		SELDIN PERIOTOTOMO.....	277
		SELLHEIM CUCCHIAIO OSTETRICO.....	607
		SEMB CESOIA PER OSSA.....	242
		SEMB PERIOTOTOMO.....	278
		SEMB PINZA PER BRONCHI.....	491
		SEMB PINZA SGORBIA.....	240
		SEMB TENAGLIA PER OSSA.....	243
		SEMKEN PINZA ANATOMICA.....	86

SEMKEN PINZA CHIRURGICA.....	86	SINGLEY PINZA PER AFFERRARE TESSUTI.....	88	SPECILLO DI GUIDA SCANALATO, SCHMIEDEN.....	221
SEMM SPECILO VAGINALE.....	571	SINSKEY UNCINO.....	376	SPECILLO DI GUIDA, VIENNA.....	221
SENN-GREEN DIVARICATORE.....	153	SINUS ELEVATORE PER SETTO.....	438	SPECILLO FOGLIA MIRTE.....	199
SENN-MILLER DIVARICATORE.....	143	SIRINGA AURICOLARE.....	407	SPECILLO PER CANALE LACRIMALE BOWMAN.....	381
SEPERATORE PER IL CORPO MANDIBOLARE HARGIS.....	463/6	SIRINGA AURICOLARE, REINER.....	406	SPECILLO PER FISTOLE LOCKHART-MUMMERY.....	200
SEPERATORI SAGITTALI SMITH.....	463/5	SIRINGA PER TONSILLE.....	470	SPECILLO PER FISTOLE, PRATT.....	563
SEPTEMZANGE KNIGHT.....	425	SISTEMA DI FISSAGGIO, LEYLA.....	368, 368/1, 368/2, 368/3, 368/4	SPECILLO SCANALATO.....	199
SERPENTINE PINZA PER BIOPSIA.....	593	SISTEMA RETRATTORE.....	188	SPECILLO SCANALATO, BRODIE.....	199
SERRANODI KRAUSE.....	433/2	SKENE PINZA PER ABBASSARE IL COLLO.....		SPECILLO SCANALATO, DOYEN.....	199
SERRANODI KRAUSE-VOSS.....	433/2	DELL'UTERO.....	582	SPECILLO SCANALATO, NELATON.....	199
SERRANODI PER TONSILLE, BRUENINGS.....	468	SLS PINZA APPLICATORE CLIPS MICRO.....	524, 525	SPECILLO, FISH.....	199
SERRANODI PER TONSILLE, EVES.....	468	SLUDER-BALLENGER TONSILLOTOMO.....	470	SPECILLO, WATSON-CHEYNE.....	199
SERRANODI RETTALE, WESTON.....	566	SMELLIE PERFORATORE.....	607	SPECILO AURICOLARE RICHNAU-HOLMGREN.....	400
SERRANODI WILDE.....	433/2	SMELLIE UNCINO.....	605	SPECILO AURICOLARE, BOUCHERON.....	399
SET LARINGOSCOPIO FOREGGER.....	31	SMELLIE COLTELLO PER MENISCO.....	292	SPECILO AURICOLARE, BRUENINGS.....	401
SET LARINGOSCOPIO MC INTOSH.....	31	SMILLIE ELEVATORE PER OSSA.....	291	SPECILO AURICOLARE, GRUBER.....	399
SET PER INFERMERIA.....	609	SMITH BLEFAROSTATO.....	370	SPECILO AURICOLARE, HARTMANN.....	399
SET PER SUTURA IN ASTUCCIO DI METALLO.....	225, 226	SMITH SEPARATORI SAGITTALI.....	463/5	SPECILO AURICOLARE, POLITZER.....	399
SET PER TRACHEOTOMIA.....	478	SMITH US ARMY FORBICI PER BENDAGGI.....	69/1	SPECILO AURICOLARE, SIEGLE.....	402
SET PER VARICI IN SCATOLA DI METALLO, NABATOFF.....	201	SMITH-BUIE DIVARICATORE ANALE.....	561	SPECILO AURICOLARE, TOYNBEE.....	399
SEUTIN FORBICI PER BENDAGGI.....	69/2	SMITH-PETERSEN OSTEOTOMO.....	261	SPECILO LATERALE.....	569
SEXTON COLTELLO AURICOLARE.....	408	SMITH-PETERSEN PINZA SGORBIA.....	238	SPECILO NASALE HARTMANN.....	422
SFIGMOMANOMETRO, BABYPHON.....	10	SMITHWICK PINZA POSA CLIPS.....	326	SPECILO NASALE REDA.....	423
SFIGMOMANOMETRO, DIPLOMAT.....	5	SMITHWICK UNCINO PER NERVI.....	329	SPECILO NASALE, COTTLE.....	423
SFIGMOMANOMETRO, EXACTA.....	8	SNELLEN ANSA PER CATERATA.....	378	SPECILO NASALE, HARTMANN-HALLE.....	421
SFIGMOMANOMETRO, MINIMUS II.....	11	SNELLEN PINZA PER ROVESCIARE PALPEBRE.....	393	SPECILO NASALE, KILLIAN.....	423
SFIGMOMANOMETRO, MINIMUS III.....	12	SOMER PINZA PER AFFERRARE L'UTERO.....	585	SPECILO NASALE, MOD.VIENNA.....	421
SFIGMOMANOMETRO, NOVA.....	6,7	SONDA BOTTUNUTA, JACOBSON.....	335	SPECILO NASALE, THUDICHUM.....	421
SFIGMOMANOMETRO, PRECISA.....	9	SONDA CONDUITTRICE A FORCHETTA.....	475	SPECILO NASALE, TIECK-HALLE.....	423
SGORBIA.....	264	SONDA CONDUITTRICE A FORCHETTA REDA.....	221	SPECILO NASALE, VOLTOLINI.....	421
SGORBIA, PARTSCH.....	259	SONDA PER CALCOLI BILIARI DESJARDINS.....	532	SPECILO RETTALE HILL-FERGUSON.....	560
SGORBIA ALEXANDER.....	259	SONDA PER CALCOLI BILIARI MOYNIHAN.....	532	SPECILO RETTALE SAWYER.....	560
SGORBIA BRÜNINGS-LUCAS.....	260	SONDA PER CALCOLI BILIARI, MAYO.....	534	SPECILO RETTALE, ALAN-PARKS.....	561
SGORBIA KILLIAN.....	442/1	SONDA PER GOZZO, KOCHER.....	479	SPECILO RETTALE, BARR.....	559
SGORBIA PER CORPI ESTRANEI, DIX.....	374	SONDA, WORST.....	381	SPECILO RETTALE, BODENHAMMER.....	559
SGORBIA PER CORPI ESTRANEI, ELLIS.....	374	SONDA, WORST.....	381	SPECILO RETTALE, CZERNY.....	559
SGORBIA PER CORPI ESTRANEI, WALTON.....	374	SPATOLA ADDOMINALE.....	144	SPECILO RETTALE, MATHIEU.....	560
SGORBIA PER SETTO FREER.....	442/1	SPATOLA ADDOMINALE E INTESTINALE LERICHE.....	143/2	SPECILO RETTALE, PRATT.....	559
SGORBIA PER SETTO, HAJEK.....	442/1	SPATOLA ADDOMINALE E INTESTINALE, HABERER.....	143/1	SPECILO RETTALE, SIMS.....	559
SGORBIA PER SETTO, KILLIAN-CLAUS.....	442/1	SPATOLA ADDOMINALE E INTESTINALE, REVERDIN.....	143/1	SPECILO RETTALE, SCHULZE-BERG.....	560
SGORBIA WEST.....	442/1	SPATOLA ADDOMINALE E INTESTINALE, RIBBON.....	143	SPECILO VAGINALE, JACKSON.....	573
SGORBIA, COBB.....	262	SPATOLA ADDOMINALE ED INTESTINALE KADER.....	143/1	SPECILO VAGINALE, AUWARD.....	576
SGORBIA, HIBBS.....	265	SPATOLA ADDOMINALE ED INTESTINALE KÖRTE.....	143/1	SPECILO VAGINALE, BREISKY.....	577
SGORBIA, LEXER MINI.....	263	SPATOLA ADDOMINALE ED INTESTINALE KÜMMEL.....	143/2	SPECILO VAGINALE, COLLIN.....	570
SGORBIA, ZIELKE.....	264	SPATOLA CEREBRALE CUSHING.....	369	SPECILO VAGINALE, CUSCO.....	570, 571
SGORBIA, STILLE.....	260	SPATOLA CEREBRALE DAVIS.....	337	SPECILO VAGINALE, DOYEN.....	574
SGORBIE.....	259	SPATOLA CEREBRALE HEIFETZ.....	369	SPECILO VAGINALE, FRIEDMANN.....	577
SHAMBAUGH UNCINO.....	419	SPATOLA CEREBRALE, CUSHING.....	336	SPECILO VAGINALE, GRAVE.....	570
SHAPLEIGH ANSA AURICOLARE.....	410	SPATOLA CEREBRALE, OLIVECRONA.....	336	SPECILO VAGINALE, KALLMORGEN.....	573
SHEA MICRO FORBICI AURICOLARI.....	413	SPATOLA PER CICLODIALISI HIRSCHMAN.....	379	SPECILO VAGINALE, KRISTELLER.....	572
SHEEHAN OSTEOTOMO PER SETTO.....	441	SPATOLA PER CICLODIALISI, BANGENTER.....	379	SPECILO VAGINALE, LANDAU.....	577
SHEETS CANNULA PER IRRIGAZIONE.....	394/2	SPATOLA PER CICLODIALISI, ELSCHNIG.....	379	SPECILO VAGINALE, O'SULLIVAN-O'CONNOR.....	576
SIEBENMANN CANNULA PER IRRIGAZIONE.....	433	SPATOLA PER CICLODIALISI, WHEELER.....	379	SPECILO VAGINALE, PEDERSON.....	570
SIEBOLD FORBICI GINECOLOGICHE.....	62	SPATOLA PER CICLODIALISI, CASTROVIEJO.....	379	SPECILO VAGINALE, SEMM.....	571
SIEGLE SPECILO AURICOLARE.....	402	SPATOLA PER IRIDE, CULLER.....	378	SPECILO VAGINALE, SIMS.....	573
SILVER DERMATOMO.....	50	SPATOLA PER IRIDE, CULLER.....	378	SPECILO VAGINALE, TRELAT.....	571
SILVER SCALPELLO PER SETTO.....	442	SPATOLA PER IRIDE, WECKER.....	378	SPECILO VAGINALE, VU-MORE.....	569
SIMCOE CANNULA PER IRRIGAZIONE.....	394	SPATOLA PER PEDICURE.....	612	SPECILO VAGINALE, SCHERBAK.....	575
SIMON CUCCHIAIO UTERINO.....	594	SPATOLA PER POLMONE, ALLISON.....	489	SPENCER FORBICI PER LEGATURE.....	66
SIMON DIVARICATORE.....	164	SPATOLA ROBB.....	530	SPENCER-WELLS PINZA EMOSTATICA.....	109
SIMPLEX PINZA SERRATUBI.....	624	SPATOLA VESCICALE, KOCHER.....	552	SPIZZATORE UNGHIE.....	612/1
SIMPSON FORCIPE.....	602	SPATOLA VESCICALE, LEGUEU.....	552	SPILLONE PER STERILIZZAZIONE, BUNT.....	227
SIMPSON-BRAUN FORCIPE.....	602	SPAZZOLA PER UNGHIE.....	611	SPILLONE PER STERILIZZAZIONE, MAYO.....	227
SIMPSON-LUIKART FORCIPE.....	603	SPECCHIO FRONTALE ZIEGLER.....	21	SPINAL CURETTA TAGLIANTE.....	253
SIMS CURETTE UTERINI.....	597, 598	SPECCHIO LARINGEO.....	473	SPINA-NASALIS DIVARICATORE.....	461
SIMS DEPRESSORE UTERINO.....	586	SPECCHIO LARINGEO, MICHEL.....	423	SPRATT CURETTA TAGLIANTE.....	251
SIMS DILATATORE UTERINO.....	581	SPECILLO AURICALE, STACKE.....	199	SPRATT CURETTA TAGLIANTE PER LAMINECTOMIA.....	340
SIMS FORBICI GINECOLOGICHE.....	62	SPECILLO DI GUIDA SCANALATO KÖNIG.....	221	SPUTACCHIERA.....	621
SIMS ISTEROMETRO.....	586	SPECILLO DI GUIDA SCANALATO BRUNNER.....	221	ST.CLAIR-THOMSON COLTELLO ADENOIDE.....	450
SIMS SPECILO RETTALE.....	559	SPECILLO DI GUIDA SCANALATO KIRSCHNER.....	221	ST.MARKS DIVARICATORE PELVICO.....	165
SIMS SPECILO VAGINALE.....	573	SPECILLO DI GUIDA SCANALATO SCHMIEDEN-PAYR.....	221	ST.MARTIN PINZA PER SUTURA.....	392
SIMS-MAIER PINZA PER MEDICATURA.....	134	SPECILLO DI GUIDA SCANALATO, BRUNNER.....	221	STACKE SPECILO AURICALE.....	199
		SPECILLO DI GUIDA SCANALATO, PAYR.....	221	STANDARD FORBICI PER CHIRURGIA.....	51

STAUDE-MOORE PINZA PER ABBASSARE IL COLLO			
DELL'UTERO .....	582		
STEINMANN CHIODI .....	307, 308		
STEINMANN PINZA PER AFFERRARE TENDINI .....	292		
STELLBRINK PINZA SGORBIA .....	234		
STERNBERG DIVARICATORE PER GUANCE .....	453		
SCALPELLO PER STERNO, LEBSCHÉ .....	267		
STETOSCOPIO, ANESTOPHON .....	23		
STETOSCOPIO, DUPLEX .....	23		
STETOSCOPIO, PINARD .....	23		
STETOSCOPIO .....	23		
STEVENS FORBICI PER OFTALMOLOGIA .....	58		
STEVENS PINZA PER IRIDE .....	383		
STEVENS PORT'AGHI .....	214		
STEVENS SUPERCUT FORBICI .....	72		
STEVENS UNCINO PER TENOTOMIA .....	375		
STEVENSON BLEFAROSTATO .....	371		
STIEGLITZ PINZA PER SCHEGGE .....	92		
STILLE CESOIA PER GESSI .....	229		
STILLE COSTOTOMO .....	480		
STILLE OSTEOTOMO .....	260		
STILLE PERFORATORE A MANO .....	298		
STILLE PINZA ANATOMICA .....	81		
STILLE PINZA CHIRURGICA .....	81/1		
STILLE PINZA EMOSTATICA .....	122		
STILLE SCALPELLO .....	260		
STILLE SGORBIA .....	260		
STILLE-BARRAYA PINZA VASCOLARE .....	88		
STILLE-HORSLEY CESOIA PER OSSA .....	242		
STILLE-LISTON CESOIA PER OSSA .....	242		
STILLE-LUER PINZA SGORBIA .....	239		
STILLE-RUSKIN PINZA SGORBIA .....	239		
STILLE-SHERMAN PERFORATORE A MANO .....	298		
STOCKMANN PINZA SERRAPENE .....	553/1		
STONE-WATT COMPRESSORE .....	545		
STRANDELL-STILLE DIVARICATORE .....	157		
STRATTE PORT'AGHI .....	212		
STRAUSS PINZA SERRAPENE .....	553/1		
STRUJEMPEL PINZA PER CORPI ESTRANEI .....	412		
STRULLY FORBICI PER NEUROCHIRURGIA .....	65		
STRUMENTI PER CORPI ESTRANEI, DIX .....	380		
STRUMENTO PER CIRCONCISIONE .....	556		
STRUMENTO PER MISURE .....	594		
STRUMENTO PER VARICI VARADY .....	202		
STRUMENTO TENDIFILI, DEMEL .....	315		
STRUMENTO TENDIFILI, LOUTE .....	315		
STRUYCKEN PINZA NASALE .....	427		
STUOIA IN SILICONE .....	616		
SUBRAMANIAN-MINIATURE PINZA PER AORTA			
PEDIATRICA .....	521		
SUPERCUT FORBICI .....	71		
SUPERCUT FORBICI IRIS .....	72		
SUPERCUT FORBICI KILNER .....	72		
SUPERCUT FORBICI LISTER .....	72		
SUPERCUT FORBICI REYNOLDS .....	72		
SUPERCUT FORBICI STEVENS .....	72		
SUPERCUT FORBICI WAGNER .....	72		
SUPERCUTFORBICI MAYO .....	71		
SUPERCUTFORBICI MAYO-STILLE .....	71		
SUPERCUTFORBICI METZENBAUM .....	71		
SUPERCUTFORBICI, BABY METZENBAUM .....	71		
SUPPORTO PER PETTO NEGUS .....	459		
SUPPORTO PER STERILIZZAZIONE FILI KIRSCHNER .....	305		
SUPPORTO PER TUBO .....	188		
SUPPORTO UNIVERSALE PER DIVARICATORI .....	188		
SUPPORTO UNIVERSALE PER ENDOSCOPIO .....	188		
SUPPORTO, ROCHARD .....	186		
SWEET PINZA POSA CLIPS .....	326		
SYSTRUNK FORBICI PER CHIRURGIA .....	66		
T			
TABB COLTELLO .....	418		
TAKAHASHI PINZA NASALE .....	427		
TAMBURO, SCHIMMELBUSCH .....	622		
TAMPONATORE, LUNIATSCHKEK .....	465		
TARNIER CRANIOCLASTO .....	607		
TARNIER FORCIPE .....	604		
TAYLOR - USA MARTELLO DA PERCUSSIONE .....	24		
TAYLOR DIVARICATORE SPINALE .....	291		
TAYLOR PINZA CHIRURGICA .....	87		
TC FORBICI PER CHIRURGIA FINE, REYNOLDS TC .....	54		
TC FORBICI PER CHIRURGIA STANDARD .....	51		
TC PINZA ANATOMICA .....	81		
TC PINZA CHIRURGICA .....	81		
TC PINZA CUSHING .....	83		
TC PINZA CUSHING TAYLOR .....	87		
TC PINZA GILLIES .....	86		
TC PINZA SEMKEN .....	86		
TC PINZA WANGENSTEEN .....	89		
TEALE PINZA PER ABBASSARE IL COLLO			
DELL'UTERO .....	583		
TEBBETS DIVARICATORE PER CHIRURGIA PLASTICA .....	197		
TELAIO PIEGABILE KIRSCHNER .....	187		
TENAGLIA PER OSSA .....	247		
TENAGLIA PER OSSA .....	249		
TENAGLIA PER OSSA BIRCHER-GANSKE .....	246		
TENAGLIA PER OSSA, ADSON .....	298		
TENAGLIA PER OSSA, LANE .....	246		
TENAGLIA PER OSSA, FARABEUF .....	243		
TENAGLIA PER OSSA, FARABEUF-L .....	243		
TENAGLIA PER OSSA, FERGUSSON .....	243		
TENAGLIA PER OSSA, KERN .....	244		
TENAGLIA PER OSSA, LAMBOTTE .....	244		
TENAGLIA PER OSSA, LANE .....	244		
TENAGLIA PER OSSA, LANGENBECK .....	243		
TENAGLIA PER OSSA, LEWIN .....	246		
TENAGLIA PER OSSA, MARTIN .....	246		
TENAGLIA PER OSSA, REILL .....	248		
TENAGLIA PER OSSA, SEMB .....	248		
TENAGLIA PER OSSA, ULRICH .....	248		
TENAGLIA PER OSSA, VAN BUREN .....	249		
TENAGLIA PER OSSA, VERBRUGGE .....	245		
TENAGLIE TAGLIAFILII .....	317, 318		
TERSON PINZA CAPSULARE .....	391		
TESSIER DIVARICATORE .....	463/3		
THOMAS CURETTE UTERINI .....	599		
THOMAS-GAYLOR PINZA PER BIOPSIA .....	588		
THOMS-ALLIS PINZA PER AFFERRARE INTESTINI .....	538		
THOMSON-WALKER DIVARICATORE VESCICALE .....	552		
THOREK, FORBICI TORACALI .....	65/2		
THUDICHUM SPECOLO NASALE .....	421		
TIECK-HALLE SPECOLO NASALE .....	423		
TILLEY PINZA AURICOLARE .....	411		
TIRAMIOMI, DOYEN .....	594		
TIRAVENE .....	202		
TISCHLER PINZA PER BIOPSIA .....	591		
TISCHLER-KEVORKIAN PINZA PER BIOPSIA .....	592		
TISCHLER-MORGAN PINZA PER BIOPSIA .....	590, 591		
TITAN PINZA EMOSTATICA, CRILE .....	107		
TITAN PINZA EMOSTATICA, KELLY .....	106		
TOBOLD ABBASSALINGUA .....	453		
TOBOLD PORTACOTONE .....	203		
TOENNIS DURA DISSETTORE .....	332		
TOENNIS PINZA EMOSTATICA .....	117		
TOENNIS-ADSON FORBICI PER NEUROCHIRURGIA .....	65		
TOGLILAMA .....	42		
TOHUKU PINZA FISSATELI .....	132		
TONOMETRO, SCHIÖETZ .....	394/2		
TONSILLOTOMO, SLUDER-BALLENGER .....	470		
TONSILLOTOMO, TYDING .....	469		
TOOK DISSETTORE CORNEALE .....	373		
TOURNIQUET RUMEL-BELMONT .....	528		
TOWNSEND PINZA PER BIOPSIA .....	591		
TOWNSEND MANICO SOLO .....	591		
TOYNBEE SPECOLO AURICOLARE .....	399		
TRASFORMATORE RICARICA BATTERIA .....	34		
TRATTORE, BARTON .....	603		
TRATTORE, BILL .....	604		
TRATTORE, LUIKART-BILL .....	604		
TRAVERS DIVARICATORE .....	172		
TREFINA CUTANEA, KEYES .....	608		
TRELAT SPECOLO VAGINALE .....	571		
TREQUARTO PER SENO MASCELLARE, COAKLEY .....	204		
TREQUARTO PER SENO MASCELLARE, LICHTWITZ .....	204		
TREQUARTO PER SENO MASCELLARE, PIERCE .....	204		
TREQUARTO PER SINOSCOPIA .....	205		
TREQUARTO PER SINOSCOPIA .....	205		
TREQUARTO, NELSON .....	205		
TREQUARTO, OCHSNER .....	205		
TREQUARTO, UNIVERSAL .....	204		
TREQUARTO, STANDARD (NELSON) .....	204		
TROELTSCH PINZA AURICOLARE .....	424		
TROEMNER PERKUSSIONSMARTELLO .....	24		
TRONCHESINA PER PELLE .....	610		
TRONCHESINA PER UNGHIE .....	612/1, 613		
TRONCHESINA PER UNGHIE ANVIL .....	613		
TRONCHESINA PER UNGHIE, TURNBULL .....	609		
TROUSSEAU DILATATORE TRACHEALE .....	476		
TROUSSEAU-BABY DILATATORE TRACHEALE .....	476		
TROUTMAN PINZA PER IRIDE .....	389		
TROUTMAN-CHRIS ROMPLAMETTE .....	45		
TUBBS DILATATORE .....	528		
TÜBINGEN PINZA PER FILO .....	392		
TUBO DI PROLUNGAMENTO, BRUENINGS .....	472		
TUFFIER DIVARICATORE .....	147		
TUFFIER DIVARICATORE COSTALE .....	487		
TUFFIER PINZA PER AFFERRARE TESSUTI .....	110		
TURNBULL TRONCHESINA PER UNGHIE .....	609		
TURREL PINZA INTESTINALE PER BIOPSIA .....	567		
TYDING PINZA PER TONSILLE .....	467, 468		
TYDING TONSILLOTOMO .....	469		
U			
UCKERMANN PORTACOTONE .....	203		
ULRICH PINZA PER MEDICATURA .....	135		
ULRICH TENAGLIA PER OSSA .....	248		
ULTRA-LIGHT-PINZA, ATRAUMATICA .....	95		
UNCINO ACUTO LAHEY .....	149		
UNCINO DI FISSAZIONE, BURCH .....	373		
UNCINO DIVARICATORE, KNAPP .....	375		
UNCINO DIVARICATORE, ROLLET .....	375		
UNCINO ESTRATTORE .....	322		
UNCINO ESTRATTORE, ARRUGA .....	375		
UNCINO GALEA, YASARGIL .....	330		
UNCINO GASS .....	376		
UNCINO KUGLEN .....	376		
UNCINO NASALE AUFRICHT .....	447		
UNCINO NASALE CONVERSE .....	448		
UNCINO NASALE UNCINO .....	447		
UNCINO NASALE, COTTLE .....	447		
UNCINO NASALE, MASING-NEIVERT .....	447		
UNCINO PER DURA MADRE, JACOBSON .....	335		
UNCINO PER DURAMADRE .....	335		
UNCINO PER DURAMADRE, ADSON .....	329		
UNCINO PER FISTOLE, EMMETT .....	594		
UNCINO PER IL STRABISMO, GRAEFE .....	375		
UNCINO PER IL STRABISMO, GREEN .....	375		
UNCINO PER IL STRABISMO, JAMESON .....	375		
UNCINO PER IRIDE, O'CONNOR .....	375		
UNCINO PER IRIDE, WIENER .....	375		
UNCINO PER LA PELLE GRAEFE .....	149		
UNCINO PER LA PELLE, COTTLE-NEIVERT .....	448		
UNCINO PER LA PELLE, FOMON .....	447/1		
UNCINO PER LA PELLE, FRAZIER .....	149		
UNCINO PER LA PELLE, FREER .....	448		
UNCINO PER LA PELLE, GILLIES .....	448		



UNCINO PER LA PELLE, GUTHRIE.....	149
UNCINO PER LA PELLE, JOSEPH.....	149
UNCINO PER LA PELLE, KILNER.....	608
UNCINO PER LA PELLE, KLEINERT-KUTZ.....	149
UNCINO PER LA PELLE, REDA.....	150
UNCINO PER LE PINNE NASALI LANGE.....	448
UNCINO PER MUSCOLI.....	267
UNCINO PER NERVI D'ERRICO.....	329/2
UNCINO PER NERVI, CRILE.....	328
UNCINO PER NERVI, CUSHING.....	328
UNCINO PER NERVI, DANDY.....	328
UNCINO PER NERVI, GRAHAM.....	329
UNCINO PER NERVI, HESS.....	329/1
UNCINO PER NERVI, KRAYENBUEHL.....	336
UNCINO PER NERVI, LOVE.....	329/2
UNCINO PER NERVI, SACHS.....	329
UNCINO PER NERVI, SMITHWICK.....	329
UNCINO PER RADICI DEI NERVI, HOLLSHER.....	329/1
UNCINO PER RADICI DEI NERVI, LOVE.....	330
UNCINO PER RADICI DEI NERVI, SCOVILLE.....	330
UNCINO PER TENOTOMIA, STEVENS.....	375
UNCINO SHAMBAUGH.....	419
UNCINO SINSKEY.....	376
UNCINO SPEZZATORE, BRAUN.....	607
UNCINO, BARBARA.....	419
UNCINO, DAY.....	409
UNCINO, FISCH.....	335
UNCINO, LUCAE.....	409
UNCINO, MCGEE.....	419
UNCINO, SMELLIE.....	605
UNCINO, WAGENER.....	409
UNI I COMBINAZIONE PER DIAGNOSTICA CON ILLUMINAZIONE STANDARD.....	13
UNI II COMBINAZIONE PER DIAGNOSTICA CON ILLUMINAZIONE STANDARD.....	14
UNI III COMBINAZIONE PER DIAGNOSTICA CON ILLUMINAZIONE STANDARD.....	15
UNIVERSAL FORBICI PER BENDAGGI.....	70
UNIVERSAL FORBICI PER FILO DI METALLO E LAMIERA.....	67
UNIVERSAL PINZA PER STERILIZZAZIONE.....	227
UNIVERSAL TREQUARTO.....	204
UNNA SCHIACCIACCOMEDONI.....	608
URETROTOMO OTIS.....	553
US ARMY DIVARICATORE.....	141
USA PINZA ANATOMICA.....	81
V	
VACUMENTRO PER VUOTI DI SANGUE.....	295
VALLEIX ISTEROMETRO.....	586
VALVE CON ADATTATORI AL TELAIO.....	194
VALVE, SCOVILLE.....	196
VAN BUREN CANDELETTA DILATATRICE.....	554
VAN BUREN TENAGLIA PER OSSA.....	249
VAN DOREN PINZA PER BIOPSIA.....	588
VANNAS FORBICI OCULISTICHE.....	79
VARADY STRUMENTO PER VARICI.....	202
VASSOIO PER PASTIGLIE.....	621
VERBRUGGE TENAGLIA PER OSSA.....	245
VERBRUGGE-MÜLLER ELEVATORE PER OSSA.....	286/2
VERESS AGO DI GUIDA.....	206
VIENNA SPECILLO DI GUIDA SCANALATO.....	221
VIRCHOW, COLTELLO PER CARTILAGINE E DISSEZIONE.....	48
VIRTUS(IRALK) PINZA PER SCHEGGE.....	92
VOLKMANN CURETTA TAGLIENTE.....	251
VOLKMANN CURETTA TAGLIENTE.....	257
VOLKMANN DIVARICATORE.....	153
VOLKMANN DIVARICATORE.....	154
VOLKMANN DIVARICATORE.....	156
VOLTOLINI SPECOLO NASALE.....	421
VU-MORE SPECOLO VAGINALE.....	569

W	
WACHENFELDT PINZA PER AGRAFES.....	224
WADSWORTH-TODD CAUTERIO.....	378
WAGENER-MOSHER CANNULA TRACHEALE.....	477
WAGENR UNCINO.....	409
WAGNER FORBICI GINGIVALI.....	67
WAGNER PINZA TAGLIENTE PER LAMINECTOMIA.....	343
WAGNER SUPERCUT FORBICI.....	72
WALLICH CUCCHIAIO PER ABORTO.....	607
WALSHAM PINZA PER RADDRIZZARE IL SETTO NASALE.....	449
WALTON SGORBIA PER CORPI ESTRANEI.....	374
WALTON SCHIACCIACCOMEDONI.....	608
WALTON SEGA TAGLIA ANELLI.....	297
WANGENSTEEN PINZA VASCOLARE.....	89
WANGENSTEEN PORT'AGHI.....	210
WARTENBERG ALGESIMETRO.....	25
WATSON DERMATOMO.....	50
WATSON-CHEYNE ELEVATORE.....	283
WATSON-CHEYNE SPECILLO.....	199
WATSON-WILLIAMS PINZA NASALE.....	428
WAUGH PINZA CHIRURGICA.....	83
WEBER ANSA PER CATERATTA.....	378
WEBER PINZA PER AORTA.....	501
WEBSTER PORT'AGHI.....	208
WECKER FORBICI OCULISTICHE.....	75
WECKER SPATOLA PER IRIDE.....	378
WEEK BLEFAROSTATO.....	370
WEIL-BLAKESLEY PINZA NASALE.....	426
WEITLANER DIVARICATORE.....	169
WEITLANER-WULLSTEIN DIVARICATORE.....	169
WELLER, FORBICI PER DISSEZIONE.....	53/2
WELLS CUCCHIAIO PER ENUCLEAZIONE.....	378
WERTHEIM FORBICI PER ISTERECTOMIA.....	63
WERTHEIM PINZA PER ISTERECTOMIA.....	124
WERTHEIM PINZA PER ISTERECTOMIA.....	128
WERTHEIM-CULLEN PINZA PER PEDUNCOLO RENALE.....	125
WESTCOTT FORBICI OCULISTICHE.....	75
WESTMACOTT PINZA NASALE PER TAMPONI.....	424
WESTON SERRANODI RETTALE.....	566
WHEELER COLTELLO LANCEOLARE.....	373
WHEELER SPATOLA PER CICLODIALISI.....	379
WHITE PINZA PER TONSILLE.....	467
WIEDER ABBASSALINGUA.....	452
WIENER RASPA NASALE.....	443
WIENER UNCINO PER IRIDE.....	375
WIGMORE COLTELLO PER GESSI.....	229
WIKSTROEM PINZA EMOSTATICA.....	117
WILDE SERRANODI.....	411
WILDE SERRANODI.....	433/2
WILDE(TROELTSCH) PINZA AURICOLARE.....	410
WILDER ANSA PER CATERATTA.....	378
WILLET MARTEL PINZA DA PRESA.....	110
WILLIAMS BLEFAROSTATO.....	370
WILLIAMS CACCIAVITE.....	323
WILLIAMS PINZA PER AFFERRARE INTESTINI.....	539
WILLIGER CURETTA TAGLIENTE.....	255
WILLIGER MARTELLO.....	271
WILLIGER PERIOTOTOMO.....	276
WINTER PINZA PER ABORTO.....	606
WITTNER PINZA PER BIOPSIA.....	589
WOLFF PINZA STRAPPAGESSI.....	233
WOODSON DURA DISSETTORE.....	333
WORST, SONDA.....	381
WRIGLEY FORCIPE.....	602
WULLSTEIN COLTELLO.....	418
WULLSTEIN DIVARICATORE.....	171
WULLSTEIN MANICO D'ASPIRAZIONE.....	338
WULLSTEIN MICRO PINZA AURICOLARE A CUCCHIAIO.....	416
WYLLIE DILATATORE UTERINO.....	581

Y	
YANCOSKIE DIVARICATORE PER CHIRURGIA PLASTICA.....	198
YANKAUER DISSETTORE PER TONSILLE.....	465
YASARGIL CANNULA D'ASPIRAZIONE.....	337/2
YASARGIL CLIPS PER ANEURISMA.....	345 - 356
YASARGIL PINZA PER TUMORI.....	97
YASARGIL UNCINO GALEA.....	330
YEOMAN PINZA INTESTINALE PER BIOPSIA.....	566, 567
YOUNG BOOMERANG PER SUTURE.....	220
YOUNG DIVARICATORE PER LA PROSTATA.....	550
YOUNG PINZA TIRALINGUA.....	453
Z	
ZAUFAL ELEVATORE AURICOLARE.....	409
ZAUFAL-JANSEN ELEVATORE AURICOLARE.....	409
ZAUFAL-JANSEN PINZA SGORBIA.....	238
ZENKER DIVARICATORE.....	161
ZENKER PINZA EMOSTATICA.....	118
ZIEGLER BLEFAROSTATO.....	371
ZIEGLER COLTELLO LANCEOLARE.....	373
ZIEGLER COLTELLO PER IRIDE.....	372
ZIEGLER DILATATORE PER CANALE LACRIMALE.....	381
ZIEGLER SPECCHIO FRONTALE.....	21
ZIELKE SGORBIA.....	264
ZÖLLNER CANNULA D'ASPIRAZIONE.....	337/2