



## RESPIRATORY CARE

Combined Heat and Moisture Exchangers  
Bacterial/Viral Air Filters  
Catheter Mounts



## **TELEFLEX RESPIRATORY CARE – EFFECTIVE PATIENT PROTECTION IN ANAESTHESIA & ICU**

Trusted brands make Teleflex an economical and strong partner. Built on a solid tradition of innovation, Teleflex is a global leader in superior medical supplies designed to help providers minimise risk and maximise outcomes for their patients. Our understanding of the importance to our customers of a full range of devices has led to the development of a unique line of products, all of which complement one another.

Optimum moisture output coupled with low resistance to flow, cross-contamination protection thanks to outstanding filtration efficiency, low dead-space and light weight are known to be the outstanding features of filtration and humidification systems provided by the Teleflex brand GIBECK. The GIBECK range of products, such as bacterial/viral filters and combined Heat & Moisture Exchangers/Filters (HMEFs) presented to you together with a choice of complementary catheter mounts from rÜSCH, offers you a wide array of configuration options and performance capabilities and enable you to meet the unique challenges of anaesthesia, intensive care and emergency care.

You can find further details and the technical specifications of our products within this brochure.

**TELEFLEX – HIGH QUALITY MEDICAL SUPPLIES FROM A SINGLE SOURCE**



## INTRODUCTION

Teleflex Respiratory Care .....	4
---------------------------------	---

## GIBECK COMBINED HME/FILTER

Humid-Vent filter family .....	6
Humid-Vent HEPA .....	7

## GIBECK BACTERIAL/VIRAL FILTER

Iso-Gard filter family .....	8
------------------------------	---

## RÜSCH CATHETER MOUNTS

Smoothbore type flextube .....	10
Expandable type flextube .....	12

## GIBECK COMBINATIONS OF HMEFs, BACTERIAL/VIRAL FILTERS & CATHETER MOUNTS

Humid-Vent filter compact .....	14
Humid-Vent filter small .....	16
ISO-Gard filter .....	17
ISO-Gard filter small .....	18
ISO-Gard HEPA light .....	18
ISO-Gard HEPA small .....	18

Index .....	19
-------------	----

**LATEX FREE**

All products in this catalogue are free of latex.

**PVC FREE**

All products (except the smoothbore tubing) in this catalogue are free of PVC.

**PHTHALATE FREE**

All products in this catalogue are free of phthalates.

**ECO-FRIENDLY**

The residues from incineration of the different GIBECK products consist of carbon dioxide and water. The incineration of a Humid-Vent Filter Compact (31 g) produces 96 g of CO<sub>2</sub>, equal to an exhalation of 240 minutes of breathing. A human being (70 kg) exhales an average of 24 g CO<sub>2</sub> per hour.

**SAFETY FEATURES**

- filtration tested in independent laboratories
- excellent humidification according to ISO 9360 standard
- low dead space
- lightweight
- well documented
- original “Swedish nose”
- product quality validation sheet

## GIBECK FILTERS FOR AIRWAY PROTECTION AND PREVENTION OF NOSOCOMIAL INFECTIONS

Without effective protection, patients run a greater risk of infection due to Gram-negative bacteria and viruses. In fact, the incidence of nosocomial infections in patients admitted to ICU's and thus exposed to such gas flows is 5 to 10-fold higher than those in general wards.

GIBECK supplies a range of pleated and flat breathing filters as well as filters combined with Heat & Moisture Exchangers.

The GIBECK range of breathing filters has been independently tested and proven to be highly efficient in preventing the passage of bacteria and viruses such as *Mycobacterium tuberculosis*, *Hepatitis C*, *HIV*, *Serratia marcescens*, *Staphylococcus aureus*, *Bacillus subtilis*, *Pseudomonas aeruginosa* and *MS-2 coliphage*. (The efficiency is not affected by humidity and/or anaesthetic gases).

All GIBECK filters are manufactured according to ISO 9001 and presented with a validation certificate. They are tested for integrity and efficiency in compliance with existing international standards.

## GIBECK COMBINED HEAT & MOISTURE EXCHANGERS (HMEFs)

The Humid-Vent product family is developed from the true original passive humidifier called “Swedish Nose”, invented by GIBECK more than 30 years ago. The HMEFs are developed to be used patient-close both in ICU and Anaesthesia. Different sizes and designs optimise the efficiency for both children and adults, for short term as well as for long term use.

The HMEFs give outstanding performance and provide humidification properties similar to the ISO standard for active humidifiers (30 mg H<sub>2</sub>O/l gas). Yet they are lightweight and small. The GIBECK HMEFs combine the best of optimal filtration and humidification efficiency in products with minimal dead space and low resistance to flow.

## RÜSCH CATHETER MOUNTS

To fulfill all possible clinical needs, you will find the market's largest choice of different catheter mounts combinations in this catalogue. These combinations consist of several elbow and swivel connectors for aspiration, bronchoscopy and capnography.

Premounted sets with GIBECK HMEFs or Bacteria/Viral filters save time and optimise procedures. These ready-to-use airtight combinations are especially safe and comfortable.

The product range includes three different kinds of flextubes:

### SMOOTHBORE

Smoothbore tubing has a flat inside surface with several advantages such as low resistance to flow and low tubing compliance. Our smoothbore tubing is transparent as well as resistant to kinking. The inside surface reduces water collection thus rendering the climate unfavourable for bacteria and preventing infection growth. The smoothbore catheter mounts are available in various configurations individually as well as packed together with GIBECK HMEFs and Bacteria/Viral filters.

### EXPANDABLE (CLIC CLAC)

The high-quality stretchable design allows the mount to be set and fixed in several positions. This saves storage space and diminishes the dead space at patient side. Its lengths can be adjusted from 9 cm to 15 cm. Resistant to kinking. The expandable catheter mounts are available in various configurations individually as well as packed together with GIBECK HMEFs and filters.

### CORRUGATED

The corrugated flextube is distinguished by maximum elasticity and flexibility. It is available in configurations with GIBECK HMEF combinations (Humid-Vent Filter Compact and Humid-Vent Filter Small).

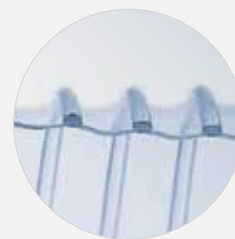

SMOOTHBORE

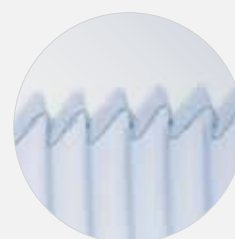

EXPANDABLE

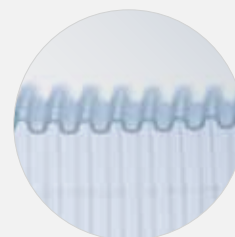

CORRUGATED

# GIBECK COMBINED HME/FILTER

## HUMID-VENT® FILTER FAMILY

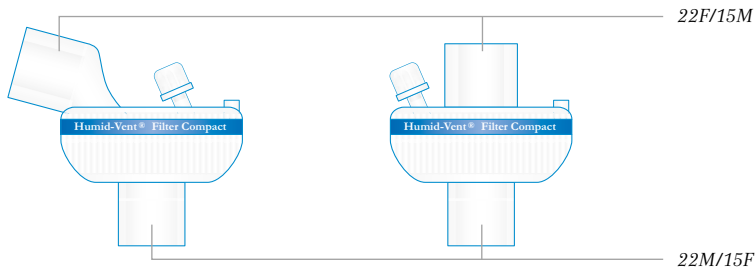

### HUMID-VENT FILTER COMPACT

Gibeck

REF.	DESCRIPTION	FILTER EFFICIENCY %	MOISTURE LOSS (MG H <sub>2</sub> O/L)	MOISTURE OUTPUT (MG H <sub>2</sub> O/L)	WEIGHT (G)	RESISTANCE (CM H <sub>2</sub> O)	DEAD SPACE (ML)	QTY
18401	angled, sterile	>99.99999 (bacteria) >99.999 (virus) >99.999 (tuberculosis)	6 Vt 500	31 Vt 500	31 (straight) 32 (angled)	1.8 at 60l/min	35 (straight) 38 (angled)	25
18402	angled, clean		7 Vt 750	30 Vt 750				25
19401	straight, sterile		7 Vt 1000	30 Vt 1000	25			
19402	straight, clean		25					

Validated against HIV and Hepatitis C

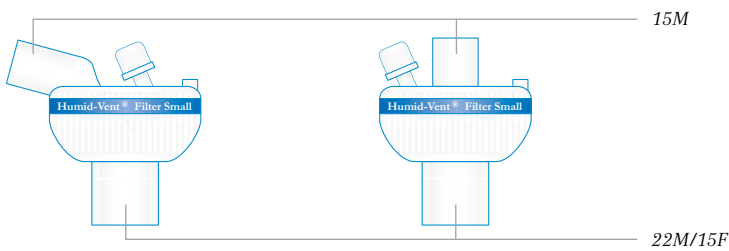

### HUMID-VENT FILTER SMALL

Gibeck

REF.	DESCRIPTION	FILTER EFFICIENCY %	MOISTURE LOSS (MG H <sub>2</sub> O/L)	MOISTURE OUTPUT (MG H <sub>2</sub> O/L)	WEIGHT (G)	RESISTANCE (CM H <sub>2</sub> O)	DEAD SPACE (ML)	QTY
18501	angled, sterile	>99.9999 (bacteria) >99.999 (virus)	6 Vt 500	31 Vt 500	21 (straight) 22 (angled)	2.1 at 60l/min	26 (straight) 27 (angled)	20
18502	angled, clean		7 Vt 750	30 Vt 750				20
19501	straight, sterile		8 Vt 1000	29 Vt 1000	20			
19502	straight, clean		20					

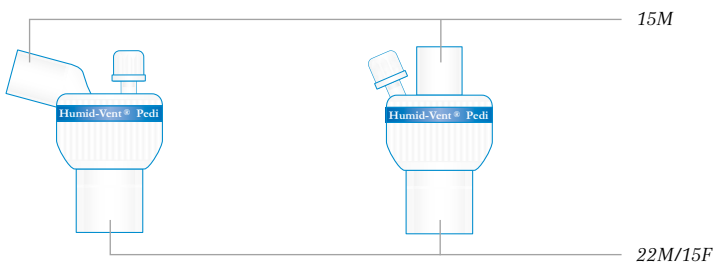

**HUMID-VENT FILTER PEDI**



REF.	DESCRIPTION	FILTER EFFICIENCY %	MOISTURE LOSS (MG H <sub>2</sub> O/L)	MOISTURE OUTPUT (MG H <sub>2</sub> O/L)	WEIGHT (G)	RESISTANCE (CM H <sub>2</sub> O)	DEAD SPACE (ML)	QTY
11011	angled, sterile	>99.99999 (bacteria) >99.99 (virus)	6 Vt 250	33 Vt 50 30 Vt 100 30 Vt 250	13.5 (straight) 14.5 (angled)	1.4 at 20l/min	12 (straight) 13 (angled)	20
11012	angled, clean							20
12011	straight, sterile							20
12012	straight, clean							20

**HUMID-VENT® HEPA**

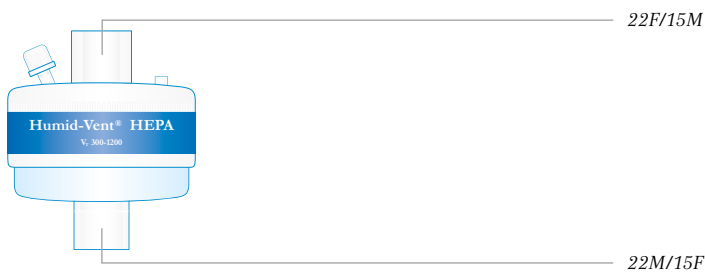

**HUMID-VENT HEPA (COMBINED HME & PLEATED HEPA FILTER)**

REF.	DESCRIPTION	FILTER EFFICIENCY %	MOISTURE LOSS (MG H <sub>2</sub> O/L)	MOISTURE OUTPUT (MG H <sub>2</sub> O/L)	WEIGHT (G)	RESISTANCE (CM H <sub>2</sub> O)	DEAD SPACE (ML)	QTY
29001	straight, sterile	> 99.99999 (bacteria) >99.9999 (virus) >99.999 (tuberculosis)	6.7 Vt 500	30.3 Vt 500	53	1.1 at 30l/min 2.6 at 60l/min	81	20
29002	straight, clean		6.6 Vt 1000	31.8 Vt 1000				20

Filter media validated against HIV and Hepatitis C

Many products are also available with a tethered CO<sub>2</sub> cap (blue soft cap attached by a string attachment). To order please add "T" after the code

# GIBECK BACTERIAL/VIRAL FILTERS

## ISO-GARD® FILTER FAMILY

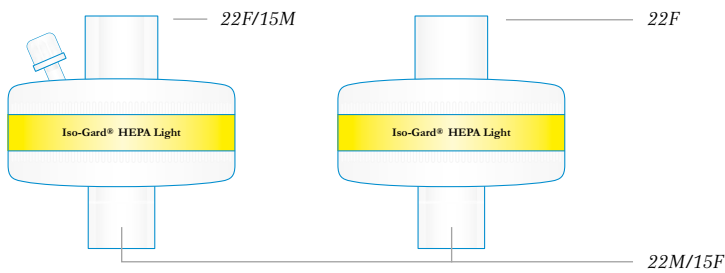

### ISO-GARD HEPA LIGHT (PLEATED, WITH HEAT AND MOISTURE PROPERTIES)

REF.	DESCRIPTION	FILTER EFFICIENCY %	MOISTURE LOSS (MG H <sub>2</sub> O/L)	MOISTURE OUTPUT (MG H <sub>2</sub> O/L)	WEIGHT (G)	RESISTANCE (CM H <sub>2</sub> O)	DEAD SPACE (ML)	QTY
28001	straight, sterile	>99.9999 (bacteria) >99.9999 (virus) >99.999 (tuberculosis) HEPA class 13 (>99.97)	9 Vt 500	28 Vt 500	38	2.8 at 60l/min	80	20
28002	straight, clean							20
28012*	straight, clean							20
28022**	straight, clean							20

\*without CO<sub>2</sub> port    \*\*Machine version, 22F connector    Validated against HIV and Hepatitis C

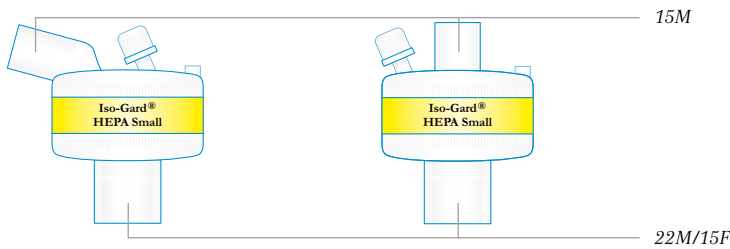

### ISO-GARD HEPA SMALL (PLEATED, WITH HEAT AND MOISTURE PROPERTIES)

**Gibeck**

REF.	DESCRIPTION	FILTER EFFICIENCY %	MOISTURE LOSS (MG H <sub>2</sub> O/L)	MOISTURE OUTPUT (MG H <sub>2</sub> O/L)	WEIGHT (G)	RESISTANCE (CM H <sub>2</sub> O)	DEAD SPACE (ML)	QTY
28051	angled, sterile	>99.9999 (bacteria) >99.9999 (virus) >99.999 (tuberculosis) HEPA class 13 (>99.97)	7 Vt 250 13 Vt 50	30 Vt 250 24 Vt 500	22 (straight) 23 (angled)	2.3 at 30l/min	29 (straight) 31 (angled)	25
28052	angled, clean							25
28061	straight, sterile							25
28062	straight, clean							25



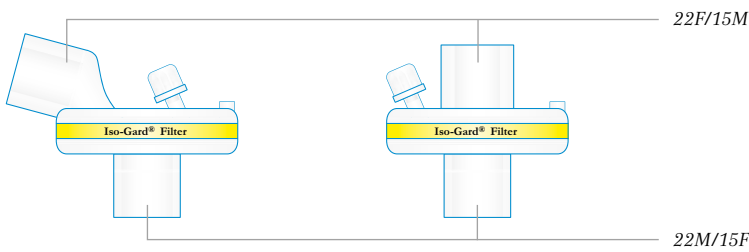

**ISO-GARD FILTER**

**Gibeck**

REF.	DESCRIPTION	FILTER EFFICIENCY %	MOISTURE LOSS (MG H <sub>2</sub> O/L)	MOISTURE OUTPUT (MG H <sub>2</sub> O/L)	WEIGHT (G)	RESISTANCE (CM H <sub>2</sub> O)	DEAD SPACE (ML)	QTY
18211	angled, sterile	>99.9999 (bacteria) >99.999 (virus)	N/A	N/A	22 (straight) 23 (angled)	1.6 at 60l/min	26 (straight) 30 (angled)	25
18212	angled, clean							25
19211	straight, sterile							25
19212	straight, clean							25

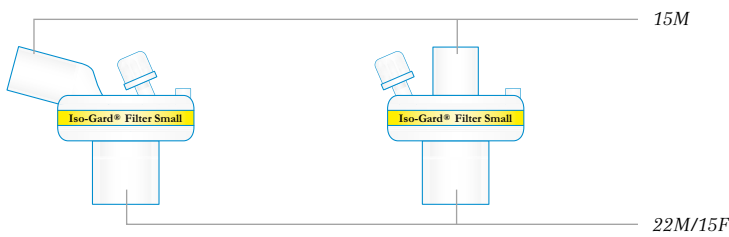

**ISO-GARD FILTER SMALL**

**Gibeck**

REF.	DESCRIPTION	FILTER EFFICIENCY %	MOISTURE LOSS (MG H <sub>2</sub> O/L)	MOISTURE OUTPUT (MG H <sub>2</sub> O/L)	WEIGHT (G)	RESISTANCE (CM H <sub>2</sub> O)	DEAD SPACE (ML)	QTY
18511	angled, sterile	> 99.99999 (bacteria) >99.999 (virus)	N/A	N/A	15 (straight) 16 (angled)	1.9 at 60l/min	20 (straight) 21 (angled)	20
18512	angled, clean							20
19511	straight, sterile							20
19512	straight, clean							20

Many products are also available with a tethered CO<sub>2</sub> cap (blue soft cap attached by a string attachment). To order please add "T" after the code

# RÜSCH CATHETER MOUNTS

## SMOOTHBORE CATHETER MOUNT

### WITH STRAIGHT CONNECTOR

REF.	MACHINE-SIDE CONNECTOR	DESCRIPTION	LENGTH	QTY
191018	15M	clean	15 cm	25
191019	15M	sterile	5 cm 10 cm 15 cm 20 cm	25
191020	22F	clean	10 cm 15 cm 20 cm 30 cm 40 cm	25
191021	22F	sterile	5 cm 10 cm 15 cm 20 cm 40 cm	25

### WITH ELBOW CONNECTOR

REF.	MACHINE-SIDE CONNECTOR	DESCRIPTION	LENGTH	QTY
191009	15M	sterile	5 cm 10 cm 15 cm	25
191024	22F	clean	10 cm 15 cm	25
191020	22F	sterile	5 cm 10 cm 15 cm 40 cm	25

### WITH ELBOW CONNECTOR AND LUER-LOCK PORT FOR CO<sub>2</sub> SAMPLING. IDEAL FOR ANESTHESIA.

REF.	MACHINE-SIDE CONNECTOR	DESCRIPTION	LENGTH	QTY
191008	15M	sterile	10 cm 15 cm 20 cm	25
191022	22F	clean	15 cm	25
191023	22F	sterile	15 cm	25

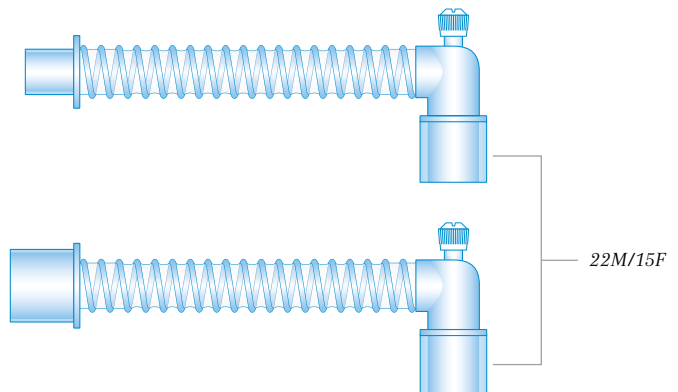
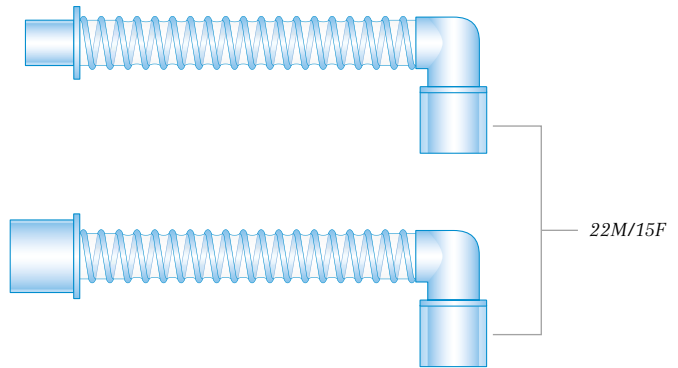
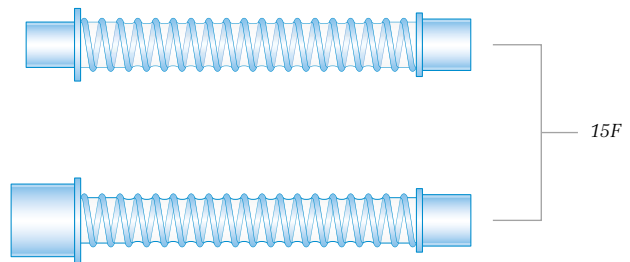

When ordering, please always indicate reference number and required length.

**WITH DOUBLE SWIVEL AND ELBOW CONNECTOR.  
WITHOUT SUCTION PORT.**

REF.	MACHINE-SIDE CONNECTOR	DESCRIPTION	LENGTH	QTY
191012	15M	clean	10 cm 15 cm 20 cm	25
191013	15M	sterile	10 cm 15 cm 20 cm 30 cm	25
191727	22F	clean	15 cm 20 cm	25
191729	22F	sterile	15 cm 20 cm	25

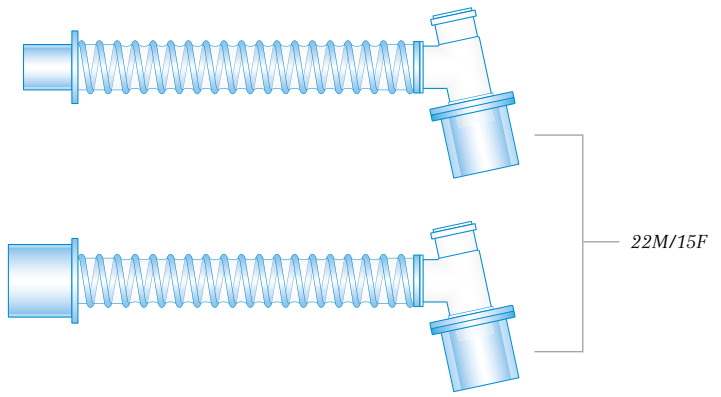

**WITH FIXED COBB ELBOW AND SEALING CAP.  
IDEAL FOR ANESTHESIA.**

REF.	MACHINE-SIDE CONNECTOR	DESCRIPTION	LENGTH	QTY
191653	15M	clean	5 cm 10 cm 15 cm 20 cm 30 cm	25
191652	22F	sterile	5 cm 10 cm 15 cm 20 cm	25

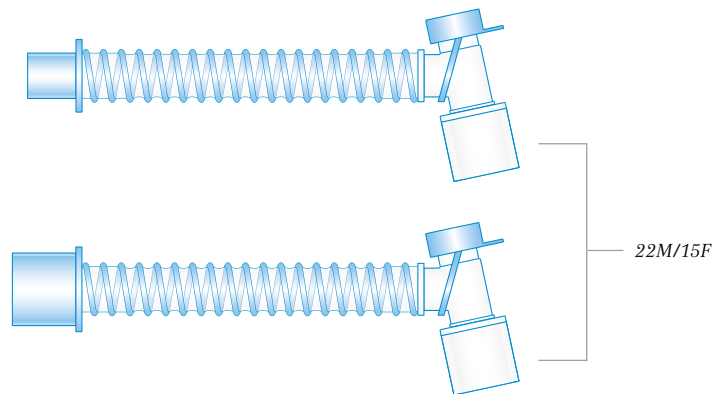

**WITH DOUBLE SWIVEL CONNECTOR. SEAL-AROUND 9 MM CAP FOR FIBER-OPTIC BRONCHOSCOPY AND 3.5 MM PORT FOR SUCTIONING. IDEAL FOR INTENSIVE CARE UNIT.**

REF.	MACHINE-SIDE CONNECTOR	DESCRIPTION	LENGTH	QTY
191010	15M	clean	10 cm 15 cm 20 cm	25
191011	15M	sterile	5 cm 10 cm 15 cm 20 cm 30 cm 50 cm	25
191014	22F	clean	10 cm 15 cm 20 cm 40 cm	25
191015	22F	sterile	5 cm 10 cm 15 cm 20 cm 40 cm	25
191771 027015*	15F	sterile	15 cm	25

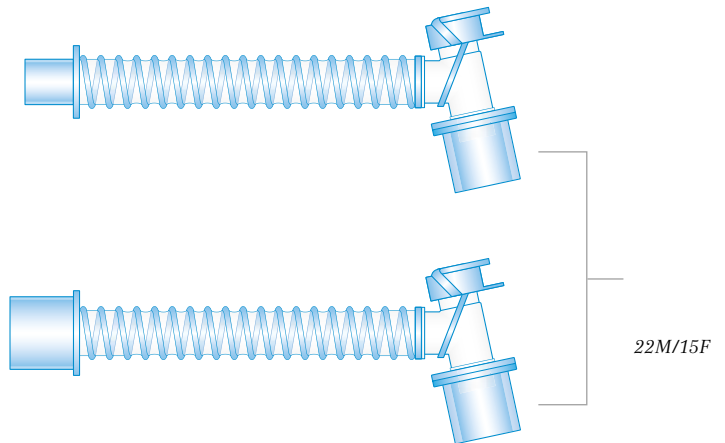

\*15F connector on machine side for easy attachment to nebuliser.

**EXPANDABLE CATHETER MOUNT**

**WITH STRAIGHT CONNECTOR**

REF.	MACHINE-SIDE CONNECTOR	DESCRIPTION	LENGTH	QTY
191045	15M	sterile	9-15 cm	25
191039	15M	clean	9-15 cm	25
191041	22F	sterile	9-15 cm	25
191040	22F	clean	9-15 cm	25

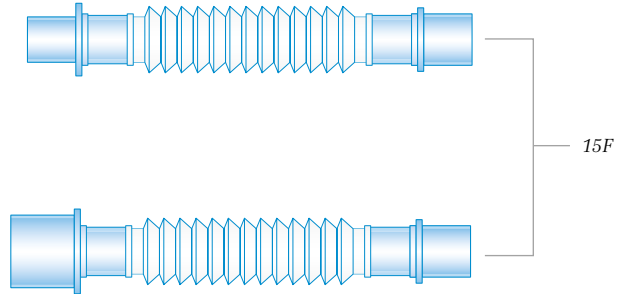

**WITH ELBOW CONNECTOR**

REF.	MACHINE-SIDE CONNECTOR	DESCRIPTION	LENGTH	QTY
191735	15M	sterile	9-15 cm	25
191734	15M	clean	9-15 cm	25
191044	22F	sterile	9-15 cm	25
191043	22F	clean	9-15 cm	25

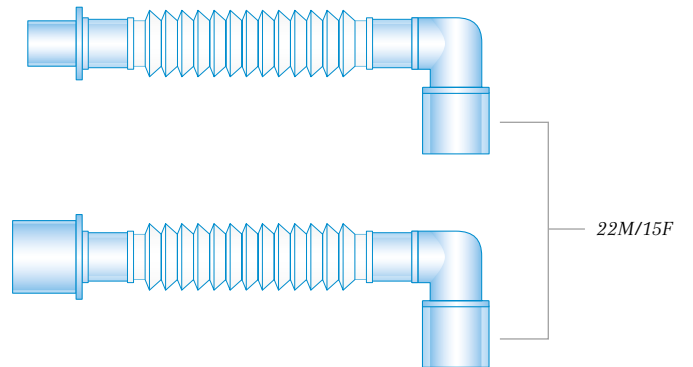

**WITH ELBOW CONNECTOR AND LUER-LOCK PORT FOR CO<sub>2</sub> SAMPLING.**

REF.	MACHINE-SIDE CONNECTOR	DESCRIPTION	LENGTH	QTY
191585	15M	sterile	9-15 cm	25
191586	15M	clean	9-15 cm	25
191046	22F	sterile	9-15 cm	25

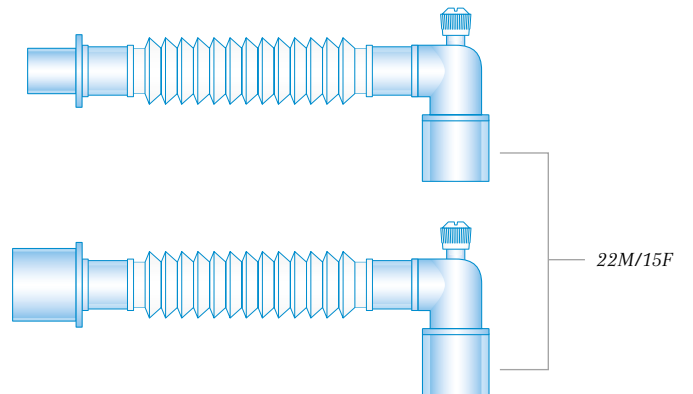

WITH FIXED COBB ELBOW AND SEALING CAP.  
IDEAL FOR ANAESTHESIA.

REF.	MACHINE-SIDE CONNECTOR	DESCRIPTION	LENGTH	QTY
191081	15M	sterile	9-15 cm	25
191533	22F	sterile	9-15 cm	25
191534	22F	clean	9-15 cm	25

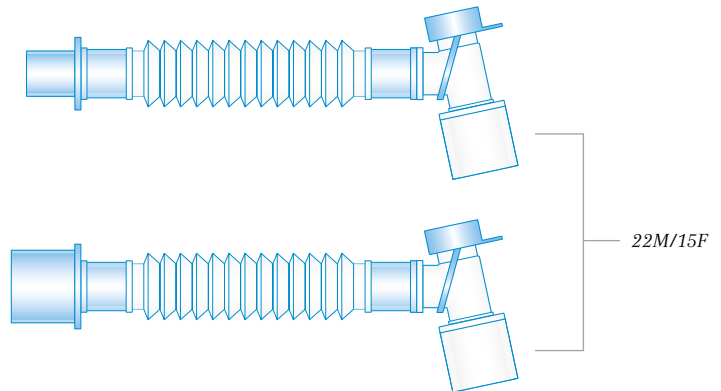

WITH DOUBLE SWIVEL CONNECTOR. SEAL-AROUND  
9 MM CAP FOR FIBER-OPTIC BRONCHOSCOPY AND 3.5 MM  
PORT FOR SUCTIONING. IDEAL FOR INTENSIVE CARE UNIT.

REF.	MACHINE-SIDE CONNECTOR	DESCRIPTION	LENGTH	QTY
191033	15M	sterile	9-15 cm	25
191034	15M	clean	9-15 cm	25
191037	22F	sterile	9-15 cm	25
191036	22F	clean	9-15 cm	25

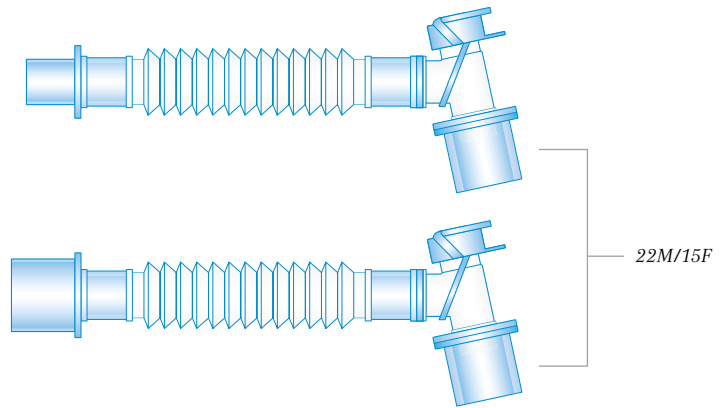

### EXPANDABLE CATHETER MOUNT

- adjustable length
- memory shape
- minimises dead space at bedside
- little storage space required
- kink-resistant



# GIBECK COMBINATIONS OF HME/FILTER & CATHETER MOUNTS

## HUMID-VENT® FILTER COMPACT WITH SMOOTHBORE CATHETER MOUNT

### WITH STRAIGHT CONNECTOR AND CAP

REF.	MACHINE-SIDE CONNECTOR	DESCRIPTION	LENGTH	QTY
19811	22F/15M	sterile	20 cm	25
19812	22F/15M	clean	20 cm	25

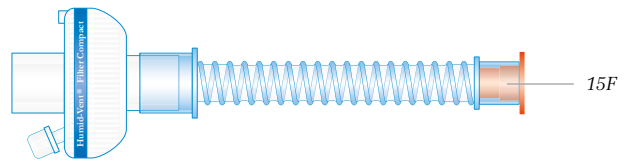

### WITH ELBOW CONNECTOR

REF.	MACHINE-SIDE CONNECTOR	DESCRIPTION	LENGTH	QTY
191302*	22F/15M	clean	15 cm	50

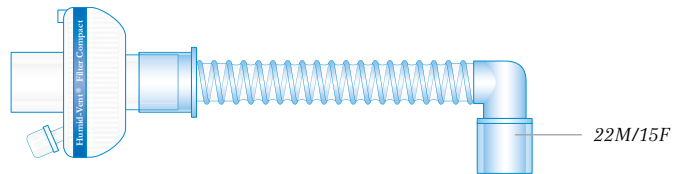

### WITH WITH FIXED COBB ELBOW AND SEALING CAP

REF.	MACHINE-SIDE CONNECTOR	DESCRIPTION	LENGTH	QTY
191655	22F/15M	sterile	5 cm 10 cm 15 cm 20 cm	25
191654	22F/15M	clean	15 cm	25

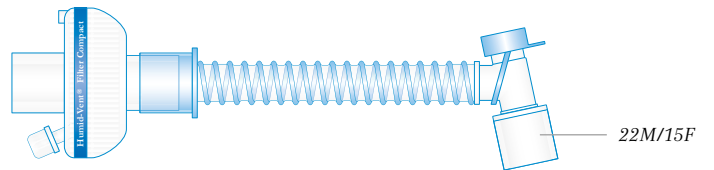

### WITH DOUBLE SWIVEL CONNECTOR. WITHOUT SUCTION PORT.

REF.	MACHINE-SIDE CONNECTOR	DESCRIPTION	LENGTH	QTY
191738	22F/15M	sterile	15 cm	25
191739	22F/15M	clean	15 cm	25

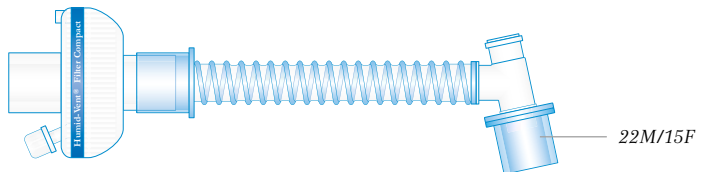

### WITH DOUBLE SWIVEL CONNECTOR. SEAL-AROUND PORT FOR SUCTIONING. IDEAL FOR INTENSIVE CARE UNIT.

REF.	MACHINE-SIDE CONNECTOR	DESCRIPTION	LENGTH	QTY
191658	22F/15M	sterile	5 cm 10 cm 15 cm 25 cm	25
191657	22F/15M	clean	10 cm 15 cm	25
19061 (not mounted)	22F/15M	sterile	15 cm	25
19062 (not mounted)	22F/15M	clean	15 cm	25

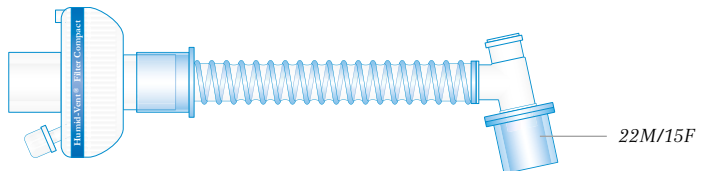

\*When ordering, please indicate code 191302-500150.

**HUMID-VENT® FILTER COMPACT WITH EXPANDABLE CATHETER MOUNT**

**WITH STRAIGHT CONNECTOR AND CAP**

REF.	MACHINE-SIDE CONNECTOR	DESCRIPTION	LENGTH	QTY
191611	22F/15M	sterile	9-15 cm	25
19612	22F/15M	clean	9-15 cm	25
19621 (not mounted)	22F/15M	sterile	9-15 cm	25
19622 (not mounted)	22F/15M	clean	9-15 cm	25

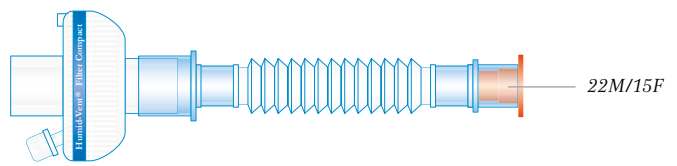

**WITH ELBOW CONNECTOR**

REF.	MACHINE-SIDE CONNECTOR	DESCRIPTION	LENGTH	QTY
19092	22F/15M	clean	9-15 cm	25

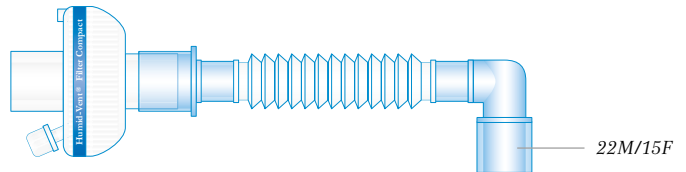

**WITH CONNECTOR. SEAL-AROUND 9MM CAP AND 3.5MM PORT FOR SUCTIONING. IDEAL FOR INTENSIVE CARE UNIT.**

REF.	MACHINE-SIDE CONNECTOR	DESCRIPTION	LENGTH	QTY
19141	22F/15M	sterile	9-15 cm	25
19142	22F/15M	clean	9-15 cm	25
19042 (not mounted)	22F/15M	clean	9-15 cm	25

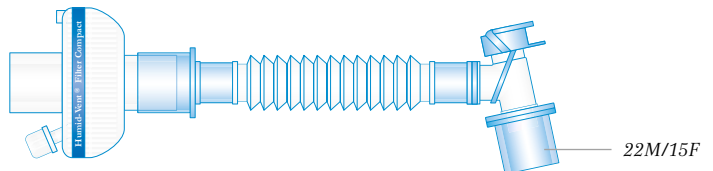

When ordering, please always indicate reference number and required length.

**HUMID-VENT® FILTER COMPACT WITH CORRUGATED CATHETER MOUNT**

**WITH STRAIGHT CONNECTOR AND CAP**

REF.	MACHINE-SIDE CONNECTOR	DESCRIPTION	LENGTH	QTY
19432 (not mounted)	22F/15M	clean	15 cm	25

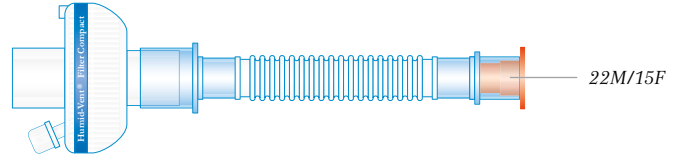

**WITH ELBOW CONNECTOR**

REF.	MACHINE-SIDE CONNECTOR	DESCRIPTION	LENGTH	QTY
19882	22F/15M	clean	15 cm	25

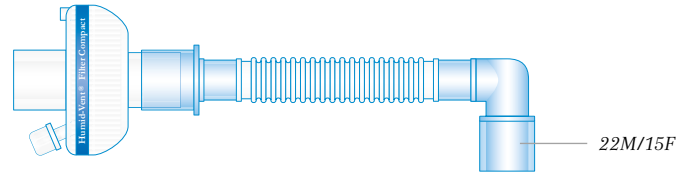

**WITH DOUBLE SWIVEL CONNECTOR. SEAL-AROUND 9MM CAP AND 3.5MM PORT FOR SUCTIONING. IDEAL FOR INTENSIVE CARE UNIT**

REF.	MACHINE-SIDE CONNECTOR	DESCRIPTION	LENGTH	QTY
19412	22F/15M	clean	15 cm	25

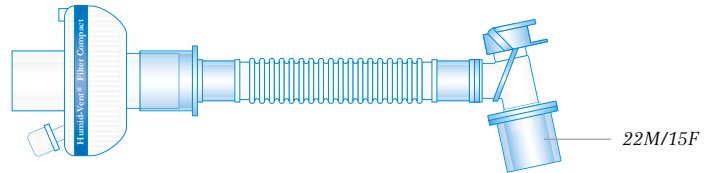

**HUMID-VENT® FILTER SMALL WITH SMOOTHBORE CATHETER MOUNT**

**WITH FIXED COBB ELBOW AND SEALING CAP**

REF.	MACHINE-SIDE CONNECTOR	DESCRIPTION	LENGTH	QTY
191345	22F/15M	sterile	5 cm	25

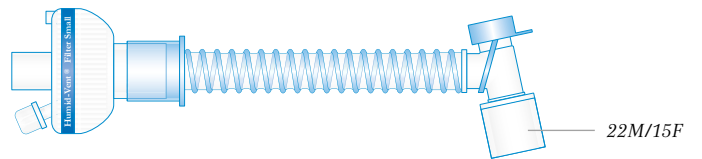

**HUMID-VENT® FILTER SMALL WITH EXPANDABLE CATHETER MOUNT**

**WITH STRAIGHT CONNECTOR AND CAP**

REF.	MACHINE-SIDE CONNECTOR	DESCRIPTION	LENGTH	QTY
19522 (not mounted)	22F/15M	clean	9-15 cm	25

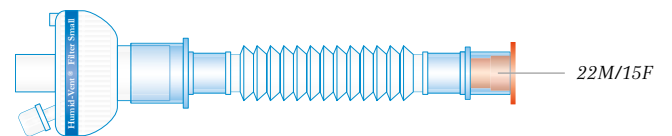

**WITH ELBOW CONNECTOR**

REF.	MACHINE-SIDE CONNECTOR	DESCRIPTION	LENGTH	QTY
19661	22F/15M	sterile	9-15 cm	25
19662	22F/15M	clean	9-15 cm	25
19772 (not mounted)	22F/15M	clean	9-15 cm	25

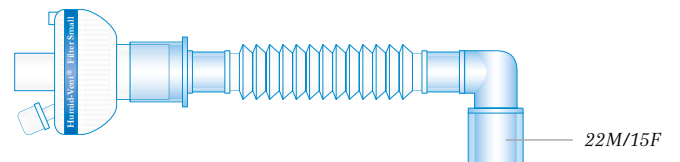

**WITH DOUBLE SWIVEL CONNECTOR. SEAL-AROUND 9MM CAP AND 3.5MM PORT FOR SUCTIONING. IDEAL FOR INTENSIVE CARE UNIT.**

REF.	MACHINE-SIDE CONNECTOR	DESCRIPTION	LENGTH	QTY
19052 (not mounted)	22F/15M	clean	9-15 cm	25

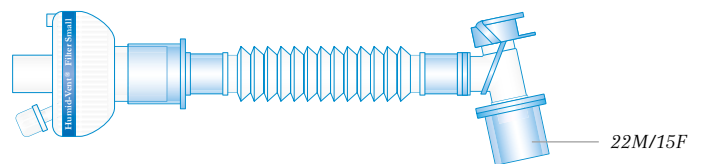



**HUMID-VENT® FILTER SMALL WITH CORRUGATED CATHETER MOUNT****WITH ELBOW CONNECTOR**

REF.	MACHINE-SIDE CONNECTOR	DESCRIPTION	LENGTH	QTY
19032	22F/15M	clean	15 cm	25

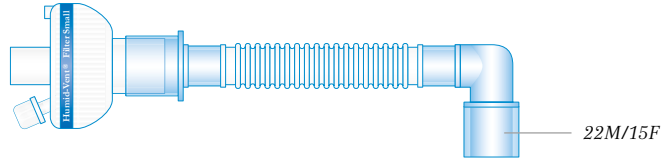
**HUMID-VENT® HEPA WITH SMOOTHBORE CATHETER MOUNT****WITH DOUBLE SIDE CONNECTOR. SEAL-AROUND PORT FOR SUCTIONING. IDEAL FOR INTENSIVE CARE UNIT.**

REF.	MACHINE-SIDE CONNECTOR	DESCRIPTION	LENGTH	QTY
29412	22F/15M	clean	15 cm	25

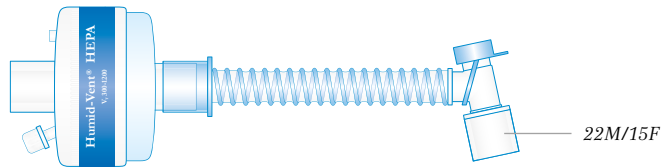
**ISO-GARD® FILTER WITH SMOOTHBORE CATHETER MOUNT****WITH FIXED COBB ELBOW AND SEALING CAP**

REF.	MACHINE-SIDE CONNECTOR	DESCRIPTION	LENGTH	QTY
191667	22F/15M	sterile	5 cm 10 cm	25

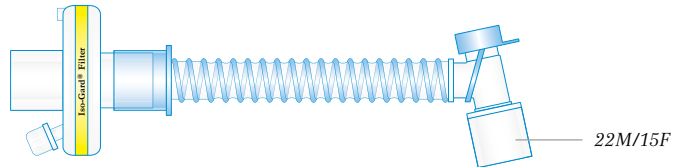
**ISO-GARD® FILTER WITH EXPANDABLE CATHETER MOUNT****WITH STRAIGHT CONNECTOR AND CAP**

REF.	MACHINE-SIDE CONNECTOR	DESCRIPTION	LENGTH	QTY
19261	22F/15M	sterile	9-15 cm	25
19262		clean	9-15 cm	25
19272 (not mounted)		clean	9-15 cm	25

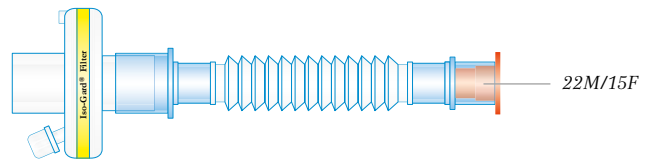
**WITH ELBOW CONNECTOR**

REF.	MACHINE-SIDE CONNECTOR	DESCRIPTION	LENGTH	QTY
19012 (not mounted)	22F/15M	sterile	9-15 cm	25

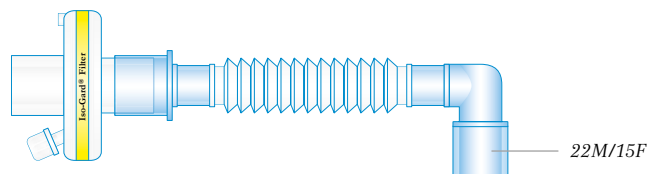

When ordering, please always indicate reference number and required length.

**ISO-GARD® FILTER SMALL WITH EXPANDABLE CATHETER MOUNT**

**WITH STRAIGHT CONNECTOR AND CAP**

REF.	MACHINE-SIDE CONNECTOR	DESCRIPTION	LENGTH	QTY
19562 (not mounted)	22F/15M	clean	9-15 cm	25

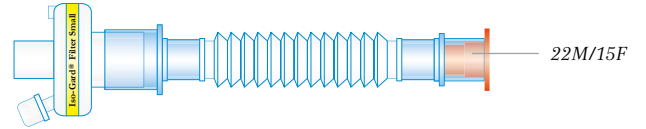

**WITH ELBOW CONNECTOR**

REF.	MACHINE-SIDE CONNECTOR	DESCRIPTION	LENGTH	QTY
19022 (not mounted)	22F/15M	clean	9-15 cm	25

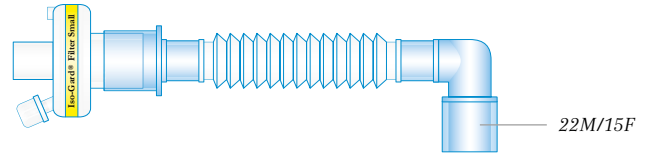

**ISO-GARD® HEPA LIGHT WITH EXPANDABLE CATHETER MOUNT**

**WITH STRAIGHT CONNECTOR AND CAP**

REF.	MACHINE-SIDE CONNECTOR	DESCRIPTION	LENGTH	QTY
28041 (not mounted)	22F/15M	sterile	9-15 cm	25
28032	22F/15M	clean	9-15 cm	25
28042 (not mounted)	22F/15M	clean	9-15 cm	25

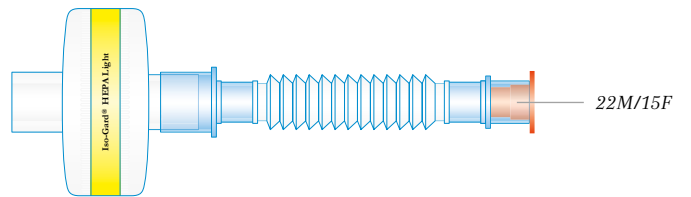

**ISO-GARD® HEPA SMALL WITH EXPANDABLE CATHETER MOUNT**

**WITH STRAIGHT CONNECTOR AND CAP**

REF.	MACHINE-SIDE CONNECTOR	DESCRIPTION	LENGTH	QTY
28081 (not mounted)	22F/15M	sterile	9-15 cm	25
28082 (not mounted)	22F/15M	clean	9-15 cm	25

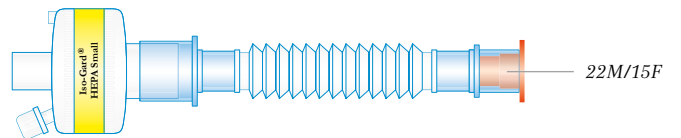

**WITH ELBOW CONNECTOR**

REF.	MACHINE-SIDE CONNECTOR	DESCRIPTION	LENGTH	QTY
28202 (not mounted)	22F/15M	sterile	9-15 cm	25

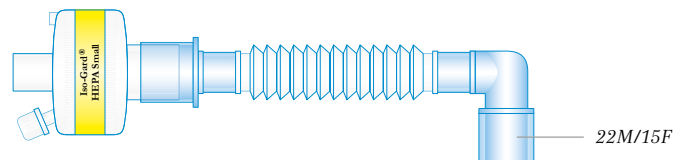

When ordering, please always indicate reference number and required length.

REF.	PAGE
027015	11
11011	7
11012	7
12011	7
12012	7
18211	9
18212	9
18401	6
18402	6
18501	6
18502	6
18511	9
18512	9
19012	17
19022	18
19032	17
19042	15
19052	16
19061	14
19062	14
19092	15
19141	15
19142	15
19211	9
19212	9
19261	17
19262	17
19272	17
19401	6
19402	6
19412	16
19432	16
19501	6
19502	6
19511	9
19512	9
19522	16
19562	18

REF.	PAGE
19612	15
19621	15
19622	15
19661	16
19662	16
19772	16
19811	14
19812	14
19882	16
28001	8
28002	8
28012	8
28022	8
28032	18
28041	18
28042	18
28051	8
28052	8
28061	8
28062	8
28081	18
28082	18
28202	18
29001	7
29002	7
29412	17
191008	10
191009	10
191010	11
191011	11
191012	11
191013	11
191014	11
191015	11
191018	10
191019	10
191020	10
191020	10

REF.	PAGE
191021	10
191022	10
191023	10
191024	10
191033	13
191034	13
191036	13
191037	13
191039	12
191040	12
191041	12
191043	12
191044	12
191045	12
191046	12
191081	13
191302	14
191345	16
191533	13
191534	13
191585	12
191586	12
191611	15
191652	11
191653	11
191654	14
191655	14
191657	14
191658	14
191667	17
191727	11
191729	11
191734	12
191735	12
191738	14
191739	14
191771	11

Teleflex is a leading global provider of specialty medical devices used for diagnostic and therapeutic procedures in critical care, urology and surgery. Our mission is to provide solutions that enable healthcare providers to improve outcomes and enhance patient and provider safety.

We specialise in devices for general and regional anaesthesia, cardiac care, respiratory care, urology, vascular access and surgery and we serve healthcare providers in more than 130 countries. Teleflex also provides specialty products for medical device manufacturers.

Our well known brands include ARROW®, BEERE MEDICAL®, DEKNATEL®, GIBECK®, HUDSON RCI®, KMEDIC®, PILLING®, PLEUR-EVAC®, RUSCH®, SHERIDAN®, SMD®, TAUT®, TFX OEM®, VASONOVA™ and WECK®, all of which are trademarks or registered trademarks of Teleflex Incorporated.

Teleflex global operations: Austria, Belgium, Canada, China, Czech Republic, France, Germany, Greece, India, Ireland, Italy, Japan, Mexico, Netherlands, Portugal, Singapore, Slovak Republic, South Africa, Spain, Switzerland, United Kingdom, Uruguay and USA.

#### **YOUR CONTACTS FOR EUROPE, THE MIDDLE EAST AND AFRICA (EMEA):**

##### **TELEFLEX MEDICAL HEADQUARTERS EMEA, IRELAND**

Teleflex Medical Europe Ltd., IDA Business Park, Athlone, Co Westmeath  
Phone +353 (0)9 06 46 08 00 · Fax +353 (0)14 37 07 73  
orders.intl@teleflex.com

**AUSTRIA** +43 (0)1 402 47 72  
**BELGIUM** +32 (0)2 333 24 60  
**CZECH REPUBLIC** +420 (0)495 759 111  
**FRANCE** +33 (0)5 62 18 79 40  
**GERMANY** +49 (0)7151 406 0  
**GREECE** +30 210 67 77 717  
**ITALY** +39 0362 58 911  
**NETHERLANDS** +31 (0)88 00 215 00  
**PORTUGAL** +351 22 541 90 85  
**SLOVAK REPUBLIC** +421 (0)3377 254 28  
**SOUTH AFRICA** +27 (0)11 807 4887  
**SPAIN** +34 918 300 451  
**SWITZERLAND** +41 (0)31 818 40 90  
**UNITED KINGDOM** +44 (0)1494 53 27 61

For detailed information see [www.teleflex.com](http://www.teleflex.com)

The products in this catalogue are only available in the EMEA (Europe, Middle East, Africa) region. For further information contact your local representative. All data current at time of printing (05/2011). Subject to technical changes without further notice.

94 04 76 - 00 00 01 · REV A · MC / WM · 05 11 03